

**P1 Relay V23026**

- Directly triggerable with TTL standard modules as ALS, HCT & ACT
- Slim line 13.5x7.85mm (0.531x0.309")
- Switching current 1 A
- Bifurcated 1 form C (CO) contact
- Immersion cleanable
- High sensitivity results in low nominal power consumption, 65 to 130mW for monostable and 30 to 150mW for bistable (latching)
- Initial surge withstand voltage  
2.5kV (2/10µs) meets the Bellcore Requirement GR-1089  
1.5kV (10/160µs) meets FCC Part 38

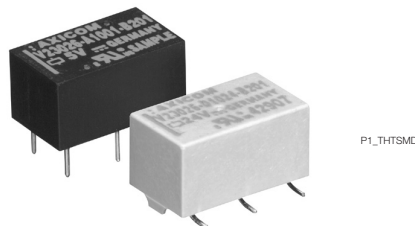

P1\_THTSMD



Typical applications  
Automotive equipment, CAN bus, immobilizer, office equipment, measurement and control equipment, medical equipment, safety equipment

**Approvals**

UL 508 File No. E 111441  
Technical data of approved types on request

**Contact Data**

Contact arrangement	1 form C (CO)
Max. switching voltage	125VDC, 150VAC
Rated current	1A
Limiting continuous current, 85°C	1A
Breaking capacity max.	see max. DC load breaking capacity
Contact material	Palladium nickel, gold-rhodium covered
Contact style	bifurcated contact
Min. recommended contact load	10mA at 20mV
Initial contact resistance	≤50mΩ at 10mA/20mV
Frequency of operation without load	200 ops./s
Operate/release time max.	2ms
Set/reset time max.	2ms
Bounce time max.	3ms
Electrical endurance	
at 12V/10mA	typ. 50x10 <sup>6</sup> operations
at 6V/100mA	typ. 10x10 <sup>6</sup> operations
at 30V/100mA	typ. 10x10 <sup>3</sup> operations
Contact ratings	
UL contact ratings	30VDC/1A
	65VDC/0.46A
	150VAC/0.46A
Mechanical endurance	typ. 10 <sup>9</sup> operations

**Max. DC load breaking capacity**

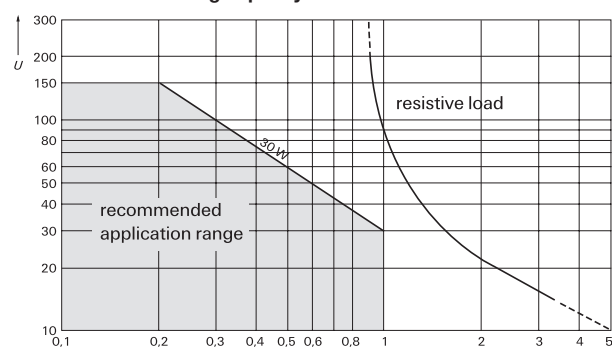

**Coil Data**

Magnetic system	polarized
Coil voltage range	3 to 24VDC
	other coil voltages on request
Operative range, IEC 61810	see coil operative range
Max. coil temperature	85°C
Thermal resistance	<130K/W

**Coil versions, THT, monostable**

Coil code	Rated voltage VDC	Operate voltage VDC	Release voltage VDC	Coil resistance Ω ±10%	Rated power mW
006	3	2.25	0.3	137	66
001	5	3.75	0.5	370	68
005	9	6.75	0.9	1165	70
002	12	9.00	1.2	2250	34
004	24	18.00	2.4	4500	128

All figures are given for coil without pre-energization, at ambient temperature +23°C.

**Coil versions, SMT, monostable**

Coil code	Rated voltage VDC	Operate voltage VDC	Release voltage VDC	Coil resistance Ω ±10%	Rated power mW
026	3	2.25	0.3	113	80
021	5	3.75	0.5	313	80
025	9	6.75	0.9	1015	80
022	12	9.00	1.2	1800	80
024	24	18.00	2.4	4500	128

All figures are given for coil without pre-energization, at ambient temperature +23°C.

**Coil operative range, monostable DC coil**

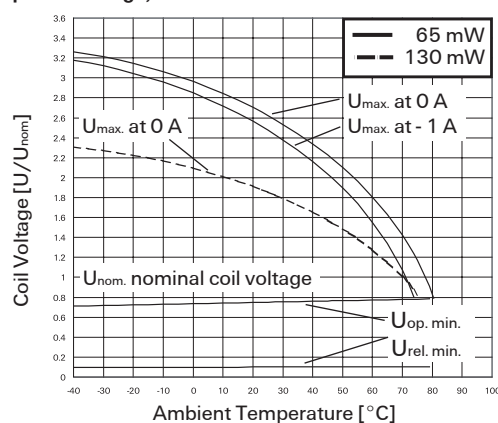

**P1 Relay V23026 (Continued)**

**Coil data (continued)**

**Coil versions, THT and SMT, bistable 2 coils**

Coil code	Rated voltage VDC	Set voltage VDC	Reset voltage VDC	Coil resistance $\Omega \pm 10\%$	Rated coil power mW
106	3	2.25	2.25	130	69
101	5	3.75	3.75	390	64
105	9	6.75	6.75	1200	68
102	12	9.00	9.00	1500	96

All figures are given for coil without pre-energization, at ambient temperature +23°C. Coils I and II are identical.

<sup>1)</sup> A nominal voltage of 24VDC is feasible with a 12VDC coil with a series resistor (1500Ω).

**Coil operative range, bistable**

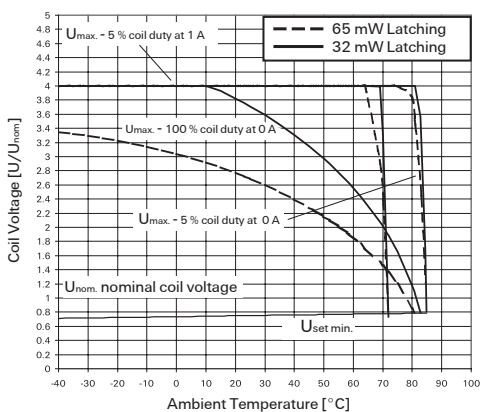

$U_{max}$  upper limit of the operative range of the coil voltage (limiting voltage) when coils are continuously energized.

$U_{op min}$  lower limit of the operative range of the coil voltage (reliable operate voltage).

$U_{rel min}$  lower limit of the operative range of the coil voltage (reliable release voltage).

**Dimensions**

**THT version**

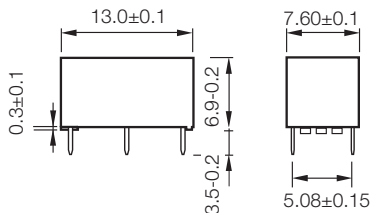

**PCB layout**

TOP view on component side of PCB

**THT version**

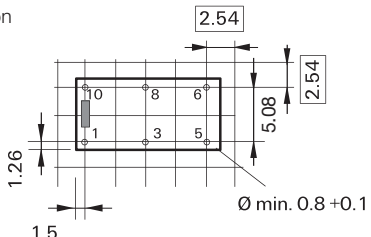

**Insulation Data**

Initial dielectric strength between open contacts	500V <sub>rms</sub>
between contact and coil	1500V <sub>rms</sub>
Initial surge withstand voltage between contact and coil	2500V
Capacitance between open contacts	max. 5pF
between contact and coil	max. 6pF
Clearance/creepage between contact and coil	0.75mm
between adjacent contacts	0.75mm

**RF Data**

Isolation at 100MHz/900MHz	-30.0dB/-18.0dB
Insertion loss at 100MHz/900MHz	-0.12dB/-1.9dB
Voltage standing wave ratio (VSWR) at 100MHz/900MHz	1.06/1.75

**Other Data**

Material compliance: EU RoHS/ELV, China RoHS, REACH, Halogen content refer to the Product Compliance Support Center at [www.tycoelectronics.com/customer-support/rohssupportcenter](http://www.tycoelectronics.com/customer-support/rohssupportcenter)

Ambient temperature -40 to +85°C

Category of environmental protection, IEC 61810 RT III - immersion cleanable

Vibration resistance (functional) 20g, 200 to 2000Hz  
40g, 10 to 200Hz

Shock resistance (functional) IEC 60068-2-27 (half sine) 50 g

Terminal type PCB terminals and SMT terminals

Weight max. 2g

Resistance to soldering heat THT IEC 60068-2-20 265 °C/10s

Resistance to soldering heat SMT IEC 60068-2-58 see reflow profile

Moisture sensitive level, JEDEC J-Std-020D MSL3

Washing not recommended

Ultrasonic cleaning possible

Packaging unit THT 2000 pcs.  
SMT 2400 pcs.

**SMT version**

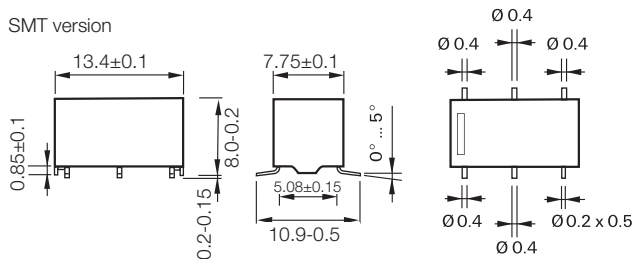

**SMT version**

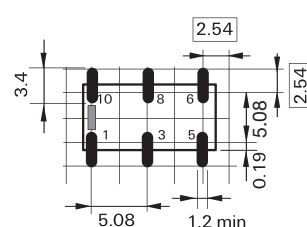

**P1 Relay V23026 (Continued)**

**Terminal assignment**

Monostable version  
rest condition

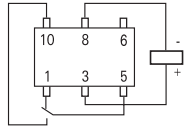

Bistable version, 1 coil  
reset condition

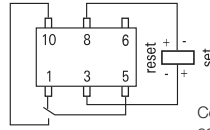

Bistable version, 2 coils  
reset condition

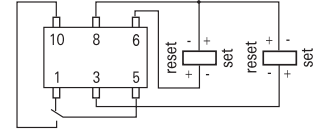

Contacts are shown in reset condition. Both coils can be used either as set or reset coil. Contact position might change during transportation and must be reset before use.

**Processing**

Recommended soldering conditions

Soldering conditions according IEC 60058-2-58 and IPC/JEDEC J-STD-020B

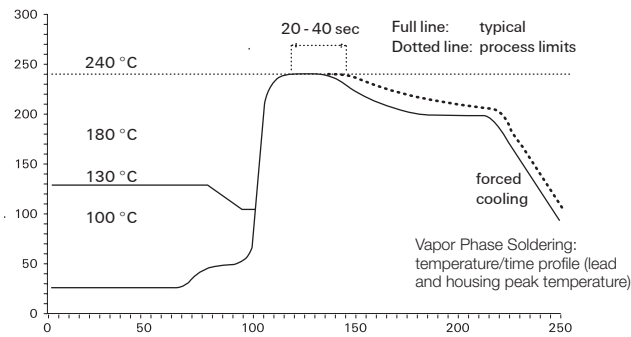

**Packing**

Tube for THT version  
40 relays per tube, 2000 relays per box

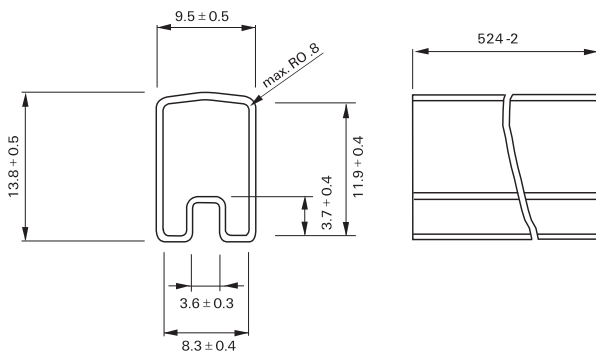

Resistance to soldering heat - Reflow profile

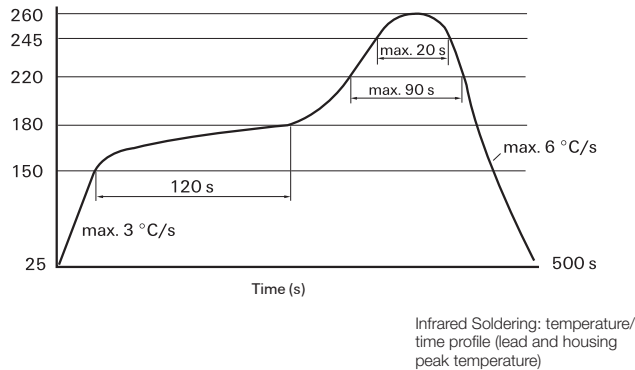

Tape and reel for SMT version  
480 relays per reel, 2400 relays per box

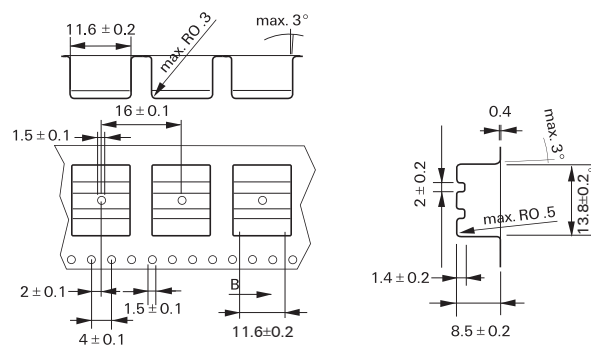

Recommended reflow soldering profile

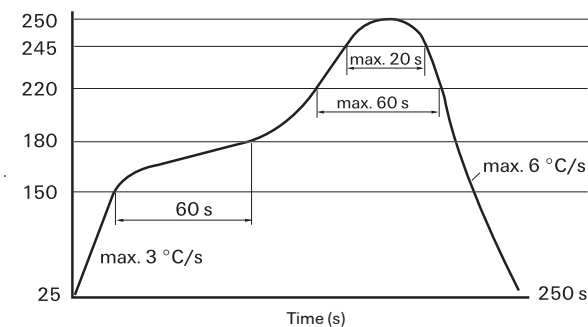

Reel dimensions

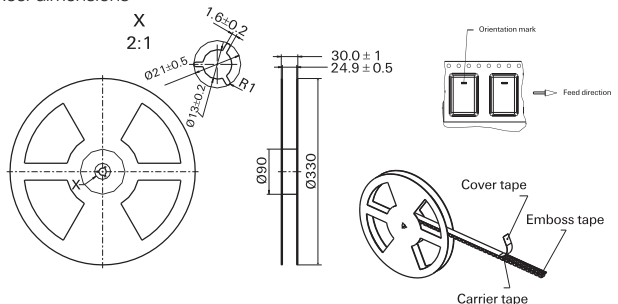

**P1 Relay V23026** (Continued)
**Product code structure**

Typical product code

**V23026****A1****002****B201****Type****V23026** P1 Series Signal Relay**Version****A1** THT, monostable**D1** SMT, monostable**B1** THT, bistable (latching), 2 coils**E1** SMT, bistable (latching), 2 coils**C1** THT, bistable (latching), 1 coil**F1** SMT, bistable (latching), 1 coil**Coil**

Coil code: please refer to coil versions table

**Contacts****B201** 1 form C, 1 CO

Product Code	Version	Coil	Coil voltage	Part Number
V23026A1006B201	THT version	monostable	3VDC	1-1393774-7
V23026A1001B201			5VDC	1393774-1
V23026A1005B201			9VDC	1-1393774-5
V23026A1002B201			12VDC	1393774-8
V23026A1004B201			24VDC	1-1393774-2
V23026B1106B201	SMT version	bistable, 2 coils	3VDC	1393775-3
V23026B1101B201			5VDC	3-1393774-4
V23026B1105B201			9VDC	1393775-2
V23026B1102B201			12VDC	3-1393774-5
V23026C1056B201			3VDC	2-1393774-6
V23026C1051B201		5VDC	2-1393774-0	
V23026C1057B201		9VDC	2-1393774-7	
V23026C1052B201		12VDC	2-1393774-1	
V23026C1054B201		24VDC	2-1393774-4	
V23026D1026B201		SMT version	monostable	3VDC
V23026D1021B201	5VDC			1393776-3
V23026D1025B201	9VDC			1422015-9
V23026D1022B201	12VDC			1393776-4
V23026D1024B201	24VDC			1393776-7
V23026E1106B201	bistable, 2 coils		3VDC	1393777-3
V23026E1101B201			5VDC	1422015-6
V23026E1105B201			9VDC	1393777-2
V23026E1102B201			12VDC	1393776-9
V23026F1051B201			9VDC	1422015-8
V23026F1052B201		12VDC	4-1393774-3	