

PKL 4000 PI series DC/DC converters, Input 36-75 V, Output 100 A/300 W	EN/LZT 146 311 R2E June 2007 © Ericsson Power Modules AB
---	---

Key Features

- “The double P” extended Half-brick
61.5 x 61.0 x 12.7 mm (2.42 x 2.40 x 0.50 in.)
- High efficiency, typ. 88 % at 1.8 V out full load
- 1500 Vdc input to output isolation
- Meets isolation requirements equivalent to basic insulation according to IEC/EN/UL 60950
- Low output ripple, 60 mVp-p typ.



General Characteristics

- Used in inter-networking equipment in Wireless and Wired communications and Datacom applications
- Output over voltage protection
- Input under voltage protection
- Over temperature protection
- Soft start
- Output short-circuit protection
- Remote sense
- Remote control
- Output voltage adjust function
- Highly automated manufacturing ensures quality
- ISO 9001/14001 certified supplier

Safety Approvals



Design for Environment



Meets requirements in high-temperature lead-free soldering processes.

Contents

General Information	2
Safety Specification	3
Absolute Maximum Ratings	4
Product Program	Ordering No.
1.8 V/60 A Electrical Specification	PKL 4118 PIT 5
1.8 V/80 A Electrical Specification	PKL 4118B PIT 8
1.8 V/100 A Electrical Specification	PKL 4118A PIT 11
2.5 V/60 A Electrical Specification	PKL 4119A PIT 14
2.5 V/80 A Electrical Specification	PKL 4219A PIT 17
3.3 V/50 A Electrical Specification	PKL 4110 PIT 20
3.3 V/60 A Electrical Specification	PKL 4110A PIT 23
5 V/60 A Electrical Specification	PKL 4311 PIT 26
12 V/25 A Electrical Specification	PKL 4313 PIT 29
EMC Specification	32
Operating Information	33
Thermal Consideration	34
Connections	35
Mechanical Information	36
Soldering Information	37
Delivery Information	37
Product Qualification Specification	38

PKL 4000 PI series
DC/DC converters, Input 36-75 V, Output 100 A/300 W

EN/LZT 146 311 R2E June 2007

© Ericsson Power Modules AB

General Information

Ordering Information

See Contents for individual product ordering numbers.

Option	Suffix	Ordering No.
Positive Remote Control Logic	P	PKL 4219A PIPT
Lead length 3.69 mm (0.145 in)	LA	PKL 4118B PITLA
Lead length 4.57 mm (0.180 in)	LB	PKL 4118B PITLB
Lead length 2.80 mm (0.11 in)	LC	PKL 4118B PITLC

Note: As an example a positive logic, short pin product would be PKL 4118B PIPTLA

Reliability

The Mean Time Between Failure (MTBF) is calculated at full output power and an operating ambient temperature (T_A) of +40°C. Different methods could be used to calculate the predicted MTBF and failure rate which may give different results. Ericsson Power Modules currently uses two different methods, Ericsson failure rate data system DependTool and Telcordia SR332.

Predicted MTBF for the series is:

- 2.2 million hours according to DependTool.
- 1.05 million hours according to TelCordia SR332, issue 1, Black box technique.

The Ericsson failure rate data system is based on field tracking data. The data corresponds to actual failure rates of components used in Information Technology and Telecom (IT&T) equipment in temperature controlled environments ($T_A = -5...+65^\circ\text{C}$). Telcordia SR332 is a commonly used standard method intended for reliability calculations in IT&T equipment. The parts count procedure used in this method was originally modelled on the methods from MIL-HDBK-217F, Reliability Predictions of Electronic Equipment.

It assumes that no reliability data is available on the actual units and devices for which the predictions are to be made, i.e. all predictions are based on generic reliability parameters.

Compatibility with RoHS requirements

The products are compatible with the relevant clauses and requirements of the RoHS directive 2002/95/EC and have a maximum concentration value of 0.1% by weight in homogeneous materials for lead, mercury, hexavalent chromium, PBB and PBDE and of 0.01% by weight in homogeneous materials for cadmium.

Exemptions in the RoHS directive utilized in Ericsson Power Modules products include:

- Lead in high melting temperature type solder (used to solder the die in semiconductor packages)
- Lead in glass of electronics components and in electronic ceramic parts (e.g. fill material in chip resistors)
- Lead as an alloying element in copper alloy containing up to 4% lead by weight (used in connection pins made of Brass)

Quality Statement

The products are designed and manufactured in an industrial environment where quality systems and methods like ISO 9000, 6 σ (sigma), and SPC are intensively in use to boost the continuous improvements strategy. Infant mortality or early failures in the products are screened out and they are subjected to an ATE-based final test. Conservative design rules, design reviews and product qualifications, plus the high competence of an engaged work force, contribute to the high quality of our products.

Warranty

Warranty period and conditions are defined in Ericsson Power Modules General Terms and Conditions of Sale.

Limitation of Liability

Ericsson Power Modules does not make any other warranties, expressed or implied including any warranty of merchantability or fitness for a particular purpose (including, but not limited to, use in life support applications, where malfunctions of product can cause injury to a person's health or life).

PKL 4000 PI series
DC/DC converters, Input 36-75 V, Output 100 A/300 W

EN/LZT 146 311 R2E June 2007

© Ericsson Power Modules AB

Safety Specification

General information

Ericsson Power Modules DC/DC converters and DC/DC regulators are designed in accordance with safety standards IEC/EN/UL60950, *Safety of Information Technology Equipment*.

IEC/EN/UL60950 contains requirements to prevent injury or damage due to the following hazards:

- Electrical shock
- Energy hazards
- Fire
- Mechanical and heat hazards
- Radiation hazards
- Chemical hazards

On-board DC-DC converters are defined as component power supplies. As components they cannot fully comply with the provisions of any Safety requirements without "Conditions of Acceptability". It is the responsibility of the installer to ensure that the final product housing these components complies with the requirements of all applicable Safety standards and Directives for the final product.

Component power supplies for general use should comply with the requirements in IEC60950, EN60950 and UL60950 "Safety of information technology equipment".

There are other more product related standards, e.g. IEEE802.3af "Ethernet LAN/MAN Data terminal equipment power", and ETS300132-2 "Power supply interface at the input to telecommunications equipment; part 2: DC", but all of these standards are based on IEC/EN/UL60950 with regards to safety.

Ericsson Power Modules DC/DC converters and DC/DC regulators are UL60950 recognized and certified in accordance with EN60950.

The flammability rating for all construction parts of the products meets requirements for V-0 class material according to IEC 60695-11-10.

The products should be installed in the end-use equipment, in accordance with the requirements of the ultimate application. Normally the output of the DC/DC converter is considered as SELV (Safety Extra Low Voltage) and the input source must be isolated by minimum Double or Reinforced Insulation from the primary circuit (AC mains) in accordance with IEC/EN/UL60950.

Isolated DC/DC converters

It is recommended that a slow blow fuse with a rating twice the maximum input current per selected product be used at the input of each DC/DC converter. If an input filter is used in the circuit the fuse should be placed in front of the input filter.

In the rare event of a component problem in the input filter or in the DC/DC converter that imposes a short circuit on the input source, this fuse will provide the following functions:

- Isolate the faulty DC/DC converter from the input power source so as not to affect the operation of other parts of the system.
- Protect the distribution wiring from excessive current and power loss thus preventing hazardous overheating.

The galvanic isolation is verified in an electric strength test. The test voltage (V_{iso}) between input and output is 1500 Vdc or 2250 Vdc for 60 seconds (refer to product specification).

Leakage current is less than 1 μ A at nominal input voltage.

24 V DC systems

The input voltage to the DC/DC converter is SELV (Safety Extra Low Voltage) and the output remains SELV under normal and abnormal operating conditions.

48 and 60 V DC systems

If the input voltage to Ericsson Power Modules DC/DC converter is 75 Vdc or less, then the output remains SELV (Safety Extra Low Voltage) under normal and abnormal operating conditions.

Single fault testing in the input power supply circuit should be performed with the DC/DC converter connected to demonstrate that the input voltage does not exceed 75 Vdc.

If the input power source circuit is a DC power system, the source may be treated as a TNV2 circuit and testing has demonstrated compliance with SELV limits and isolation requirements equivalent to Basic Insulation in accordance with IEC/EN/UL60950.

Non-isolated DC/DC regulators

The input voltage to the DC/DC regulator is SELV (Safety Extra Low Voltage) and the output remains SELV under normal and abnormal operating conditions.

PKL 4000 PI series DC/DC converters, Input 36-75 V, Output 100 A/300 W	EN/LZT 146 311 R2E June 2007 © Ericsson Power Modules AB
---	---

Absolute Maximum Ratings

Characteristics		min	typ	max	Unit
T_{ref}	Operating Temperature (see Thermal Consideration section)	-40		+100	°C
T_S	Storage temperature	-55		+125	°C
V_I	Input voltage	-0.5		+80	V
V_{iso}	Isolation voltage (input to output test voltage)			1500	Vdc
V_{tr}	Input voltage transient (T_p 100 ms)			100	V
V_{RC}	Remote Control pin voltage (see Operating Information section)	Positive logic option		15	V
		Negative logic option	-0.5	15	V
V_{adj}	Adjust pin voltage (see Operating Information section)	-0.5		$2 \times V_{oi}$	V

Stress in excess of Absolute Maximum Ratings may cause permanent damage. Absolute Maximum Ratings, sometimes referred to as no destruction limits, are normally tested with one parameter at a time exceeding the limits of Output data or Electrical Characteristics. If exposed to stress above these limits, function and performance may degrade in an unspecified manner.

Fundamental Circuit Diagram

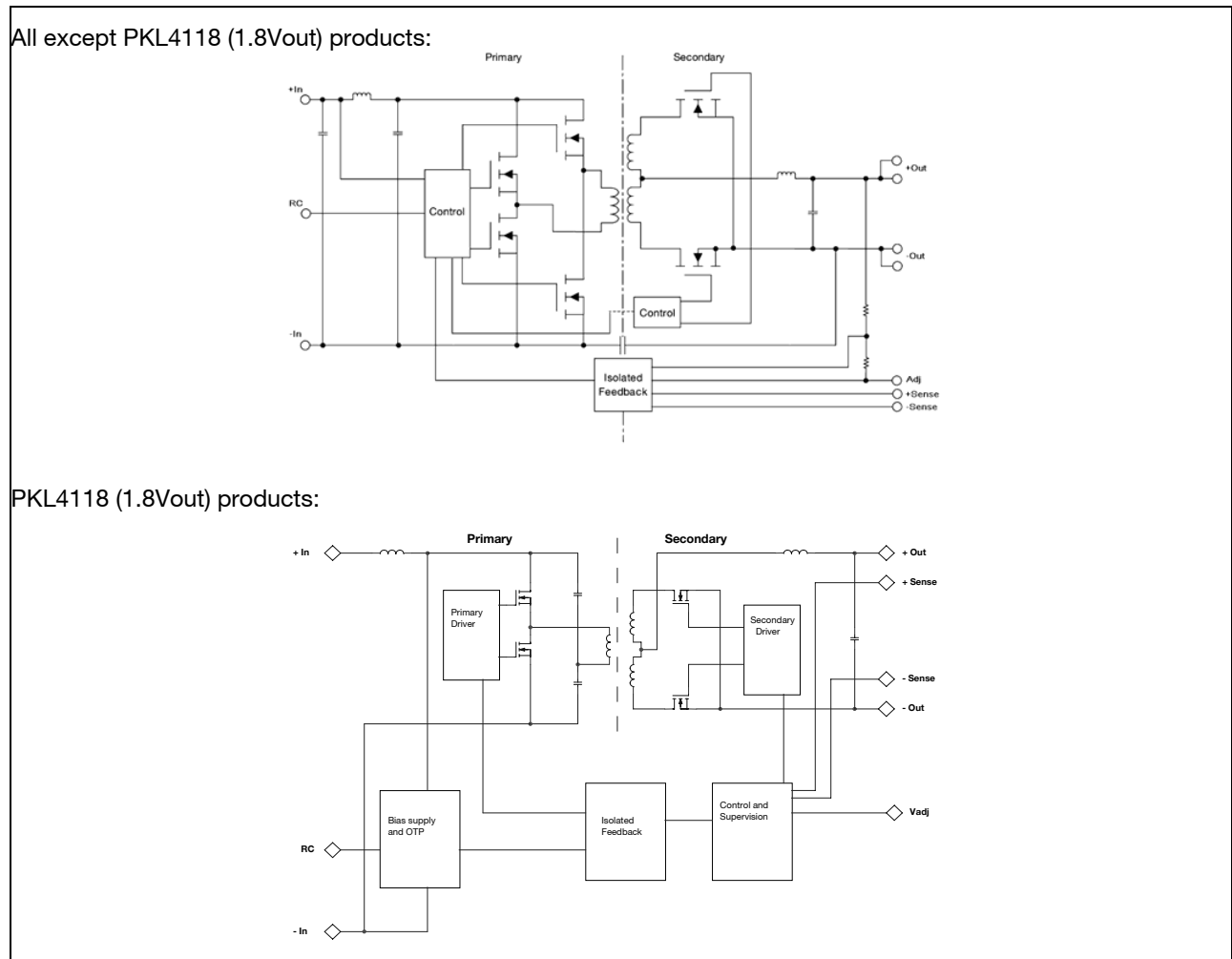

PKL 4000 PI series DC/DC converters, Input 36-75 V, Output 100 A/300 W	EN/LZT 146 311 R2E June 2007
	© Ericsson Power Modules AB

1.8 V/60 A Electrical Specification
PKL 4118 PIT

$T_{ref} = -40$ to $+100^{\circ}\text{C}$, $V_I = 36$ to 75 V, sense pins connected to output pins unless otherwise specified under Conditions.
Typical values given at: $T_{ref} = +25^{\circ}\text{C}$, $V_I = 53$ V, max I_O , unless otherwise specified under Conditions.

Characteristics		Conditions	min	typ	max	Unit
V_I	Input voltage range		36		75	V
V_{loff}	Turn-off input voltage	Decreasing input voltage	30	32.5	35	V
V_{lon}	Turn-on input voltage	Increasing input voltage	32	34.5	36	V
C_I	Internal input capacitance			2.18		μF
P_O	Output power	Output voltage initial setting	0		108	W
SVR	Supply voltage rejection (ac)	$f = 100$ Hz sinewave, 1 Vp-p		53		dB
η	Efficiency	50 % of max I_O		90		%
		max I_O		88		
		50 % of max I_O , $V_I = 48$ V		TBD		
		max I_O , $V_I = 48$ V		TBD		
P_d	Power Dissipation	max I_O		15		W
P_{II}	Input idling power	$I_O = 0$ A, $V_I = 53$ V		3.7		W
P_{RC}	Input standby power	$V_I = 53$ V (turned off with RC)		0.34		W
f_s	Switching frequency	0-100 % of max I_O		150		kHz

V_{O1}	Output voltage initial setting and accuracy	$T_{ref} = +25^{\circ}\text{C}$, $V_I = 53$ V, $I_O = 60$ A	1.77	1.80	1.83	V
V_O	Output adjust range	See operating information	1.44		2.00	V
	Output voltage tolerance band	10-100% of max I_O	1.746		1.854	V
	Idling voltage	$I_O = 0$ A	1.746		1.900	V
	Line regulation	max I_O		5	15	mV
	Load regulation	$V_I = 53$ V, 0-100% of max I_O		5	15	mV
V_{tr}	Load transient voltage deviation	$V_I = 53$ V, Load step 25-50-25 % of max I_O , $di/dt = 1$ A/ μs ,		± 200		mV
t_{tr}	Load transient recovery time			100		μs
t_r	Ramp-up time (from 10-90 % of V_{O1})	10-100% of max I_O		12	16	ms
t_s	Start-up time (from V_I connection to 90% of V_{O1})			16	20	ms
t_f	V_{in} shutdown fall time (from V_I off to 10% of V_O)	max I_O		N/A		ms
		$I_O = 0$ A		N/A		s
t_{RC}	RC start-up time	max I_O		N/A		ms
		max I_O		N/A		ms
		$I_O = 0$ A		N/A		s
I_O	Output current		0		60	A
I_{lim}	Current limit threshold	$T_{ref} < \max T_{ref}$	64	66	68	A
I_{sc}	Short circuit current	$T_{ref} = 25^{\circ}\text{C}$, see Note 1	69	74	78	A
V_{Oac}	Output ripple & noise	See ripple & noise section, max I_O , V_{O1}		50	100	mVp-p
OVP	Over voltage protection	$T_{ref} = +25^{\circ}\text{C}$, $V_I = 53$ V, 0-100% of max I_O		2.51	2.9	V

Note 1: See Operating Information section.

PKL 4000 PI series DC/DC converters, Input 36-75 V, Output 100 A/300 W	EN/LZT 146 311 R2E June 2007 © Ericsson Power Modules AB
---	---

1.8 V/60 A Typical Characteristics

PKL 4118 PIT

Efficiency

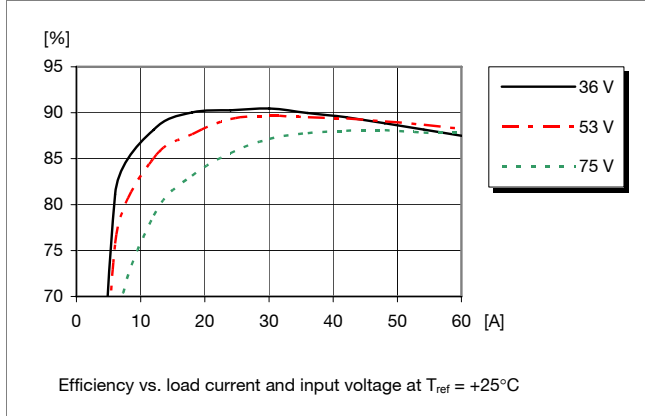

Power Dissipation

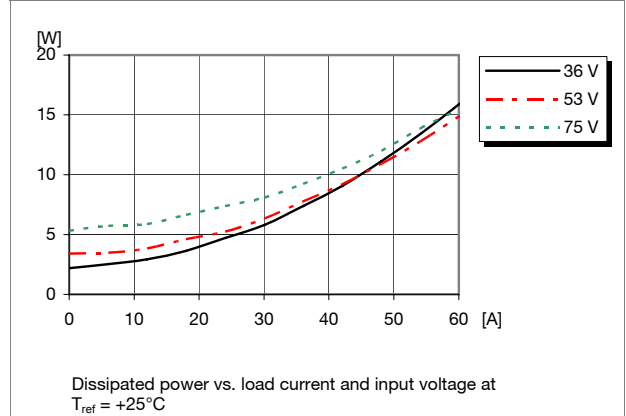

Output Current Derating

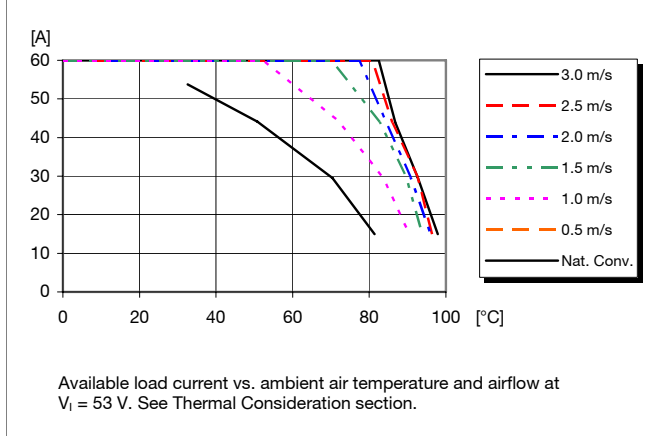

Thermal Resistance

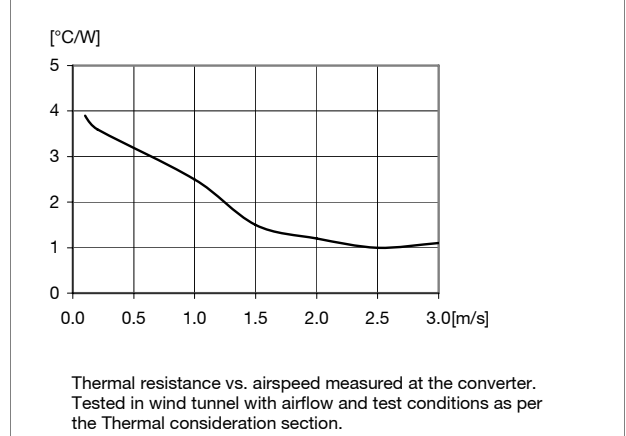

Output Characteristics

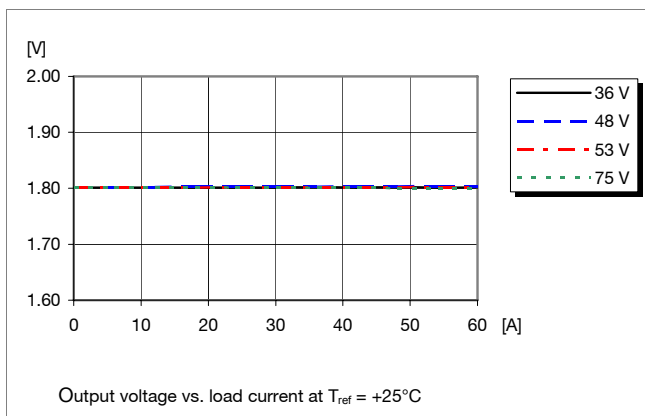

Current Limit Characteristics

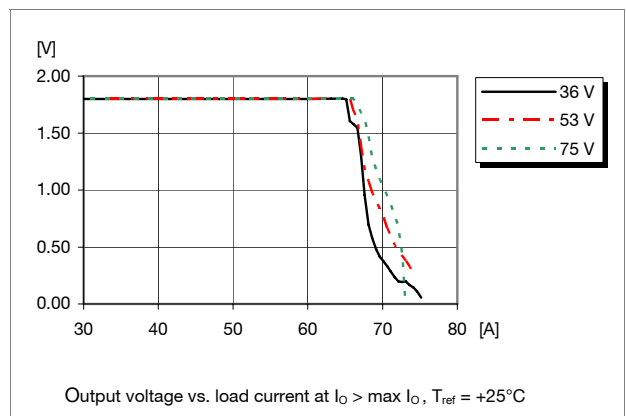

PKL 4000 PI series
DC/DC converters, Input 36-75 V, Output 100 A/300 W

EN/LZT 146 311 R2E June 2007
© Ericsson Power Modules AB

1.8 V/60 A Typical Characteristics

PKL 4118 PIT

Start-up

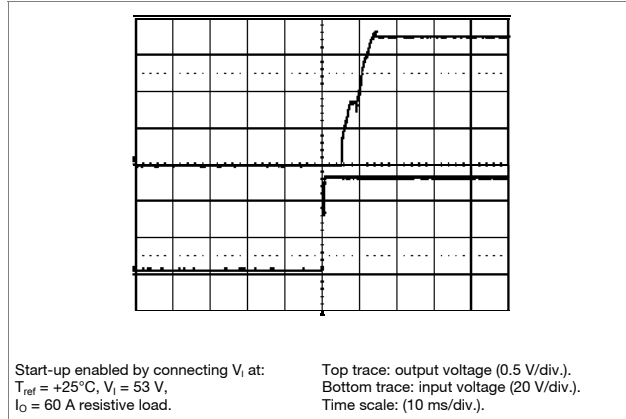

Shut-down

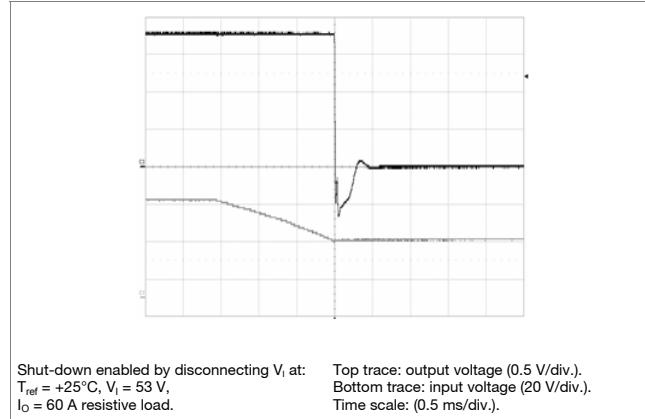

Output Ripple & Noise

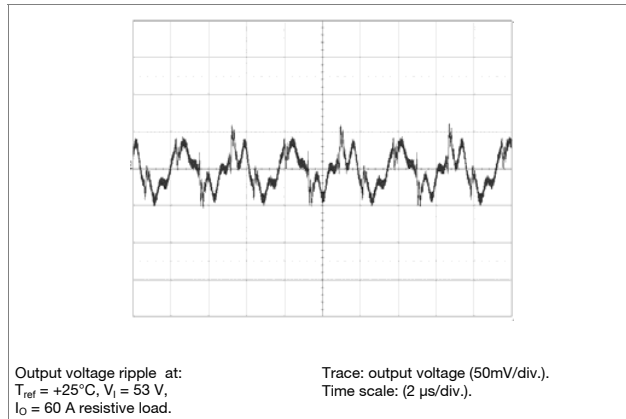

Output Load Transient Response

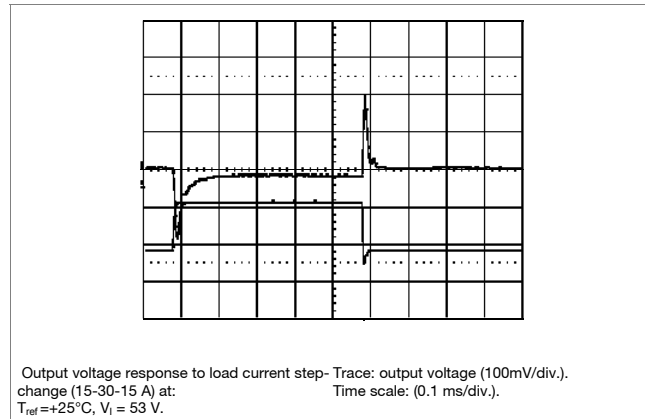

Output Voltage Adjust (see operating information)

Passive adjust

The resistor value for an adjusted output voltage is calculated by using the following equations:

Output Voltage Adjust Upwards, Increase:

$$R_{adj} = [(V_o(100+\Delta\%)/(1.225\Delta\%)-(100+2\Delta\%)/\Delta\%)] \text{ k}\Omega$$

Eg Increase 5% => $V_{out} = 1.89\text{ Vdc}$

$$1.8(100+5)/(1.225 \times 5) - (100+2 \times 5)/5 = 8.8 \text{ k}\Omega$$

Output Voltage Adjust Downwards, Decrease:

$$R_{adj} = (100 / \Delta\% - 2) \text{ k}\Omega$$

Eg Decrease 5% => $V_{out} = 1.71\text{ Vdc}$

$$(100/5-2) = 18 \text{ k}\Omega$$

PKL 4000 PI series DC/DC converters, Input 36-75 V, Output 100 A/300 W	EN/LZT 146 311 R2E June 2007 © Ericsson Power Modules AB
---	---

1.8 V/80 A Electrical Specification
PKL 4118 BPIT

$T_{ref} = -40$ to $+100^{\circ}\text{C}$, $V_I = 36$ to 75 V, sense pins connected to output pins unless otherwise specified under Conditions.
 Typical values given at: $T_{ref} = +25^{\circ}\text{C}$, $V_I = 53$ V, max I_O , unless otherwise specified under Conditions.

Characteristics		Conditions	min	typ	max	Unit
V_I	Input voltage range		36		75	V
V_{loff}	Turn-off input voltage	Decreasing input voltage	30	32.5	35	V
V_{lon}	Turn-on input voltage	Increasing input voltage	32	34.5	36	V
C_I	Internal input capacitance			2.18		μF
P_O	Output power	Output voltage initial setting	0		144	W
SVR	Supply voltage rejection (ac)	$f = 100$ Hz sinewave, 1 Vp-p		53		dB
η	Efficiency	50 % of max I_O		89		%
		max I_O		85		
		50 % of max I_O , $V_I = 48$ V		89		
		max I_O , $V_I = 48$ V		85		
P_d	Power Dissipation	max I_O		25		W
P_{II}	Input idling power	$I_O = 0$ A, $V_I = 53$ V		3.7		W
P_{RC}	Input standby power	$V_I = 53$ V (turned off with RC)		0.33		W
f_s	Switching frequency	0-100 % of max I_O		150		kHz

V_{Oi}	Output voltage initial setting and accuracy	$T_{ref} = +25^{\circ}\text{C}$, $V_I = 53$ V, $I_O = 80$ A	1.77	1.80	1.83	V
V_O	Output adjust range	See operating information	1.44		2.00	V
	Output voltage tolerance band	10-100% of max I_O	1.746		1.854	V
	Idling voltage	$I_O = 0$ A	1.746		1.900	V
	Line regulation	max I_O		5	15	mV
	Load regulation	$V_I = 53$ V, 0-100% of max I_O		5	15	mV
V_{tr}	Load transient voltage deviation	$V_I = 53$ V, Load step 25-50-25 % of max I_O , $di/dt = 1$ A/ μs ,		± 200		mV
t_{tr}	Load transient recovery time			100		μs
t_r	Ramp-up time (from 10-90 % of V_{Oj})	10-100% of max I_O		16	20	ms
t_s	Start-up time (from V_I connection to 90% of V_{Oj})			20	30	ms
t_f	V_{in} shutdown fall time (from V_I off to 10% of V_{Oj})	max I_O		N/A		ms
		$I_O = 0$ A		N/A		s
t_{RC}	RC start-up time	max I_O		10		ms
	RC shutdown fall time (from RC off to 10% of V_{Oj})	max I_O		N/A		ms
		$I_O = 0$ A		N/A		s
I_O	Output current		0		80	A
I_{lim}	Current limit threshold	$T_{ref} < \max T_{ref}$	92.5	93.0	93.5	A
I_{sc}	Short circuit current	$T_{ref} = 25^{\circ}\text{C}$, see Note 1	96	97	98	A
V_{Oac}	Output ripple & noise	See ripple & noise section, max I_O , V_{Oj}		100	150	mVp-p
OVP	Over voltage protection	$T_{ref} = +25^{\circ}\text{C}$, $V_I = 53$ V, 0-100% of max I_O		2.51	2.9	V

Note 1: See Operating Information section.

PKL 4000 PI series DC/DC converters, Input 36-75 V, Output 100 A/300 W	EN/LZT 146 311 R2E June 2007 © Ericsson Power Modules AB
---	---

1.8 V/80 A Typical Characteristics

PKL 4118 BPIT

Efficiency

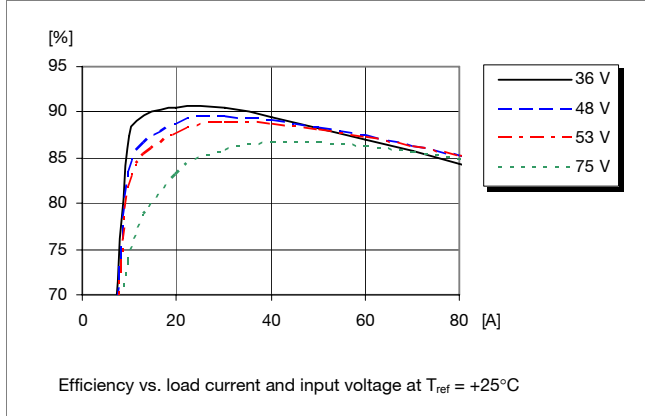

Power Dissipation

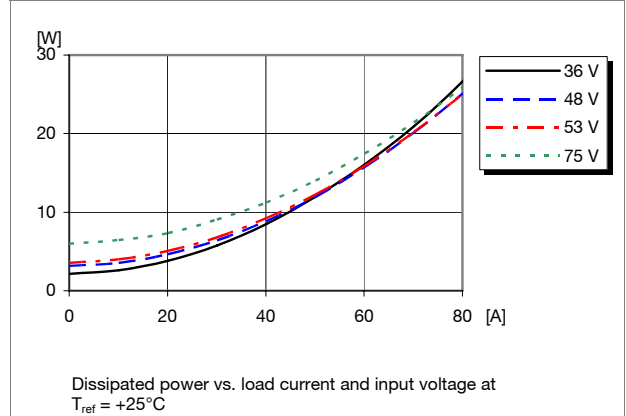

Output Current Derating

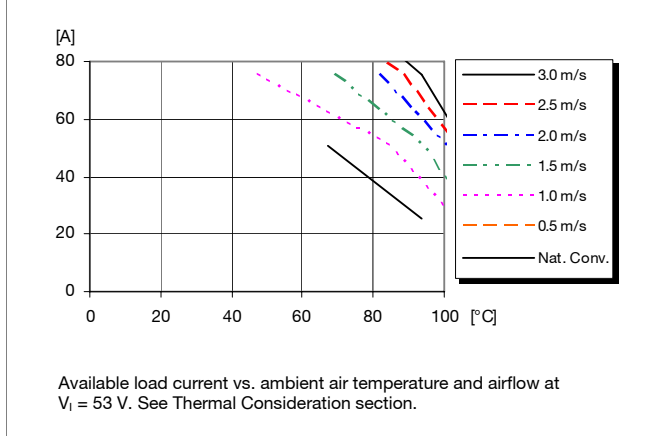

Thermal Resistance

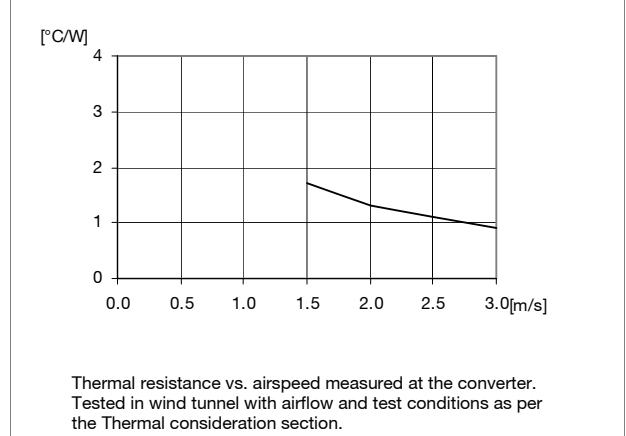

Output Characteristics

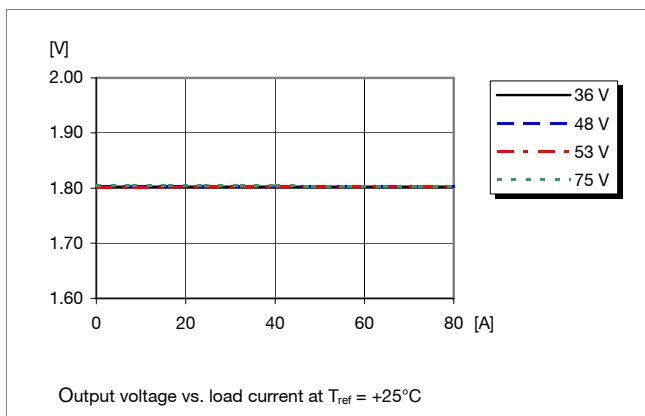

Current Limit Characteristics

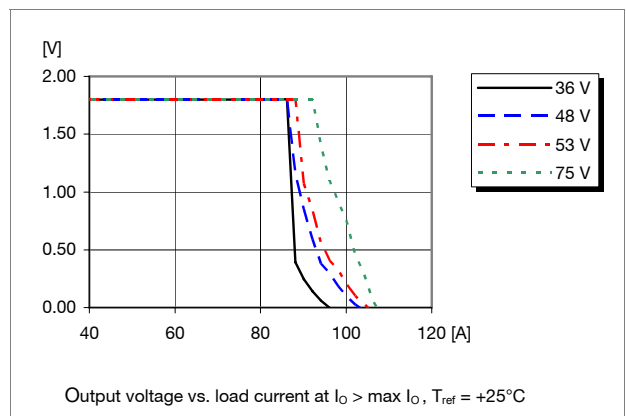

PKL 4000 PI series
DC/DC converters, Input 36-75 V, Output 100 A/300 W

EN/LZT 146 311 R2E June 2007
© Ericsson Power Modules AB

1.8 V/80 A Typical Characteristics

PKL 4118 BPIT

Start-up

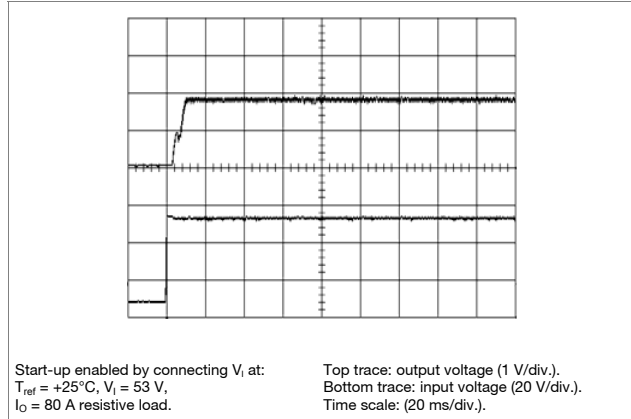

Shut-down

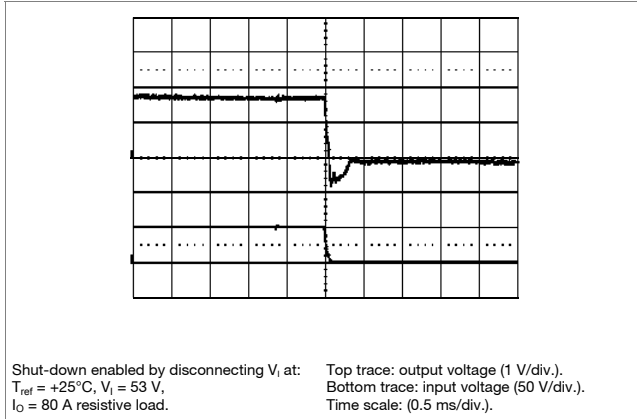

Output Ripple & Noise

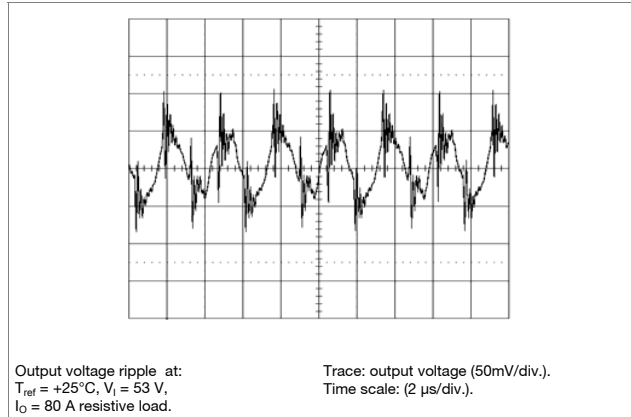

Output Load Transient Response

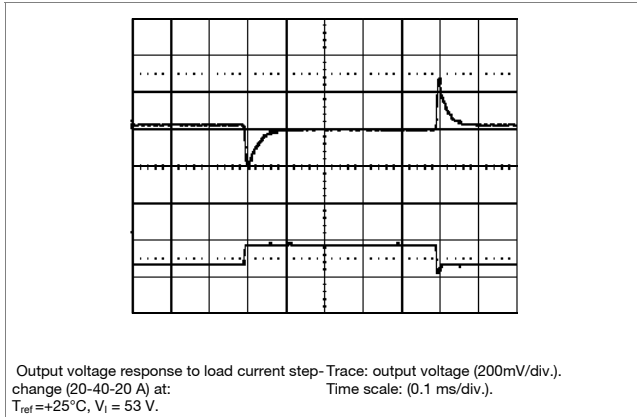

Output Voltage Adjust (see operating information)

Passive adjust

The resistor value for an adjusted output voltage is calculated by using the following equations:

Output Voltage Adjust Upwards, Increase:

$$R_{adj} = [(V_o(100+\Delta\%)/(1.225\Delta\%)-(100+2\Delta\%)/\Delta\%) \text{ k}\Omega$$

Eg Increase 5% => $V_{out} = 1.89\text{ Vdc}$
 $1.8(100+5)/(1.225 \times 5) - (100+2 \times 5)/5 = 8.8\text{ k}\Omega$

Output Voltage Adjust Downwards, Decrease:

$$R_{adj} = (100 / \Delta\% - 2) \text{ k}\Omega$$

Eg Decrease 5% => $V_{out} = 1.71\text{ Vdc}$
 $(100/5 - 2) = 18\text{ k}\Omega$

PKL 4000 PI series DC/DC converters, Input 36-75 V, Output 100 A/300 W	EN/LZT 146 311 R2E June 2007
	© Ericsson Power Modules AB

1.8 V/100 A Electrical Specification
PKL 4118 APIT

$T_{ref} = -40$ to $+100^{\circ}\text{C}$, $V_i = 36$ to 75 V, sense pins connected to output pins unless otherwise specified under Conditions.
Typical values given at: $T_{ref} = +25^{\circ}\text{C}$, $V_i = 53$ V, max I_o , unless otherwise specified under Conditions.

Characteristics		Conditions	min	typ	max	Unit
V_i	Input voltage range		36		75	V
V_{loff}	Turn-off input voltage	Decreasing input voltage	30	32.5	35	V
V_{lon}	Turn-on input voltage	Increasing input voltage	32	34.5	36	V
C_i	Internal input capacitance			2.18		μF
P_o	Output power	Output voltage initial setting	0		180	W
SVR	Supply voltage rejection (ac)	$f = 100$ Hz sinewave, 1 Vp-p		53		dB
η	Efficiency	50 % of max I_o		88		%
		max I_o		83		
		50 % of max I_o , $V_i = 48$ V		88		
		max I_o , $V_i = 48$ V		83		
P_d	Power Dissipation	max I_o		37		W
P_{ii}	Input idling power	$I_o = 0$ A, $V_i = 53$ V		3.7		W
P_{RC}	Input standby power	$V_i = 53$ V (turned off with RC)		0.33		W
f_s	Switching frequency	0-100 % of max I_o		150		kHz

V_{oi}	Output voltage initial setting and accuracy	$T_{ref} = +25^{\circ}\text{C}$, $V_i = 53$ V, $I_o = 100$ A	1.77	1.80	1.83	V
V_o	Output adjust range	See operating information	1.44		2.00	V
	Output voltage tolerance band	10-100% of max I_o	1.746		1.854	V
	Idling voltage	$I_o = 0$ A	1.746		1.900	V
	Line regulation	max I_o		5	15	mV
	Load regulation	$V_i = 53$ V, 0-100% of max I_o		5	15	mV
V_{tr}	Load transient voltage deviation	$V_i = 53$ V, Load step 25-50-25 % of max I_o , $di/dt = 1$ A/ μs ,		± 200		mV
t_{tr}	Load transient recovery time			50		μs
t_r	Ramp-up time (from 10-90 % of V_{oi})	10-100% of max I_o		16	20	ms
t_s	Start-up time (from V_i connection to 90% of V_{oi})			20	30	ms
t_f	V_{in} shutdown fall time (from V_i off to 10% of V_o)	max I_o		N/A		ms
		$I_o = 0$ A		N/A		s
t_{RC}	RC start-up time	max I_o		10		ms
		max I_o		N/A		ms
		$I_o = 0$ A		N/A		s
I_o	Output current		0		100	A
I_{lim}	Current limit threshold	$T_{ref} < \max T_{ref}$		110	128	A
I_{sc}	Short circuit current	$T_{ref} = 25^{\circ}\text{C}$, see Note 1		125	135	A
V_{Oac}	Output ripple & noise	See ripple & noise section, max I_o , V_{oi}		100	150	mVp-p
OVP	Over voltage protection	$T_{ref} = +25^{\circ}\text{C}$, $V_i = 53$ V, 0-100% of max I_o		2.51	2.9	V

Note 1: See Operating Information section.

PKL 4000 PI series DC/DC converters, Input 36-75 V, Output 100 A/300 W	EN/LZT 146 311 R2E June 2007 © Ericsson Power Modules AB
---	---

1.8 V/100 A Typical Characteristics

PKL 4118 APIT

Efficiency

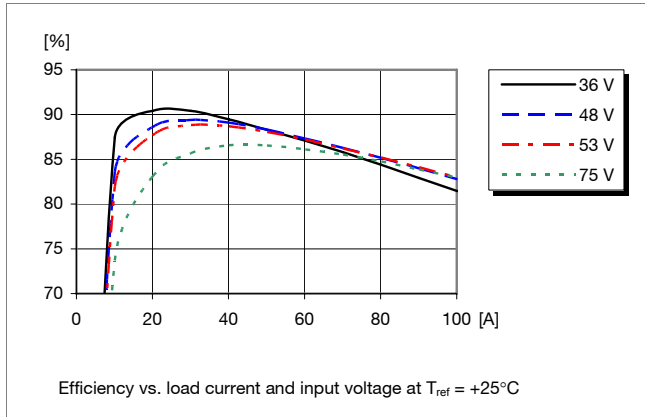

Power Dissipation

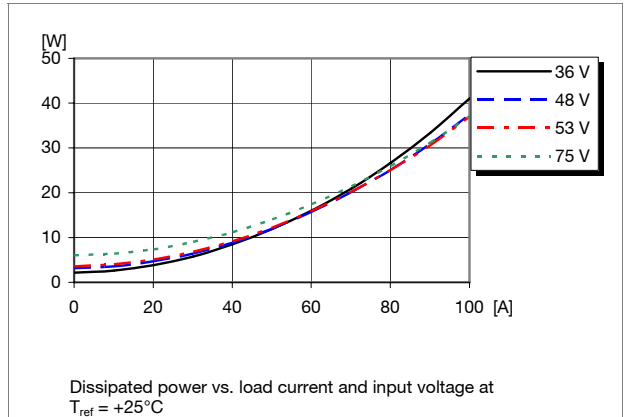

Output Current Derating

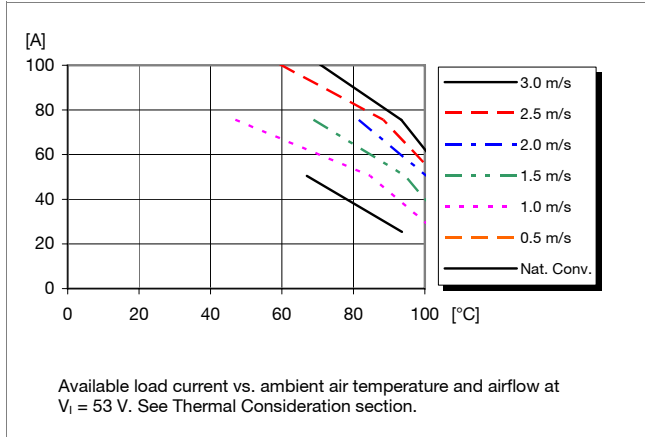

Thermal Resistance

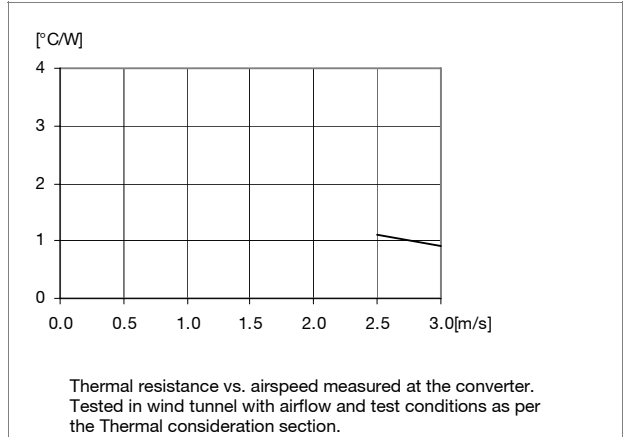

Output Characteristics

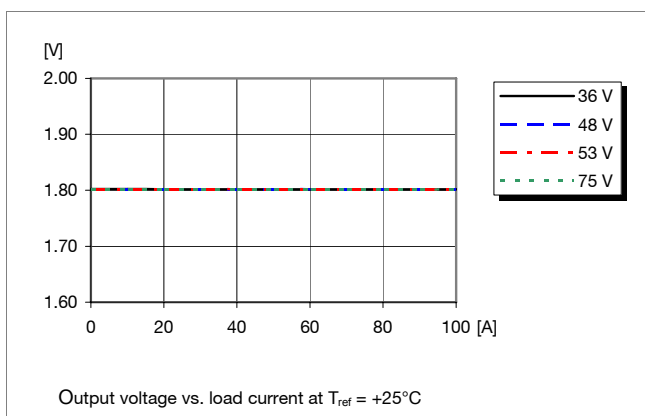

Current Limit Characteristics

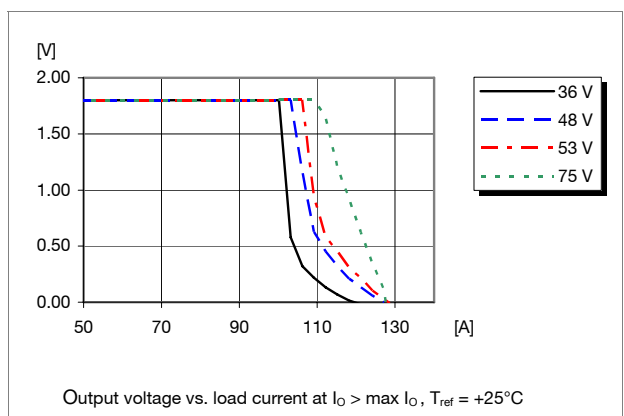

PKL 4000 PI series
DC/DC converters, Input 36-75 V, Output 100 A/300 W

EN/LZT 146 311 R2E June 2007
© Ericsson Power Modules AB

1.8 V/100 A Typical Characteristics

PKL 4118 APIT

Start-up

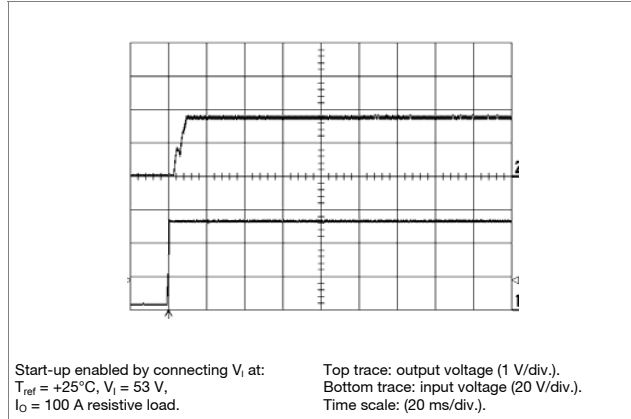

Shut-down

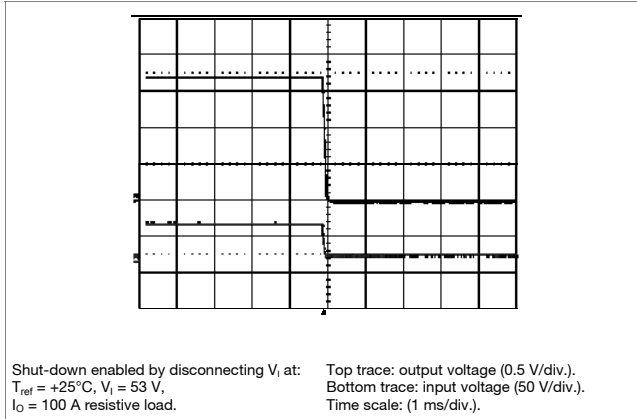

Output Ripple & Noise

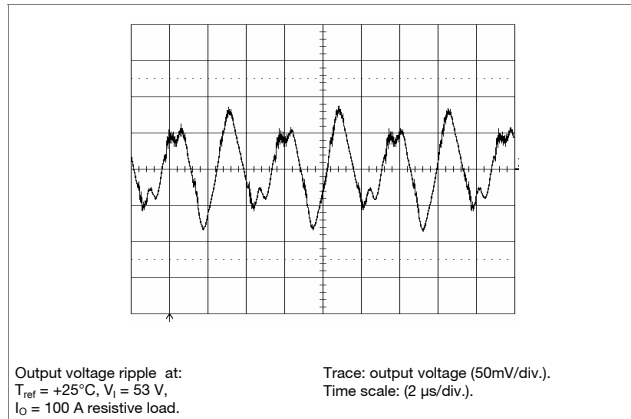

Output Load Transient Response

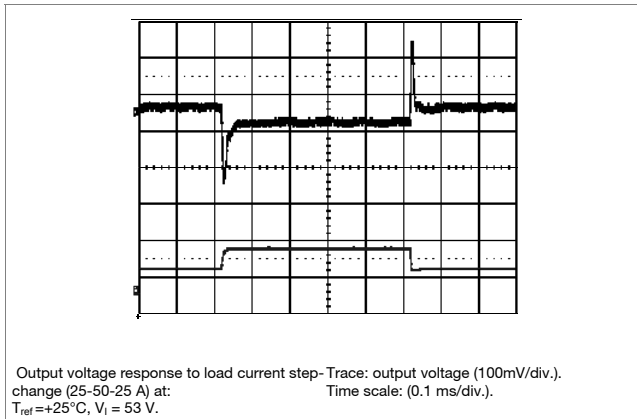

Output Voltage Adjust (see operating information)

Passive adjust

The resistor value for an adjusted output voltage is calculated by using the following equations:

Output Voltage Adjust Upwards, Increase:

$$R_{adj} = [(V_o(100+\Delta\%)/(1.225\Delta\%)-(100+2\Delta\%)/\Delta\%)]\text{ k}\Omega$$

Eg Increase 5% => $V_{out} = 1.89\text{ Vdc}$
 $1.8(100+5)/(1.225 \times 5) - (100+2 \times 5)/5 = 8.8\text{ k}\Omega$

Output Voltage Adjust Downwards, Decrease:

$$R_{adj} = (100 / \Delta\% - 2)\text{ k}\Omega$$

Eg Decrease 5% => $V_{out} = 1.71\text{ Vdc}$
 $(100/5 - 2) = 18\text{ k}\Omega$

PKL 4000 PI series DC/DC converters, Input 36-75 V, Output 100 A/300 W	EN/LZT 146 311 R2E June 2007
	© Ericsson Power Modules AB

2.5 V/60 A Electrical Specification
PKL 4119 APIT

$T_{ref} = -40$ to $+100^{\circ}\text{C}$, $V_I = 36$ to 75 V, sense pins connected to output pins unless otherwise specified under Conditions.
Typical values given at: $T_{ref} = +25^{\circ}\text{C}$, $V_I = 53$ V, max I_O , unless otherwise specified under Conditions.

Characteristics		Conditions	min	typ	max	Unit
V_I	Input voltage range		36		75	V
V_{loff}	Turn-off input voltage	Decreasing input voltage	30	32.5	35	V
V_{lon}	Turn-on input voltage	Increasing input voltage	32	34.5	36	V
C_I	Internal input capacitance			2.18		μF
P_O	Output power	Output voltage initial setting	0		150	W
SVR	Supply voltage rejection (ac)	$f = 100$ Hz sinewave, 1 Vp-p		53		dB
η	Efficiency	50 % of max I_O		89		%
		max I_O		86.5		
		50 % of max I_O , $V_I = 48$ V		90		
		max I_O , $V_I = 48$ V		87		
P_d	Power Dissipation	max I_O		24		W
P_{II}	Input idling power	$I_O = 0$ A, $V_I = 53$ V		4.6		W
P_{RC}	Input standby power	$V_I = 53$ V (turned off with RC)		0.47		W
f_s	Switching frequency	0-100 % of max I_O		200		kHz

V_{O1}	Output voltage initial setting and accuracy	$T_{ref} = +25^{\circ}\text{C}$, $V_I = 53$ V, $I_O = 60$ A	2.45	2.5	2.55	V
V_O	Output adjust range	See operating information	2.00		2.75	V
	Output voltage tolerance band	10-100% of max I_O	2.42		2.58	V
	Idling voltage	$I_O = 0$ A	2.38		2.63	V
	Line regulation	max I_O		5	15	mV
	Load regulation	$V_I = 53$ V, 0-100% of max I_O		5	15	mV
V_{tr}	Load transient voltage deviation	$V_I = 53$ V, Load step 25-50-25 % of max I_O , $di/dt = 1$ A/ μs ,		± 200		mV
t_{tr}	Load transient recovery time			100		μs
t_r	Ramp-up time (from 10-90 % of V_{O1})	10-100% of max I_O		30		ms
t_s	Start-up time (from V_I connection to 90% of V_{O1})			20	30	ms
t_f	V_{in} shutdown fall time (from V_I off to 10% of V_O)	max I_O		N/A		ms
		$I_O = 0$ A		N/A		s
t_{RC}	RC start-up time	max I_O		20	30	ms
	RC shutdown fall time (from RC off to 10% of V_O)	max I_O		N/A		ms
		$I_O = 0$ A		N/A		s
I_O	Output current		0		60	A
I_{lim}	Current limit threshold	$T_{ref} < \max T_{ref}$	61	64.5	68	A
I_{sc}	Short circuit current	$T_{ref} = 25^{\circ}\text{C}$, see Note 1		75	80	A
V_{Oac}	Output ripple & noise	See ripple & noise section, max I_O , V_{O1}		80	150	mVp-p
OVP	Over voltage protection	$T_{ref} = +25^{\circ}\text{C}$, $V_I = 53$ V, 0-100% of max I_O	3.0	3.3	3.9	V

Note 1: See Operating Information section.

PKL 4000 PI series DC/DC converters, Input 36-75 V, Output 100 A/300 W	EN/LZT 146 311 R2E June 2007 © Ericsson Power Modules AB
---	---

2.5 V/60 A Typical Characteristics

PKL 4119 APIT

Efficiency

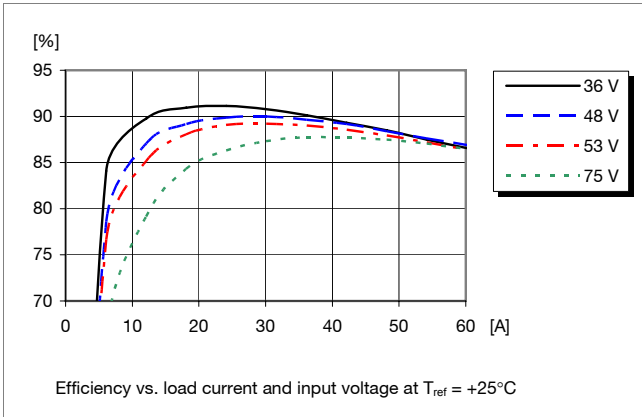

Power Dissipation

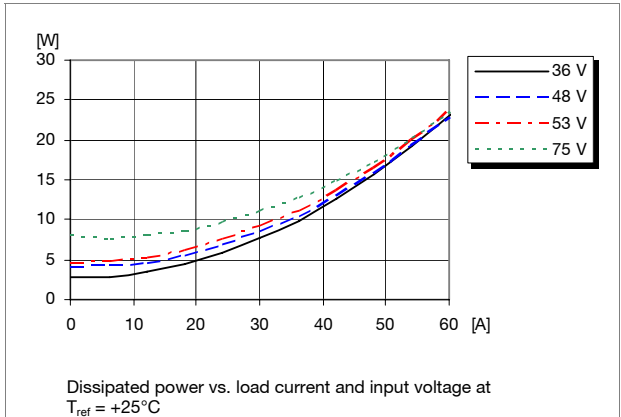

Output Current Derating

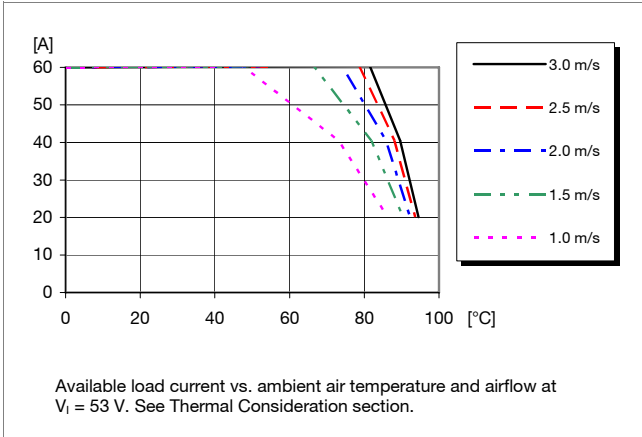

Thermal Resistance

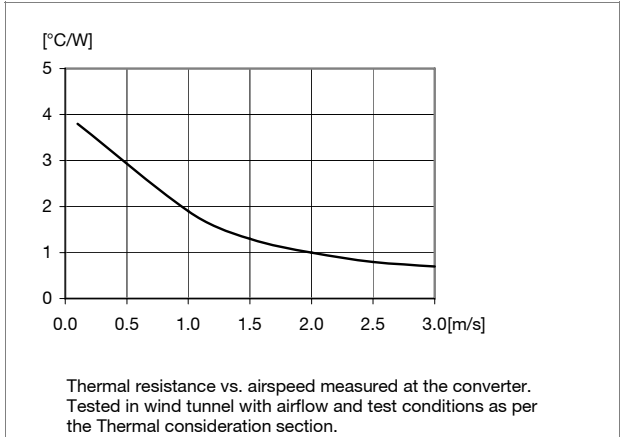

Output Characteristics

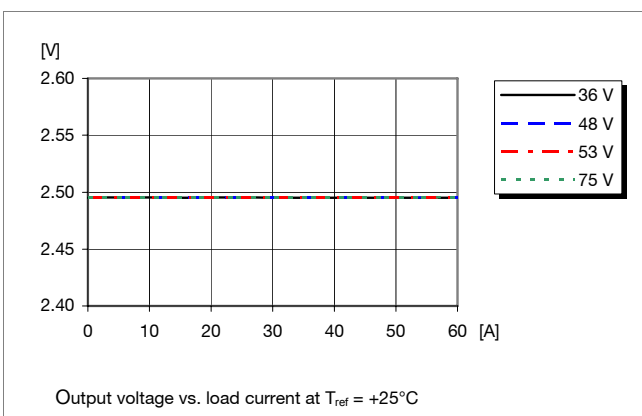

Current Limit Characteristics

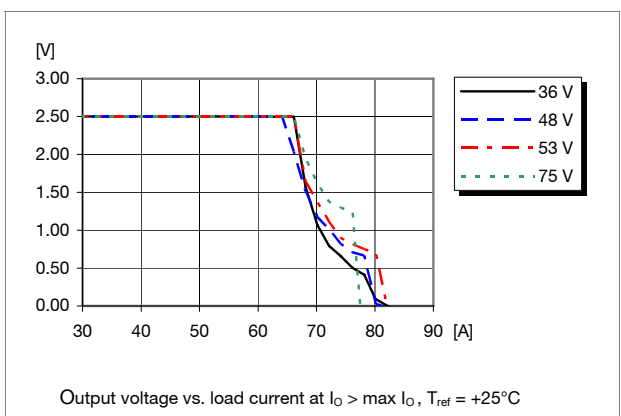

PKL 4000 PI series
DC/DC converters, Input 36-75 V, Output 100 A/300 W

EN/LZT 146 311 R2E June 2007
© Ericsson Power Modules AB

2.5 V/60 A Typical Characteristics

PKL 4119 APIT

Start-up

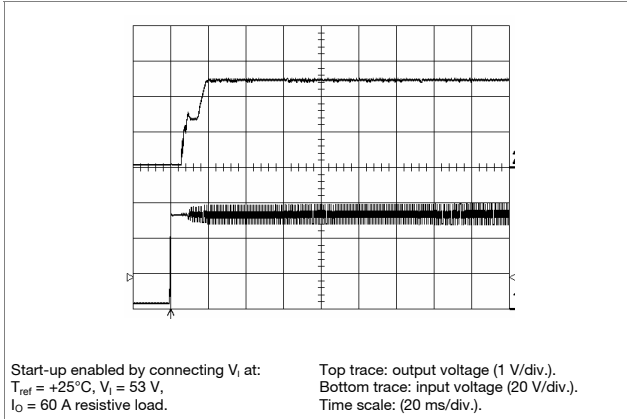

Shut-down

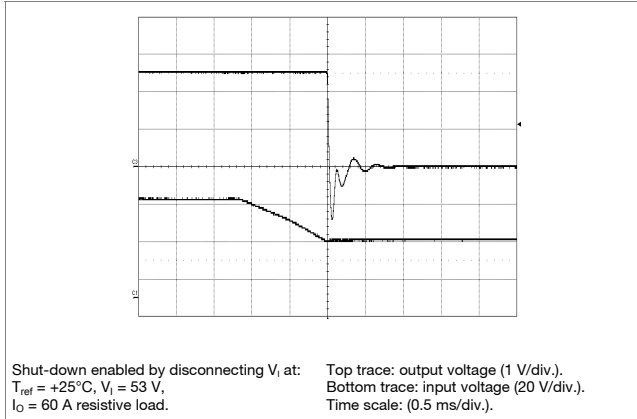

Output Ripple & Noise

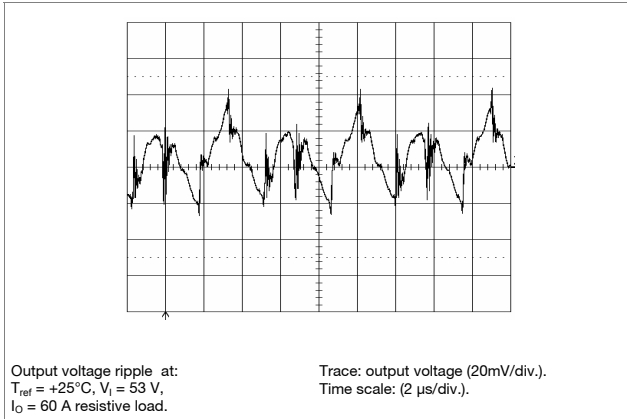

Output Load Transient Response

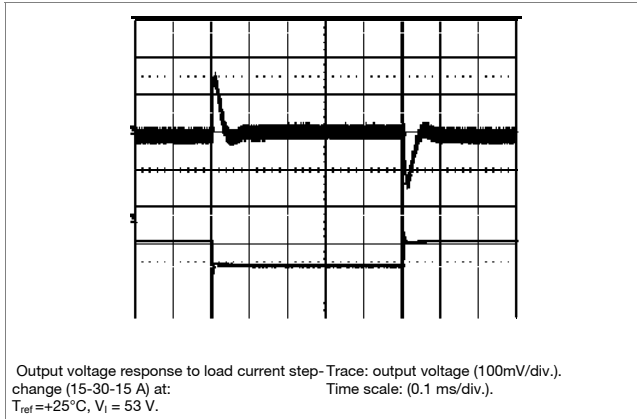

Output Voltage Adjust (see operating information)

Passive adjust

The resistor value for an adjusted output voltage is calculated by using the following equations:

Output Voltage Adjust Upwards, Increase:

$$R_{adj} = [(V_o(100+\Delta\%)/(1.225\Delta\%)-(100+2\Delta\%)/\Delta\%)] \text{ k}\Omega$$

Eg Increase 5% => $V_{out} = 2.625\text{ Vdc}$
 $2.5(100+5)/(1.225 \times 5) - (100+2 \times 5)/5 = 21 \text{ k}\Omega$

Output Voltage Adjust Downwards, Decrease:

$$R_{adj} = (100 / \Delta\% - 2) \text{ k}\Omega$$

Eg Decrease 5% => $V_{out} = 2.375\text{ Vdc}$
 $(100/5 - 2) = 18 \text{ k}\Omega$

PKL 4000 PI series DC/DC converters, Input 36-75 V, Output 100 A/300 W	EN/LZT 146 311 R2E June 2007
	© Ericsson Power Modules AB

2.5 V/80 A Electrical Specification
PKL 4219 APIT

$T_{ref} = -40$ to $+100^{\circ}\text{C}$, $V_I = 36$ to 75 V, sense pins connected to output pins unless otherwise specified under Conditions.
Typical values given at: $T_{ref} = +25^{\circ}\text{C}$, $V_I = 53$ V, max I_O , unless otherwise specified under Conditions.

Characteristics		Conditions	min	typ	max	Unit
V_I	Input voltage range		36		75	V
V_{loff}	Turn-off input voltage	Decreasing input voltage	30	32.5	35	V
V_{lon}	Turn-on input voltage	Increasing input voltage	32	34.5	36	V
C_I	Internal input capacitance			2.18		μF
P_O	Output power	Output voltage initial setting	0		200	W
SVR	Supply voltage rejection (ac)	$f = 100$ Hz sinewave, 1 Vp-p		53		dB
η	Efficiency	50 % of max I_O		88		%
		max I_O		83		
		50 % of max I_O , $V_I = 48$ V		TBD		
		max I_O , $V_I = 48$ V		TBD		
P_d	Power Dissipation	max I_O		41		W
P_{II}	Input idling power	$I_O = 0$ A, $V_I = 53$ V		5.1		W
P_{RC}	Input standby power	$V_I = 53$ V (turned off with RC)		0.34		W
f_s	Switching frequency	0-100 % of max I_O		180		kHz

V_{O1}	Output voltage initial setting and accuracy	$T_{ref} = +25^{\circ}\text{C}$, $V_I = 53$ V, $I_O = 80$ A	2.45	2.5	2.55	V
V_O	Output adjust range	See operating information	2.00		2.75	V
	Output voltage tolerance band	10-100% of max I_O	2.42		2.58	V
	Idling voltage	$I_O = 0$ A	2.38		2.63	V
	Line regulation	max I_O		5	15	mV
	Load regulation	$V_I = 53$ V, 0-100% of max I_O		5	15	mV
V_{tr}	Load transient voltage deviation	$V_I = 53$ V, Load step 25-50-25 % of max I_O , $di/dt = 1$ A/ μs ,		± 200		mV
t_{tr}	Load transient recovery time			100		μs
t_r	Ramp-up time (from 10-90 % of V_{O1})	10-100% of max I_O		TBD		ms
t_s	Start-up time (from V_I connection to 90% of V_{O1})			20	40	ms
t_f	V_{in} shutdown fall time (from V_I off to 10% of V_{O1})	max I_O		N/A		ms
		$I_O = 0$ A		N/A		s
t_{RC}	RC start-up time	max I_O		20	40	ms
		max I_O		N/A		ms
		$I_O = 0$ A		N/A		s
I_O	Output current		0		80	A
I_{lim}	Current limit threshold	$T_{ref} < \max T_{ref}$		92	97	A
I_{sc}	Short circuit current	$T_{ref} = 25^{\circ}\text{C}$, see Note 1		95	98	A
V_{Oac}	Output ripple & noise	See ripple & noise section, max I_O , V_{O1}		80	150	mVp-p
OVP	Over voltage protection	$T_{ref} = +25^{\circ}\text{C}$, $V_I = 53$ V, 0-100% of max I_O	3.0	3.3	3.9	V

Note 1: See Operating Information section.

PKL 4000 PI series DC/DC converters, Input 36-75 V, Output 100 A/300 W	EN/LZT 146 311 R2E June 2007 © Ericsson Power Modules AB
---	---

2.5 V/80 A Typical Characteristics

PKL 4219 APIT

Efficiency

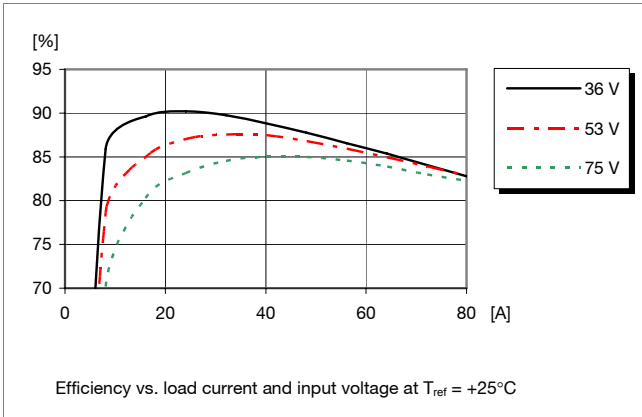

Power Dissipation

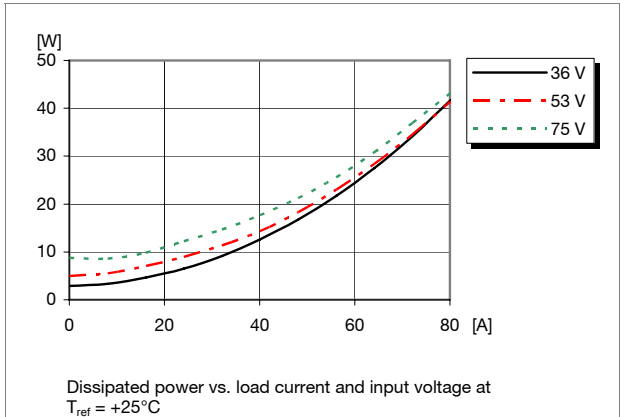

Output Current Derating

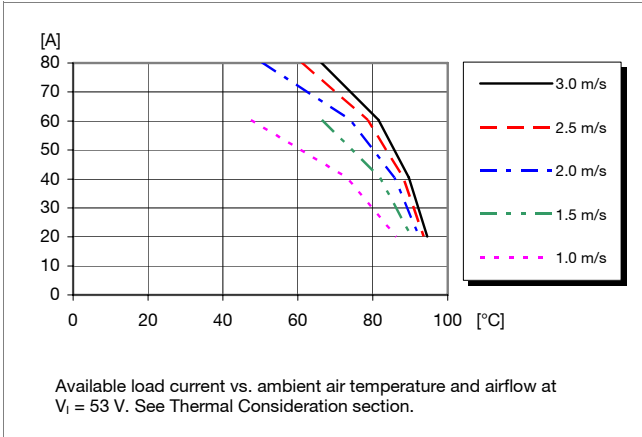

Thermal Resistance

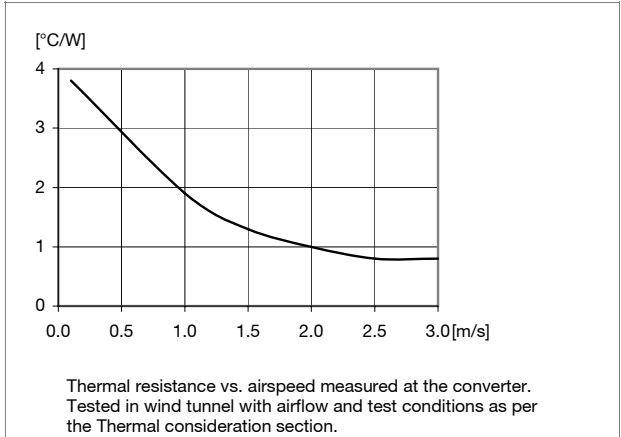

Output Characteristics

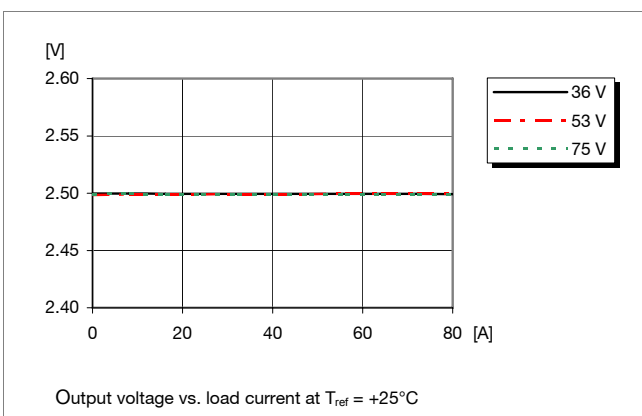

Current Limit Characteristics

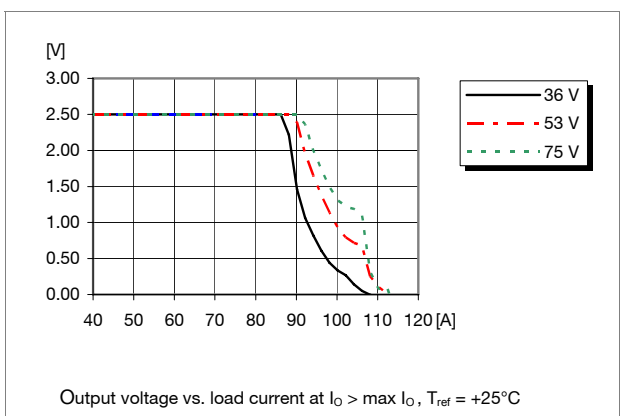

PKL 4000 PI series
DC/DC converters, Input 36-75 V, Output 100 A/300 W

EN/LZT 146 311 R2E June 2007
© Ericsson Power Modules AB

2.5 V/80 A Typical Characteristics

PKL 4219 APIT

Start-up

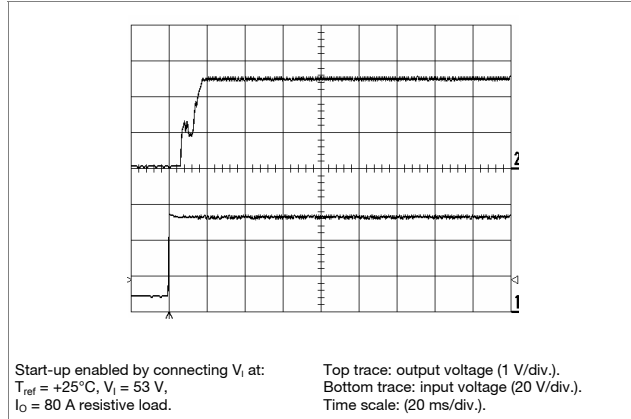

Shut-down

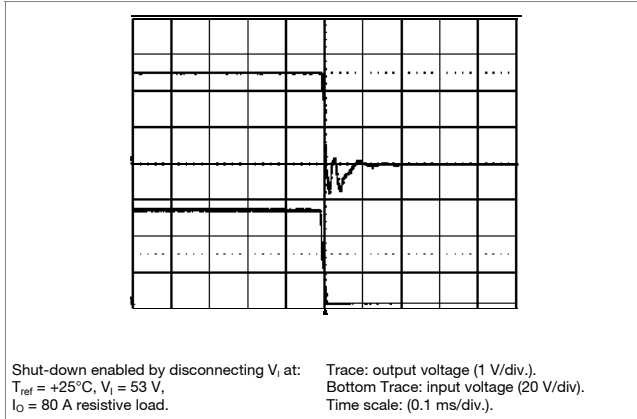

Output Ripple & Noise

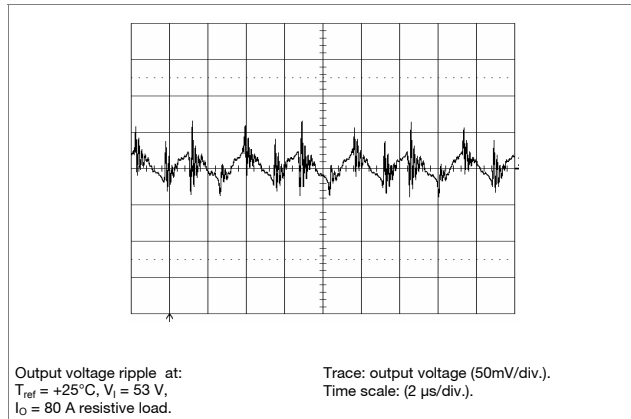

Output Load Transient Response

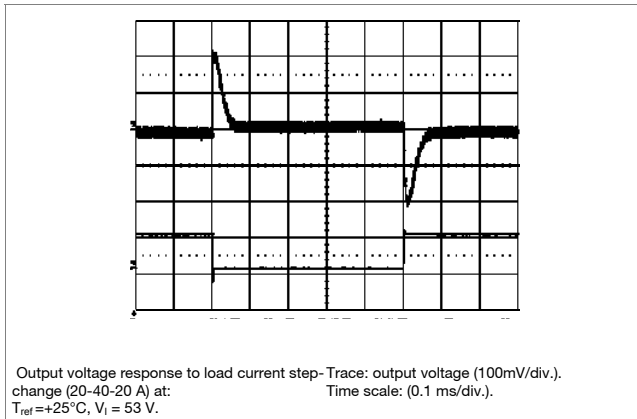

Output Voltage Adjust (see operating information)

Passive adjust

The resistor value for an adjusted output voltage is calculated by using the following equations:

Output Voltage Adjust Upwards, Increase:

$$R_{adj} = [(V_o(100+\Delta\%)/(1.225\Delta\%)-(100+2\Delta\%)/\Delta\%)]\text{ k}\Omega$$

Eg Increase 5% => $V_{out} = 2.625\text{ Vdc}$
 $2.5(100+5)/(1.225 \times 5) - (100+2 \times 5)/5 = 21\text{ k}\Omega$

Output Voltage Adjust Downwards, Decrease:

$$R_{adj} = (100 / \Delta\% - 2)\text{ k}\Omega$$

Eg Decrease 5% => $V_{out} = 2.375\text{ Vdc}$
 $(100/5 - 2) = 18\text{ k}\Omega$

PKL 4000 PI series DC/DC converters, Input 36-75 V, Output 100 A/300 W	EN/LZT 146 311 R2E June 2007
	© Ericsson Power Modules AB

3.3 V/50 A Electrical Specification
PKL 4110 PIT

$T_{ref} = -40$ to $+100^{\circ}\text{C}$, $V_i = 36$ to 75 V, sense pins connected to output pins unless otherwise specified under Conditions.
Typical values given at: $T_{ref} = +25^{\circ}\text{C}$, $V_i = 53$ V, max I_o , unless otherwise specified under Conditions.

Characteristics		Conditions	min	typ	max	Unit
V_i	Input voltage range		36		75	V
V_{loff}	Turn-off input voltage	Decreasing input voltage	30	32.5	35	V
V_{lon}	Turn-on input voltage	Increasing input voltage	32	34.5	36	V
C_i	Internal input capacitance			2.18		μF
P_o	Output power	Output voltage initial setting	0		165	W
SVR	Supply voltage rejection (ac)	$f = 100$ Hz sinewave, 1 Vp-p		53		dB
η	Efficiency	50 % of max I_o		91		%
		max I_o		89		
		50 % of max I_o , $V_i = 48$ V		91		
		max I_o , $V_i = 48$ V		89		
P_d	Power Dissipation	max I_o		21		W
P_{ii}	Input idling power	$I_o = 0$ A, $V_i = 53$ V		5.6		W
P_{RC}	Input standby power	$V_i = 53$ V (turned off with RC)		0.34		W
f_s	Switching frequency	0-100 % of max I_o		150		kHz

V_{oi}	Output voltage initial setting and accuracy	$T_{ref} = +25^{\circ}\text{C}$, $V_i = 53$ V, $I_o = 50$ A	3.25	3.3	3.35	V
V_o	Output adjust range	See operating information	2.64		3.63	V
	Output voltage tolerance band	10-100% of max I_o	3.2		3.4	V
	Idling voltage	$I_o = 0$ A	3.2		3.4	V
	Line regulation	max I_o		5	15	mV
	Load regulation	$V_i = 53$ V, 0-100% of max I_o		5	15	mV
V_{tr}	Load transient voltage deviation	$V_i = 53$ V, Load step 25-50-25 % of max I_o , $di/dt = 1$ A/ μs ,		± 200		mV
t_{tr}	Load transient recovery time			100		μs
t_r	Ramp-up time (from 10-90 % of V_{oi})	10-100% of max I_o		TBD		ms
t_s	Start-up time (from V_i connection to 90% of V_{oi})			20	30	ms
t_f	V_{in} shutdown fall time (from V_i off to 10% of V_o)	max I_o		N/A		ms
		$I_o = 0$ A		N/A		s
t_{RC}	RC start-up time	max I_o		20	30	ms
	RC shutdown fall time (from RC off to 10% of V_o)	max I_o		N/A		ms
		$I_o = 0$ A		N/A		s
I_o	Output current		0		50	A
I_{lim}	Current limit threshold	$T_{ref} < \max T_{ref}$	51	54.5	58	A
I_{sc}	Short circuit current	$T_{ref} = 25^{\circ}\text{C}$, see Note 1	63	65	67	A
V_{Oac}	Output ripple & noise	See ripple & noise section, max I_o , V_{oi}		80	150	mVp-p
OVP	Over voltage protection	$T_{ref} = +25^{\circ}\text{C}$, $V_i = 53$ V, 0-100% of max I_o	3.9	4.4	5.0	V

Note 1: See Operating Information section.

PKL 4000 PI series DC/DC converters, Input 36-75 V, Output 100 A/300 W	EN/LZT 146 311 R2E June 2007 © Ericsson Power Modules AB
---	---

3.3 V/50 A Typical Characteristics

PKL 4110 PIT

Efficiency

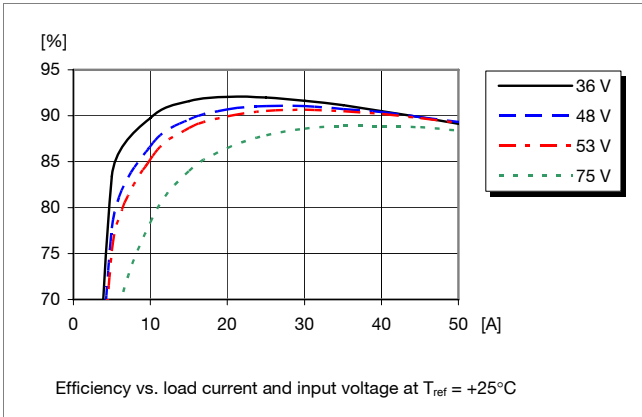

Power Dissipation

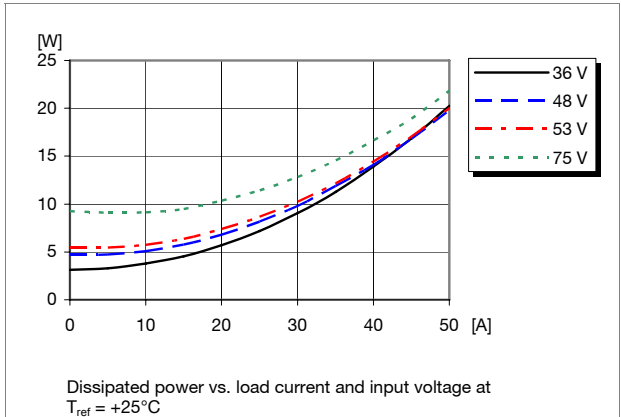

Output Current Derating

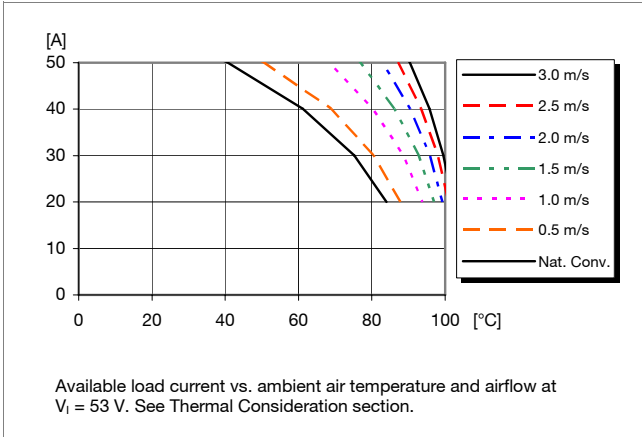

Thermal Resistance

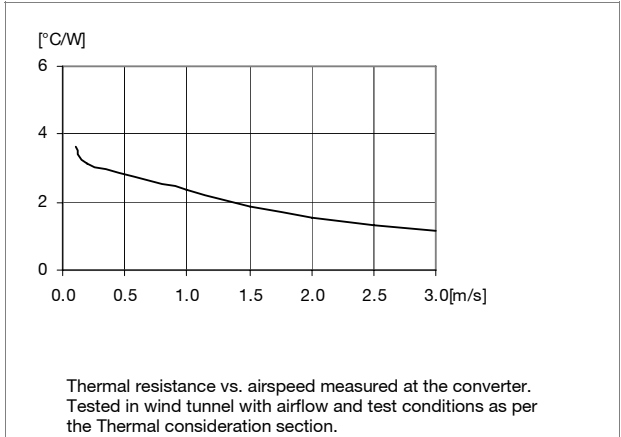

Output Characteristics

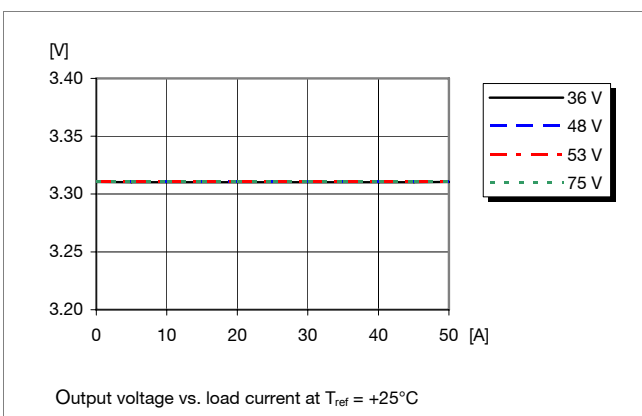

Current Limit Characteristics

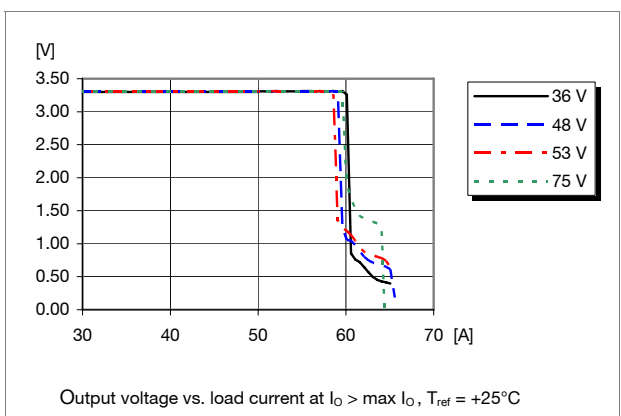

PKL 4000 PI series
DC/DC converters, Input 36-75 V, Output 100 A/300 W

EN/LZT 146 311 R2E June 2007
© Ericsson Power Modules AB

3.3 V/50 A Typical Characteristics

PKL 4110 PIT

Start-up

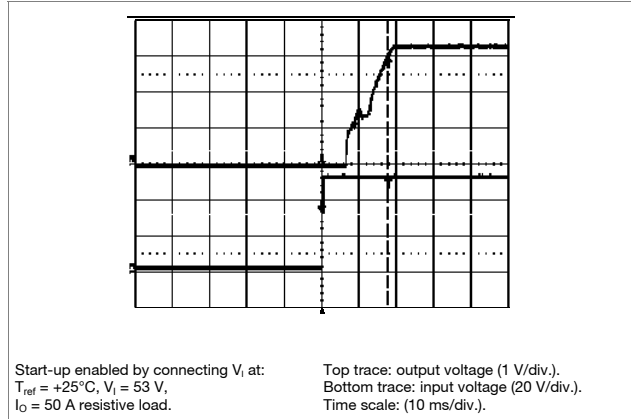

Shut-down

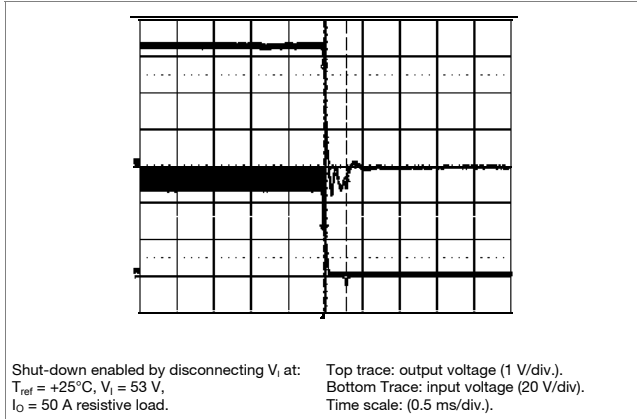

Output Ripple & Noise

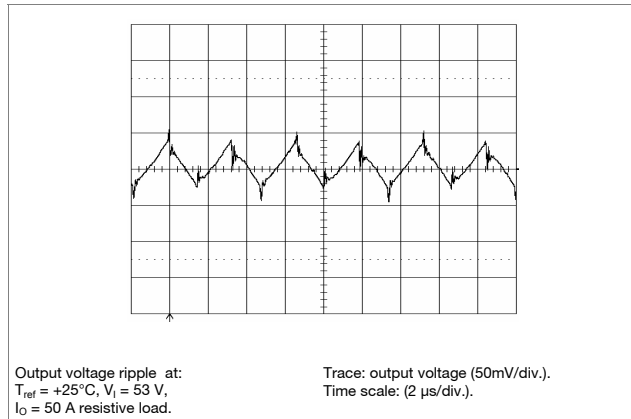

Output Load Transient Response

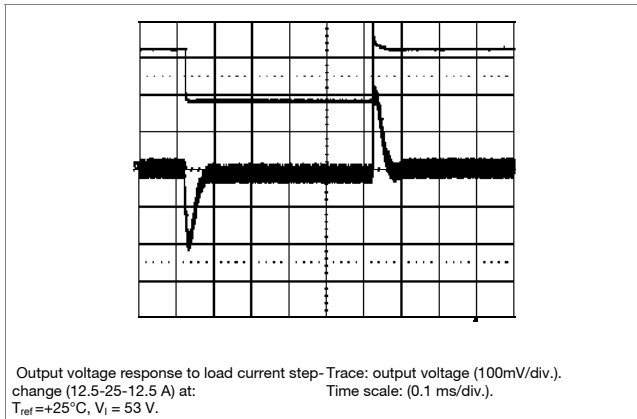

Output Voltage Adjust (see operating information)

Passive adjust

The resistor value for an adjusted output voltage is calculated by using the following equations:

Output Voltage Adjust Upwards, Increase:

$$R_{adj} = [(V_o(100+\Delta\%)/(1.225\Delta\%)-(100+2\Delta\%)/\Delta\%)] \text{ k}\Omega$$

Eg Increase 5% => $V_{out} = 3.465\text{ Vdc}$
 $3.3(100+5)/(1.225 \times 5) - (100+2 \times 5)/5 = 34.6\text{ k}\Omega$

Output Voltage Adjust Downwards, Decrease:

$$R_{adj} = (100 / \Delta\% - 2) \text{ k}\Omega$$

Eg Decrease 5% => $V_{out} = 3.135\text{ Vdc}$
 $(100/5 - 2) = 18\text{ k}\Omega$

PKL 4000 PI series DC/DC converters, Input 36-75 V, Output 100 A/300 W	EN/LZT 146 311 R2E June 2007 © Ericsson Power Modules AB
---	---

3.3 V/60 A Electrical Specification
PKL 4110 APIT

$T_{ref} = -40$ to $+100^{\circ}\text{C}$, $V_I = 36$ to 75 V, sense pins connected to output pins unless otherwise specified under Conditions.
 Typical values given at: $T_{ref} = +25^{\circ}\text{C}$, $V_I = 53$ V, max I_O , unless otherwise specified under Conditions.

Characteristics	Conditions	min	typ	max	Unit
V_I	Input voltage range	36		75	V
V_{loff}	Turn-off input voltage	Decreasing input voltage		35	V
V_{lon}	Turn-on input voltage	Increasing input voltage		36	V
C_I	Internal input capacitance		2.18		μF
P_O	Output power	Output voltage initial setting		200	W
SVR	Supply voltage rejection (ac)	$f = 100$ Hz sinewave, 1 Vp-p		53	dB
η	Efficiency	50 % of max I_O		92	%
		max I_O		91	
		50 % of max I_O , $V_I = 48$ V		92	
		max I_O , $V_I = 48$ V		91	
P_d	Power Dissipation	max I_O		21	W
P_{II}	Input idling power	$I_O = 0$ A, $V_I = 53$ V		5.7	W
P_{RC}	Input standby power	$V_I = 53$ V (turned off with RC)		0.28	W
f_s	Switching frequency	0-100 % of max I_O		150	kHz

V_{O1}	Output voltage initial setting and accuracy	$T_{ref} = +25^{\circ}\text{C}$, $V_I = 53$ V, $I_O = 60$ A	3.25	3.3	3.35	V
V_O	Output adjust range	See operating information	2.64		3.63	V
	Output voltage tolerance band	10-100% of max I_O	3.2		3.4	V
	Idling voltage	$I_O = 0$ A	3.2		3.4	V
	Line regulation	max I_O		5	15	mV
	Load regulation	$V_I = 53$ V, 0-100% of max I_O		5	15	mV
V_{tr}	Load transient voltage deviation	$V_I = 53$ V, Load step 25-50-25 % of max I_O , $di/dt = 1$ A/ μs ,		± 250		mV
t_{tr}	Load transient recovery time			200		μs
t_r	Ramp-up time (from 10-90 % of V_{O1})	10-100% of max I_O		TBD		ms
t_s	Start-up time (from V_I connection to 90% of V_{O1})			20	30	ms
t_f	Vin shutdown fall time (from V_I off to 10% of V_O)	max I_O		N/A		ms
		$I_O = 0$ A		N/A		s
t_{RC}	RC start-up time	max I_O		20	30	ms
	RC shutdown fall time (from RC off to 10% of V_O)	max I_O		N/A		ms
		$I_O = 0$ A		N/A		s
I_O	Output current		0		60	A
I_{lim}	Current limit threshold	$T_{ref} < \max T_{ref}$	61	64.8	72	A
I_{sc}	Short circuit current	$T_{ref} = 25^{\circ}\text{C}$, see Note 1		76		A
V_{Oac}	Output ripple & noise	See ripple & noise section, max I_O , V_{O1}		80	150	mVp-p
OVP	Over voltage protection	$T_{ref} = +25^{\circ}\text{C}$, $V_I = 53$ V, 0-100% of max I_O	3.9	4.4	5.0	V

Note 1: See Operating Information section.

PKL 4000 PI series DC/DC converters, Input 36-75 V, Output 100 A/300 W	EN/LZT 146 311 R2E June 2007 © Ericsson Power Modules AB
---	---

3.3 V/60 A Typical Characteristics

PKL 4110 APIT

Efficiency

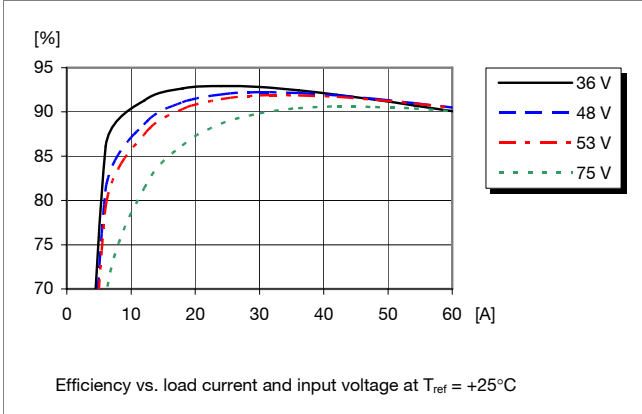

Power Dissipation

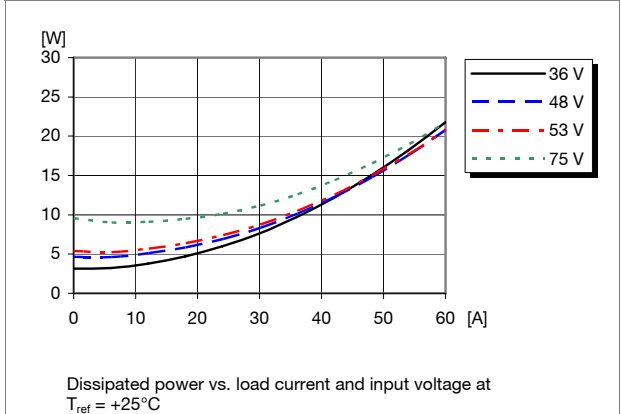

Output Current Derating

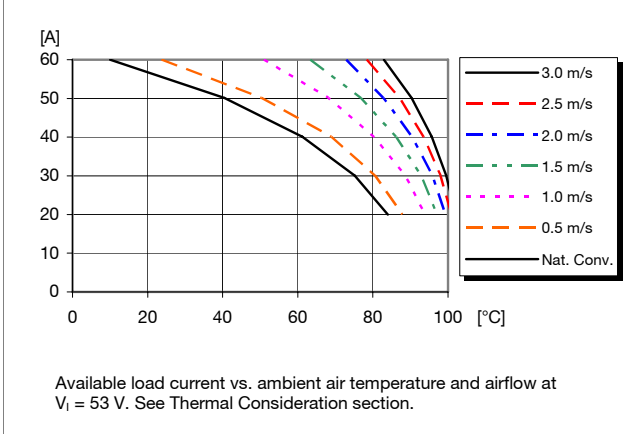

Thermal Resistance

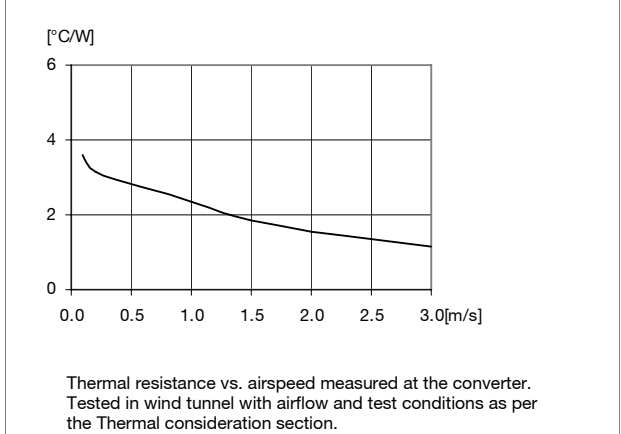

Output Characteristics

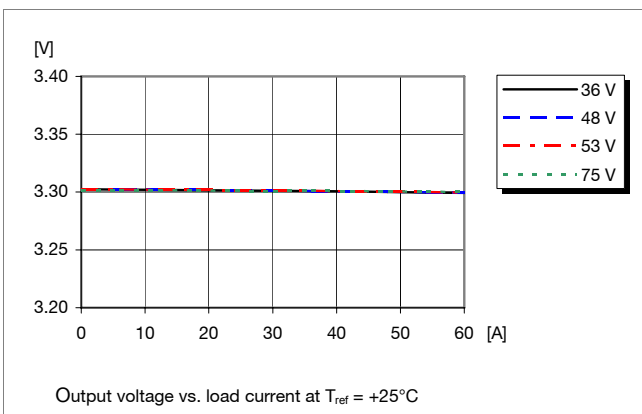

Current Limit Characteristics

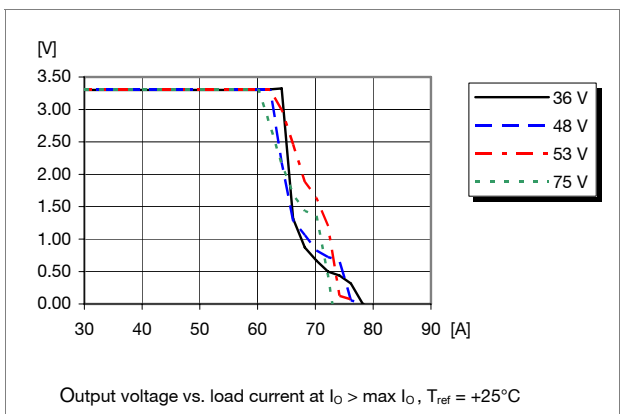

PKL 4000 PI series
DC/DC converters, Input 36-75 V, Output 100 A/300 W

EN/LZT 146 311 R2E June 2007
© Ericsson Power Modules AB

3.3 V/60 A Typical Characteristics

PKL 4110 APIT

Start-up

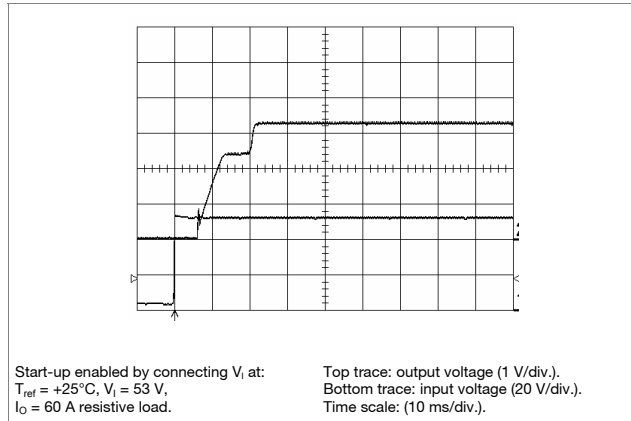

Shut-down

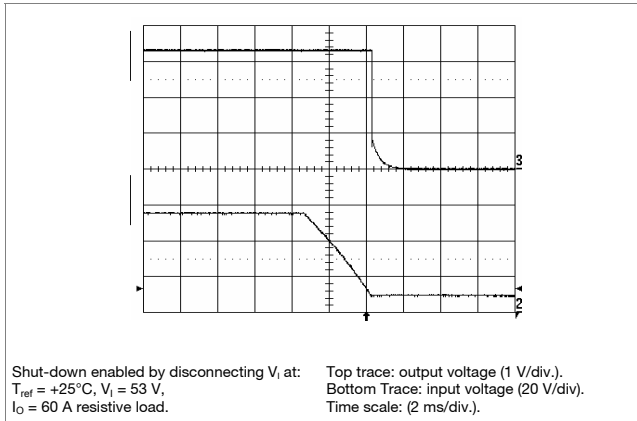

Output Ripple & Noise

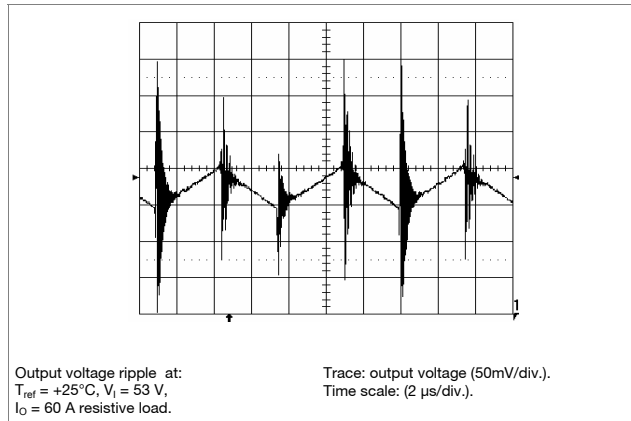

Output Load Transient Response

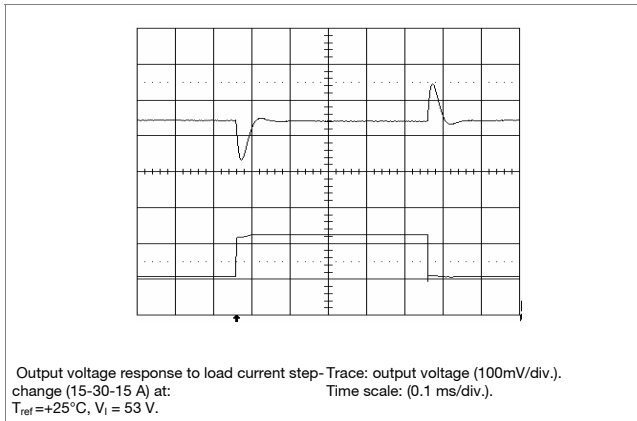

Output Voltage Adjust (see operating information)

Passive adjust

The resistor value for an adjusted output voltage is calculated by using the following equations:

Output Voltage Adjust Upwards, Increase:

$$R_{adj} = [(V_o(100+\Delta\%)/(1.225\Delta\%)-(100+2\Delta\%)/\Delta\%)] \text{ k}\Omega$$

Eg Increase 5% => $V_{out} = 3.465\text{ Vdc}$
 $3.3(100+5)/(1.225 \times 5) - (100+2 \times 5)/5 = 34.6\text{ k}\Omega$

Output Voltage Adjust Downwards, Decrease:

$$R_{adj} = (100 / \Delta\% - 2) \text{ k}\Omega$$

Eg Decrease 5% => $V_{out} = 3.135\text{ Vdc}$
 $(100/5 - 2) = 18\text{ k}\Omega$

PKL 4000 PI series DC/DC converters, Input 36-75 V, Output 100 A/300 W	EN/LZT 146 311 R2E June 2007
	© Ericsson Power Modules AB

5 V/60 A Electrical Specification
PKL 4311 PIT

$T_{ref} = -40$ to $+100^{\circ}\text{C}$, $V_i = 36$ to 75 V, sense pins connected to output pins unless otherwise specified under Conditions.
Typical values given at: $T_{ref} = +25^{\circ}\text{C}$, $V_i = 53$ V, $\max I_o$, unless otherwise specified under Conditions.

Characteristics		Conditions	min	typ	max	Unit
V_i	Input voltage range		36		75	V
V_{loff}	Turn-off input voltage	Decreasing input voltage	30	32.5	35	V
V_{lon}	Turn-on input voltage	Increasing input voltage	32	34.5	36	V
C_i	Internal input capacitance			2.18		μF
P_o	Output power	Output voltage initial setting	0		300	W
SVR	Supply voltage rejection (ac)	$f = 100$ Hz sinewave, 1 Vp-p		53		dB
η	Efficiency	50 % of $\max I_o$		88		%
		$\max I_o$		87		
		50 % of $\max I_o$, $V_i = 48$ V		TBD		
		$\max I_o$, $V_i = 48$ V		TBD		
P_d	Power Dissipation	$\max I_o$		45		W
P_{ii}	Input idling power	$I_o = 0$ A, $V_i = 53$ V		5.5		W
P_{RC}	Input standby power	$V_i = 53$ V (turned off with RC)		0.28		W
f_s	Switching frequency	0-100 % of $\max I_o$		200		kHz

V_{oi}	Output voltage initial setting and accuracy	$T_{ref} = +25^{\circ}\text{C}$, $V_i = 53$ V, $I_o = 60$ A	4.9	5.0	5.1	V
V_o	Output adjust range	See operating information	4.0		5.5	V
	Output voltage tolerance band	10-100% of $\max I_o$	4.85		5.15	V
	Idling voltage	$I_o = 0$ A	4.85		5.15	V
	Line regulation	$\max I_o$		5	15	mV
	Load regulation	$V_i = 53$ V, 0-100% of $\max I_o$		5	15	mV
V_{tr}	Load transient voltage deviation	$V_i = 53$ V, Load step 25-50-25 % of $\max I_o$, $di/dt = 1$ A/ μs ,		± 250		mV
t_{tr}	Load transient recovery time			150		μs
t_r	Ramp-up time (from 10-90 % of V_{oi})	10-100% of $\max I_o$		TBD		ms
t_s	Start-up time (from V_i connection to 90% of V_{oi})			15		ms
t_f	V_{in} shutdown fall time (from V_i off to 10% of V_o)	$\max I_o$		N/A		ms
		$I_o = 0$ A		N/A		s
t_{RC}	RC start-up time	$\max I_o$		20		ms
	RC shutdown fall time (from RC off to 10% of V_o)	$\max I_o$		N/A		ms
		$I_o = 0$ A		N/A		s
I_o	Output current		0		60	A
I_{lim}	Current limit threshold	$T_{ref} < \max T_{ref}$		66.5		A
I_{sc}	Short circuit current	$T_{ref} = 25^{\circ}\text{C}$, see Note 1		80		A
V_{Oac}	Output ripple & noise	See ripple & noise section, $\max I_o$, V_{oi}		100	150	mVp-p
OVP	Over voltage protection	$T_{ref} = +25^{\circ}\text{C}$, $V_i = 53$ V, 0-100% of $\max I_o$		5.9		V

Note 1: See Operating Information section.

PKL 4000 PI series
DC/DC converters, Input 36-75 V, Output 100 A/300 W

EN/LZT 146 311 R2E June 2007
© Ericsson Power Modules AB

5 V/60 A Typical Characteristics

PKL 4311 PIT

Efficiency

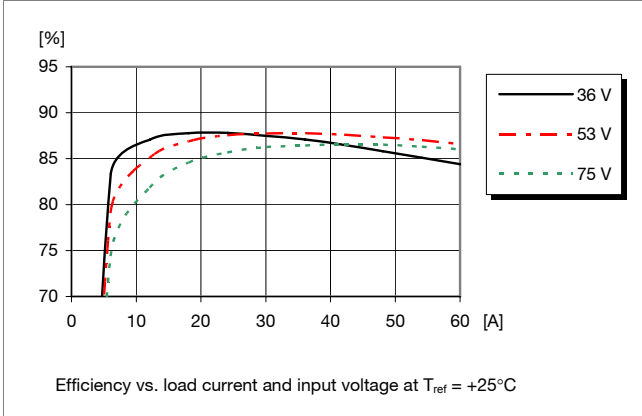

Power Dissipation

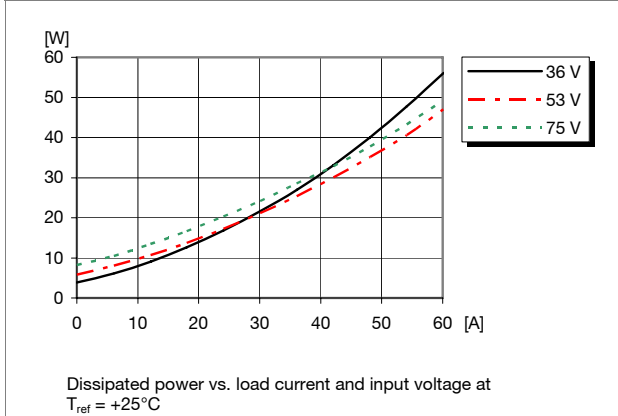

Output Current Derating

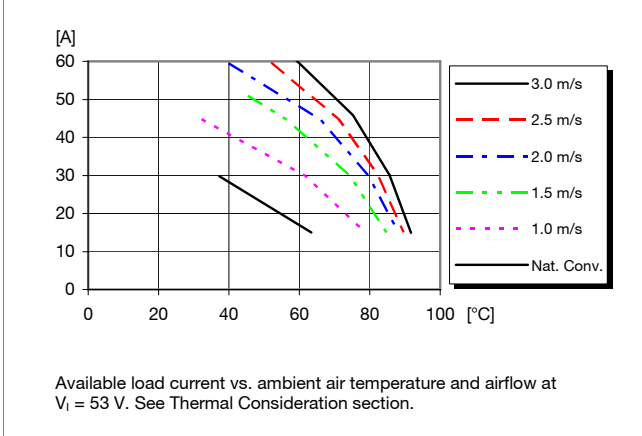

Thermal Resistance

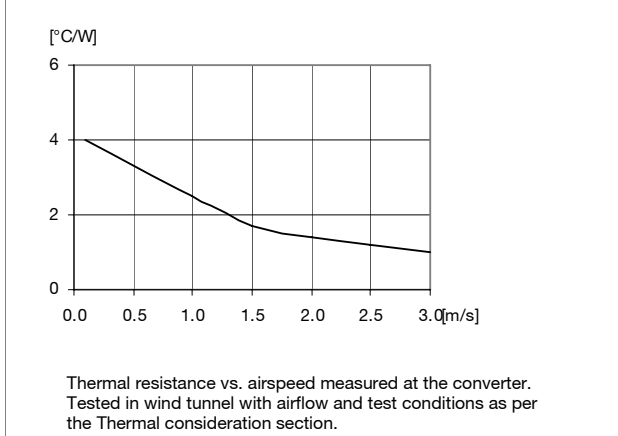

Output Characteristics

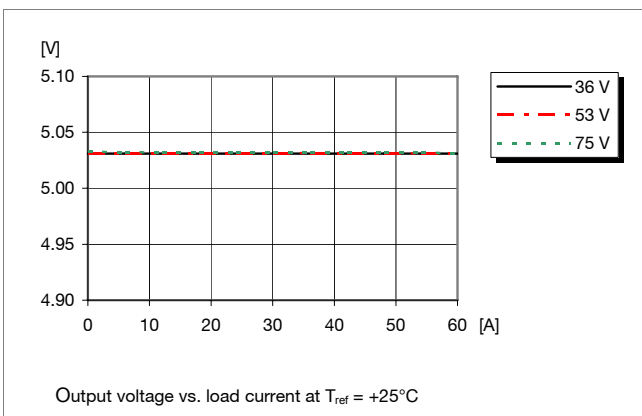

Current Limit Characteristics

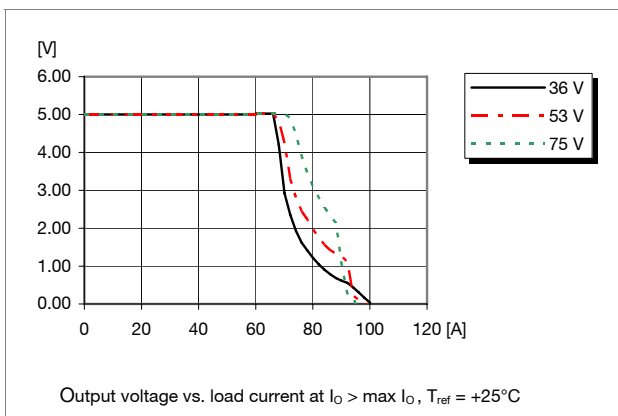

PKL 4000 PI series
DC/DC converters, Input 36-75 V, Output 100 A/300 W

EN/LZT 146 311 R2E June 2007
© Ericsson Power Modules AB

5 V/60 A Typical Characteristics

PKL 4311 PIT

Start-up

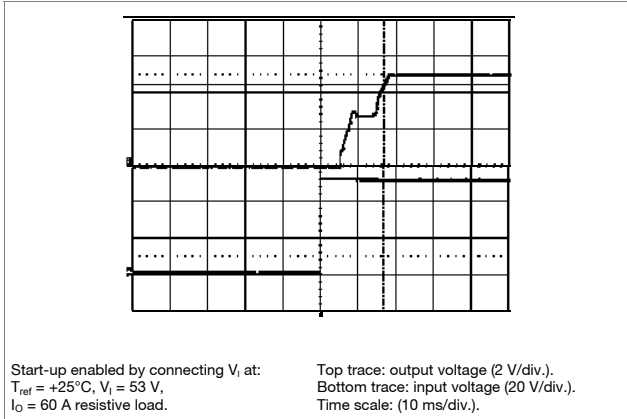

Shut-down

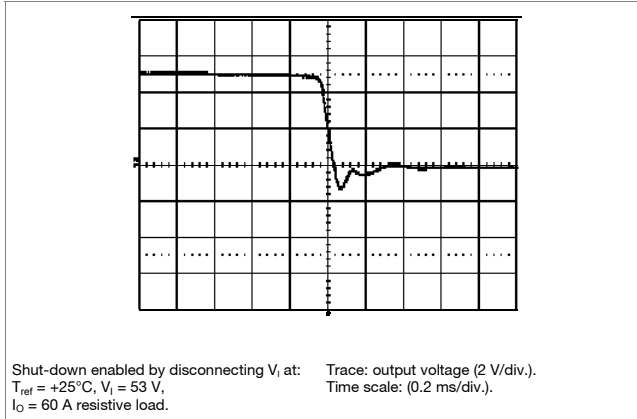

Output Ripple & Noise

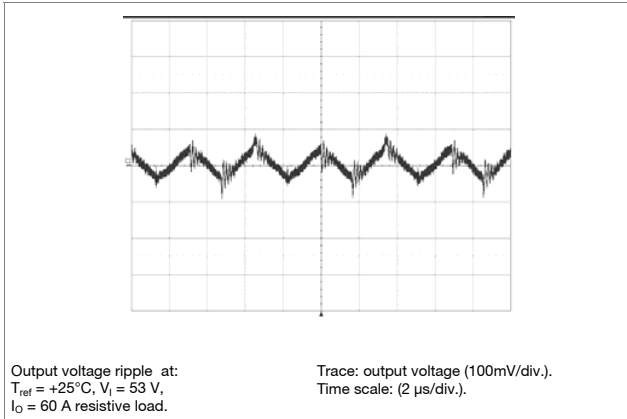

Output Load Transient Response

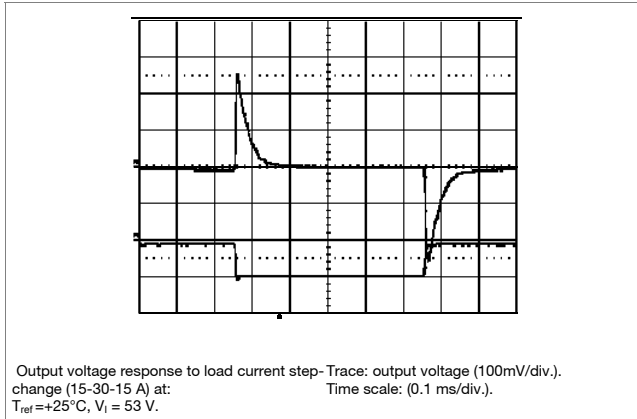

Output Voltage Adjust (see operating information)

Passive adjust

The resistor value for an adjusted output voltage is calculated by using the following equations:

Output Voltage Adjust Upwards, Increase:

$$R_{adj} = [(V_o(100+\Delta\%)/(1.225\Delta\%)-(100+2\Delta\%)/\Delta\%)] \text{ k}\Omega$$

Eg Increase 5% => $V_{out} = 5.25\text{ Vdc}$
 $5(100+5)/(1.225 \times 5) - (100+2 \times 5)/5 = 64\text{ k}\Omega$

Output Voltage Adjust Downwards, Decrease:

$$R_{adj} = (100 / \Delta\% - 2) \text{ k}\Omega$$

Eg Decrease 5% => $V_{out} = 4.75\text{ Vdc}$
 $(100/5-2) = 18\text{ k}\Omega$

PKL 4000 PI series DC/DC converters, Input 36-75 V, Output 100 A/300 W	EN/LZT 146 311 R2E June 2007
	© Ericsson Power Modules AB

12 V/25 A Electrical Specification
PKL 4313 PIT

$T_{ref} = -40$ to $+100^{\circ}\text{C}$, $V_i = 36$ to 75 V, sense pins connected to output pins unless otherwise specified under Conditions.
Typical values given at: $T_{ref} = +25^{\circ}\text{C}$, $V_i = 53$ V, max I_o , unless otherwise specified under Conditions.

Characteristics		Conditions	min	typ	max	Unit
V_i	Input voltage range		36		75	V
V_{loff}	Turn-off input voltage	Decreasing input voltage	30	32.5	35	V
V_{lon}	Turn-on input voltage	Increasing input voltage	32	34.5	36	V
C_i	Internal input capacitance			2.18		μF
P_o	Output power	Output voltage initial setting	0		300	W
SVR	Supply voltage rejection (ac)	$f = 100$ Hz sinewave, 1 Vp-p		53		dB
η	Efficiency	50 % of max I_o		92		%
		max I_o		92		
		50 % of max I_o , $V_i = 48$ V		92		
		max I_o , $V_i = 48$ V		92		
P_d	Power Dissipation	max I_o		28		W
P_{ii}	Input idling power	$I_o = 0$ A, $V_i = 53$ V		6.7		W
P_{RC}	Input standby power	$V_i = 53$ V (turned off with RC)		0.39		W
f_s	Switching frequency	0-100 % of max I_o		200		kHz

V_{oi}	Output voltage initial setting and accuracy	$T_{ref} = +25^{\circ}\text{C}$, $V_i = 53$ V, $I_o = 25$ A	11.8	12	12.2	V
V_o	Output adjust range	See operating information	9.6		13.2	V
	Output voltage tolerance band	10-100% of max I_o	11.64		12.36	V
	Idling voltage	$I_o = 0$ A	11.64		12.36	V
	Line regulation	max I_o		12	20	mV
	Load regulation	$V_i = 53$ V, 0-100% of max I_o		12	20	mV
V_{tr}	Load transient voltage deviation	$V_i = 53$ V, Load step 25-50-25 % of max I_o , $di/dt = 1$ A/ μs ,		± 200		mV
t_{tr}	Load transient recovery time			200		μs
t_r	Ramp-up time (from 10-90 % of V_{oi})	10-100% of max I_o		15		ms
t_s	Start-up time (from V_i connection to 90% of V_{oi})			20	30	ms
t_f	V_{in} shutdown fall time (from V_i off to 10% of V_o)	max I_o		N/A		ms
		$I_o = 0$ A		N/A		s
t_{RC}	RC start-up time	max I_o		20	30	ms
	RC shutdown fall time (from RC off to 10% of V_o)	max I_o		N/A		ms
		$I_o = 0$ A		N/A		s
I_o	Output current		0		25	A
I_{lim}	Current limit threshold	$T_{ref} < \max T_{ref}$		27.5	32	A
I_{sc}	Short circuit current	$T_{ref} = 25^{\circ}\text{C}$, see Note 1		30	42	A
V_{Oac}	Output ripple & noise	See ripple & noise section, max I_o , V_{oi}		80	150	mVp-p
OVP	Over voltage protection	$T_{ref} = +25^{\circ}\text{C}$, $V_i = 53$ V, 0-100% of max I_o		14.9		V

Note 1: See Operating Information section.

PKL 4000 PI series DC/DC converters, Input 36-75 V, Output 100 A/300 W	EN/LZT 146 311 R2E June 2007 © Ericsson Power Modules AB
---	---

12 V/25 A Typical Characteristics

PKL 4313 PIT

Efficiency

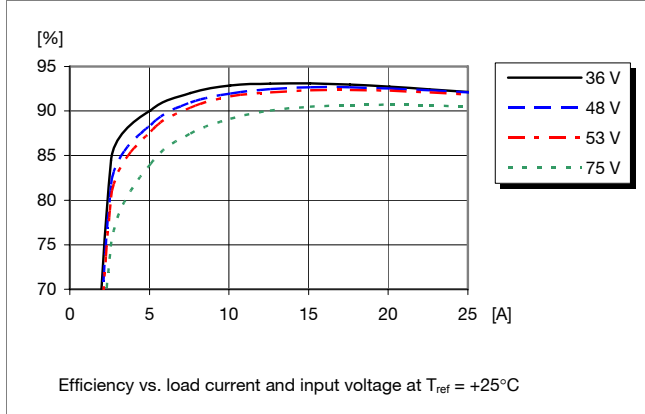

Power Dissipation

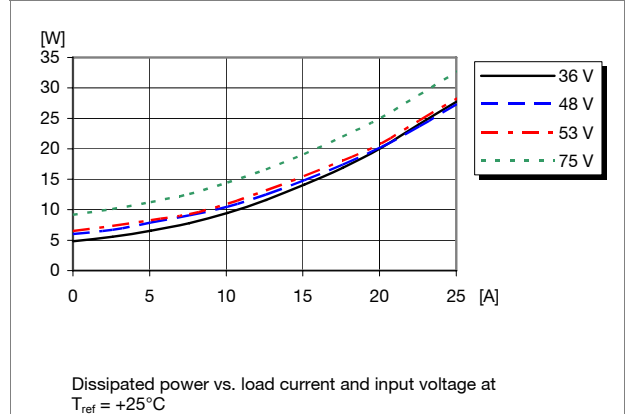

Output Current Derating

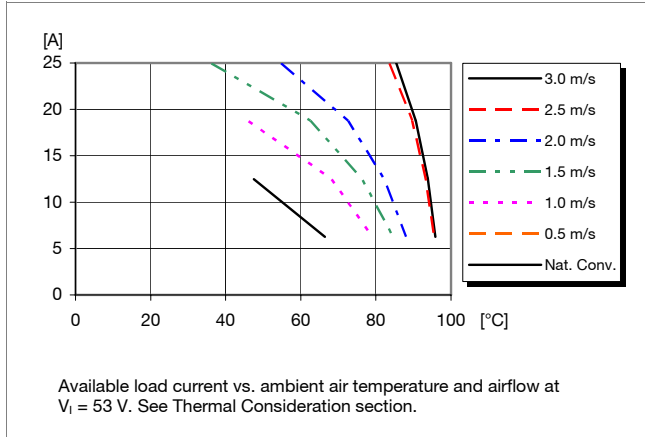

Thermal Resistance

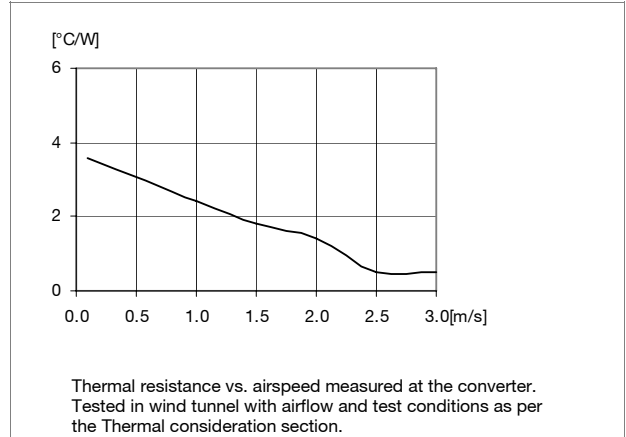

Output Characteristics

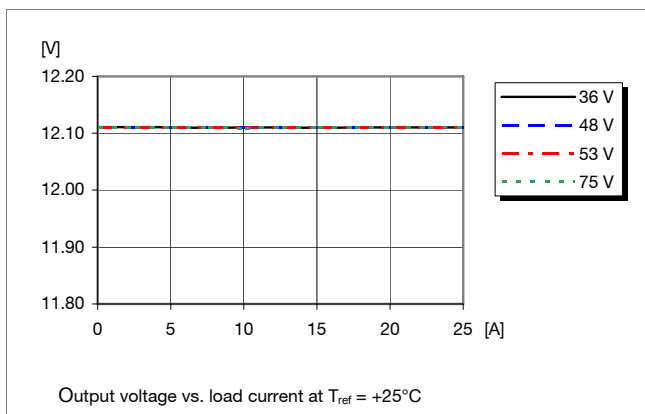

Current Limit Characteristics

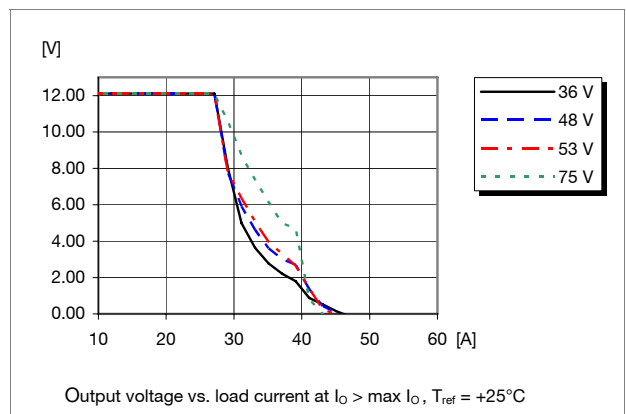

PKL 4000 PI series
DC/DC converters, Input 36-75 V, Output 100 A/300 W

EN/LZT 146 311 R2E June 2007
© Ericsson Power Modules AB

12 V/25 A Typical Characteristics

PKL 4313 PIT

Start-up

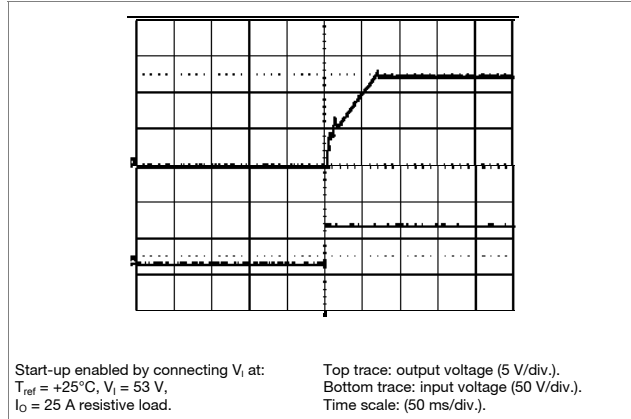

Shut-down

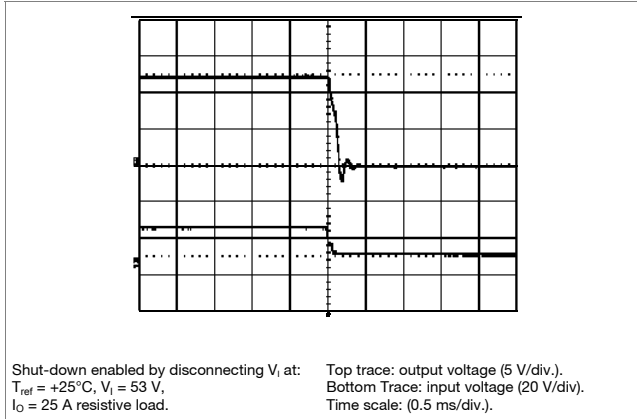

Output Ripple & Noise

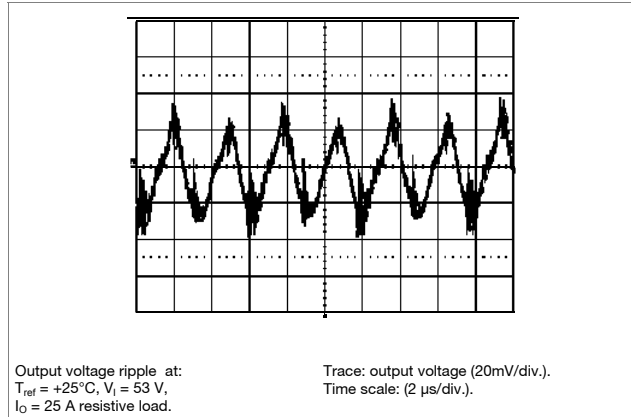

Output Load Transient Response

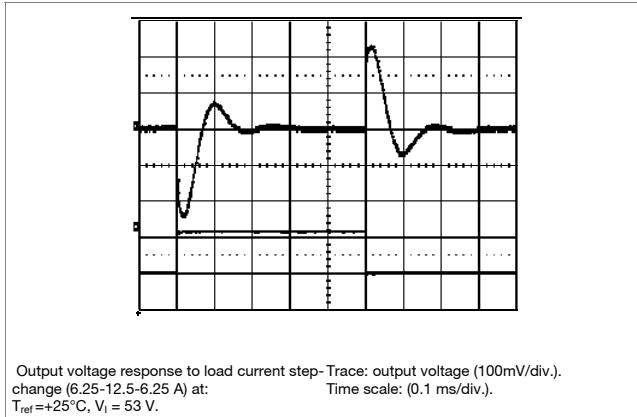

Output Voltage Adjust (see operating information)

Passive adjust

The resistor value for an adjusted output voltage is calculated by using the following equations:

Output Voltage Adjust Upwards, Increase:

$$R_{adj} = [(V_o(100+\Delta\%)/(1.225\Delta\%)-(100+2\Delta\%)/\Delta\%)] \text{ k}\Omega$$

Eg Increase 2% => $V_{out} = 12.24\text{ Vdc}$
 $12(100+2)/(1.225 \times 2) - (100+2 \times 2)/2 = 447\text{ k}\Omega$

Output Voltage Adjust Downwards, Decrease:

$$R_{adj} = (100 / \Delta\% - 2) \text{ k}\Omega$$

Eg Decrease 2% => $V_{out} = 11.76\text{ Vdc}$
 $(100/2-2) = 48\text{ k}\Omega$

PKL 4000 PI series DC/DC converters, Input 36-75 V, Output 100 A/300 W	EN/LZT 146 311 R2E June 2007 © Ericsson Power Modules AB
---	---

EMC Specification

Conducted EMI measured according to EN55022, CISPR 22 and FCC part 15J (see test set-up). See Design Note 009 for further information. The fundamental switching frequency is 150 kHz for PKL 4118A PIT @ $V_i = 53 V$, max I_o .

Conducted EMI Input terminal value (typ)

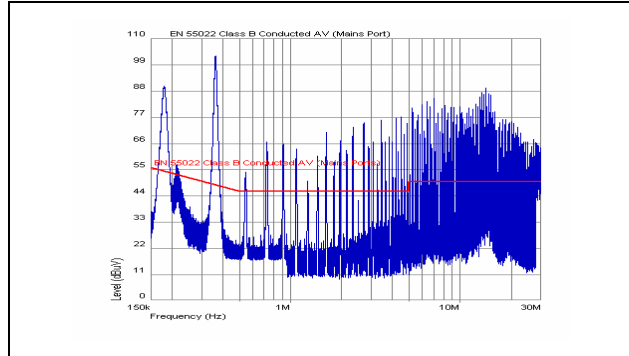

EMI without filter

External filter (class B)

Required external input filter in order to meet class B in EN 55022, CISPR 22 and FCC part 15J.

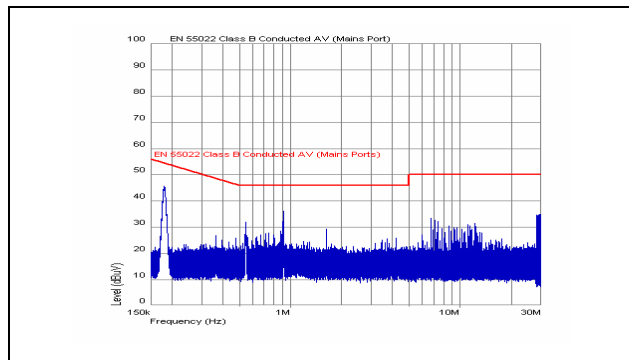
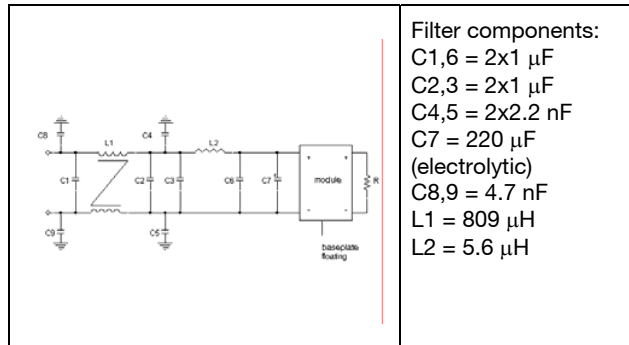

EMI with filter

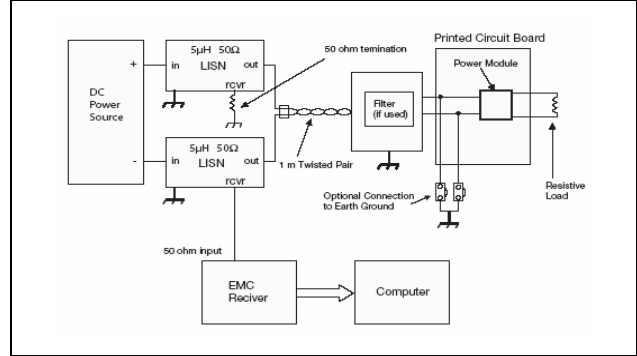

Test set-up

Layout recommendation

The radiated EMI performance of the DC/DC converter will depend on the PCB layout and ground layer design. It is also important to consider the stand-off of the DC/DC converter.

If a ground layer is used, it should be connected to the output of the DC/DC converter and the equipment ground or chassis.

A ground layer will increase the stray capacitance in the PCB and improve the high frequency EMC performance.

Output ripple and noise

Output ripple and noise measured according to figure below. See Design Note 022 for detailed information.

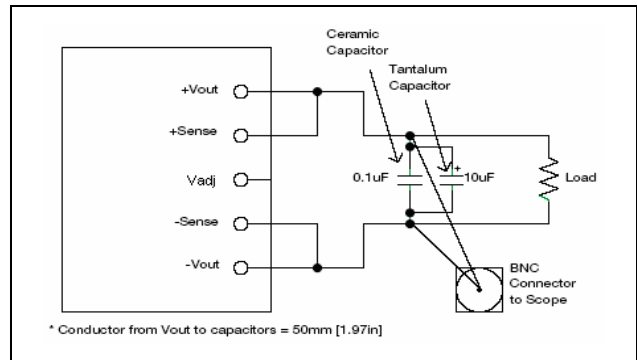

Output ripple and noise test setup

PKL 4000 PI series	EN/LZT 146 311 R2E June 2007
DC/DC converters, Input 36-75 V, Output 100 A/300 W	© Ericsson Power Modules AB

Operating information

Input Voltage

The input voltage range 36 to 75Vdc meets the requirements of the European Telecom Standard ETS 300 132-2 for normal input voltage range in -48 and -60 Vdc systems, -40.5 to -57.0 V and -50.0 to -72 V respectively. At input voltages exceeding 75 V, the power loss will be higher than at normal input voltage and T_{ref} must be limited to absolute max +100°C. The absolute maximum continuous input voltage is 80 Vdc.

Turn-off Input Voltage

The DC/DC converters monitor the input voltage and will turn on and turn off at predetermined levels. The minimum hysteresis between turn on and turn off input voltage is 1V.

Remote Control (RC)

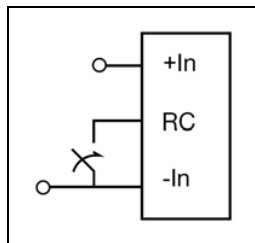

The products are fitted with a remote control function referenced to the primary negative input connection (- In), with negative and positive logic options available. The RC function allows the converter to be turned on/off by an external device like a semiconductor or mechanical switch.

The maximum required sink current is 1 mA. When the RC pin is left open, the voltage generated on the RC pin is 3.0 – 6.5 V. The second option is “positive logic” remote control, which can be ordered by adding the suffix “P” to the end of the part number. The converter will turn on when the input voltage is applied with the RC pin open. Turn off is achieved by connecting the RC pin to the - In. To ensure safe turn off the voltage difference between RC pin and the - In pin shall be less than 1V. The converter will restart automatically when this connection is opened.

See Design Note 021 for detailed information.

Input and Output Impedance

The impedance of both the input source and the load will interact with the impedance of the DC/DC converter. It is important that the input source has low characteristic impedance. The converters are designed for stable operation without external capacitors connected to the input or output. The performance in some applications can be enhanced by addition of external capacitance as described under External Decoupling Capacitors. If the input voltage source contains significant inductance, the addition of a 100 µF capacitor across the input of the converter will ensure stable operation. The capacitor is not required when powering the DC/DC converter from an input source with an inductance below 10 µH.

External Decoupling Capacitors

When powering loads with significant dynamic current requirements, the voltage regulation at the point of load can be improved by addition of decoupling capacitors at the load. The most effective technique is to locate low ESR ceramic and electrolytic capacitors as close to the load as possible, using several parallel capacitors to lower the effective ESR. The ceramic capacitors will handle high-frequency dynamic load changes while the electrolytic capacitors are used to handle low frequency dynamic load changes. Ceramic capacitors will also reduce any high frequency noise at the load.

It is equally important to use low resistance and low inductance PCB layouts and cabling.

External decoupling capacitors will become part of the control loop of the DC/DC converter and may affect the stability margins. As a “rule of thumb”, 100 µF/A of output current can be added without any additional analysis. The ESR of the capacitors is a very important parameter. Power Modules guarantee stable operation with a verified ESR value of >10 mΩ across the output connections.

For further information please contact your local Ericsson Power Modules representative.

Output Voltage Adjust (V_{adj})

The DC/DC converters have an Output Voltage Adjust pin (V_{adj}). This pin can be used to adjust the output voltage above or below Output voltage initial setting.

When increasing the output voltage, the voltage at the output pins (including any remote sense compensation) must be kept below the threshold of the over voltage protection, (OVP) to prevent the converter from shutting down. At increased output voltages the maximum power rating of the converter remains the same, and the max output current must be decreased correspondingly.

To increase the voltage the resistor should be connected between the V_{adj} pin and +Sense pin. The resistor value of the Output voltage adjust function is according to information given under the Output section for the respective product. To decrease the output voltage, the resistor should be connected between the V_{adj} pin and -Sense pin.

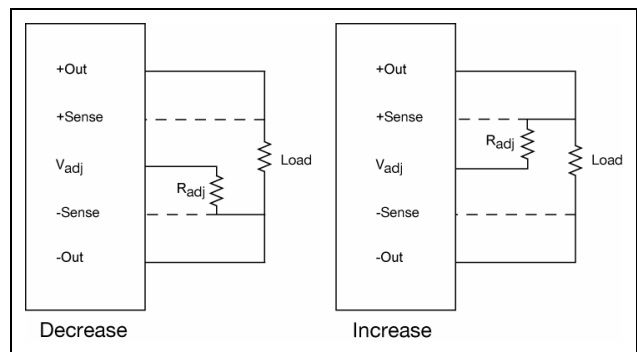

PKL 4000 PI series DC/DC converters, Input 36-75 V, Output 100 A/300 W	EN/LZT 146 311 R2E June 2007 © Ericsson Power Modules AB
---	---

Operating information continued

Parallel Operation

Two converters may be paralleled for redundancy if the total power is equal or less than $P_{O\ max}$. It is not recommended to parallel the converters without using external current sharing circuits.

See Design Note 006 for detailed information.

Remote Sense

The DC/DC converters have remote sense that can be used to compensate for voltage drops between the output and the point of load. The sense traces should be located close to the PCB ground layer to reduce noise susceptibility. The remote sense circuitry will compensate for up to 10% voltage drop between output pins and the point of load.

If the remote sense is not needed +Sense should be connected to +Out and -Sense should be connected to -Out.

Over Temperature Protection (OTP)

The converters are protected from thermal overload by an internal over temperature shutdown circuit. When the baseplate or case temperature exceeds 110°C the converter will shut down immediately(latching). The converter can be restarted by cycling the input voltage or using the remote control function.

Over Voltage Protection (OVP)

The converters have output over voltage protection that will shut down the converter in over voltage conditions. The converter can be restarted by cycling the input voltage or using the remote control function.

Over Current Protection (OCP)

The converters include current limiting circuitry for protection at continuous overload.

The output voltage will decrease towards zero for output currents in excess of max output current ($I_{O\ max}$). The converter will resume normal operation after removal of the overload. The load distribution should be designed for the maximum output short circuit current specified.

Thermal Consideration

General

The converters are designed to operate in different thermal environments and sufficient cooling must be provided to ensure reliable operation.

Cooling is achieved mainly by conduction, from the pins to the host board, and convection, which is dependant on the airflow across the converter. Increased airflow enhances the cooling of the converter.

The Output Current Derating graph found in the Output section for each model provides the available output current vs. ambient air temperature and air velocity at $V_{in} = 53\ V$.

The DC/DC converter is tested on a 254 x 254 mm, 35 μm (1 oz), 16-layer test board mounted vertically in a wind tunnel with a cross-section of 305 x 305 mm.

Proper cooling of the DC/DC converter can be verified by measuring the temperature at positions P1. The temperature at these positions should not exceed the max values provided in the table below.

Note that the max value is the absolute maximum rating (non destruction) and that the electrical Output data is guaranteed up to $T_{ref} + 100^\circ\text{C}$.

See Design Note 019 for further information.

Position	Device	Designation	max value
P1	Baseplate	T_{ref}	100° C



PKL 4000 PI series DC/DC converters, Input 36-75 V, Output 100 A/300 W	EN/LZT 146 311 R2E June 2007 © Ericsson Power Modules AB
---	---

Thermal Consideration continued

Definition of reference temperature (T_{ref})

The reference temperature is used to monitor the temperature limits of the product. Temperatures above maximum T_{ref} are not allowed and may cause degradation or permanent damage to the product. T_{ref} is also used to define the temperature range for normal operating conditions. T_{ref} is defined by the design and used to guarantee safety margins, proper operation and high reliability of the module.

Ambient Temperature Calculation

By using the thermal resistance the maximum allowed ambient temperature can be calculated.

1. The power loss is calculated by using the formula $((1/\eta) - 1) \times \text{output power} = \text{power losses (Pd)}$.
 η = efficiency of converter. E.g 89.5 % = 0.895
2. Find the thermal resistance (R_{th}) in the Thermal Resistance graph found in the Output section for each model.
 Calculate the temperature increase (ΔT).
 $\Delta T = R_{th} \times P_d$
3. Max allowed ambient temperature is:
 Max T_{ref} - ΔT .

E.g PKL4118B PIT at 2m/s:

1. $((\frac{1}{0.852}) - 1) \times 144 \text{ W} = 25.0 \text{ W}$
2. $25.0 \text{ W} \times 1.3^\circ\text{C/W} = 32.5^\circ\text{C}$
3. $110^\circ\text{C} - 32.5^\circ\text{C} = \text{max ambient temperature is } 77.5^\circ\text{C}$

The actual temperature will be dependent on several factors such as the PCB size, number of layers and direction of airflow.

Connections

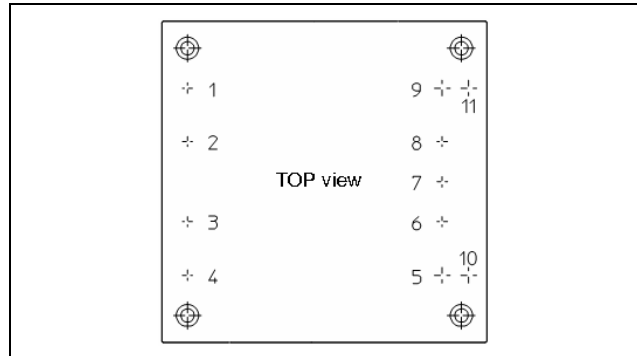

Pin	Designation	Function
1	+In	Positive Input
2	RC	Remote Control
3	Case	Connected to baseplate
4	-In	Negative Input
5,10	-Out	Negative Output
6	-Sen	Negative Sense
7	V _{adj}	Output voltage adjust
8	+Sen	Positive Sense
9,11	+Out	Positive Output

PKL 4000 PI series DC/DC converters, Input 36-75 V, Output 100 A/300 W	EN/LZT 146 311 R2E June 2007 © Ericsson Power Modules AB
---	---

Mechanical information

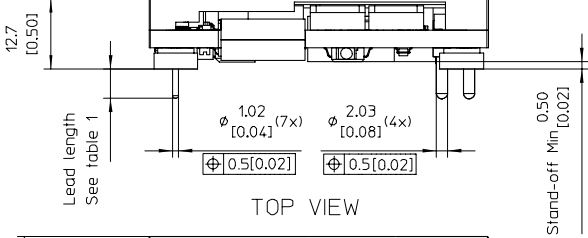

TOP VIEW

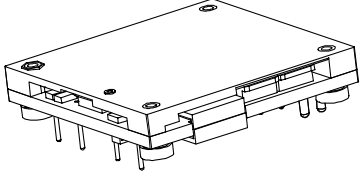
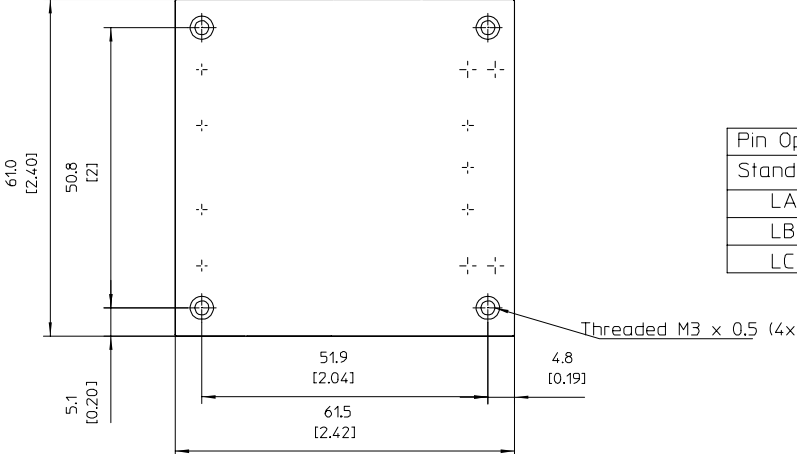
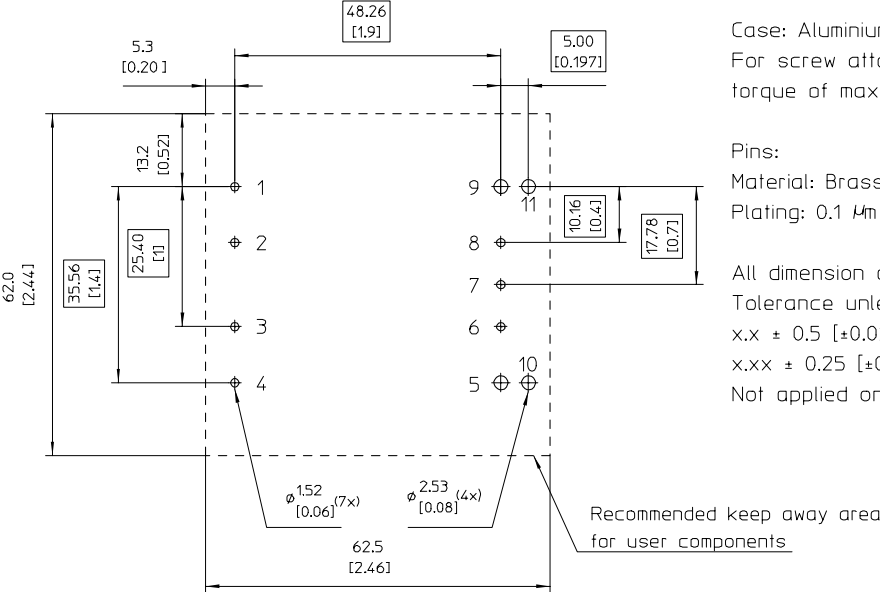

Table 1

Pin Option	Lead Length
Standard	5.33 [0.21]
LA	3.68 [0.145]
LB	4.57 [0.18]
LC	2.80 [0.11]



RECOMMENDED FOOTPRINT - TOP VIEW



Recommended keep away area for user components

Weight: 110 g typical

Case: Aluminium base plate
 For screw attachment apply mounting torque of max 0.44 Nm [3.9 IN-LBS]

Pins:
 Material: Brass
 Plating: 0.1 μm Gold over 2 μm Nickel

All dimension are in mm [inches]
 Tolerance unless specified
 x.x ± 0.5 [±0.02]
 x.xx ± 0.25 [±0.01]
 Not applied on the recommended footprint

PKL 4000 PI series DC/DC converters, Input 36-75 V, Output 100 A/300 W	EN/LZT 146 311 R2E June 2007
	© Ericsson Power Modules AB

Soldering Information – Through hole mounting

The PKL series DC/DC converters are intended for through hole mounting in a PCB. When wave soldering is used max temperature on the pins is specified to 260°C for 10 seconds. Maximum preheat rate of 4°C/s and temperature of max 150°C is suggested. When hand soldering, care should be taken to avoid direct contact between the hot soldering iron tip and the pins for more than a few seconds in order to prevent overheating.

No-clean flux is recommended to avoid entrapment of cleaning fluids in cavities inside of the DC/DC power module. The residues may affect long time reliability and isolation voltage.

Delivery package information

The products are delivered antistatic clamshells.

Tray properties	
Material	PET
Surface resistance	10E5 to 10E12 ohms/square
Bake ability	The clamshells can not be baked
Clamshell capacity	10 converters/clamshell
Box capacity	50 converters (5 full clamshells/box)

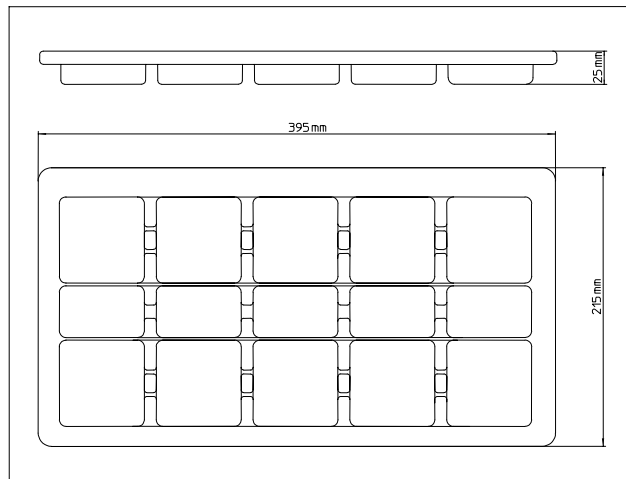

PKL 4000 PI series DC/DC converters, Input 36-75 V, Output 100 A/300 W	EN/LZT 146 311 R2E June 2007
	© Ericsson Power Modules AB

Product Qualification Specification

Characteristics			
External visual inspection	IPC-A-610D		
Change of temperature	IEC 60068-2-14 N _a	Temperature range Duration Cycle	-40 °C-+100 °C 0.5 h 300
Cold	IEC 60068-2-1 A _d	Temperature range Duration Input Voltage Load	-40 °C-+125 °C 72 h Minimum No
Damp heat	IEC 60068-2-3 C _a	Temperature Humidity Input Voltage Duration	+85 °C 85 % RH Maximum 1000 hours
Dry heat	IEC 60068-2-2 B _a	Time Temperature	1000 hours 125 °C
Immersion in cleaning solvents	IEC 60068-2-45 XA Method 2	Water Glycol ether Isopropyl alcohol	+55 ±5 °C +35 ±5 °C +35 ±5 °C
Mechanical shock	IEC 60068-2-27 E _a	Peak acceleration Duration	100 g 6 ms
Operational life test	MIL-STD-202G Method 108A	Case temperature Ambient temperature Input Voltage Load Duration	100 °C 9 °C Minimum Normal ON 9min; OFF 3min 1000h
Resistance to soldering heat (not in operation, without board)	IEC 60068-2-20 T _b Method 1A	Solder Temperature Duration	260 °C 10-13 s
Robustness of terminations	IEC 60068-2-21 U _a		
Solder ability (Precondition 85°C/85%RH; 240h)	IEC 60068-2-20 T _a	SnPb Eutectic Pb Free	235±5 °C 270±5 °C
Vibration, broad-band random	IEC 60068-2-34 E _d	Frequency Acceleration Duration in each direction	10...500 Hz 0.025 g ² /Hz 10 min
Sinusoidal	IEC 60068-2-6 F _c	Frequency Amplitude Acceleration No. of cycles	10-500 Hz 0.75 mm 10 g 10 in each axis