

DC-DC Converter Application Manual

MPD6M031S

1. Features

- Single output/SMD/non-isolated type DC-DC converter with high current (6A).
- High efficiency, low profile and small mounting area have been achieved.
- Wide adjustable output voltage range by connecting external resistance (1.2V to 5.0V).
- Wide operating temperature (-40 °C to +85 °C).
- The synchronizing drive with the external clock(500kHz typ.) is possible.
- ON/OFF function and Short-circuit protection function are built in.

2. Appearance, Dimensions

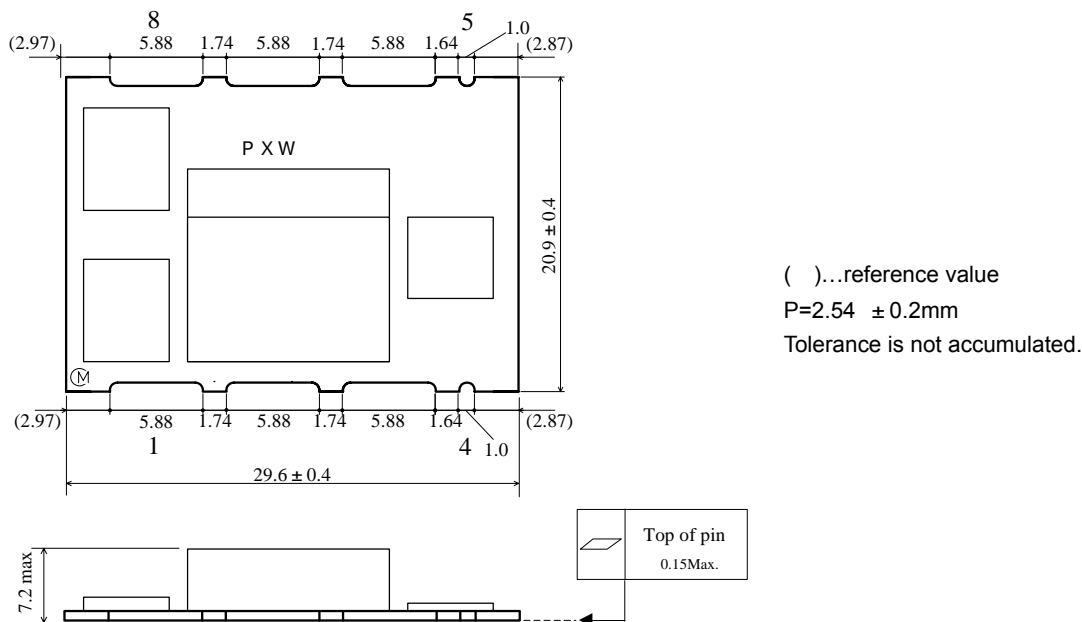

Marking

1. Marking of the product PXW : It means "MPD6M031S"
2. Manufacturer ID
3. Trace code □ □ □ □

⚠ Note:

1. This datasheet is downloaded from the website of Murata Manufacturing co., ltd. Therefore, it's specifications are subject to change or our products in it may be discontinued without advance notice. Please check with our sales representatives or product engineers before ordering.
2. This datasheet has only typical specifications because there is no space for detailed specifications. Therefore, please approve our product specifications or transact the approval sheet for product specifications before ordering.

Pin Number and Function

Pin No.	Symbol	Function
1	Vin	Input
2,8,7	GND	GND
3	SYNC	Synchronous input
4	VAR	Output voltage adjustment
5	ON/OFF	Remote ON/OFF
6	Vout	Output

3. Block Diagram

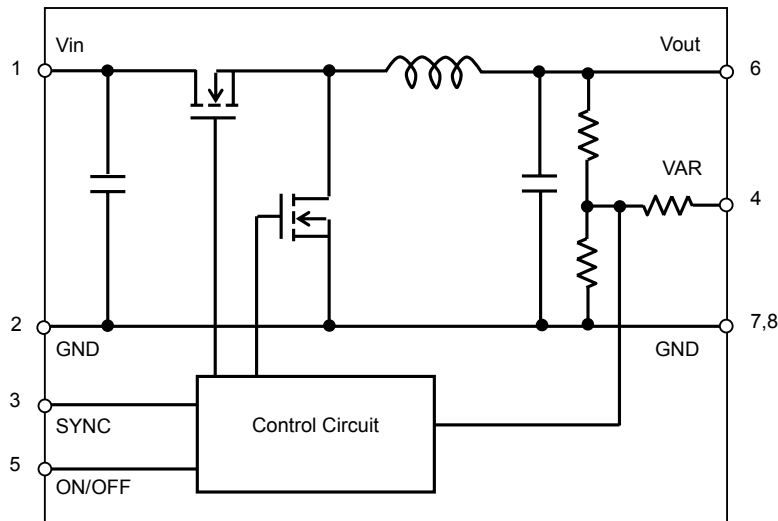

4. Test Circuit

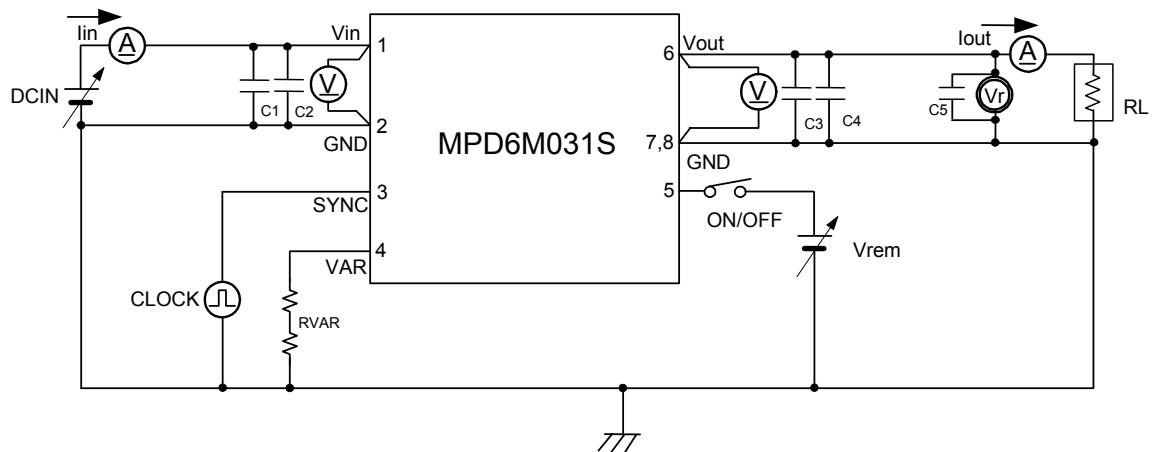

C1,C2 : 10 μ F / 16V Ceramic Capacitor
 C3,C4 : 47 μ F / 6.3V Ceramic Capacitor
 C5 : 0.1 μ F
 RVAR : \pm 1%, 1/16W Chip Resistor

Please make sure to place C1 ,C2,C3 and C4 nearby input and output terminal of DC-DC converter.

⚠ Note:

1. This datasheet is downloaded from the website of Murata Manufacturing co., ltd. Therefore, it's specifications are subject to change or our products in it may be discontinued without advance notice. Please check with our sales representatives or product engineers before ordering.
2. This datasheet has only typical specifications because there is no space for detailed specifications. Therefore, please approve our product specifications or transact the approval sheet for product specifications before ordering.

5. Characteristics

5.1 Electrical Characteristics (Ta=25 °C)

Item	Symbol	Condition	Value			Unit	
			Min.	Typ.	Max.		
Input Voltage Range	Vin		10.8	12.0	13.2	V	
Output Voltage	Vout	Vin=10.8 ~ 13.2V, Fsync=500kHz	VAR=0.22kΩ±1%	4.85	5.00	5.15	V
			VAR=50kΩ±1%	1.164	1.200	1.236	
Output Current	Iout	Vin=10.8 ~ 13.2V, Fsync=500kHz	Vout=1.2V ~ 2.5V	0		6.0	A
			Vout=3.3V ~ 5.0V	0		5.0	
Ripple Voltage	Vrpl	Vin=12V, Vout=2.5V, Iout=6A Fsync=500kHz, BW = 20MHz,	-	50	-	mV(pp)	
Efficiency	EFF	Vin =12V, Vout=2.5V, Iout=6A, Fsync=500kHz	-	90	-	%	
Nominal Frequency Range	Fnom	Vin=10.8 ~ 13.2V	256	320	384	kHz	
Synchronous Frequency Range	Fsync	Vin=10.8 ~ 13.2V	450	500	550	kHz	
ON/OFF pin High Voltage	VIH	Vin=10.8 ~ 13.2V	OFF	2.5		Vin	V
ON/OFF pin Low Voltage	VIL	Vin=10.8 ~ 13.2V	ON	0	-	0.5	V
Short Circuit Protection	SCP	If output is shorted to GND, DC-DC Converter shall be operated in a hiccup mode. After the short circuit event has cleared, the output is automatically brought back into regulation. *Be careful. If output voltage is low, the threshold current of short circuit protection increase.					

⚠ Caution

The above electrical characteristics are guaranteed with the condition that the impedance of the input voltage source is sufficiently low as shown in section 4. Connecting an input inductance or using an input power supply with output inductance may cause an unstable operation of this device. Please check the proper operation of this device with the peripheral circuits on your system.

5.2 Start, Stop Sequence

It is necessary to satisfy the following sequences when this product is started, and stopped. If these sequences are not adhered to production and/or damage may result.

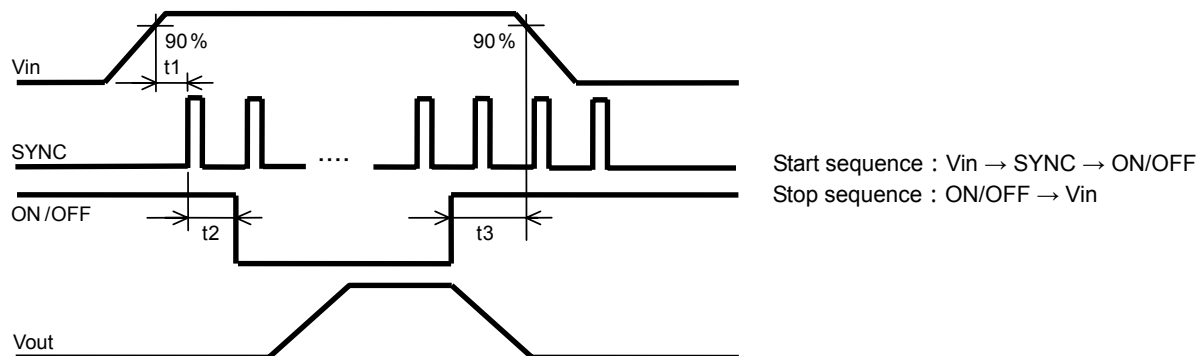

⚠ Note:

t1, t2, t3 > 0

1. This datasheet is downloaded from the website of Murata Manufacturing co., ltd. Therefore, it's specifications are subject to change or our products in it may be discontinued without advance notice. Please check with our sales representatives or product engineers before ordering.
2. This datasheet has only typical specifications because there is no space for detailed specifications. Therefore, please approve our product specifications or transact the approval sheet for product specifications before ordering.

6. Pin Description

6.1. Synchronous external signal

Synchronous clock signals must satisfy the following conditions.

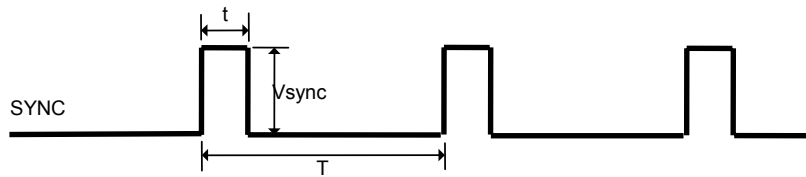

$$F_{\text{sync}} = 1/T = 500 \text{ kHz} \pm 10 \%$$

$$V_{\text{sync}} = 3.3\text{V or } 5.0\text{V}$$

$$t > 100 \text{ ns}$$

$$t/T < 0.5$$

6.2. Adjusting the Output Voltage

The output voltage can be adjusted ranging from 1.2V to 5.0V by connecting resistors between VAR-pin(4pin) to GND-pin.

The following equation gives the required external-resistor values to adjust the output voltage to $V_{o\text{-adj}}$.

It is highly recommended that evaluation of the characteristics of this DC-DC converter's operation under your board conditions be thoroughly conducted.

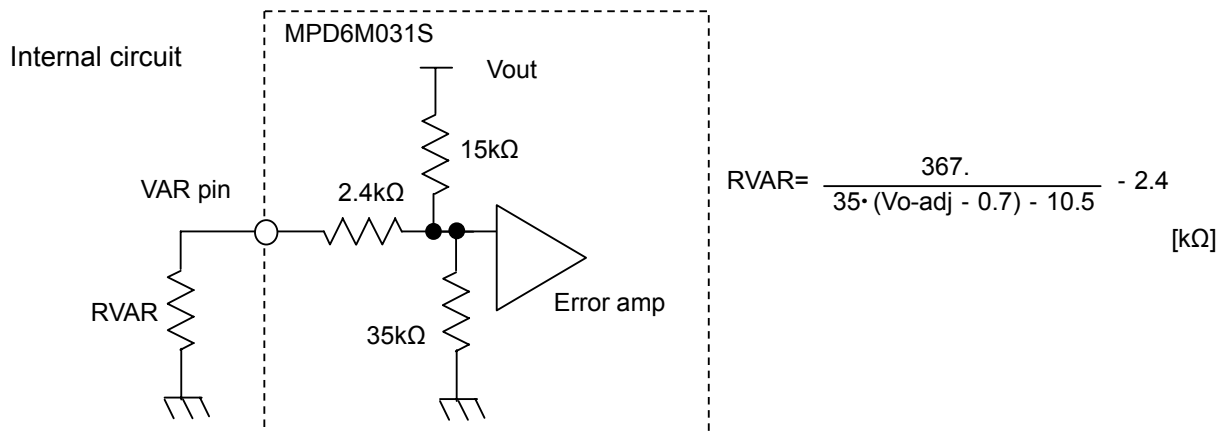

<RVAR Calculation Example>

Vo-adj [V]	Calculated RVAR[kΩ]	RVAR Example
5.0	0.225	220Ω + 0Ω
3.3	2.165	2 kΩ + 160Ω
2.5	4.600	3.6 kΩ + 1kΩ
1.8	10.725	10 kΩ + 750Ω
1.2	50.100	47 kΩ + 3kΩ

6.3. ON/OFF Control

ON/OFF function

Using the ON/OFF feature, the operation of this product can be disabled without removal of the input voltage. Sequencing of a power supply system and power-saving control can be easily achieved using this function.

ON/OFF Control Operation

When ON/OFF-pin(5pin) is connected to V_{in} Output Voltage =OFF
 When ON/OFF-pin(5pin) is connected to GND or open Output Voltage=ON

⚠ Note:

- This datasheet is downloaded from the website of Murata Manufacturing co., ltd. Therefore, it's specifications are subject to change or our products in it may be discontinued without advance notice. Please check with our sales representatives or product engineers before ordering.
- This datasheet has only typical specifications because there is no space for detailed specifications. Therefore, please approve our product specifications or transact the approval sheet for product specifications before ordering.

7. Typical Characteristics Data

7.1 Static Electrical Characteristics

$V_{in}=12V$, $V_o=1.2V$, $F_{sync}=500kHz$
 $(T_a=25^\circ C, C_{in}=GRM31CR71C106KAC7L \times 2, C_{out}=GRM32ER70J476ME20L \times 2, R_{VAR}=50k\Omega)$

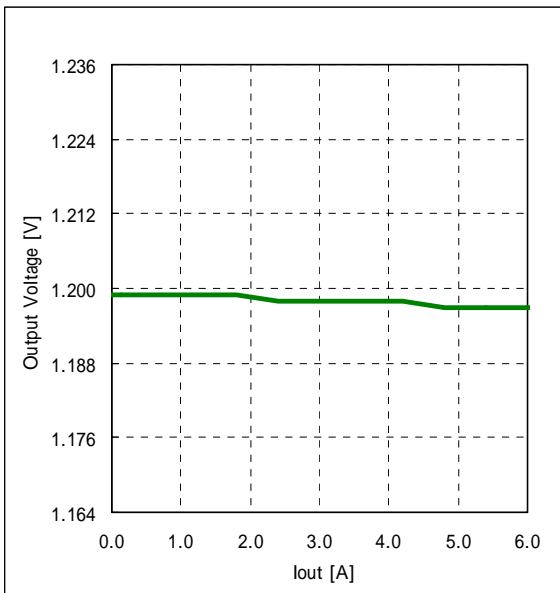

Fig.7-1-1. Output Voltage v.s. Output Current

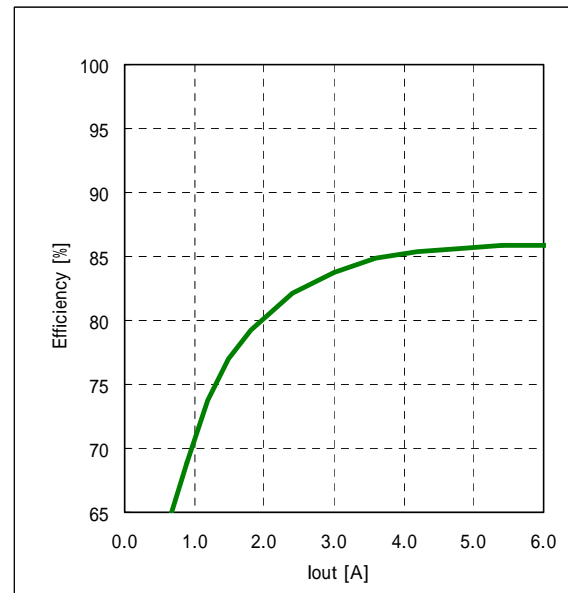

Fig.7-1-2. Efficiency v.s. Output Current

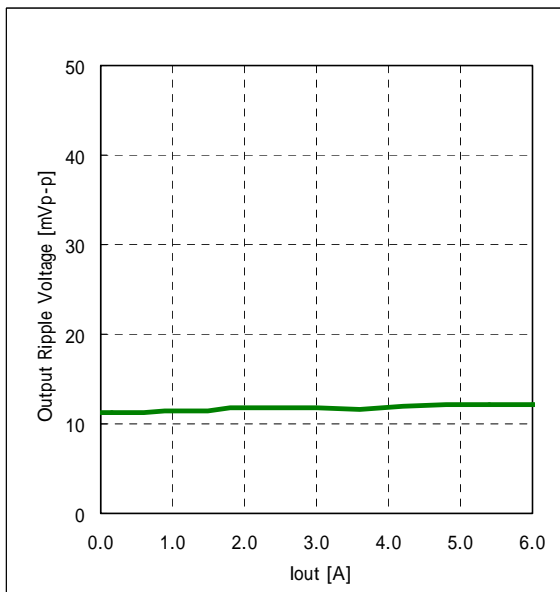

Fig.7-1-3. Ripple Voltage v.s. Output Current

⚠ Note:

1. This datasheet is downloaded from the website of Murata Manufacturing co., ltd. Therefore, it's specifications are subject to change or our products in it may be discontinued without advance notice. Please check with our sales representatives or product engineers before ordering.
2. This datasheet has only typical specifications because there is no space for detailed specifications. Therefore, please approve our product specifications or transact the approval sheet for product specifications before ordering.

$V_{in}=12V$, $V_o=2.5V$, $F_{sync}=500kHz$
 ($T_a=25^\circ C$, $C_{in}=GRM31CR71C106KAC7L\times 2$, $C_{out}=GRM32ER70J476ME20L\times 2$, $R_{VAR}=4.6k\Omega$)

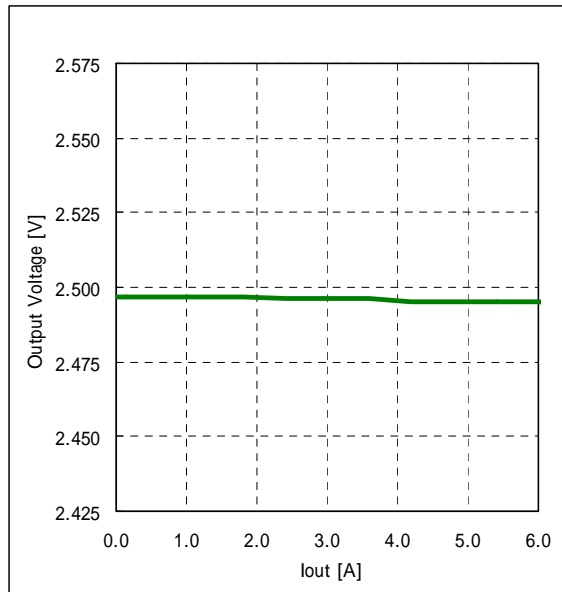

Fig.7-1-4. Output Voltage v.s. Output Current

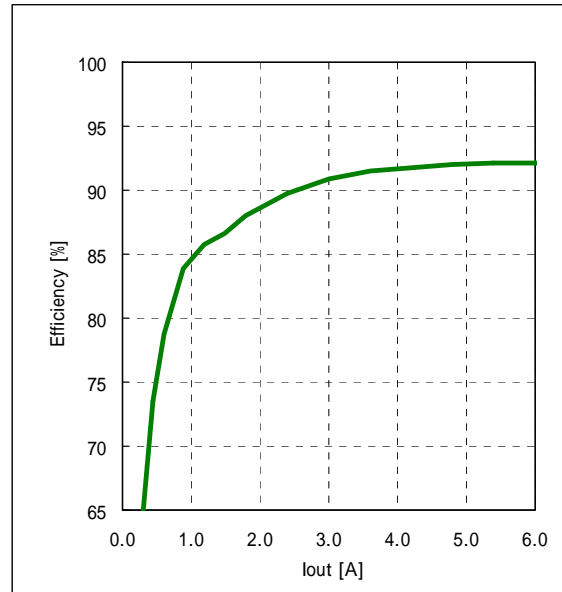

Fig.7-1-5. Efficiency v.s. Output Current

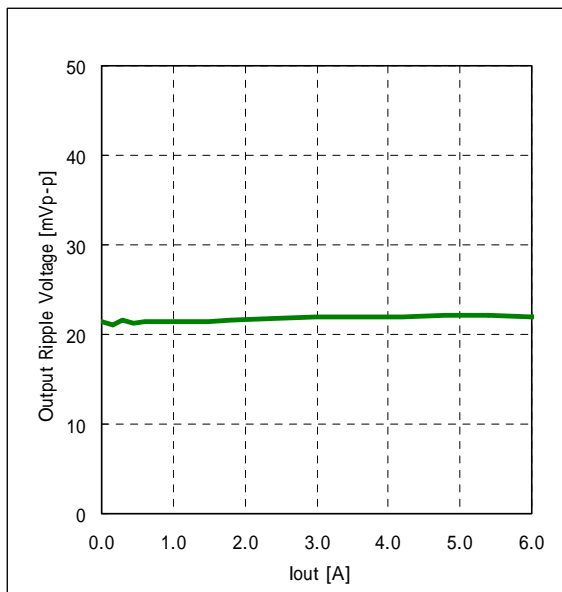

Fig.7-1-6. Ripple Voltage v.s. Output Current

Note:

1. This datasheet is downloaded from the website of Murata Manufacturing co., ltd. Therefore, it's specifications are subject to change or our products in it may be discontinued without advance notice. Please check with our sales representatives or product engineers before ordering.
2. This datasheet has only typical specifications because there is no space for detailed specifications. Therefore, please approve our product specifications or transact the approval sheet for product specifications before ordering.

$V_{in}=12V$, $V_o=3.3V$, $F_{sync}=500kHz$
 ($T_a=25^\circ C$, $C_{in}=GRM31CR71C106KAC7L\times 2$, $C_{out}=GRM32ER70J476ME20L\times 2$, $R_{VAR}=2.16k\Omega$)

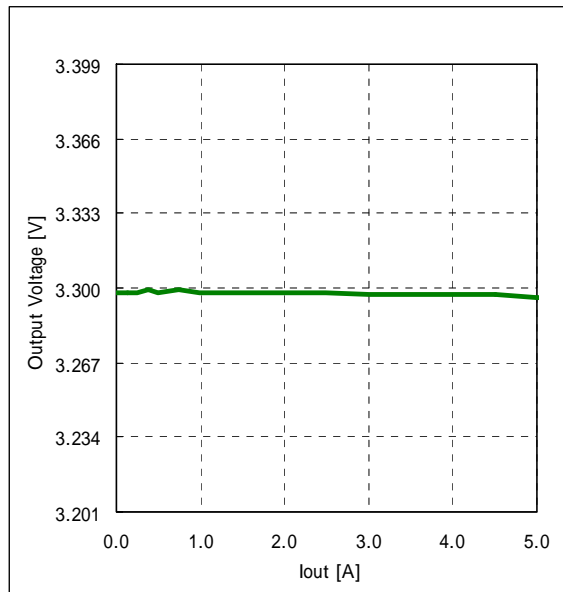

Fig.7-1-7. Output Voltage v.s. Output Current

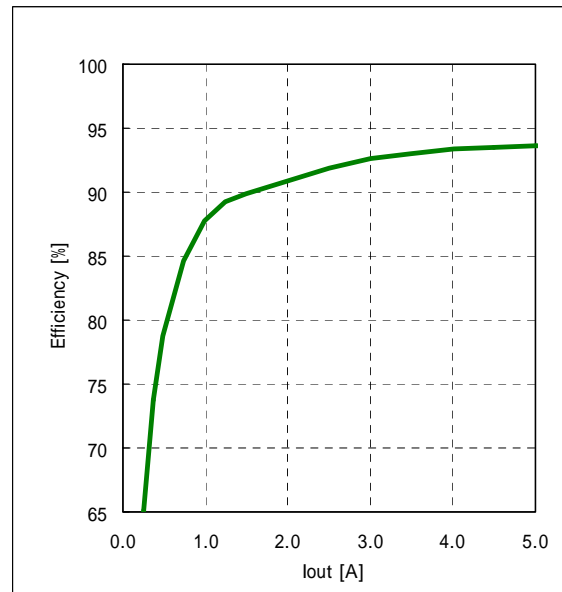

Fig.7-1-8. Efficiency v.s. Output Current

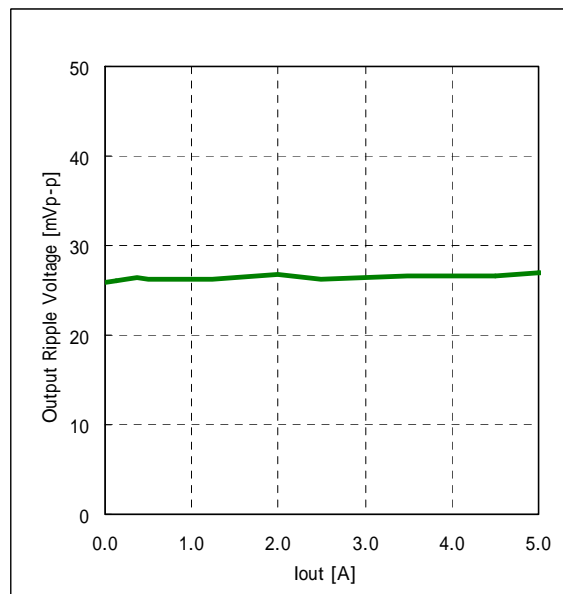

Fig.7-1-9. Ripple Voltage v.s. Output Current

⚠ **Note:**

1. This datasheet is downloaded from the website of Murata Manufacturing co., ltd. Therefore, it's specifications are subject to change or our products in it may be discontinued without advance notice. Please check with our sales representatives or product engineers before ordering.
2. This datasheet has only typical specifications because there is no space for detailed specifications. Therefore, please approve our product specifications or transact the approval sheet for product specifications before ordering.

$V_{in}=12V$, $V_o=5.0V$, $F_{sync}=500kHz$
 ($T_a=25^\circ C$, $C_{in}=GRM31CR71C106KAC7L\times 2$, $C_{out}=GRM32ER70J476ME20L\times 2$, $R_{VAR}=0.22k\Omega$)

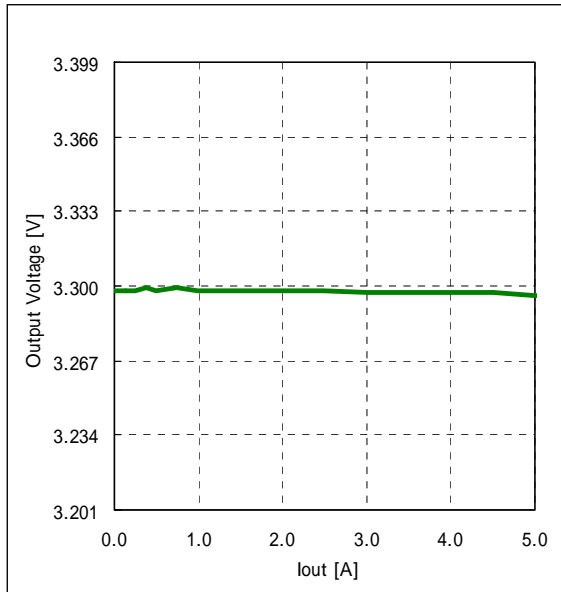

Fig.7-1-10. Output Voltage v.s. Output Current

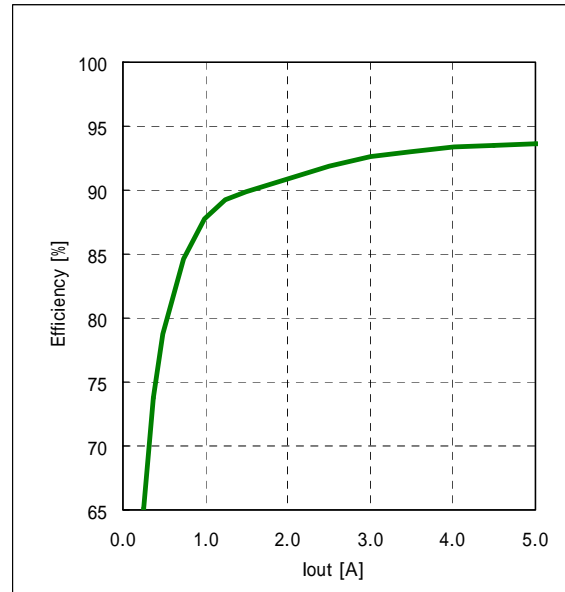

Fig.7-1-11. Efficiency v.s. Output Current

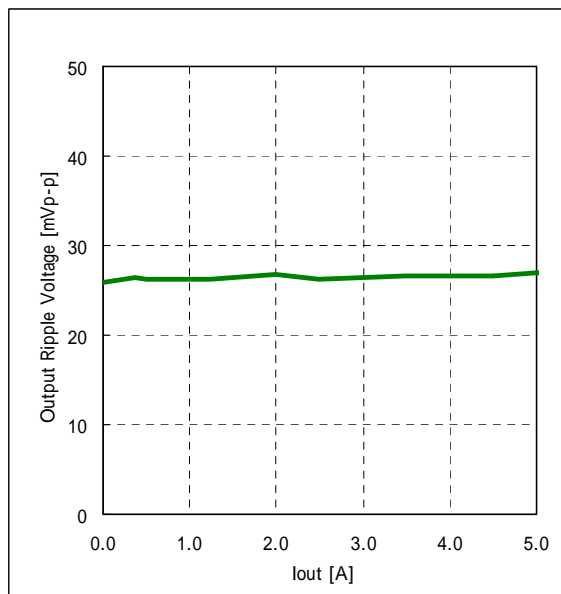

Fig.7-1-12. Ripple Voltage v.s. Output Current

⚠ **Note:**

1. This datasheet is downloaded from the website of Murata Manufacturing co., ltd. Therefore, it's specifications are subject to change or our products in it may be discontinued without advance notice. Please check with our sales representatives or product engineers before ordering.
2. This datasheet has only typical specifications because there is no space for detailed specifications. Therefore, please approve our product specifications or transact the approval sheet for product specifications before ordering.

7.2 Dynamic Electrical Characteristics

$V_{in}=12V$, $V_o=5.0V$, $F_{sync}=500kHz$
 $(T_a=25^\circ C)$, $C_{in}=GRM31CR71C106KAC7L \times 2$, $C_{out}=GRM32ER70J476ME20L \times 2$, $R_{VAR}=50k\Omega$

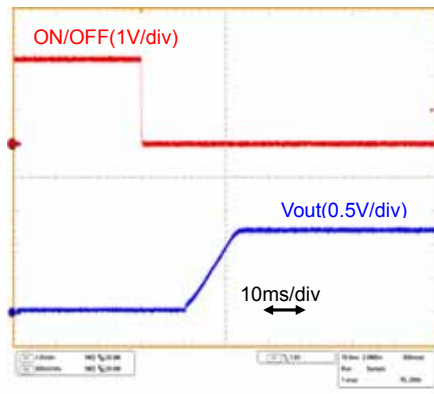
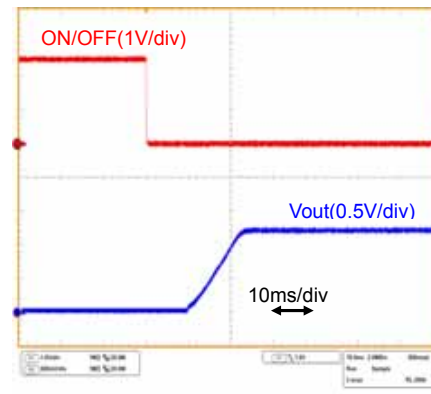
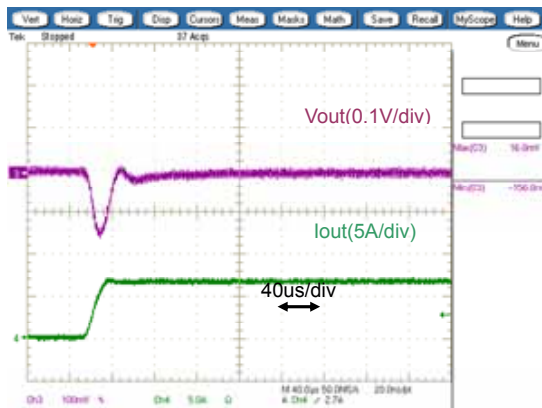
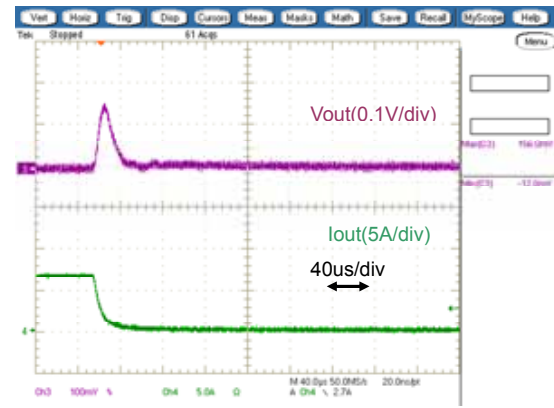
Fig.7-2-1. Start-up Waveform($I_o=0A$)Fig.7-2-2. Start-up Waveform($I_o=6A$)Fig.7-2-3. Load Transient Response
($I_o=0$ 6A)Fig.7-2-4. Load Transient Response
($I_o=6A$ 0A)

⚠ Note:

1. This datasheet is downloaded from the website of Murata Manufacturing co., ltd. Therefore, it's specifications are subject to change or our products in it may be discontinued without advance notice. Please check with our sales representatives or product engineers before ordering.
2. This datasheet has only typical specifications because there is no space for detailed specifications. Therefore, please approve our product specifications or transact the approval sheet for product specifications before ordering.

$V_{in}=12V$, $V_o=2.5V$, $F_{sync}=500kHz$
 ($T_a=25^{\circ}C$, $C_{in}=GRM31CR71C106KAC7L \times 2$, $C_{out}=GRM32ER70J476ME20L \times 2$, $R_{VAR}=4.6k\Omega$)

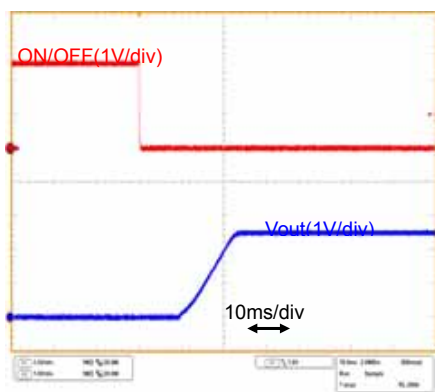

Fig.7-2-5. Start-up Waveform($I_o=0A$)

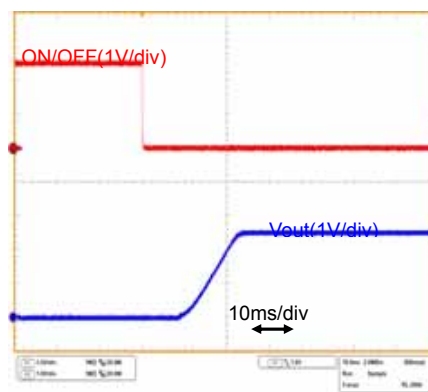

Fig.7-2-6. Start-up Waveform($I_o=6A$)

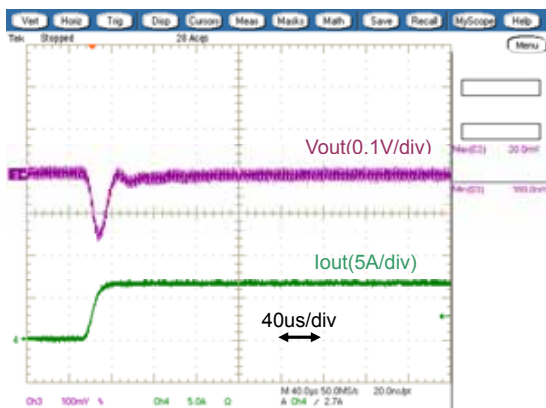

Fig.7-2-7. Load Transient Response
 ($I_o=0$ 6A)

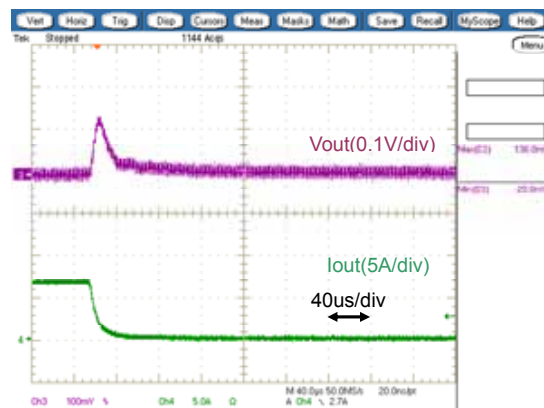

Fig.7-2-8. Load Transient Response
 ($I_o=6A$ 0A)

⚠ **Note:**

1. This datasheet is downloaded from the website of Murata Manufacturing co., ltd. Therefore, it's specifications are subject to change or our products in it may be discontinued without advance notice. Please check with our sales representatives or product engineers before ordering.
2. This datasheet has only typical specifications because there is no space for detailed specifications. Therefore, please approve our product specifications or transact the approval sheet for product specifications before ordering.

$V_{in}=12V$, $V_o=3.3V$, $F_{sync}=500kHz$
 ($T_a=25^\circ C$, $C_{in}=GRM31CR71C106KAC7L \times 2$, $C_{out}=GRM32ER70J476ME20L \times 2$, $R_{VAR}=2.16k\Omega$)

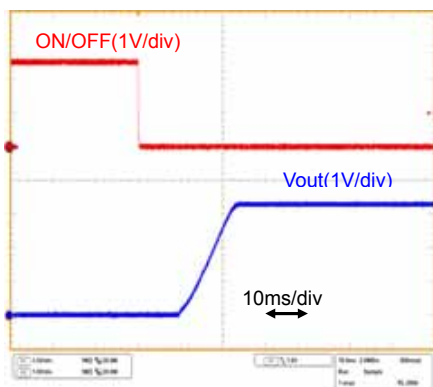

Fig.7-2-9. Start-up Waveform($I_o=0A$)

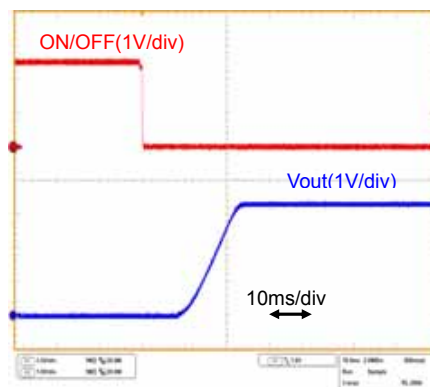

Fig.7-2-10. Start-up Waveform($I_o=5A$)

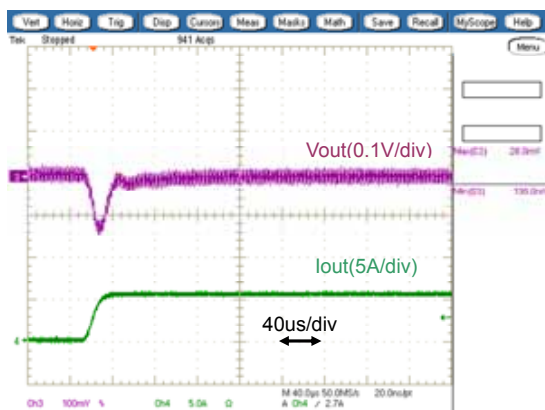

Fig.7-2-11. Load Transient Response
($I_o=0$ 5A)

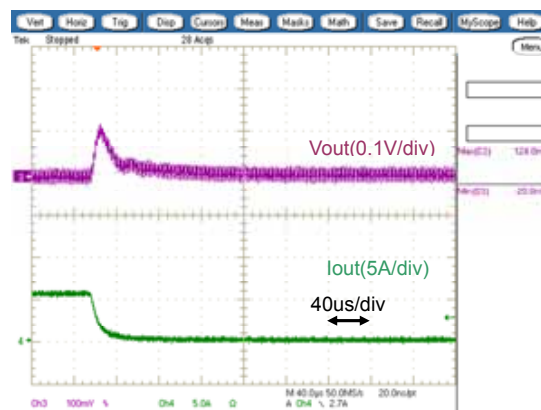

Fig.7-2-12. Load Transient Response
($I_o=5A$ 0A)

Note:

1. This datasheet is downloaded from the website of Murata Manufacturing co., ltd. Therefore, it's specifications are subject to change or our products in it may be discontinued without advance notice. Please check with our sales representatives or product engineers before ordering.
2. This datasheet has only typical specifications because there is no space for detailed specifications. Therefore, please approve our product specifications or transact the approval sheet for product specifications before ordering.

$V_{in}=12V$, $V_o=5.0V$, $F_{sync}=500kHz$
 ($T_a=25^\circ C$, $C_{in}=GRM31CR71C106KAC7L \times 2$, $C_{out}=GRM32ER70J476ME20L \times 2$, $R_{VAR}=0.22k\Omega$)

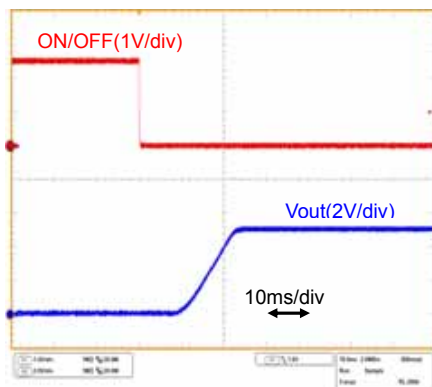

Fig.7-2-13. Start-up Waveform($I_o=0A$)

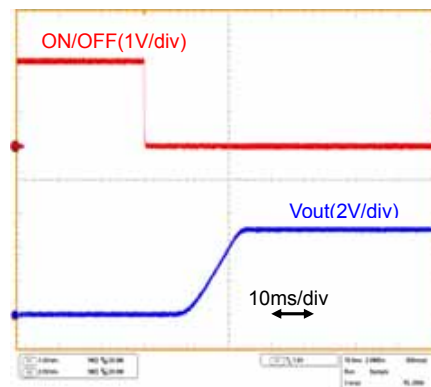

Fig.7-2-14. Start-up Waveform($I_o=5A$)

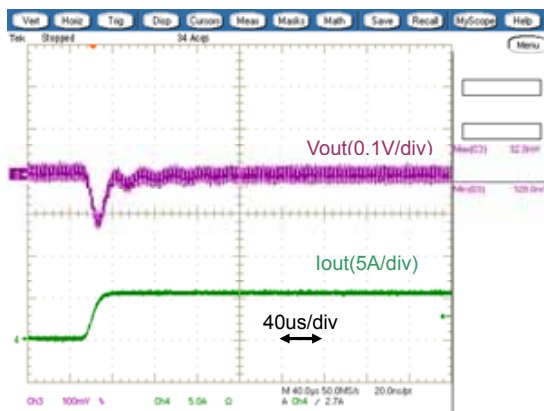

Fig.7-2-15. Load Transient Response
 ($I_o=0$ 5A)

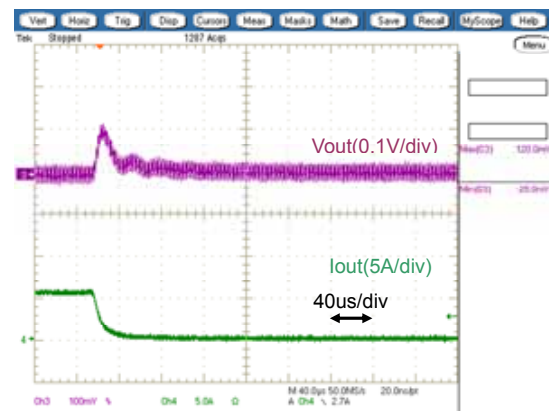

Fig.7-2-16. Load Transient Response
 ($I_o=5A$ 0A)

Note:

1. This datasheet is downloaded from the website of Murata Manufacturing co., ltd. Therefore, it's specifications are subject to change or our products in it may be discontinued without advance notice. Please check with our sales representatives or product engineers before ordering.
2. This datasheet has only typical specifications because there is no space for detailed specifications. Therefore, please approve our product specifications or transact the approval sheet for product specifications before ordering.

8. Mounting Condition

8.1 PCB Land Pattern Recommendation

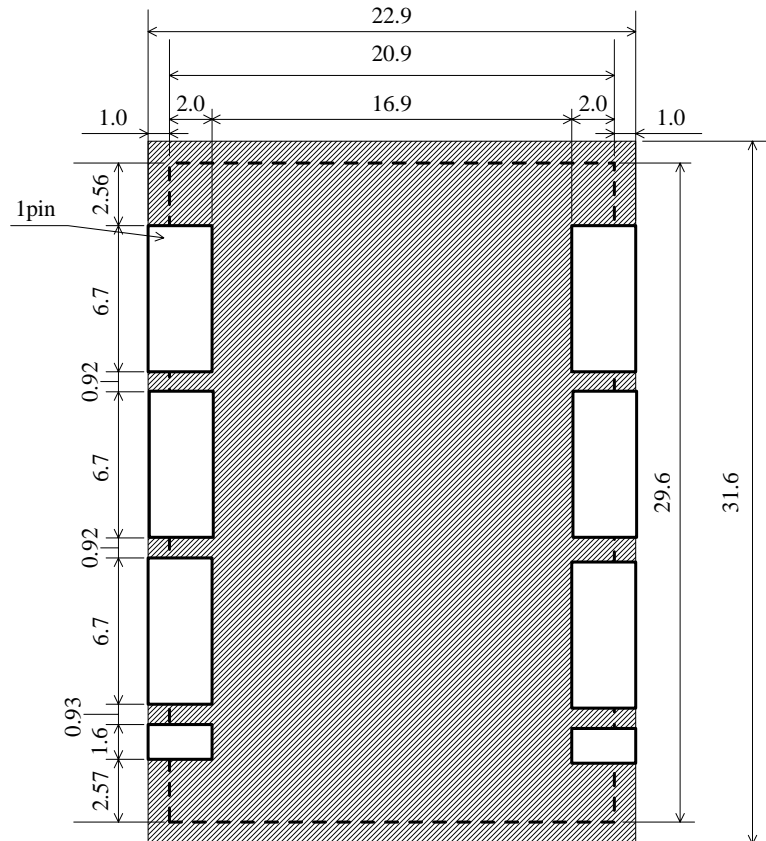

In the above-mentioned chain line area , wirings other than land are assumed to be a prohibition.

There are wiring coppers or through-hole via at the bottom side of the DC-DC converter.

When you design your PCBs, please be careful not to short the circuit of the DC-DC converter or PCBs.

⚠ **Note:**

1. This datasheet is downloaded from the website of Murata Manufacturing Co., Ltd. Therefore, its specifications are subject to change or our products in it may be discontinued without advance notice. Please check with our sales representatives or product engineers before ordering.
2. This datasheet has only typical specifications because there is no space for detailed specifications. Therefore, please approve our product specifications or transact the approval sheet for product specifications before ordering.

8.2 Recommended Soldering Conditions

Reflow Soldering

This product is RoHS compliant. The following profile is recommended for the reflow of this product using Pb-free solder paste (Sn-Ag-Cu).

Method : Full convection reflow soldering

Reflow Soldering Profile

JEDEC IPC/JEDEC J-STD-020D
Table 5-2 Classification Reflow Profile
Pb-Free Assembly Large Body

Profile details

Soldering temperature : 245°C+0/-5°C
Soldering time : 30 seconds, 240 to 245°C
Heating time : 60 to 150 seconds, over 217°C
Preheating time : 60 to 120 seconds, 150 to 200°C
Programming rate : 3°C/ sec. Max., 217 to 245°C
Descending rate : 6°C/ sec. Max.
Total soldering time : 8 minutes Max., 25 to 245°C
Times : 1 time

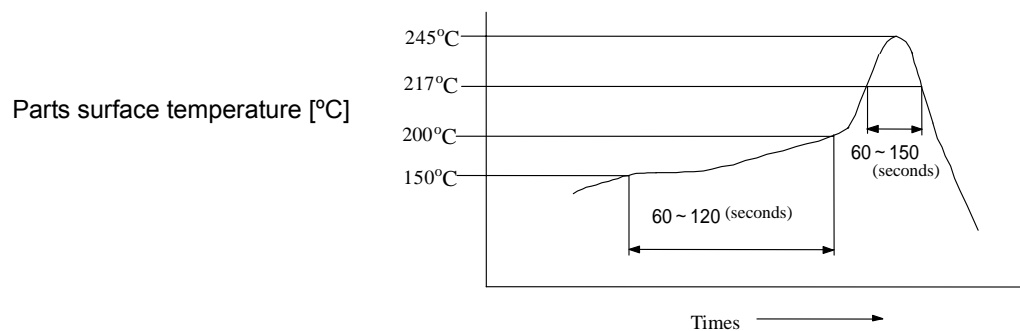

Do not vibrate for the products on reflow.

Please need to take care temperature control because mounted parts may come off if the product are left under the high temperature.

Do not reflow DC-DC converter as follows, because DC-DC converter may fall down from a substrate during reflowing.

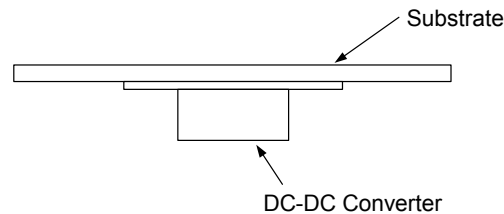

⚠ Note:

1. This datasheet is downloaded from the website of Murata Manufacturing co., ltd. Therefore, it's specifications are subject to change or our products in it may be discontinued without advance notice. Please check with our sales representatives or product engineers before ordering.
2. This datasheet has only typical specifications because there is no space for detailed specifications. Therefore, please approve our product specifications or transact the approval sheet for product specifications before ordering.

9. Packaging Specification

9.1. Packing Form

These are packed in a tray(See Fig.9-1)

9.2. The number of products in pack specification form.

32pcs./tray

If the products have fraction, may not follow this specification.

9.3. Packaging Form

These trays packed products are packaging in a corrugated box alternately.

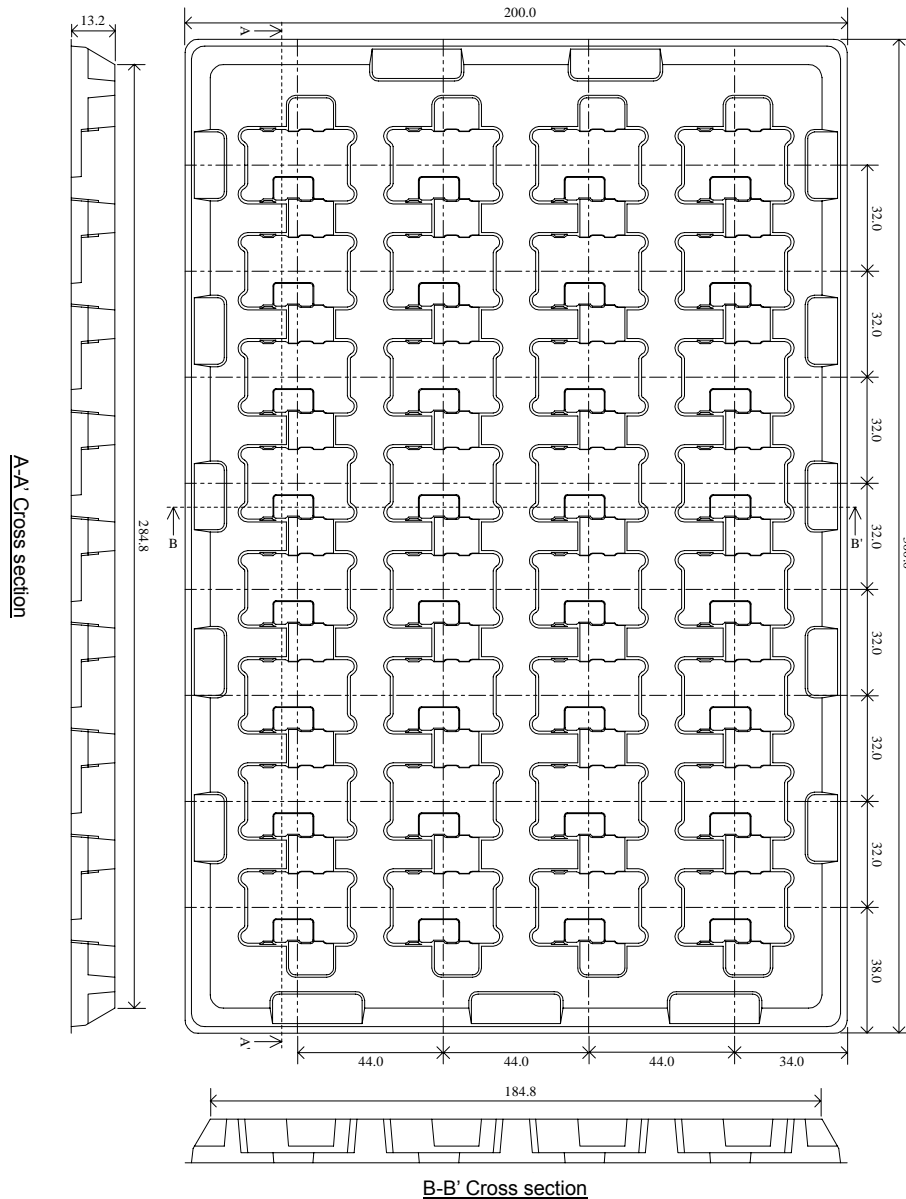

Fig.9-1

⚠ Note:

1. This datasheet is downloaded from the website of Murata Manufacturing co., ltd. Therefore, it's specifications are subject to change or our products in it may be discontinued without advance notice. Please check with our sales representatives or product engineers before ordering.
2. This datasheet has only typical specifications because there is no space for detailed specifications. Therefore, please approve our product specifications or transact the approval sheet for product specifications before ordering.

10.  Notice

10.1. Input / Output capacitor

When an inductance or a switch device are connected to the input line, or when you use a power supply with output inductance as the input voltage source, the input voltage of the DC-DC converter will be fluctuated. By this input voltage fluctuation, the transient load response of the DC-DC converter may be deteriorated or abnormal oscillation may occur. So please confirm normal operation on each application.

Please use external input capacitor in order to decrease inductance of input line.

In case you use external output capacitor in order to improve transient load response, please use input capacitor to prevent abnormal oscillation. When you use external capacitors, following capacitors are recommendable.

Output capacitor (C3+C4) : Please use capacitors less than 300 μ F

10.2. Wiring of input / output capacitor

In the case of input / output capacitor connection, in order to reduce electrical noise, please design PCBs with consideration of the following item.

.Please be sure to check normal operation on your system.

.Please use low impedance capacitors with good high frequency characteristic.

.Please shorten those leads of each capacitor as much as possible, and make sure the lead inductance low.

.Both input-side and output side, please make the wiring loop between plus and minus as small as possible.

.The influence of leakage inductance can be reduced.

.Please design the print pattern of the main circuit as wide and short as possible.

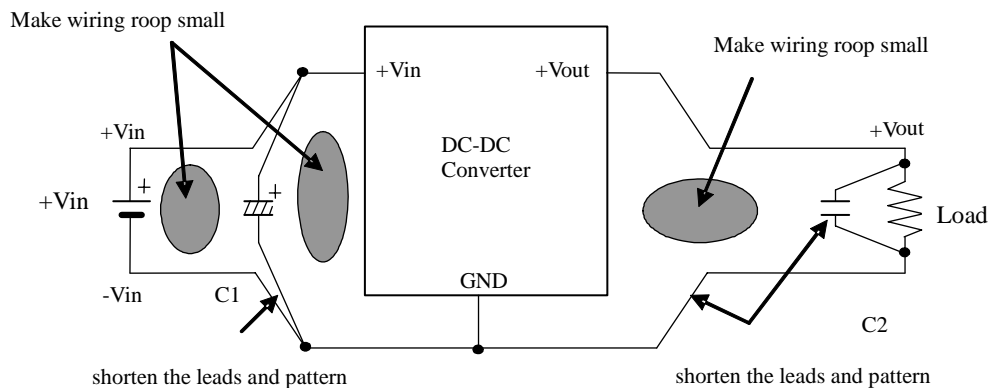

10.3. This product should not be operated in parallel or in series.

10.4. Please do not use a connector or a socket to connect this product to your product.
The electric characteristics may be deteriorated by the influence of contact resistance.

10.5. Be sure to provide an appropriate fail-safe function on your product to prevent secondary damage that may be caused due to abnormal functional or failure of this product.

10.6. Inrush current protection is not a feature of this product.

10.7. Please connect the input terminals with the correct polarity. If an error in polarity connection is made this product may be damaged. If this product is damaged internally, an elevated input current may flow, and so this product may exhibit an abnormal temperature rise, or your product may be damaged. Please add a diode and fuse per the following diagram to protect them.

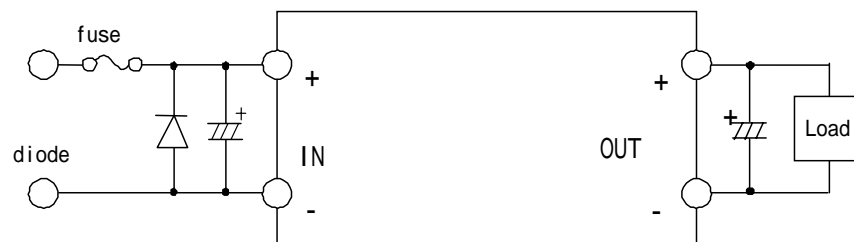

Please select diode and fuse after confirming the operation of your product.

 **Note:**

1. This datasheet is downloaded from the website of Murata Manufacturing co., ltd. Therefore, it's specifications are subject to change or our products in it may be discontinued without advance notice. Please check with our sales representatives or product engineers before ordering.
2. This datasheet has only typical specifications because there is no space for detailed specifications. Therefore, please approve our product specifications or transact the approval sheet for product specifications before ordering.

**Note**

1. Please contact our main sales office or nearby sales office before using our products for the applications listed below which require especially high reliability for the prevention of defects which might directly cause damage to the third party's life, body or property or this products for any other applications that described in the above.

Aircraft equipment
Aerospace equipment
Undersea equipment
Power plant control equipment
Medical equipment
Transportation equipment (vehicles, trains, ships, etc.)
Traffic signal equipment
Disaster prevention /crime prevention equipment
Data-processing equipment
Application of similar complexity and/or reliability requirements to the applications listed in the above.

2. This catalog is indicated in May 2009. About the written contents, since changing without a preliminary announcement for improvement and supply are sometimes stopped, please confirm in case of ordering. If written contents are unknown, please ask to our main sales office or nearby sales office.
3. Types and specification in this catalog are referenced for your information only. Please confirm detailed specifications by approving our individual drawing and specification sheet.

⚠ Note:

1. This datasheet is downloaded from the website of Murata Manufacturing co., ltd. Therefore, it's specifications are subject to change or our products in it may be discontinued without advance notice. Please check with our sales representatives or product engineers before ordering.
2. This datasheet has only typical specifications because there is no space for detailed specifications. Therefore, please approve our product specifications or transact the approval sheet for product specifications before ordering.

