

Austin Lynx™ SMT Non-Isolated dc-dc Power Modules: 3.0 Vdc - 5.5 Vdc Input, 0.9 Vdc - 3.3 Vdc Output, 10 A

RoHS Compliant



Applications

- Workstations, Servers and Desktop computers
- Distributed Power Architectures
- Telecommunications Equipment
- LANs/WANs
- Data processing Equipment
- Latest generation IC's (DSP, FPGA, ASIC) and Microprocessor-powered applications.

Options

- Remote Sense

Description

Austin Lynx™ power modules are non-isolated dc-dc converters that can deliver 10 A of output current with full load efficiency of 95% at 3.3 V output. These open frame modules in surface-mount-package enable designers to develop cost- and space efficient solutions. Standard features include remote ON/OFF, output voltage adjustment, overcurrent and overtemperature protection.

Features

- Compatible with RoHS EU Directive 200295/EC
- Compatible in Pb- free or SnPb reflow environment
- Delivers up to 10A output current
- High efficiency: 95% at 3.3V full load
- Small size and low profile:
33 mm x 13.5 mm x 8.30 mm
(1.3 in x 0.53 in x 0.33 in)
- Light Weight 0.23 oz(6.5 g)
- Cost-efficient open frame design
- High reliability: MTBF > 10M hours at 25 °C
- Constant switching frequency (300 KHz typical)
- Output overcurrent protection with auto-restart
- Overtemperature protection
- Surface Mount Package, Tape and Reel
- Adjustable output voltage (-5% to +10% for 0.9V output)
- Remote On/Off
- Wide Operating temperature range:-40 °C to +85 °C
- UL* 60950 Recognized, CSA† C22.2 No. 60950-00 Certified, and VDE‡ 0805 (IEC60950, 3rd edition) Licensed

* UL is a registered trademark of Underwriters Laboratories, Inc.

† CSA is a registered trademark of Canadian Standards Association.

‡ VDE is a trademark of Verband Deutscher Elektrotechniker e.V.

§ This product is intended for integration into end-use equipment. All the required procedures for CE marking of end-use equipment should be followed. (The CE mark is placed on selected products.)

** ISO is a registered trademark of the International Organization of Standards

Absolute Maximum Ratings

Stresses in excess of the absolute maximum ratings can cause permanent damage to the device. These are absolute stress ratings only, functional operation of the device is not implied at these or any other conditions in excess of those given in the operations sections of the data sheet. Exposure to absolute maximum ratings for extended periods can adversely affect the device reliability.

Parameter	Device	Symbol	Min	Max	Unit
Input Voltage:Continuous	All	VIN	0	6.5	Vdc
Operating Ambient Temperature (See Thermal Considerations section)	All	TA	-40	85	°C
Storage Temperature	All	Tstg	-55	125	°C

Electrical Specifications

Unless otherwise indicated, specifications apply over all operating input voltage, resistive load, and temperature conditions.

Parameter	Device	Symbol	Min	Typ	Max	Unit
Operating Input Voltage	AXH010A0S0R9-SR	VIN	3.0		5.5	Vdc
	AXH010A0S1R0-SR	VIN	3.0		5.5	Vdc
	AXH010A0P-SR	VIN	3.0		5.5	Vdc
	AXH010A0M-SR	VIN	3.0		5.5	Vdc
	AXH010A0Y-SR	VIN	3.0		5.5	Vdc
	AXH010A0D-SR	VIN	3.0		5.5	Vdc
	AXH010A0G-SR	VIN	3.0		5.5	Vdc
	AXH010A0F-SR	VIN	4.5		5.5	Vdc
Maximum Input Current (VI = 0 V to 75 V; IO = IO, max)		II, max			9.5	Adc
Input Reflected Ripple Current, peak-peak (5 Hz to 20 MHz, 1μH source impedance TA = 25 °C; CIN = 200μF)	All	II		30		mAp-p
Input Ripple Rejection (120 Hz)	All			40		dB

CAUTION: This power module is not internally fused. An input line fuse must always be used.

To preserve maximum flexibility, internal fusing is not included; however, to achieve maximum safety and system protection, always use an input line fuse. The safety agencies require a time-delay fuse with a maximum rating of 20A.

Electrical Specifications (continued)

Parameter	Device	Symbol	Min	Typ	Max	Unit
Output Voltage Set Point (VI = 5 Vdc; IO = IO, max, TA = 25 °C)	AXH010A0S0R9-SR	VO,set	0.886	0.9	0.914	Vdc
	AXH010A0S1R0-SR	VO,set	0.985	1.0	1.015	Vdc
	AXH010A0P-SR	VO,set	1.182	1.2	1.218	Vdc
	AXH010A0M-SR	VO,set	1.47	1.5	1.53	Vdc
	AXH010A0Y-SR	VO,set	1.764	1.8	1.836	Vdc
	AXH010A0D-SR	VO,set	1.97	2.0	2.03	Vdc
	AXH010A0G-SR	VO,set	2.45	2.5	2.55	Vdc
	AXH010A0F-SR	VO,set	3.234	3.3	3.366	Vdc
Output Voltage (Over all operating input voltage, resistive load, and temperature conditions at steady state until end of life.)	AXH010A0S0R9-SR	VO	0.873	—	0.927	Vdc
	AXH010A0S1R0-SR	VO	0.970	—	1.03	Vdc
	AXH010A0P-SR	VO	1.164	—	1.236	Vdc
	AXH010A0M-SR	VO	1.455	—	1.545	Vdc
	AXH010A0Y-SR	VO	1.746	—	1.854	Vdc
	AXH010A0D-SR	VO	1.94	—	2.06	Vdc
	AXH010A0G-SR	VO	2.425	—	2.575	Vdc
	AXH010A0F-SR	VO	3.2	—	3.4	Vdc
Output Regulation: Line (VI = VI, min to VI, max) Load (IO = IO, min to IO, max) Temperature (TA = TA, min to TA, max)	All	—	—	0.2	—	%, VO, set
	All	—	—	0.4	—	%, VO, set
	All	—	—	0.5	—	%, VO, set
Output Ripple and Noise Measured across 10 µF Tantalum, 1µF Ceramic,, RMS (5 Hz to 20 MHz bandwidth) Peak-to-peak (5 Hz to 20 MHz bandwidth)	All	—	—	7	15	mVrms
	All	—	—	25	30	mVp-p
Output Current	All	IO	0	—	10	Adc
Output Current-limit Inception (VO = 90% of VO, set)	All	IO, lim	—	17	—	Adc
Output Short-circuit Current (Average)	All	IO, s/c	—	3	—	Adc
Efficiency (VI = VIN, nom; IO = IO, max), TA = 25 °C	AXH010A0S0R9-SR	η	—	83	—	%
	AXH010A0S1R0-SR	η	—	85	—	%
	AXH010A0P-SR	η	—	86	—	%
	AXH010A0M-SR	η	—	88	—	%
	AXH010A0Y-SR	η	—	90	—	%
	AXH010A0D-SR	η	—	91	—	%
	AXH010A0G-SR	η	—	92	—	%
	AXH010A0F-SR	η	—	95	—	%
Switching Frequency	All	f _{sw}	—	300	—	kHz

General Specifications

Parameter	Min	Typ	Max	Unit
Calculated MTBF (IO = 80% of IO, max TA = 25 °C) Lineage RIN (Reliability Information Notebook) Method	10,240,000			Hours
Weight	—	5.5(0.19)	6.5(0.23)	g (oz.)

Feature Specifications

Unless otherwise indicated, specifications apply over all operating input voltage, resistive load, and temperature conditions. See Feature Descriptions for additional information.

Parameter	Device	Symbol	Min	Typ	Max	Unit
Remote On/Off Signal Interface (VI = VI,min to VI, max; open collector npn or Compatible, Von/off signal referenced to GND. See Figure 20 and Feature Descriptions section)						
Logic High (ON/OFF pin open—Module On) Ion/off = 0.0 μA Von/off = VI -0.4	All	Von/off Ion/off			6.5 10	V μA
Logic Low (VON/OFF < 0.3 V)—Module Off Ion/off = 0.5 mA Von/off = 0.3 V	All	Von/off Ion/off			0.3 1	V mA
Turn-on time (IO = 80% of IO, max; VO within ±1% of steady state; see Figure 12)	All	—		5		ms
Output voltage set-point adjustment range (TRIM)	AXH010A0S0R9-SR All others	V _{trim} V _{trim}	-5 -10		+10 +10	%VO, set %VO, set
Overtemperature Protection (shutdown)	All	T _{Q1} /T _{Q2}	—	110	—	°C
Input Undervoltage Lockout						
Turn-on Threshold	All		2.63	2.8	2.95	V
Turn-off Threshold	All		2.47	2.7	2.9	V

Characteristic Curves

The following figures provide typical characteristics curves at room temperature ($T_A = 25\text{ }^\circ\text{C}$).

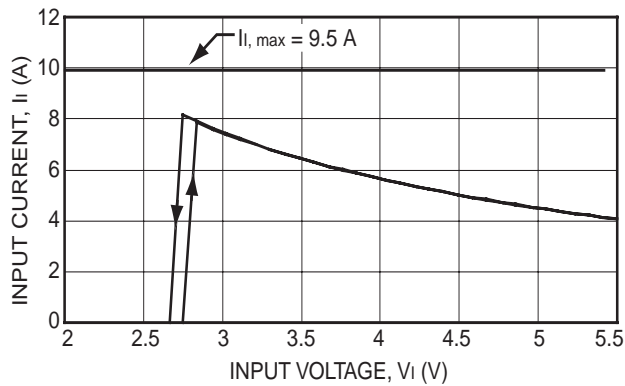

Figure 1. Typical Input Characteristic at 10A Output Current.

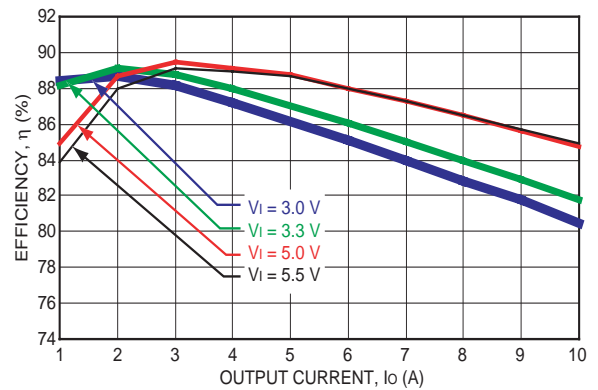

Figure 4. Converter Efficiency vs output current AXH010A0S1R0-SR(1.0V Output Voltage).

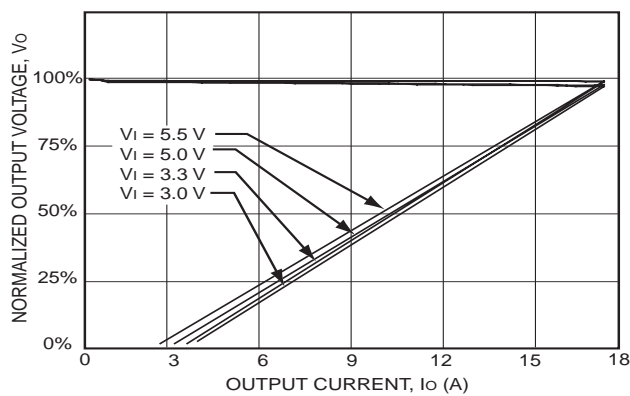

Figure 2. Output Voltage and current characteristics.

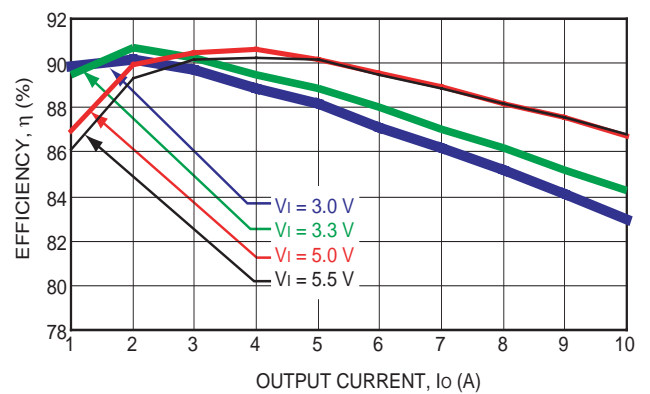

Figure 5. Converter Efficiency vs output current AXH010A0P-SR(1.2V Output Voltage).

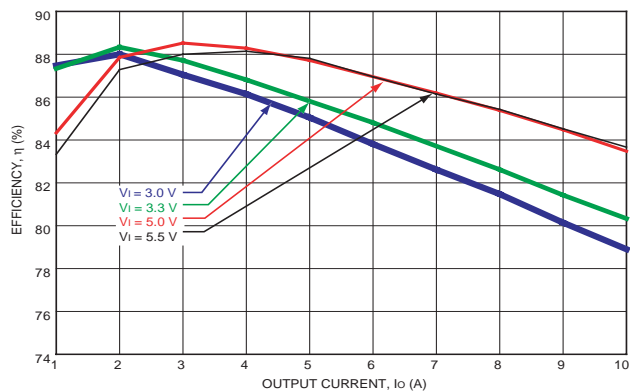

Figure 3. Converter Efficiency vs output current AXH010A0S0R9-SR(0.9V Output Voltage).

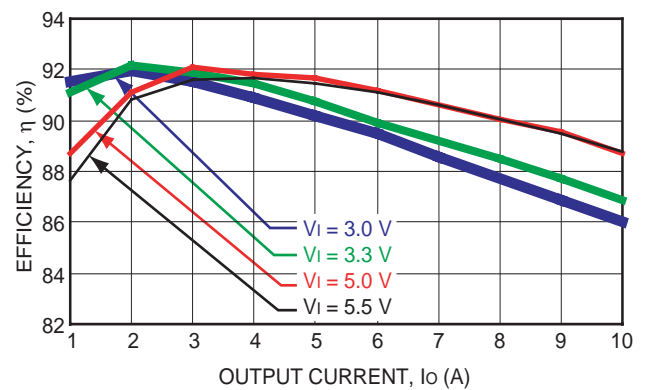

Figure 6. Converter Efficiency vs output current AXH010A0M-SR(1.5V Output Voltage).

Characteristic Curves

The following figures provide typical characteristics curves at room temperature ($T_A = 25\text{ }^\circ\text{C}$)

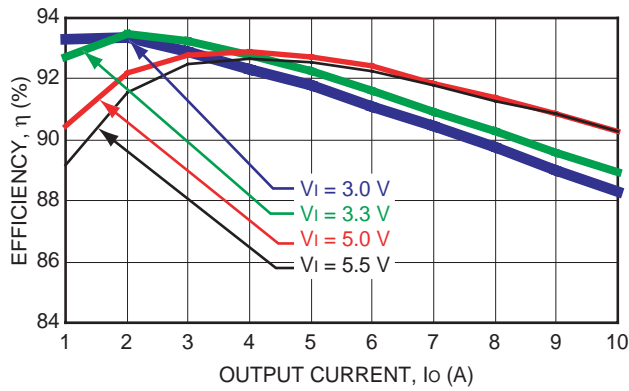

Figure 7. Converter Efficiency vs output current AXH010A0SY-SR(1.8V Output Voltage).

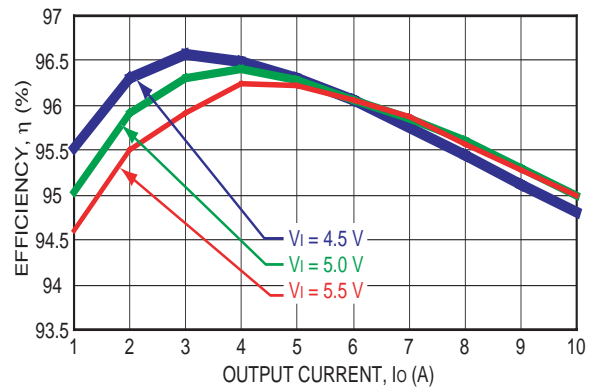

Figure 10. Converter Efficiency vs output current AXH010A0F-SR(3.3V Output Voltage).

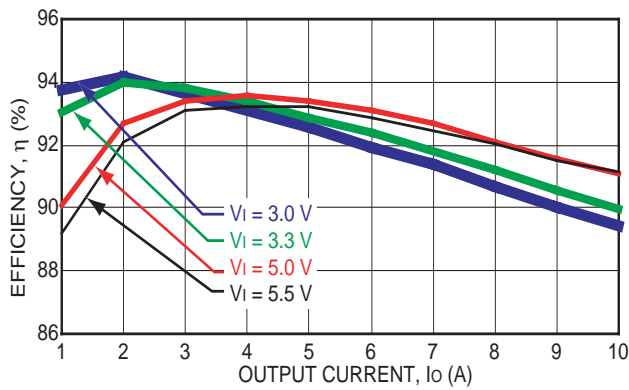

Figure 8. Converter Efficiency vs output current AXH010A0D-SR(2.0V Output Voltage).

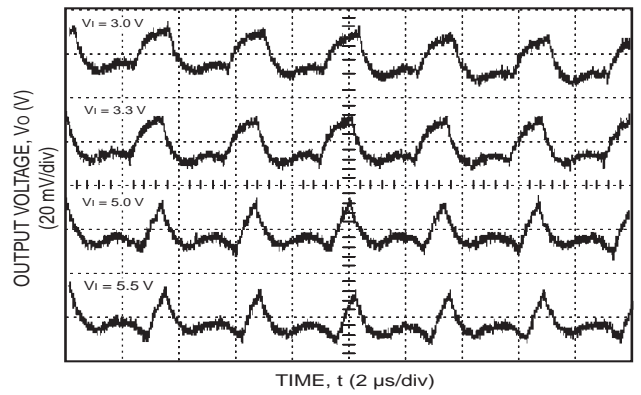

Figure 11. Typical Output Ripple Voltage at 10A Output Current.

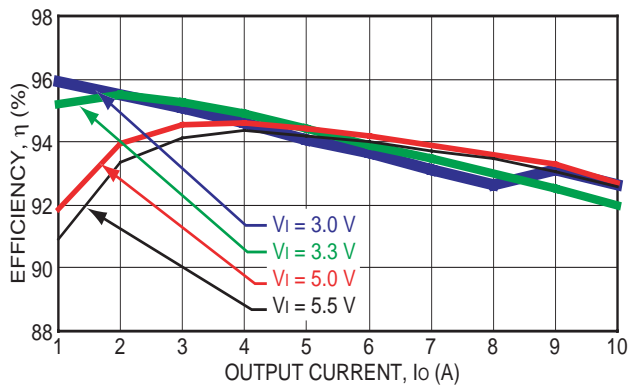

Figure 9. Converter Efficiency vs output current AXH010A0G-SR(2.5V Output Voltage).

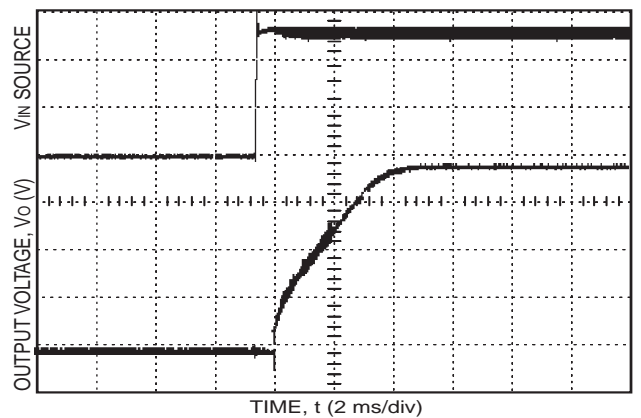

Figure 12. Typical Start-up Transient.

Characteristic Curves

The following figures provide typical characteristics curves at room temperature ($T_A = 25\text{ }^\circ\text{C}$)

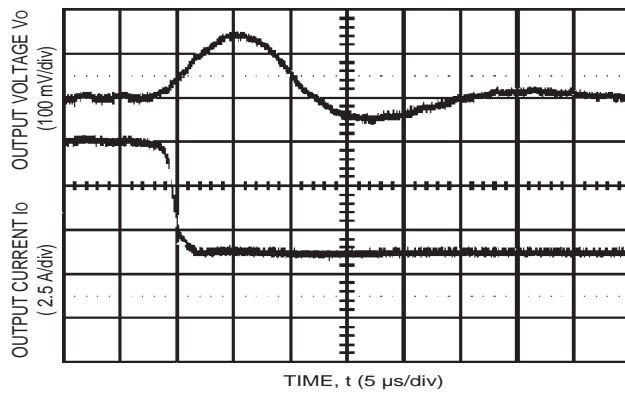

Figure 13. Typical Transient Response to Step Load Change at $2.5\text{ A}/\mu\text{s}$ from 100% to 50% of $I_{O,max}$ at 3.3 V Input (COUT = 1 μF ceramic, 10 μF Tantalum).

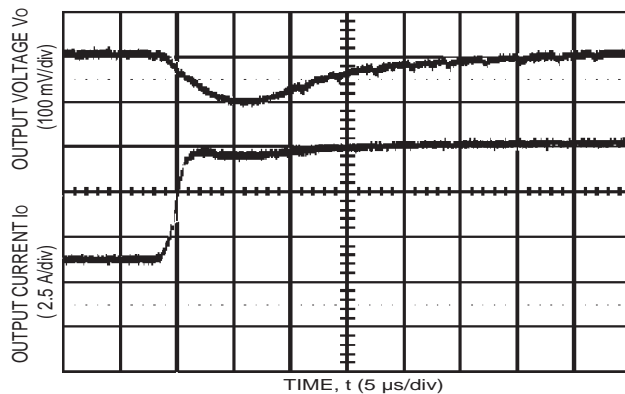
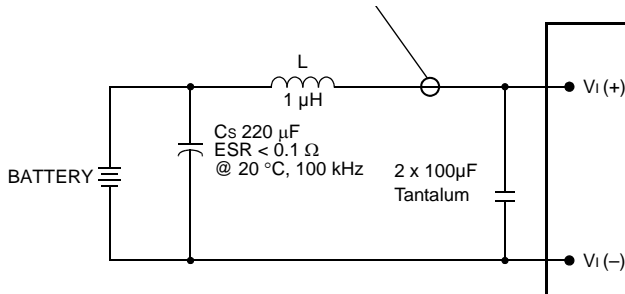

Figure 14. Typical Transient Response to Step Load Change at $2.5\text{ A}/\mu\text{s}$ from 50% to 100% of $I_{O,max}$ at 3.3 V Input (COUT = 1 μF ceramic, 10 μF Tantalum).

Test Configurations



Note: Measure input reflected ripple current with a simulated source inductance (L_{TEST}) of $1\mu\text{H}$. Capacitor CS offsets possible battery impedance. Measure current as shown above.

Figure 15. Input Reflected Ripple Current Test Setup.

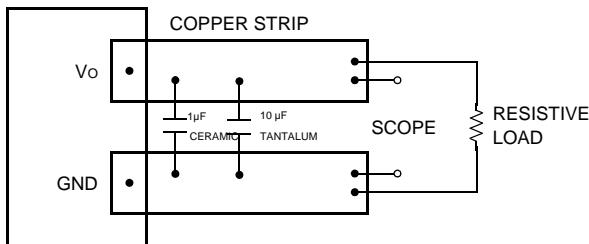

Note: Scope measurements should be made using a BNC socket, with a $10\mu\text{F}$ tantalum capacitor and a $1\mu\text{F}$ ceramic capacitor. Position the load between 51 mm and 76 mm (2 in and 3 in) from the module

Figure 16. Peak-to-Peak Output Ripple Measurement Test Setup.

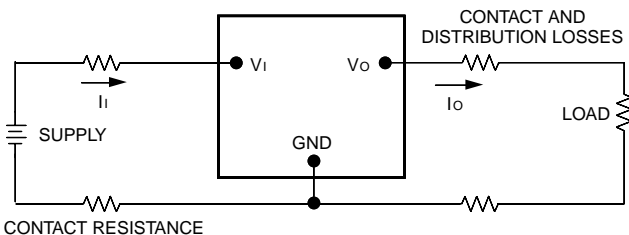

Note: All voltage measurements to be taken at the module terminals, as shown above. If sockets are used then Kelvin connections are required at the module terminals to avoid measurement errors due to socket contact resistance.

Figure 17. Output Voltage and Efficiency Test Setup.

$$\eta = \left(\frac{[V_{O(+)} - V_{O(-)}] \times I_O}{[V_{I(+)} - V_{I(-)}] \times I_I} \right) \times 100$$

Design Considerations

Input Source Impedance

To maintain low-noise and ripple at the input voltage, it is critical to use low ESR capacitors at the input to the module. 18 shows the input ripple voltage (mVp-p) for various output models using a $150\mu\text{F}$ low ESR polymer capacitor (Panasonic p/n: EEFUE0J151R, Sanyo p/n: 6TPE150M) in parallel with $47\mu\text{F}$ ceramic capacitor (Panasonic p/n: ECJ-5YB0J476M,

Taiyo Yuden p/n: CEJMK432BJ476MMT). 19 depicts much lower input voltage ripple when input capacitance is increased to $450\mu\text{F}$ ($3 \times 150\mu\text{F}$) polymer capacitors in parallel with $94\mu\text{F}$ ($2 \times 47\mu\text{F}$) ceramic capacitor.

The input capacitance should be able to handle an AC ripple current of at least:

$$I_{\text{rms}} = I_{\text{out}} \sqrt{\frac{V_{\text{out}}}{V_{\text{in}}} \left[1 - \frac{V_{\text{out}}}{V_{\text{in}}} \right]} \quad A_{\text{rms}}$$

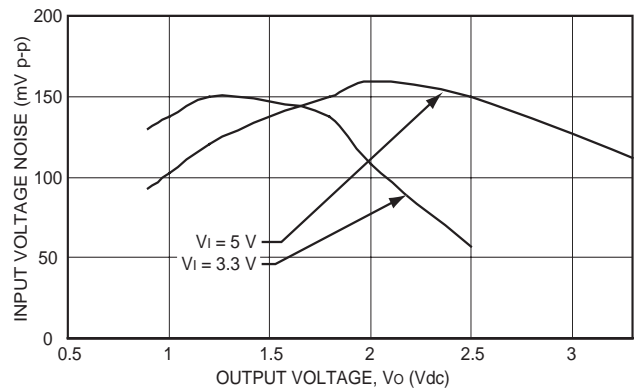

Figure 18. Input Voltage Ripple for Various Output Models, $I_O = 10\text{ A}$ ($C_{IN} = 150\mu\text{F}$ polymer // $47\mu\text{F}$ ceramic).

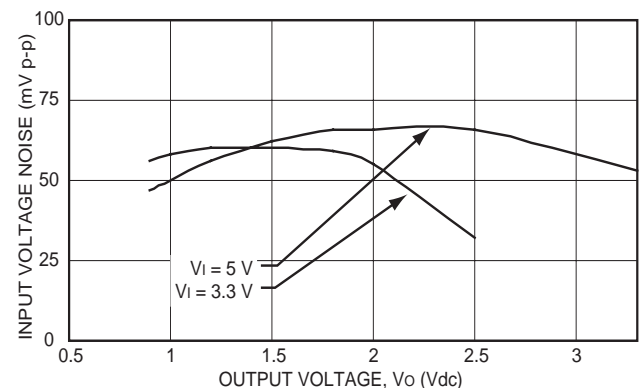

Figure 19. Input Voltage Ripple for Various Output Models, $I_O = 10\text{ A}$ ($C_{IN} = 3 \times 150\mu\text{F}$ polymer // $2 \times 47\mu\text{F}$ ceramic).

Design Considerations (continued)

Input Source Impedance (continued)

The power module should be connected to a low ac-impedance input source. Highly inductive source impedances can affect the stability of the module. An input capacitance must be placed close to the input pins of the module, to filter ripple current and ensure module stability in the presence of inductive traces that supply the input voltage to the module.

Safety Considerations

For safety-agency approval of the system in which the power module is used, the power module must be installed in compliance with the spacing and separation requirements of the end-use safety agency standard, i.e., *UL60950*, *CSA C22.2 No. 60950-00*, and *VDE 0805:2001-12 (IEC60950, 3rd Ed)*.

For the converter output to be considered meeting the requirements of safety extra-low voltage (SELV), the input must meet SELV requirements.

The power module has extra-low voltage (ELV) outputs when all inputs are ELV.

The input to these units is to be provided with a maximum 20 A time-delay fuse in the ungrounded lead.

Feature Descriptions

Remote On/Off

The Austin Lynx™ SMT power modules feature an On/Off pin for remote On/Off operation. If not using the remote On/Off pin, leave the pin open (module will be On). The On/Off pin signal (V_{on/off}) is referenced to ground. To switch the module on and off using remote On/Off, connect an open collector npn transistor between the On/Off pin and the GND pin (see Figure 20).

During a logic-high (On/Off pin is pulled high internal to the module) when the transistor is in the off state the power module is on. The maximum leakage current of the transistor when V_{on/off} = (V_I - 0.4) is 10 μA. The module is Off when the On/Off pin is pulled low (Logic-low) with the transistor in the active state. During this state V_{On/Off} is less than 0.3V and the maximum I_{On/Off} = 1 mA.

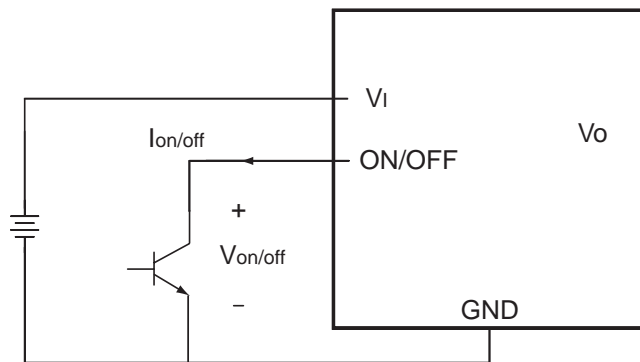

Figure 20. Remote On/Off Implementation.

Output Voltage Set-Point Adjustment (Trim)

Output voltage set-point adjustment allows the output voltage set point to be increased or decreased by connecting either an external resistor or a voltage source between the TRIM pin and either the VO pin (decrease output voltage) or GND pin (increase output voltage).

For TRIM-UP using an external resistor, connect R_{trim-up} between the TRIM and GND pins (21). The value of R_{trim-up} defined as:

$$R_{\text{trim-up}} = \frac{24080}{|\Delta V_{\text{out}}|} - R_{\text{buffer}} \quad \text{k}\Omega$$

|\Delta V_{out}| is the desired output voltage set-point adjustment
R_{buffer} (internal to the module) is defined in Table 1 for various models

Table 1. Austin Lynx™ Trim Values

V _O , set	R _{buffer}
3.3 V	59 kΩ
2.5 V	78.7 kΩ
2.0 V	100 kΩ
1.8 V	100 kΩ
1.5 V	100 kΩ
1.2 V	59 kΩ
1.0 V	30.1 kΩ
0.9 V	5.11 kΩ

Note: V_{O, set} is the typical output voltage for the unit.

For example, to trim-up the output voltage of 1.5V module (AXH010A0M-SR) by 8% to 1.62V, R_{trim-up} is calculated as follows:

$$|\Delta V_{\text{out}}| = 0.12\text{V}$$

$$R_{\text{buffer}} = 100\text{k}\Omega$$

$$R_{\text{trim-up}} = \frac{24080}{0.12} - 100\text{k}$$

$$R_{\text{trim-up}} = 100.66\text{k}\Omega$$

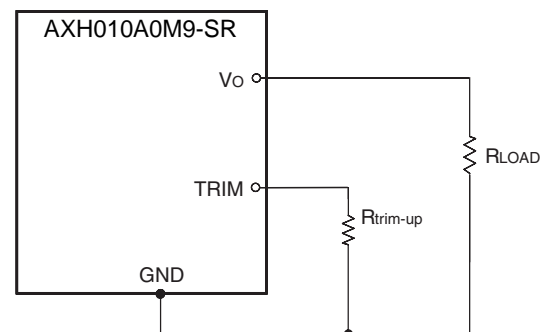

Figure 21. Circuit Configuration to trim-up output voltage.

For trim-down using an external resistor, connect R_{trim-down} between the TRIM and V_{OUT} pins of the module (22). The value of R_{trim-down} is defined as:

$$R_{\text{trim-down}} = \left[\left(\frac{V_{\text{out}} - 0.8}{|\Delta V_{\text{out}}|} - 1 \right) \times 30100 \right] - R_{\text{buffer}} \quad \text{k}\Omega$$

V_{out} is the typical set point voltage of a module

|\Delta V_{out}| is the desired output voltage adjustment

R_{buffer} (internal to the module) is defined in Table 1 for various models

For example, to trim-down the output voltage of 2.5 V module (AXH010G-SR) by 8% to 2.3V, R_{trim-down} is calculated as follows:

Feature Descriptions (continued)

Output Voltage Set-Point Adjustment (Trim) (continued)

$$V_{out} = 2.5V$$

$$R_{buffer} = 78.7k$$

$$R_{trim-down} = \left[\left(\frac{2.5 - 0.8}{0.2} - 1 \right) \times 30100 \right] - 78700$$

$$R_{trim-down} = 147.05k\Omega$$

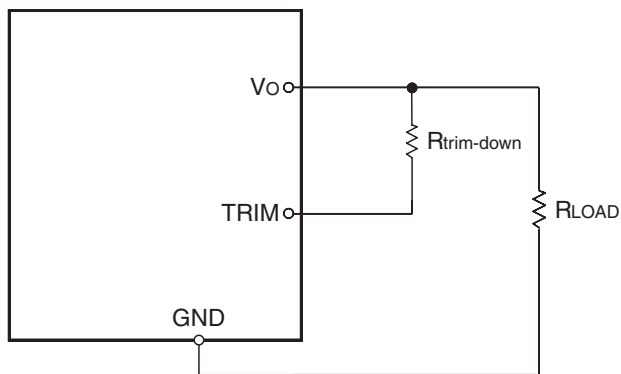

Figure 22. Circuit Configuration to trim-down output voltage.

For Trim-up using an external voltage source, apply a voltage from TRIM pin to ground using the following equation:

$$V_{trim-up} = 0.8 - \left[\Delta V_{out} \times \frac{R_{buffer}}{30100} \right]$$

For Trim-down using an external voltage source, apply a voltage from TRIM pin to ground using the following equation:

$$V_{trim-down} = 0.8 + \left[|\Delta V_{out}| \times \frac{R_{buffer}}{30100} \right]$$

Vtrim-up is the external source voltage for trim-up

Vtrim-down is the external source voltage for trim-down

|\Delta Vout| is the desired output voltage set-point adjustment

Rbuffer (internal to the module) is defined in Table 1 for various models

If the TRIM feature is not being used, leave the TRIM pin disconnected.

Remote Sense

Austin Lynx™ SMT power modules offer an option for a Remote-Sense function. When the Device Code description includes a suffix "3", pin 3 is added to the module and the Remote-Sense is an active feature. See the Ordering Infor-

Lineage Power

mation at the end of this document for more information.

Remote Sense minimizes the effects of distribution losses by regulating the voltage at the load via the SENSE and GND connections (See 23). The voltage between the SENSE pin and VO pin must not exceed 0.5V. Although both the Remote-Sense and Trim features can each increase the output voltage (VO), the maximum increase is not the sum of both. The maximum VO increase is the larger of either the Remote Sense or the Trim.

The amount of power delivered by the module is defined as the output voltage multiplied by the output current (VO x IO). When using SENSE and/or TRIM, the output voltage of the module can increase which, if the same output current is maintained, increases the power output by the module. Make sure that the maximum output power of the module remains at or below the maximum rated power. When pin 3 is present but the Remote Sense feature is not being used, leave Sense pin disconnected.

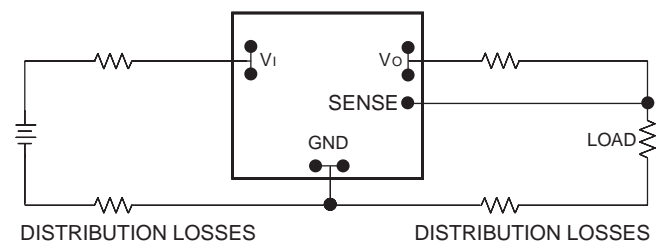

Figure 23. Effective Circuit Configuration for Remote Sense Operation.

Overtemperature Protection

To provide additional protection in a fault condition, the unit is equipped with a nonlatched thermal shutdown circuit. The shutdown circuit engages when Q1 or Q2 (shown in Figure 24) exceeds approximately 110 °C. The unit attempts to restart when Q1 or Q2 cool down and cycles on and off while the fault condition exists. Recovery from shutdown is accomplished when the cause of the overtemperature condition is removed.

Overcurrent Protection

To provide protection in a fault condition, the unit is equipped with internal overcurrent protection. The unit operates normally once the fault condition is removed.

The power module will supply up to 170% of rated current for less than 1.25 seconds before it enters thermal shutdown.

Thermal Considerations

The power module operates in a variety of thermal environments; however, sufficient cooling should be provided to help ensure reliable operation of the unit. Heat is removed by conduction, convection, and radiation to the surrounding environment.

The thermal data presented is based on measurements taken in a wind tunnel. The test setup shown in Figure 25 was used to collect data for Figures 26 and 27. Note that the airflow is parallel to the short axis of the module as shown in Figure 24. The derating data applies to airflow along either direction of the module's short axis.

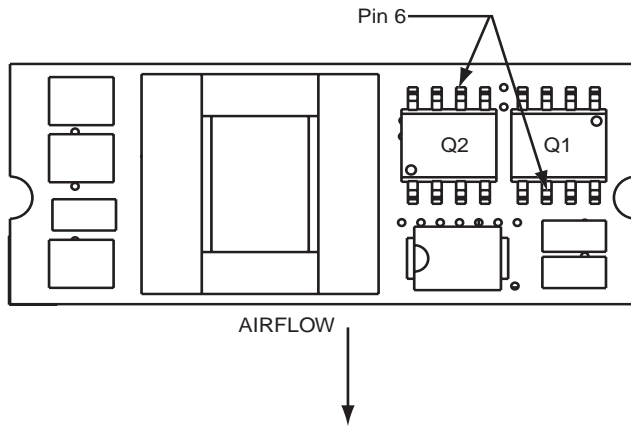

Figure 24. Temperature Measurement Location.

The temperature at either location should not exceed 110 °C. The output power of the module should not exceed the rated power for the module (VO, set x IO, max).

Convection Requirements for Cooling

To predict the approximate cooling needed for the module, refer to the Power Derating curves in Figures 26 and 27.

These derating curves are approximations of the ambient temperatures and airflows required to keep the power module temperature below its maximum rating. Once the module is assembled in the actual system, the module's temperature should be checked as shown in Figure 24 to ensure it does not exceed 110 °C.

Proper cooling can be verified by measuring the power module's temperature at Q1-pin 6 and Q2-pin 6 as shown in Figure 24.

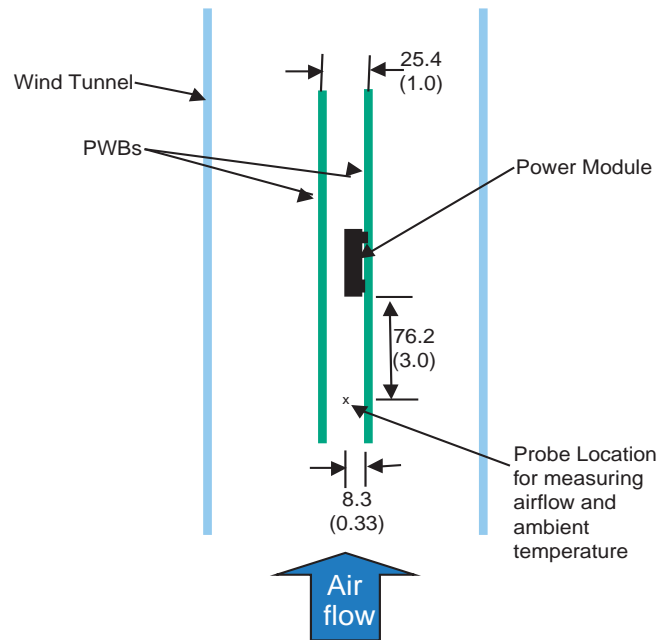

Figure 25. Thermal Test Setup.

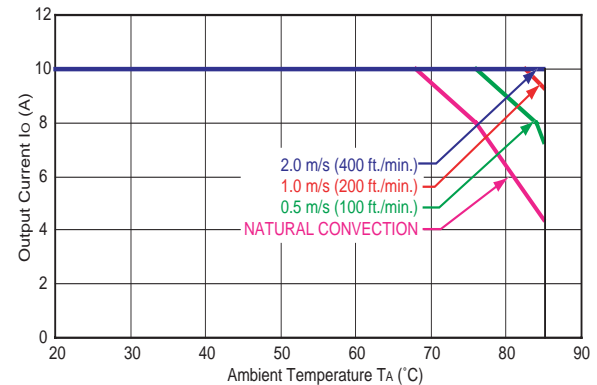

Figure 26. Typical Power Derating Vs Output Current for 3.3 VIN.

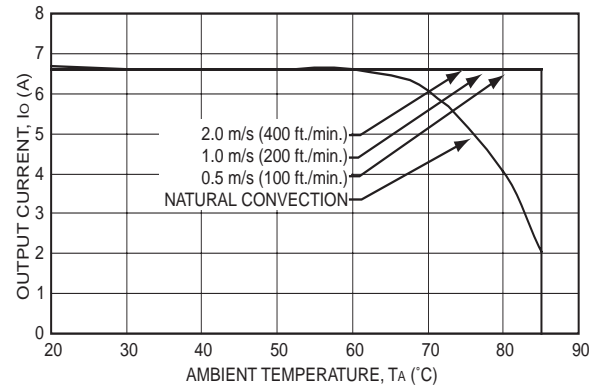

Figure 27. Typical Power Derating Vs Output Current for 5.0VIN.

Layout Considerations

Copper paths must not be routed beneath the power module.

Surface Mount Information

Pick and Place Area

Although the module weight is minimized by using open-frame construction, the modules have a relatively large mass compared to conventional surface-mount components. To optimize the pick-and-place process, automated vacuum equipment variables such as nozzle size, tip style, vacuum pressure, and placement speed should be considered. Austin Lynx™ SMT modules have a flat surface which serves as a pick-and-place location for automated vacuum equipment. The module's pick-and-place location is identified by the target symbol on the top label as shown in Figure 28.

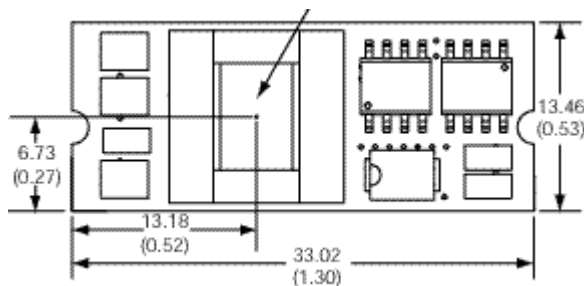

Figure 28. Pick and Place Location.

Nozzle Recommendations

The module weight has been kept to a minimum by using open frame construction. Even so, these modules have a relatively large mass when compared to conventional SMT components. Variables such as nozzle size, tip style, vacuum pressure and pick & placement speed should be considered to optimize this process. The minimum recommended nozzle diameter for reliable operation is 3mm. The maximum nozzle outer diameter, which will safely fit within the allowable component spacing, is 12 mm max.

Tin Lead Soldering

The Austin Lynx™ SMT power modules are lead free modules and can be soldered either in a lead-free solder process or in a conventional Tin/Lead (Sn/Pb) process. It is recommended that the customer review data sheets in order to customize the solder reflow profile for each application board assembly. The following instructions must be observed when soldering these units. Failure to observe these instructions may result in the failure of or cause damage to the modules, and can adversely affect long-term reliability.

In a conventional Tin/Lead (Sn/Pb) solder process peak reflow temperatures are limited to less than 235°C. Typically, the eutectic solder melts at 183°C, wets the land, and subsequently wicks the device connection. Sufficient time must be

Lineage Power

allowed to fuse the plating on the connection to ensure a reliable solder joint. There are several types of SMT reflow technologies currently used in the industry. These surface mount power modules can be reliably soldered using natural forced convection, IR (radiant infrared), or a combination of convection/IR. For reliable soldering the solder reflow profile should be established by accurately measuring the modules CP connector temperatures.

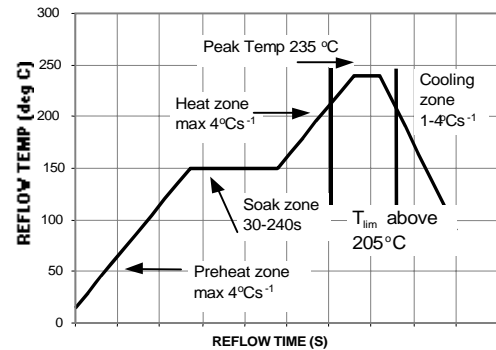

Figure 29. Reflow Profile.

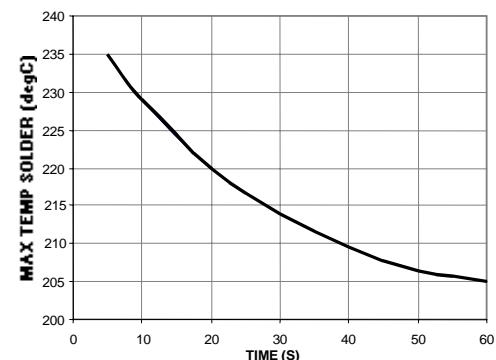

Figure 30. Time Limit curve above 205°C.

Lead Free Soldering

The -Z version Austin Lynx SMT modules are lead-free (Pb-free) and RoHS compliant and are both forward and backward compatible in a Pb-free and a SnPb soldering process. Failure to observe the instructions below may result in the failure of or cause damage to the modules and can adversely affect long-term reliability.

Pb-free Reflow Profile

Power Systems will comply with J-STD-020 Rev. C (Moisture/Reflow Sensitivity Classification for Nonhermetic Solid State Surface Mount Devices) for both Pb-free solder profiles and MSL classification procedures. This standard provides a recommended forced-air-convection reflow profile based on the volume and thickness of the package (table 4-2). The suggested Pb-free solder paste is Sn/Ag/Cu (SAC). The recommended linear reflow profile using Sn/Ag/Cu solder is shown in Figure. 31.

Surface Mount Information (continued)

MSL Rating

The Austin Lynx™ SMT modules have a MSL rating of 1.

Storage and Handling

The recommended storage environment and handling procedures for moisture-sensitive surface mount packages is detailed in J-STD-033 Rev. A (Handling, Packing, Shipping and Use of Moisture/Reflow Sensitive Surface Mount Devices). Moisture barrier bags (MBB) with desiccant are required for MSL ratings of 2 or greater. These sealed packages should not be broken until time of use. Once the original package is broken, the floor life of the product at conditions of $\pm 30^{\circ}\text{C}$ and 60% relative humidity varies according to the MSL rating (see J-STD-033A). The shelf life for dry packed SMT packages will be a minimum of 12 months from the bag seal date, when stored at the following conditions: $< 40^{\circ}\text{C}$, $< 90\%$ relative humidity.

Post Solder Cleaning and Drying Considerations

Post solder cleaning is usually the final circuit-board assembly process prior to electrical board testing. The result of inadequate cleaning and drying can affect both the reliability of a power module and the testability of the finished circuit-board assembly. For guidance on appropriate soldering, cleaning and drying procedures, refer to Lineage Power *Board Mounted Power Modules: Soldering and Cleaning* Application Note (AP01-056EPS).

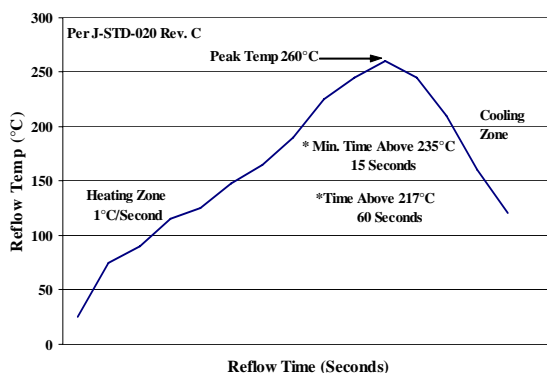

Figure 31. Recommended linear reflow profile using Sn/Ag/Cu solder.

Solder Ball and Cleanliness Requirements

The open frame (no case or potting) power module will meet the solder ball requirements per J-STD-001B. These requirements state that solder balls must neither be loose nor violate the power module minimum electrical spacing.

The cleanliness designator of the open frame power module is C00 (per J specification).

Surface-Mount Tape and Reel

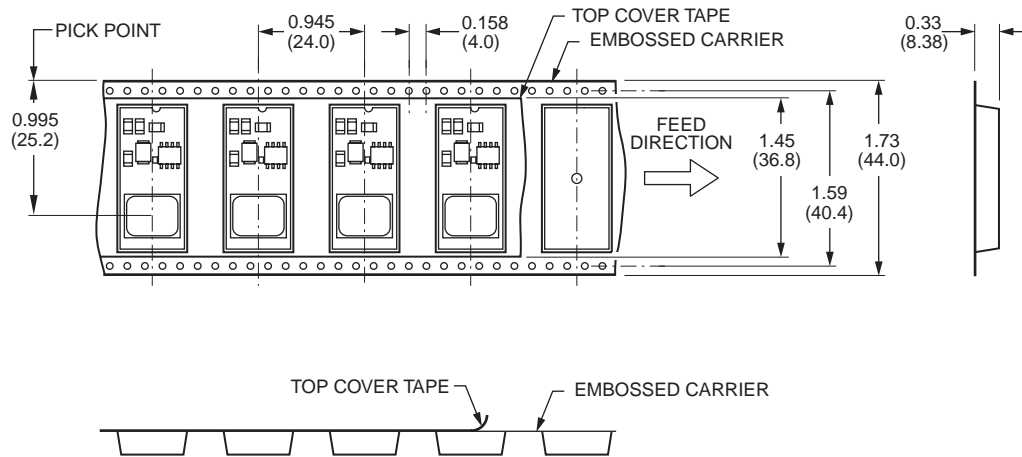

NOTE: CONFORMS TO EAI-481 REV. A STANDARD

Mechanical Outline Diagram

Dimensions are in millimeters and (inches).

Tolerances: $x.x \pm 0.5$ mm (0.02 in.), $x.xx \pm 0.25$ mm (0.010 in.), unless otherwise noted.

BOTTOM VIEW OF BOARD

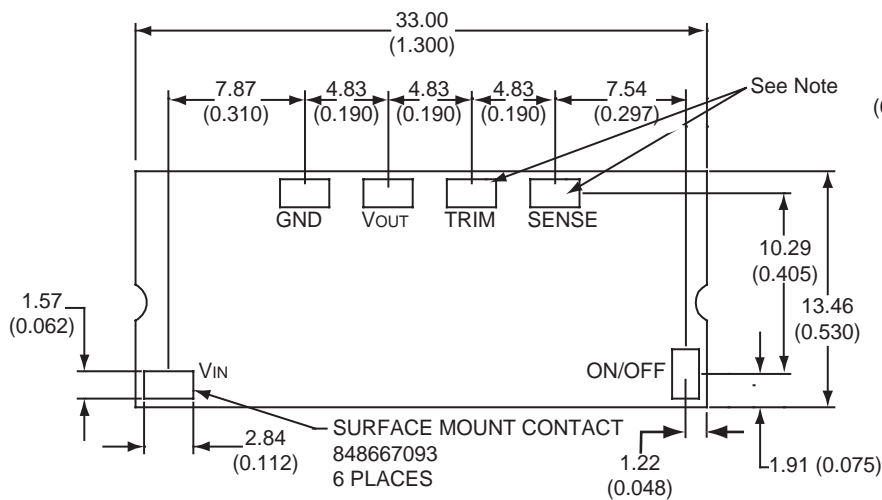

SIDE VIEW

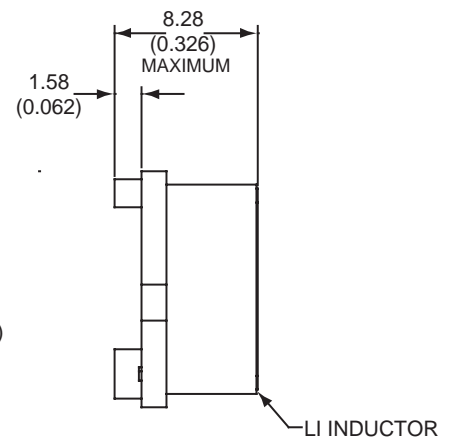

Recommended Pad Layout

Dimensions are in millimeters and (inches).

Tolerances: $x.x \pm 0.5$ mm (0.02 in.), $x.xx \pm 0.25$ mm (0.010 in.), unless otherwise noted.

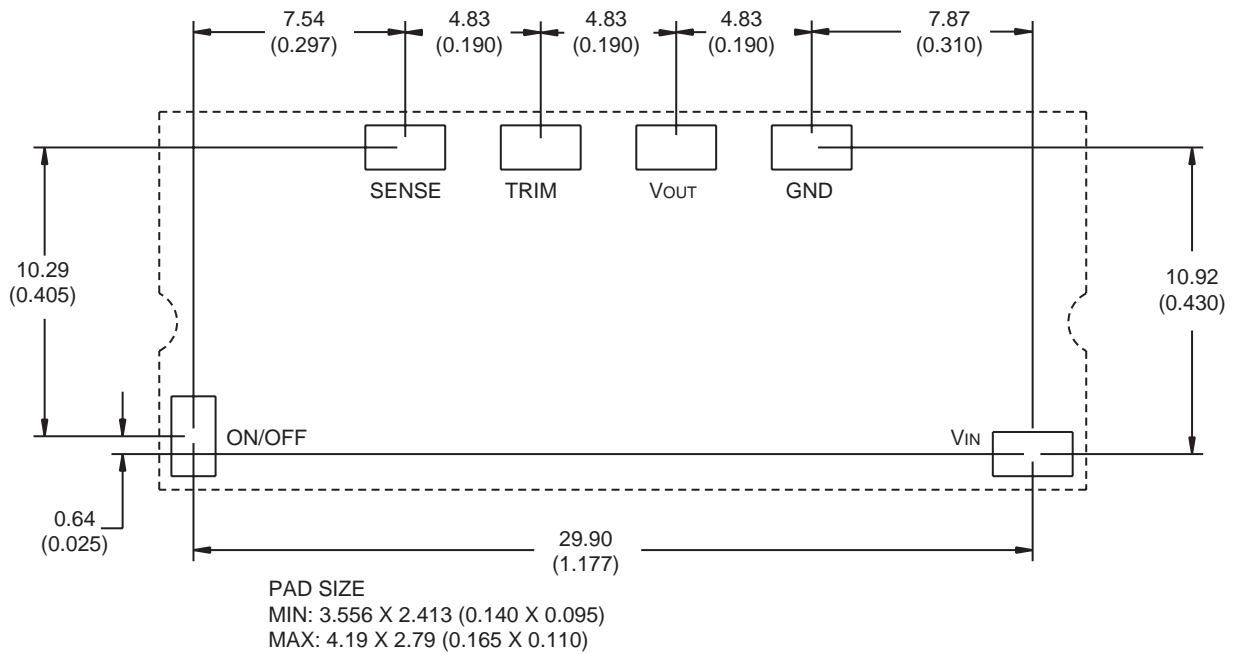

Ordering Information

Please contact your Lineage Power Sales Representative for pricing, availability and optional features.

Table 2. Device Codes without TRIM

Input Voltage	Output Voltage	Output Current	Efficiency	Connector Type	Device Code	Comcodes
3.0 – 5.5 Vdc	0.9 V	10 A	83	SMT	AXH010A0R0S9-SR	108967597
3.0 – 5.5 Vdc	1.0 V	10 A	85	SMT	AXH010A0R1S0-SR	108967605
3.0 – 5.5 Vdc	1.2 V	10 A	86	SMT	AXH010A0P-SR	108967571
3.0 – 5.5 Vdc	1.5 V	10 A	88	SMT	AXH010A0M-SR	108967563
3.0 – 5.5 Vdc	1.8 V	10 A	90	SMT	AXH010A0Y-SR	108967589
3.0 – 5.5 Vdc	2.0 V	10 A	91	SMT	AXH010A0D-SR	108967530
3.0 – 5.5 Vdc	2.5 V	10 A	92	SMT	AXH010A0G-SR	108967555
4.5 – 5.5 Vdc	3.3 V	10 A	95	SMT	AXH010A0F-SR	108967548
3.0 – 5.5 Vdc	1.5 V	10 A	88	SMT	AXH010A0M-SRZ	CC109104915
3.0 – 5.5 Vdc	1.8 V	10 A	90	SMT	AXH010A0Y-SRZ	CC109104956
3.0 – 5.5 Vdc	2.5 V	10 A	92	SMT	AXH010A0G-SRZ	CC109104907
4.5 – 5.5 Vdc	3.3 V	10 A	95	SMT	AXH010A0F-SRZ	CC109106886

Table 3. Device Codes with TRIM

Input Voltage	Output Voltage	Output Current	Efficiency	Connector Type	Device Code	Comcodes
3.0 – 5.5 Vdc	0.9 V	10 A	83	SMT	AXH010A0R0S99-SR	108966177
3.0 – 5.5 Vdc	1.0 V	10 A	85	SMT	AXH010A0R1S09-SR	108966110
3.0 – 5.5 Vdc	1.2 V	10 A	86	SMT	AXH010A0P9-SR	108966144
3.0 – 5.5 Vdc	1.5 V	10 A	88	SMT	AXH010A0M9-SR	108966136
3.0 – 5.5 Vdc	1.8 V	10 A	90	SMT	AXH010A0Y9-SR	108966169
3.0 – 5.5 Vdc	2.0 V	10 A	91	SMT	AXH010A0D9-SR	108966102
3.0 – 5.5 Vdc	2.5 V	10 A	92	SMT	AXH010A0G9-SR	108966128
4.5 – 5.5 Vdc	3.3 V	10 A	95	SMT	AXH010A0F9-SR	108966094
3.0 – 5.5 Vdc	1.2 V	10 A	86	SMT	AXH010A0P9-SRZ	CC109105896
3.0 – 5.5 Vdc	1.5 V	10 A	88	SMT	AXH010A0M9-SRZ	CC109101417
3.0 – 5.5 Vdc	1.8 V	10 A	90	SMT	AXH010A0Y9-SRZ	CC109101425
3.0 – 5.5 Vdc	2.5 V	10 A	92	SMT	AXH010A0G9-SRZ	CC109102935
4.5 – 5.5 Vdc	3.3 V	10 A	95	SMT	AXH010A0F9-SRZ	CC109106878

Ordering Information (continued)

Optional remote sense feature can be ordered using suffix 3 shown in Table 4. For example, a AXH010A0Y-SR with remote sense is AXH010A0Y3-SR

Table 4. Device Options

Option	Suffix
Remote Sense	3
RoHS Compliant	-Z



World Wide Headquarters
Lineage Power Corporation
3000 Skyline Drive, Mesquite, TX 75149, USA
+1-800-526-7819
(Outside U.S.A.: **+1-972-284-2626**)
www.lineagepower.com
e-mail: techsupport1@lineagepower.com

Asia-Pacific Headquarters
Tel: +65 6416 4283

Europe, Middle-East and Africa Headquarters
Tel: +49 89 6089 286

India Headquarters
Tel: +91 80 28411633

Lineage Power reserves the right to make changes to the product(s) or information contained herein without notice. No liability is assumed as a result of their use or application. No rights under any patent accompany the sale of any such product(s) or information.

© 2008 Lineage Power Corporation, (Mesquite, Texas) All International Rights Reserved.