

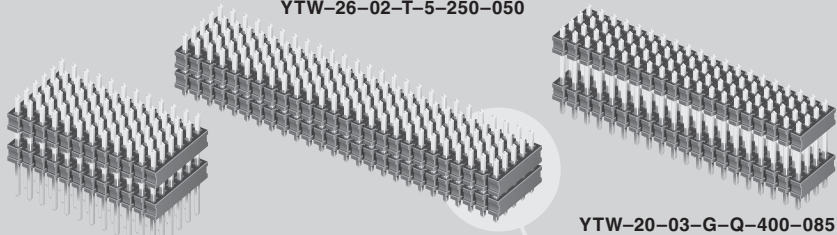

(2,00mm) .0787"

YTW SERIES

YTW-26-02-T-5-250-050



YTW-12-10-S-6-300-215

YTW-20-03-G-Q-400-085

# HIGH DENSITY BOARD STACKER

## SPECIFICATIONS

For complete specifications see [www.samtec.com?YTW](http://www.samtec.com?YTW)

**Insulator Material:**  
Black Liquid Crystal Polymer



**Terminal Material:**  
Phosphor Bronze

**Current Rating:**  
3A @ 80°C ambient

**Operating Temp Range:**  
-55°C to +105°C with Tin;  
-55°C to +125°C with Gold

**Plating:**  
Sn or Au over 50µ" (1,27µm) Ni

**RoHS Compliant:**  
Yes

**Lead-Free Solderable:**  
Wave only.

**Mates with:**  
YTQ, YTS, YTE

## ALSO AVAILABLE

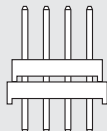

Paste In Hole (PIH) processing.  
Contact Samtec ASP Group.

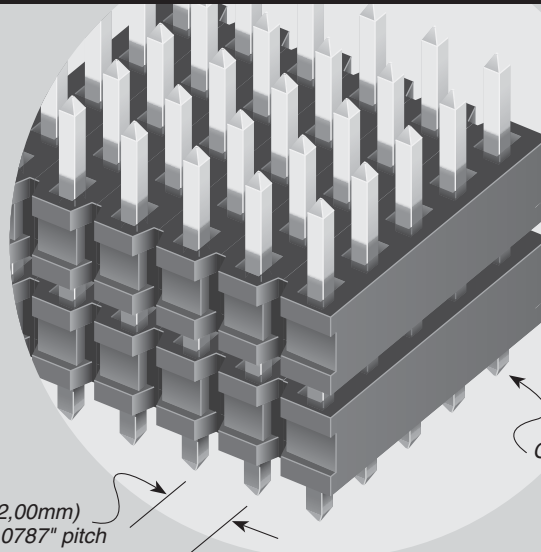

Choice of 4, 5 or 6 row

(2,00mm)  
.0787" pitch

**Note:**  
This Series is non-standard,  
non-returnable.

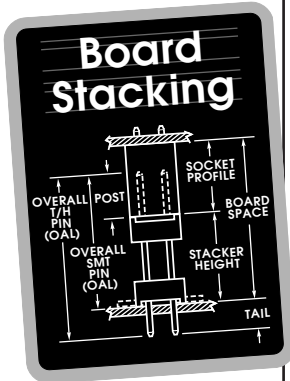

YTW	NO. PINS PER ROW	LEAD STYLE	PLATING OPTION	ROW OPTION	STACKER HEIGHT	TAIL SPEC
	02 thru 50	Specify LEAD STYLE from chart below.	-G = 20µ" (0,51µm) Gold contact area, Gold flash on tail  -S = 30µ" (0,76µm) Gold contact area, Tin on tail (Style -01 & -02 not available)  -L = 10µ" (0,25µm) Gold contact area, Tin on tail  -T = Tin	-Q = Four Row  -5 = Five Row  -6 = Six Row	-"XXX" = Stacker Height In inches (0,13mm) .005" increments  Example: -250 = (6,35mm) .250"	-"XXX" = Tail Length In inches (0,13mm) .005" increments  Example: -150 = (3,81mm) .150"  -"XXX" = Polarized Position

LEAD STYLE	OAL
-01	(8,20) .323
-02	(9,60) .377
-03	(13,60) .535
-04	(14,10) .555
-05	(15,10) .594
-06	(17,10) .673
-07	(19,10) .751
-09	(11,60) .456
-10	(15,60) .614
-11	(10,08) .397

ROW OPTION	STACKER HEIGHT
-Q	(3,05) .120 MIN
-5 & -6	(4,06) .160 MIN

  

## Also Available

**2mm Shunt**  
See 2SN Series.



**Low Profile**  
See YTT & TMM Series.

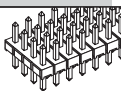

**Right Angle Four Row**  
See TMM Series.

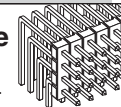

**Shrouded Four Row Vertical & Right Angle**  
See TMMS Series.

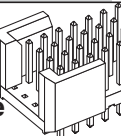

Due to technical progress, all designs, specifications and components are subject to change without notice.

[WWW.SAMTEC.COM](http://WWW.SAMTEC.COM)

SAMTEC USA • Tel: 1-800-SAMTEC-9 or 812-944-6733 SAMTEC SILICON VALLEY • Tel: 408-395-5900 SAMTEC SOUTHERN CALIFORNIA • Tel: 1-800-726-8329  
 SAMTEC AMERICA LATINA COMERCIO EXTERIOR LTDA • Tel: (+55 31) 3786 3227 SAMTEC UNITED KINGDOM • Tel: 44 01236 739292 SAMTEC GERMANY • Tel: +49 (0) 89 / 89460-0  
 SAMTEC FRANCE • Tel: 33 01 60 95 06 60 SAMTEC ITALY • Tel: 39 039 6890337 SAMTEC NORDIC/BALTIC • Tel: +46-84477280 SAMTEC BENELUX • Tel: 44 01236 739292

SAMTEC ISRAEL • Tel: 972-3-7526600 SAMTEC INDIA • Tel: +91-80-3272 1612 SAMTEC ASIA PACIFIC • Tel: 65 6745-5955 SAMTEC JAPAN • Tel: 045-475-1385 SAMTEC CHINA • Tel: 86-21-61103766  
 SAMTEC TAIWAN • Tel: 886-2-2745-6109 SAMTEC HONG KONG • Tel: 852-2690-4658 SAMTEC KOREA • Tel: 82-31-717-5685 SAMTEC ANZ • Tel: 613 9580 0683