

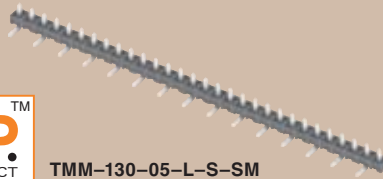

(2,00mm) .0787"

TMM SERIES

TMM-110-01-T-D-SM



TMM-130-05-L-S-SM



TMM-112-01-G-S-SM

LOW PROFILE SMT HEADER

SPECIFICATIONS

For complete specifications and recommended PCB layouts see www.samtec.com?TMM

Insulator Material: Black Liquid Crystal Polymer
Terminal Material: Phosphor Bronze
Plating: Sn or Au over 50µ" (1,27µm) Ni
Operating Temp Range: -55°C to +105°C with Tin; -55°C to +125°C with Gold
Voltage Rating: 500 VAC mated with SQW 450 VAC mated with SQT
RoHS Compliant: Yes



Mates with: CLT, SQT, SQW, ESQT, TLE, SMM, MMS, TCSD, TLSD

ALSO AVAILABLE

Through-Hole

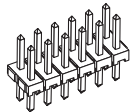

2mm Shunt

Specify **2SN-BK-G** for 2mm shunt with Gold plating.

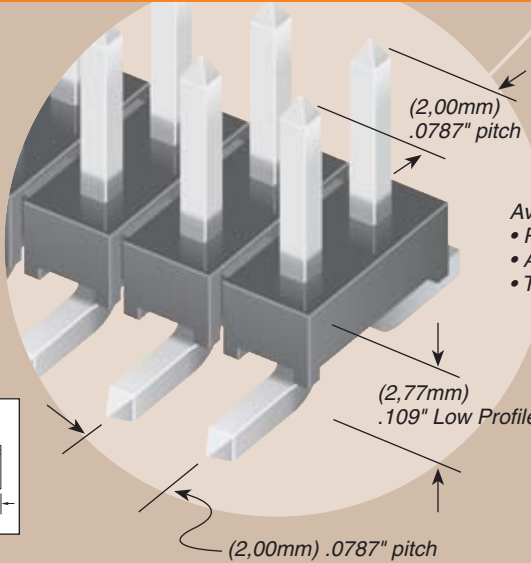
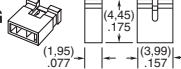

Available with optional
 • Pick & Place Pads
 • Alignment pins
 • Tape & reel packaging

CURRENT RATING	
AMBIENT TEMP	Mated with SMM
20°C	3.9A
40°C	3.5A
60°C	3A
95°C	2A

6 POSITIONS (2x3) POWERED

Processing: Lead-Free Solderable: Yes
SMT Lead Coplanarity: (0,15mm) .006" max

TMM - **1** NO. PINS PER ROW - **LEAD STYLE** - **PLATING OPTION** - **ROW OPTION** - **SM** - **OTHER OPTION**

02 thru 40

Specify **LEAD STYLE** from chart below.

- L** = 10µ" (0,25µm) Gold on post, Matte Tin on tail
- G** = 20µ" (0,51µm) Gold on post, Gold flash on tail
- S** = 30µ" (0,76µm) Gold on post, Matte Tin on tail
- T** = Matte Tin

- S** = Single Row
- D** = Double Row

- A** = Alignment Pin (Metal or plastic at Samtec's discretion) (5 positions minimum) (-D only)
- "XXX"** = Polarized Position (Specify position of omitted pin)
- M** = Metal Pick & Place Pad (4 positions minimum) (-T plating not available) (-D only)
- P** = Pick & Place Pad (3 positions minimum)
- TR** = Tape & Reel Pkg. (3 positions minimum)

LEAD STYLE	A	MATES WITH
-01	(3,20) .126	SQT, SQW, ESQT, TLE, SMM, MMS, TCSD
-04	(1,91) .075	
-05	(1,65) .065	CLT
-06	(4,27) .168	CLT-BE

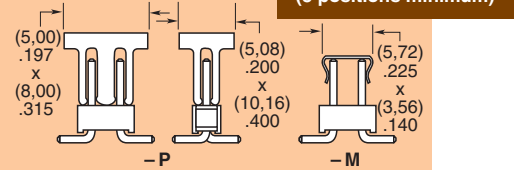
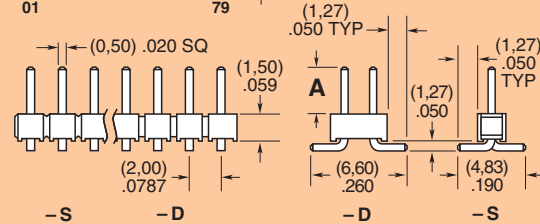
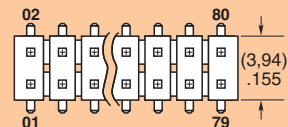
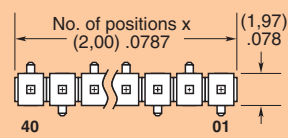

Note: Some lengths, styles and options are non-standard, non-returnable.

Due to technical progress, all designs, specifications and components are subject to change without notice.

WWW.SAMTEC.COM

SAMTEC USA • Tel: 1-800-SAMTEC-9 or 812-944-6733 SAMTEC SILICON VALLEY • Tel: 408-395-5900 SAMTEC SOUTHERN CALIFORNIA • Tel: 1-800-726-8329
 SAMTEC AMERICA LATINA COMERCIO EXTERIOR LTDA • Tel: (+55 31) 3786 3227 SAMTEC UNITED KINGDOM • Tel: 44 01236 739292 SAMTEC GERMANY • Tel: +49 (0) 89 / 89460-0
 SAMTEC FRANCE • Tel: 33 01 60 95 06 60 SAMTEC ITALY • Tel: 39 039 8890337 SAMTEC NORDIC/BALTIC • Tel: +46-84477280 SAMTEC BENELUX • Tel: 44 01236 739292 SAMTEC ISRAEL • Tel: 972-3-7526600
 SAMTEC INDIA • Tel: +91-80-3272 1612 SAMTEC ASIA PACIFIC • Tel: 65 6745-5955 SAMTEC JAPAN • Tel: 045-475-1385 SAMTEC CHINA • Tel: 86-21-61103766 SAMTEC TAIWAN • Tel: 886-2-2735-6109
 SAMTEC HONG KONG • Tel: 852-2600-9858 SAMTEC KOREA • Tel: 82-31-717-5685 SAMTEC ANZ • Tel: 613 9512 7747 SAMTEC SOUTH AFRICA • Tel: 27 11 452 8112