

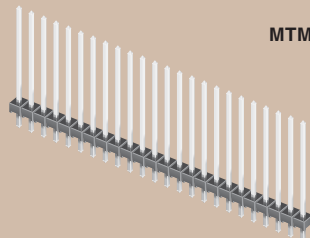

(2,00mm) .0787"

MTMM SERIES



MTMM-114-05-T-Q-225

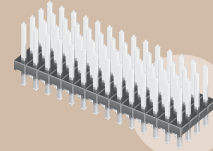

MTMM-124-14-L-S-600

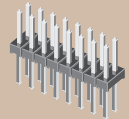

MTMM-108-07-G-D-200

MODIFIED THROUGH-HOLE HEADER

SPECIFICATIONS

For complete specifications see www.samtec.com?MTMM

Insulator Material:
Black Liquid Crystal Polymer



Terminal Material:
Phosphor Bronze

Plating:
Sn or Au over 50µ" (1,27µm) Ni

Current Rating:
3A @ 80°C ambient

Operating Temp Range:
-55°C to +105°C with Tin;
-55°C to +125°C with Gold

RoHS Compliant:
Yes

Lead-Free Solderable:
Yes

Mates with:
CLT, SQT, SQW, ESQT,
TLE, SMM, MMS, TCSD

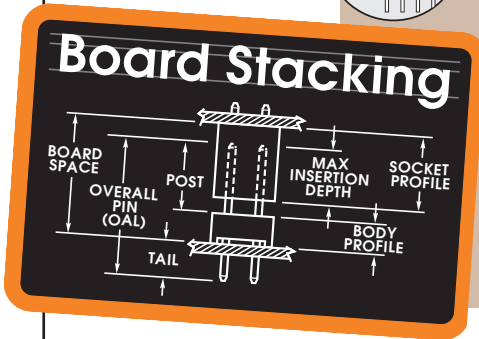

Choice of single, double or quad row

Specify post height in (0,13mm) .005" increments

ALSO AVAILABLE

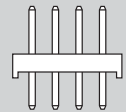

Paste In Hole (PIH) processing. Contact Samtec ASP Group.

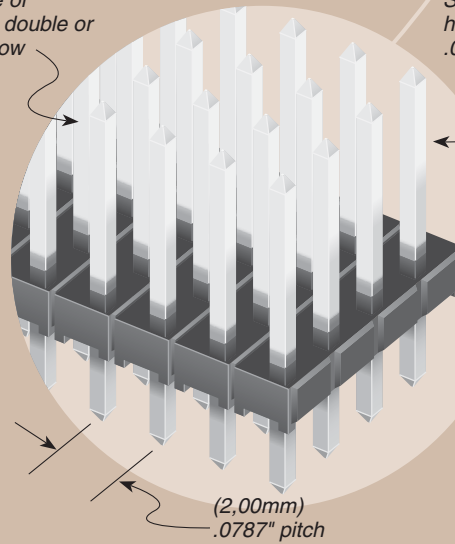

01 thru 50

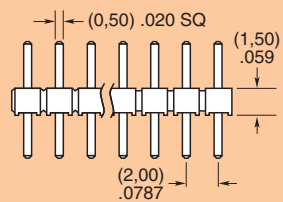
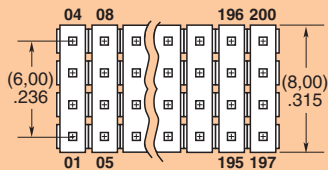
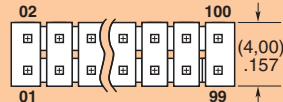
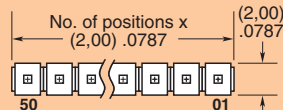

Specify LEAD STYLE from chart.

-L = 10µ" (0,25µm) Gold post, Matte Tin on tail

-G = 20µ" (0,51µm) Gold post, Gold flash on tail

-T = Matte Tin

-S = Single Row

-D = Double Row

-Q = Quad Row

- "XXX" = Post Height in inches (0,13mm) .005" increments

Example: -070 = (1,78mm) .070"

- "XXX" = Polarized Position Specify position of omitted pin

LEAD STYLE	OAL
-02	(6,48) .255
-03	(7,67) .302
-04	(8,20) .323
-05	(9,58) .377
-06	(10,08) .397
-07	(11,58) .456
-08	(12,09) .476
-09	(13,59) .535
-10	(14,10) .555
-11	(15,09) .594
-12	(15,60) .614
-13	(17,09) .673
-14	(19,08) .751
-15	(21,08) .830

Note: Other Gold plating options available. Contact Samtec.

Note: This Series is non-standard, non-returnable.

Due to technical progress, all designs, specifications and components are subject to change without notice.

WWW.SAMTEC.COM

SAMTEC USA • Tel: 1-800-SAMTEC-9 or 812-944-6733 SAMTEC SILICON VALLEY • Tel: 408-395-5900 SAMTEC SOUTHERN CALIFORNIA • Tel: 1-800-726-8329
 SAMTEC AMERICA LATINA COMERCIO EXTERIOR LTDA • Tel: (+55 31) 3786 3227 SAMTEC UNITED KINGDOM • Tel: 44 01236 739292 SAMTEC GERMANY • Tel: +49 (0) 89 / 89460-0
 SAMTEC FRANCE • Tel: 33 01 60 95 06 60 SAMTEC ITALY • Tel: 39 039 6890337 SAMTEC NORDIC/BALTIC • Tel: +46-84477280 SAMTEC BENELUX • Tel: 44 01236 739292 SAMTEC ISRAEL • Tel: 972-3-7526600
 SAMTEC INDIA • Tel: +91-80-3272 1612 SAMTEC ASIA PACIFIC • Tel: 65 6745-5955 SAMTEC JAPAN • Tel: 045-475-1385 SAMTEC CHINA • Tel: 86-21-61103766 SAMTEC TAIWAN • Tel: 886-2-2735-6109
 SAMTEC HONG KONG • Tel: 852-2600-9858 SAMTEC KOREA • Tel: 82-31-717-5685 SAMTEC ANZ • Tel: 613 9512 7747 SAMTEC SOUTH AFRICA • Tel: 27 11 452 8112