

# 3M™ Pak 8 Hermaphroditic Connector

0.8 mm, Vertical, Surface Mount, 11.5 mm Stack Height, Solder Brackets

P08 Series



- 0.8 mm pitch Hermaphroditic Connector System
- Unigender connector functions as both plug and socket
- Surface mount design with solder brackets to increase solder joint integrity
- 11.5 mm stacking height
- High temperature insulator compatible with lead-free assembly
- Polarized alignment posts insure correct assembly and mating
- Available suction tape or molded plug for pick and place operations
- Available tape and reel packaging
- RoHS Compliant. See the Regulatory Information Appendix (RIA) in the “RoHS compliance” section of [www.3M.com/Interconnects](http://www.3M.com/Interconnects) for compliance information (RIA E1 & C1 apply)

Date Modified: September 8, 2009

TS-2096-B  
Sheet 1 of 3

## Physical

### Insulation:

Material: Liquid Crystal Polymer  
Flammability: UL 94V-0  
Color: Natural (off white)

### Contact:

Material: Copper Alloy

### Plating:

Underplating: 50 μ" (1.27 μm) Nickel  
Wiping Area: 8 μ" (0.2 μm) minimum Gold  
Solder Tails: Gold Flash  
Solder Brackets: Sn plated Copper Alloy

## Electrical

**Current Rating:** 0.5 A

**Voltage Rating:** 60 V

**Insulation Resistance:**  $>1 \times 10^6 \Omega$  at 500 V<sub>DC</sub>

**Withstanding Voltage:** 250 V<sub>AC</sub> for 1 minute

## Environmental

**Temperature Rating:** -55°C to +85°C

**Process Rating:** 260°C (per J-Std-020)

# 3M™ Pak 8 Hermaphroditic Connector

0.8 mm, Vertical, Surface Mount, 11.5 mm Stack Height, Solder Brackets

P08 Series

Pos #	A	B	C	D	E	F	G	H
30	18.9	15.3	14.0	18.9	11.2	14.0	11.2	19.5
40	22.9	19.3	18.0	22.9	15.2	18.0	15.2	23.5
50	26.9	23.3	22.0	26.9	19.2	22.0	19.2	27.5
80	39.7	36.1	34.8	39.7	32.0	34.8	32.0	40.3
100	47.7	44.1	42.8	47.7	40.0	42.8	40.0	48.3

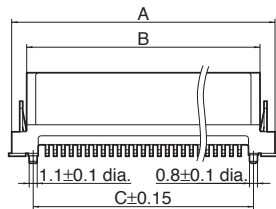
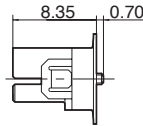
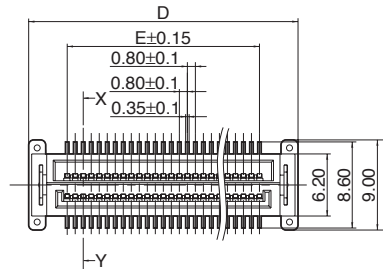

X-Y cross section

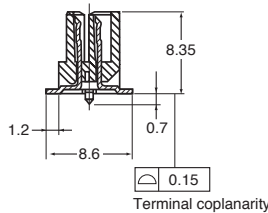

Recommended PC board pattern (TOP VIEW)

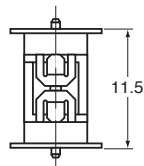
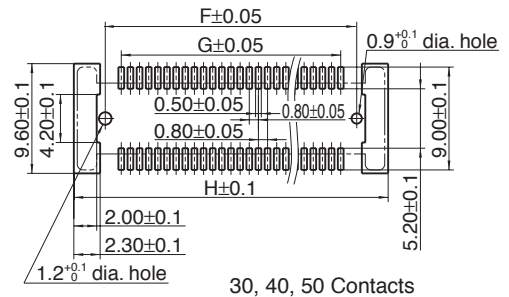

Mated Stack Height

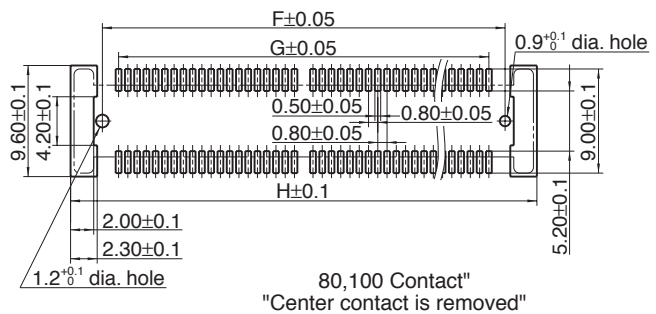

mm  
[inch]

Tolerance Unless Noted		
	.0	.00
mm	±.1	±.10

[ ] Dimensions for Reference Only

## Ordering Information

**P08 - XXX - HLXX - E - G**

Contact Quantity  
(see table)

Hermaphroditic

Locator Posts

C = Adhesive Suction Cover  
M = Molded Suction Cover (Recommended for 260°C Process Temperature)  
Blank = No Cover

T = Tape & Reel Packaging  
Blank = Tube Pack

TS-2096-B  
Sheet 2 of 3

**3M**  
Electronic Solutions Division  
Interconnect Solutions  
<http://www.3M.com/interconnects/>

3M is a trademark of 3M Company.  
For technical, sales or ordering information call  
**800-225-5373**

# 3M™ Pak 8 Hermaphroditic Connector

0.8 mm, Vertical, Surface Mount, 11.5 mm Stack Height, Solder Brackets

P08 Series

## Packaging

### 30, 40, 50, 80 Contact Connectors

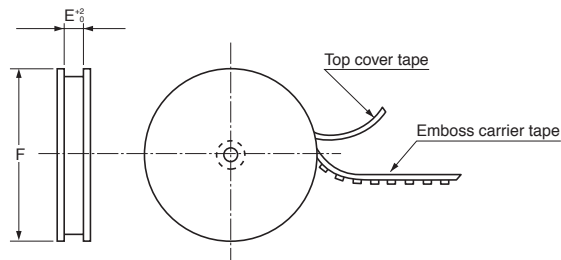
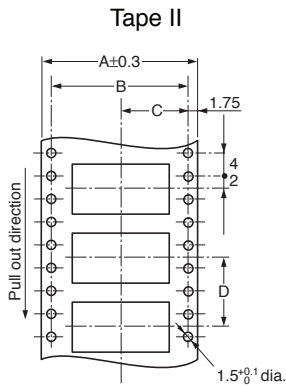

Paper Reel Dimensions Conforming to JIS 0806-1990

### 100 Contact Connector

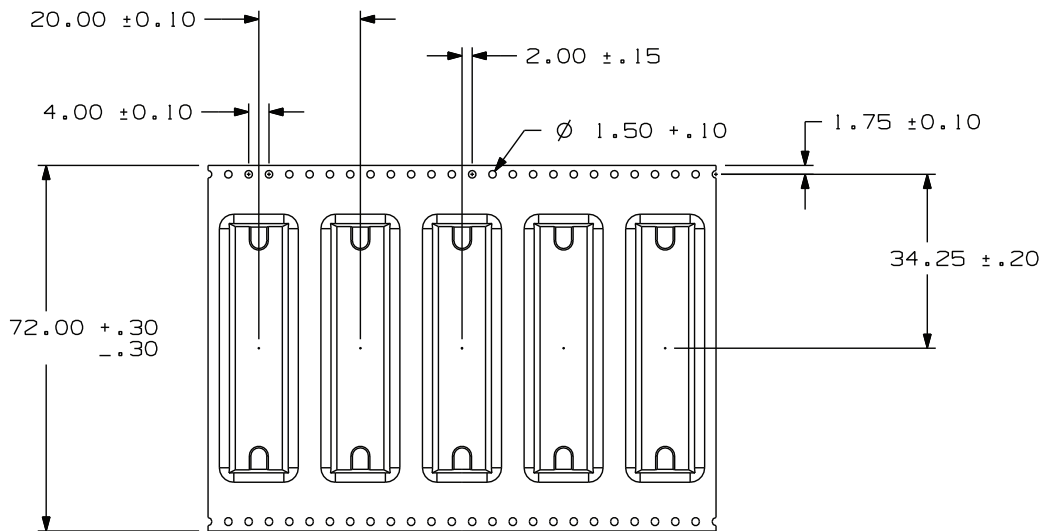

Tape and Reel Dimensions							
	A	B	C	D	E	F	ea/reel
30,40	32	28.4	14.2	24	32.4	370 dia.	350
50	44	40.4	20.2	24	44.4	370 dia.	350
80	56	52.4	26.2	24	56.4	370 dia.	250
100	Contact 3M						

TS-2096-B  
Sheet 3 of 3

### **Important Notice**

All statements, technical information, and recommendations related to 3M's products are based on information believed to be reliable, but the accuracy or completeness is not guaranteed. Before using this product, you must evaluate it and determine if it is suitable for your intended application. You assume all risks and liability associated with such use. Any statements related to the product which are not contained in 3M's current publications, or any contrary statements contained on your purchase order shall have no force or effect unless expressly agreed upon, in writing, by an authorized officer of 3M.

### **Warranty; Limited Remedy; Limited Liability.**

This product will be free from defects in material and manufacture for a period of one (1) year from the time of purchase. **3M MAKES NO OTHER WARRANTIES INCLUDING, BUT NOT LIMITED TO, ANY IMPLIED WARRANTY OF MERCHANTABILITY OR FITNESS FOR A PARTICULAR PURPOSE.** If this product is defective within the warranty period stated above, your exclusive remedy shall be, at 3M's option, to replace or repair the 3M product or refund the purchase price of the 3M product. **Except where prohibited by law, 3M will not be liable for any indirect, special, incidental or consequential loss or damage arising from this 3M product, regardless of the legal theory asserted.**



### **3M Electronics Solutions Division**

6801 River Place Blvd.  
Austin, TX 78726-9000  
U.S.A.  
1-800-225-5373  
[www.3m.com/interconnects](http://www.3m.com/interconnects)

Please recycle. Printed in USA.  
© 3M 2008. All rights reserved.  
RIA-2217B-E

3M is a trademark of 3M Company.