

DFR

D-Sub connectors - Stamped and Formed Contacts

FLAT RIBBON D-SUB CONNECTORS

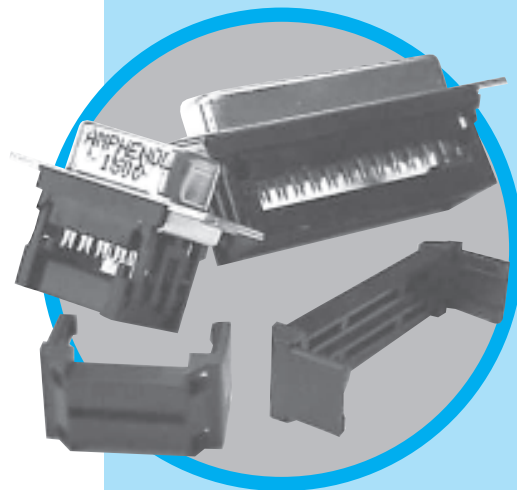

CHARACTERISTICS

Specifications

- Connectors according to MIL C24308

Materials and Platings	
Shells	Steel with nickel plating
Insulator	Glass-filled thermoplastic, UL 94V-0
Pin contacts	Brass, selected gold in mating area; 2.54µm (100µ") min. tin on termination area over 1.27µm (50µ") min. nickel
Socket contact	Phosphor bronze, selected gold in mating area; 2.54µm (100µ") min. tin on termination area over 1.27µm (50µ") min. nickel
Rear insert	Brass, 2.54µm (100µ") min. nickel plated
Screwlock	Brass, 2.54µm (100µ") min. nickel plated

Electrical Data	
Current rating	5A
Voltage rating	250V AC/rms 60Hz
Withstanding voltage	1000V AC/rms 60Hz for one minute
Insulation resistance	1000MΩ
Contact resistance	20mΩ max

Climatic Data	
Operating temperature	-40°C to +125°C

Mechanical Data		
Single contact insertion force	0.54kg (1.19lb) max	
Single contact withdrawal force	0.06kg (0.13lb) min	
Mating and unmating force		
Unit: kg (lb)		
No. of Cts	Mate (max)	Unmate (min)
9 (size E)	3.05 (6.74)	0.36 (0.79)
15 (size A)	5.09 (11.24)	0.46 (1.01)
25 (size B)	8.44 (18.66)	0.81 (1.8)
37 (size C)	12.51 (27.65)	1.1 (2.47)
Standard plating thicknesses		
• gold flash		
• 0.4µm (15µ") gold		
• 0.76 µm (30µ") gold		

DESCRIPTION

These connectors are suitable for compact requirement of modern peripheral equipment.

Special contact design allows usage of standard 1.27mm (.05") flat cable. Suitable with all standard D-Sub hoods.

APPLICATIONS

- Industrial
- Telecom
- Any industry standard I/O connections

*Simplify
Your cable
assemblies!*

DFR / E12



Amphenol

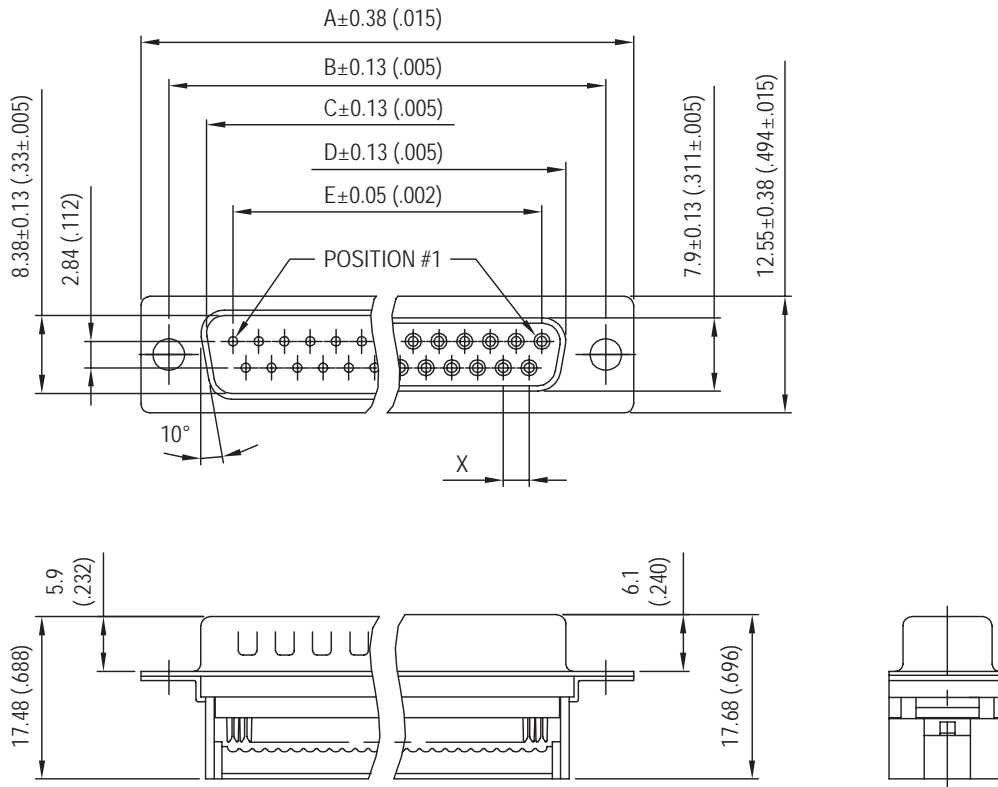

Nb OF CONTACTS	DIMENSIONS mm (inch)					
	A	B	C	D	E	X
9	30.84 (1.21)	24.99 (.984)	16.92 (.666)	16.24 (.639)	11.09 (.437)	2.74
15	39.24 (1.54)	33.32 (1.31)	24.70 (.972)	24.56 (.967)	19.39 (.763)	2.74
25	53.04 (2.09)	47.04 (1.85)	38.96 (1.53)	38.38 (1.51)	33.24 (1.31)	2.77
37	69.32 (2.73)	63.50 (2.50)	55.42 (2.18)	54.76 (2.16)	49.86 (1.96)	2.77

STRAIN RELIEF

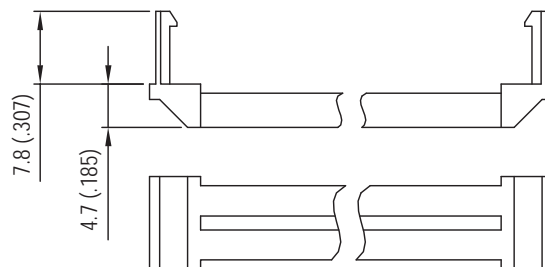

Panel mounting option

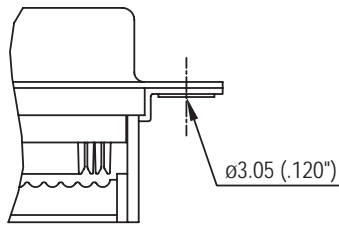

Standard rivet \varnothing 3.05mm
no digit

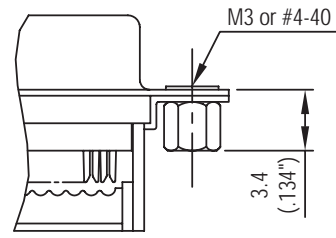

Threaded rear insert
B / D

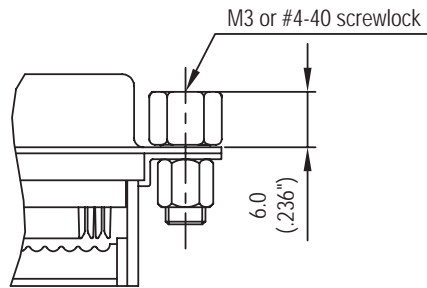

Front female screwlock
A / C

Tool

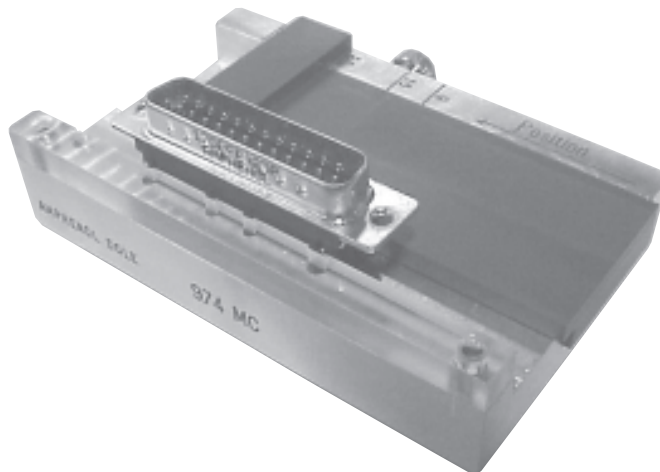

Support for hand termination tool:
974MC

How to order

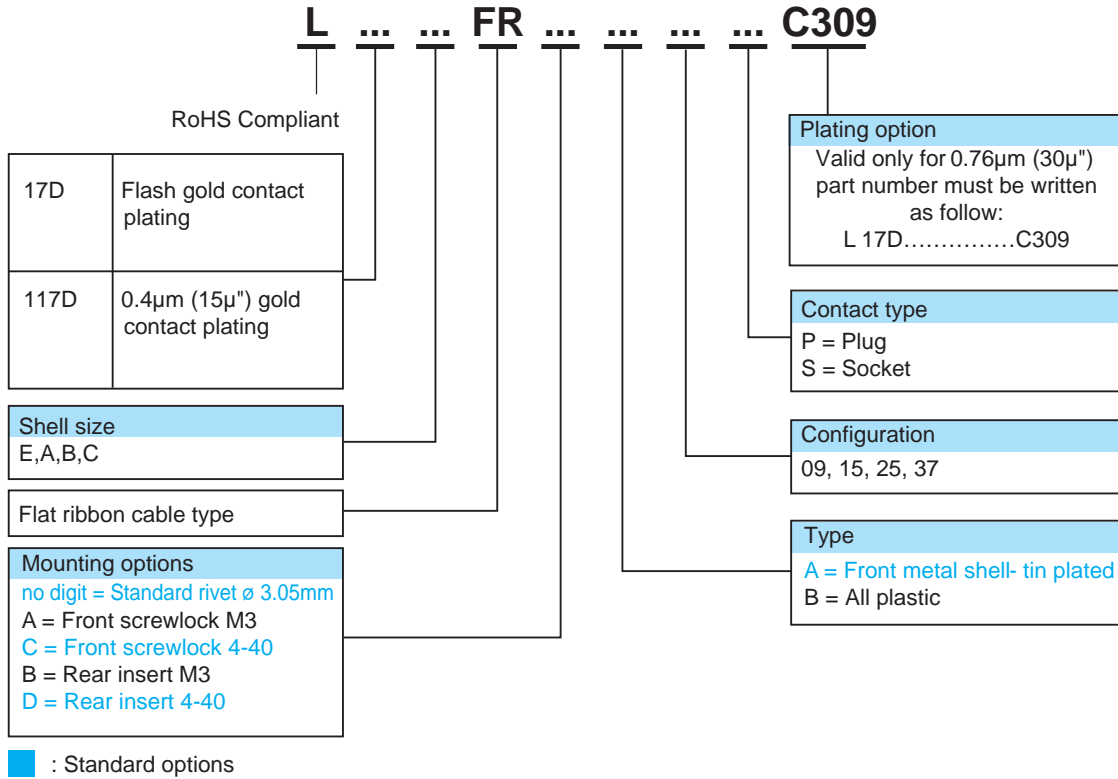

Do not hesitate to contact us for further information

Amphenol

Amphenol IT & Communication Products

Block A3/A4, The 4th Industrial District of
 Industrial Headquarters, Dong Keng Road
 Gong Ming Town, Shen Zhen China
 Fax: +86(0)755 2754 9955

Technical Support

Tel: +86(0)755 2717 7945
 Info-dsub@amphenol.com.cn
<http://www.dsubconnector.com>