

**MICTOR SB Interconnection System (Continued)**

**0.50 [.020] Centerline  
30.00 [1.181] Stack Height  
Plugs**

**Note:** Parts are available with vacuum dots for robotic placement.

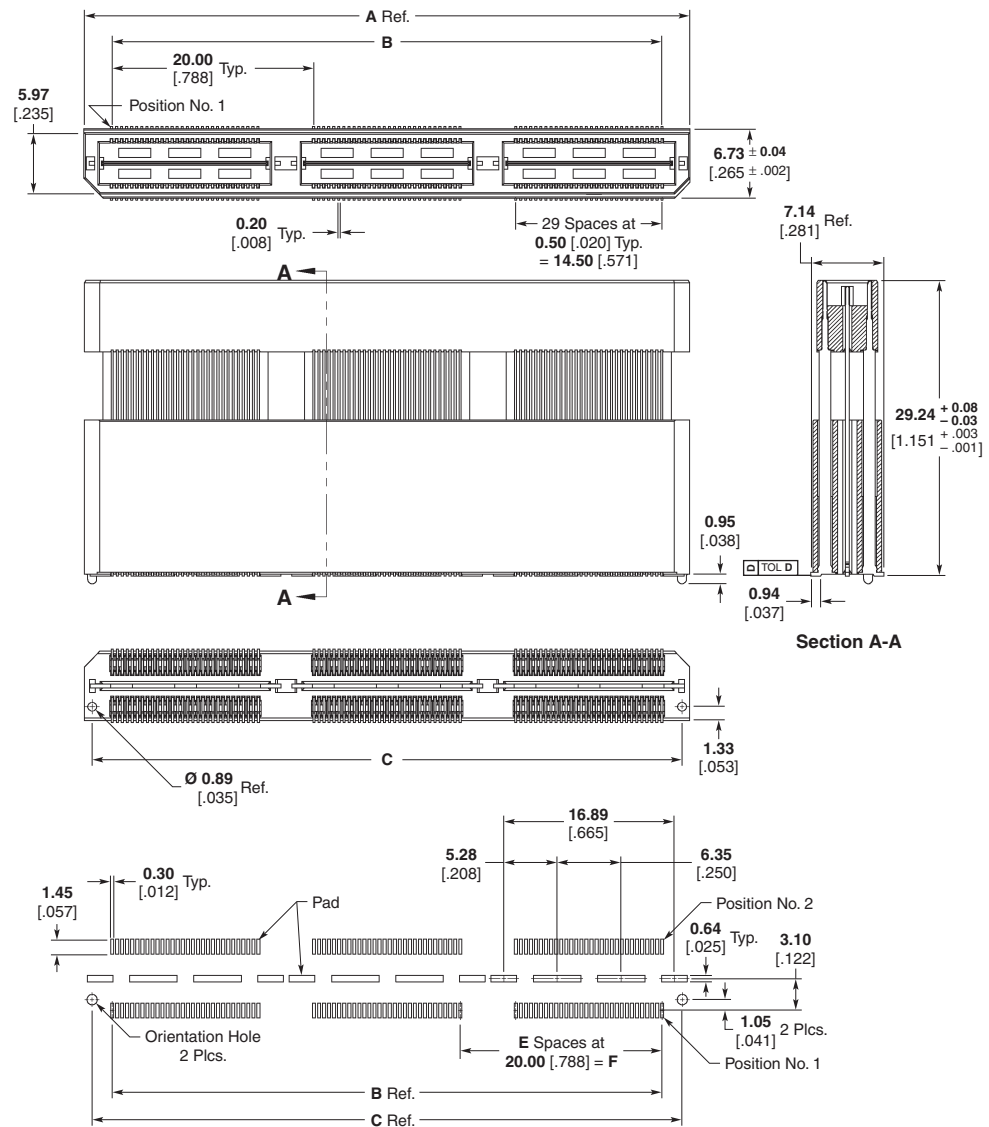



**Recommended PC Board Layout  
(Viewed from Connector Side)**

Packaging Type	No. of Positions	Dimensions						Gold Flash Plating		10 µ Gold Plating	
		A	B	C	D	E	F	Vacuum Dots Without	Vacuum Dots With	Vacuum Dots Without	Vacuum Dots With
Tray	60	20.02 .788	14.50 .571	18.49 .728	0.10 .004	0	0.00 .000	1658061-1	—	1658030-1	—
	120	40.01 1.575	34.51 1.359	38.48 1.515	0.10 .004	1	20.00 .788	1658061-2	—	1658030-2	—
	180	60.02 2.363	54.51 2.146	58.50 2.303	0.10 .004	2	40.00 1.575	1658061-3	—	1658030-3	—
	240	80.01 3.150	74.51 2.934	78.49 3.090	0.15 .006	3	60.01 2.362	1658061-4	—	1658030-4	—
	300	100.03 3.938	94.51 3.721	98.50 3.878	0.15 .006	4	80.01 3.150	1658061-5	—	1658030-5	—

**Note:** All part numbers are RoHS compliant.

## Introduction to the Micro-Strip Interconnection System (1.27 x 2.54 [.050 x .100] Centerline)

### Product Facts

- Designed for high speed applications
- Provides controlled impedance
- Low inductance
- High density
- Superior electrical performance down to 100 picosecond rise times
- 40 high speed signal lines per inch
- Daughtercard-to-motherboard stacking connectors available in sizes of 40 to 240 positions
- Custom stacking heights available: between 10.92 [.430] and 18.75 [.738] or 31.12 [1.225] and 38.94 [1.533]
- Cable-to-board system available in sizes of 40 to 120 positions
- Vertical and right-angle board mount receptacles for cable connectors
- Connector housings are polarized
- Recognized under the Component Program of Underwriters Laboratories Inc., File No. E28476 
- Certified by Canadian Standards Association, File No. LR 7189 

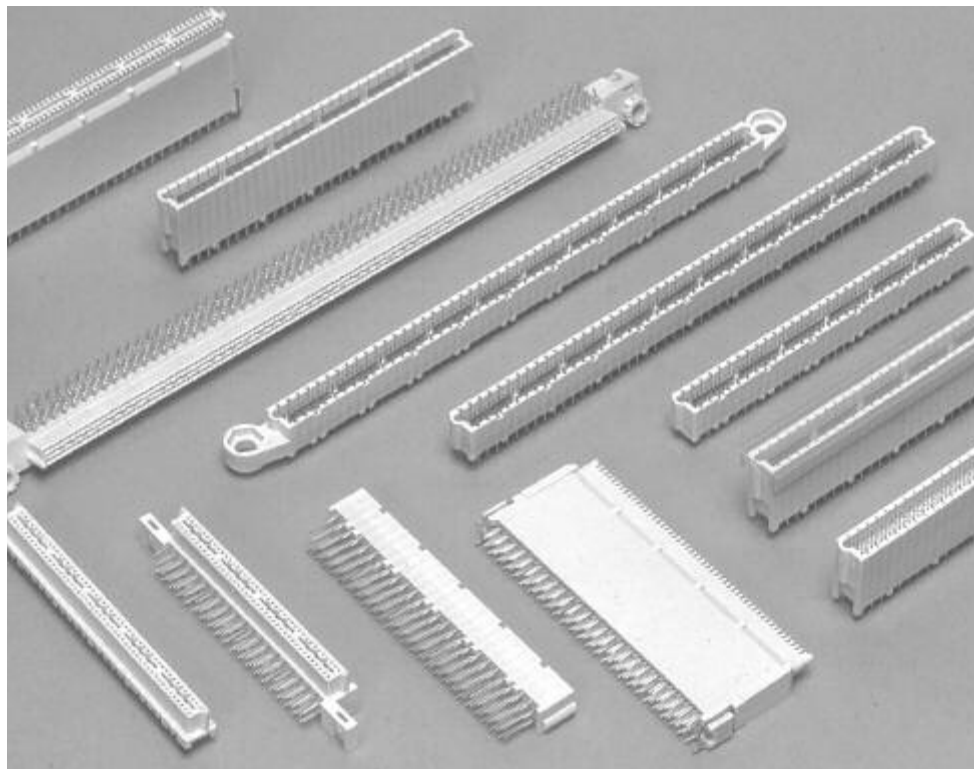

Tyco Electronics Micro-Strip connectors are a high density, controlled impedance connector family compatible with the requirements of high density and high speed data transmission technologies.

Each signal line within the mated connector is located at a specific distance from an integral, separable bus bar serving as a ground plane in a micro-strip configuration. The selection of housing dielectric, spacing from signal contact-to-ground plane and conductor geometry provide a specific charac-

teristic impedance plus very low inductance and capacitance.

Discontinuities resulting from connector structure and solder interfaces are dimensionally small and therefore appear transparent to high speed signals. Both vertical and right-angle board-to-board and cable-to-board connector versions share a nominal impedance of 50 ohms (single ended) or 100 ohms (differential pair).

Each one inch length of connector houses two electrically isolated high current contacts. When soldered to

the PC board ground plane, that ground plane is extended through the mated connector.

Resistance is minimized by a large contact area and short electrical length, providing signal return paths with negligible ground loop voltages. Since signal return is via the bus bars, signal-ground-signal alternation, common to high speed applications, becomes unnecessary. All contacts can be dedicated to signal transmission, effectively doubling connector density.

## Introduction to the Micro-Strip Interconnection System (1.27 x 2.54 [.050 x .100] Centerline) (Continued)

### Performance Characteristics

**Connector Impedance** —  
50 ohms  $\pm 10\%$  at 1 ns

**Configuration** — 2.54 [.100]  
signal row-to-signal row,  
1.27 [.050] signal-to-ground,  
1.27 [.050] signal-to-signal

### Vertical Board-to-Board Stacking Applications

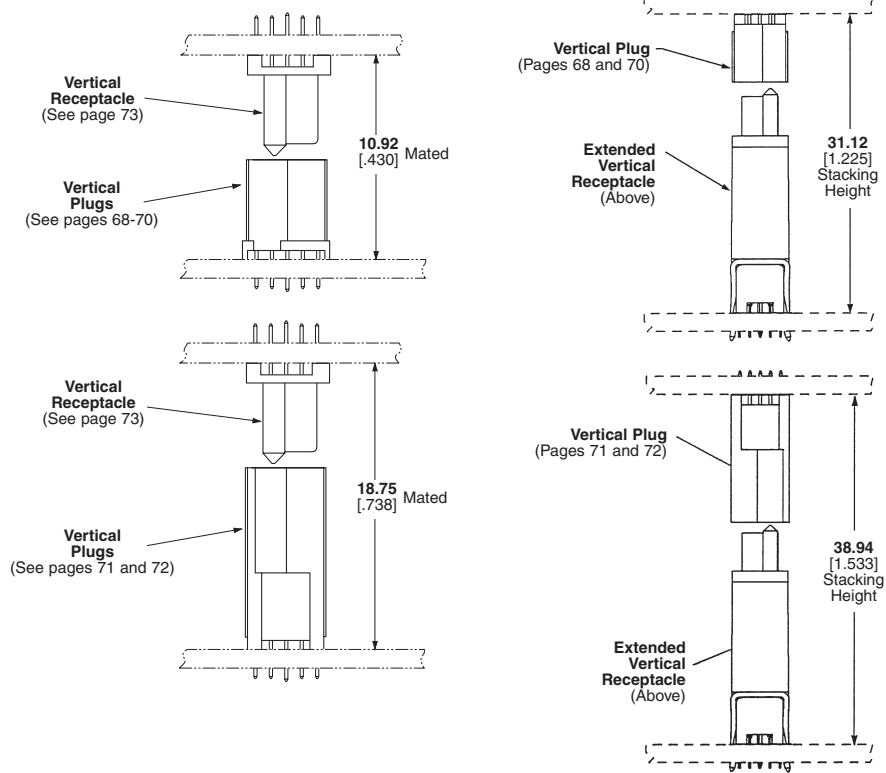

### Right-Angle Board-to-Board Application\* (Small Paddlecard Applications)

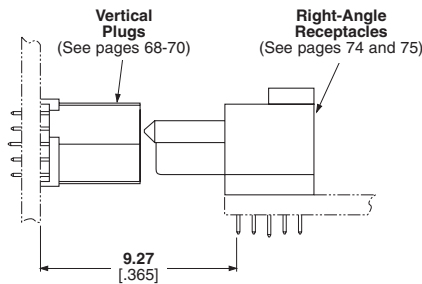

\* Not recommended for use as a daughtercard/backplane interconnector.

### Vertical and Right-Angle Cable-to-Board Applications (Ref. Tyco Electronics Catalog 65069, Micro-Strip Cable Assemblies)

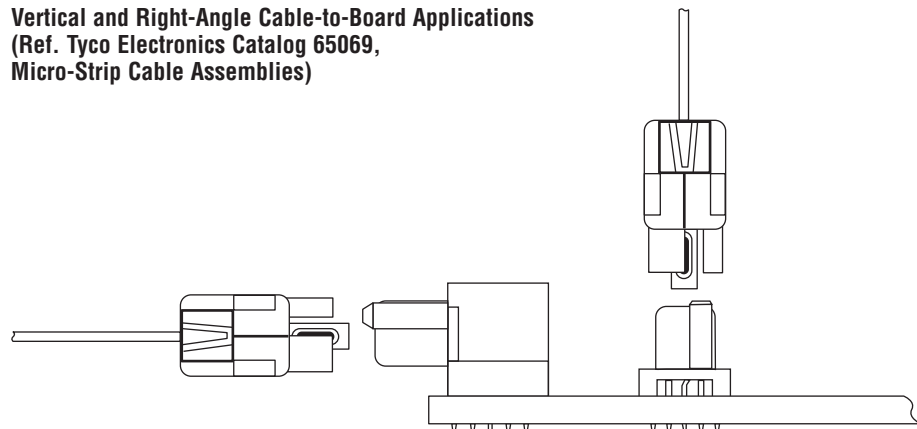

## Micro-Strip Vertical Plugs with Guides (Board-to-Board)

### 10.92 [.430] Stacking Height

#### Material and Finish

**Housing** — High-temperature thermo-plastic, flame retardant, natural color

**Bus Bar** — Phosphor bronze; duplex plated 0.00076 [.000030] gold in mating area, 0.00254 [.000100] tin-lead in terminating area, with entire bus underplated 0.00127 [.000050] nickel

**Signal Pin** — Phosphor bronze; duplex plated 0.00076 [.000030] gold in mating area, 0.00254 [.000100] tin-lead in terminating area, with entire contact underplated 0.00127 [.000050] nickel

#### Related Product Data

**Performance Characteristics** — page 67

**Mating Receptacles** — pages 73, 74 and 76

**Technical Documents** — page 81

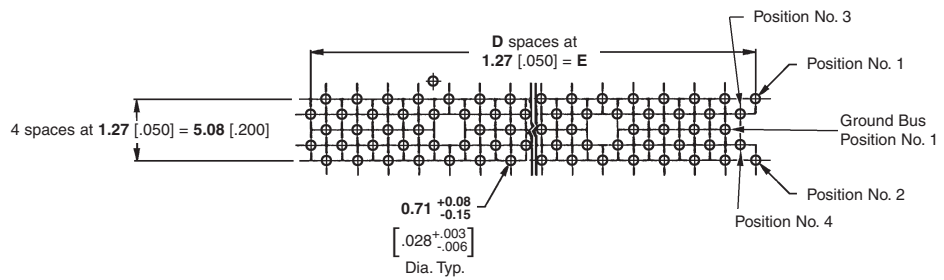
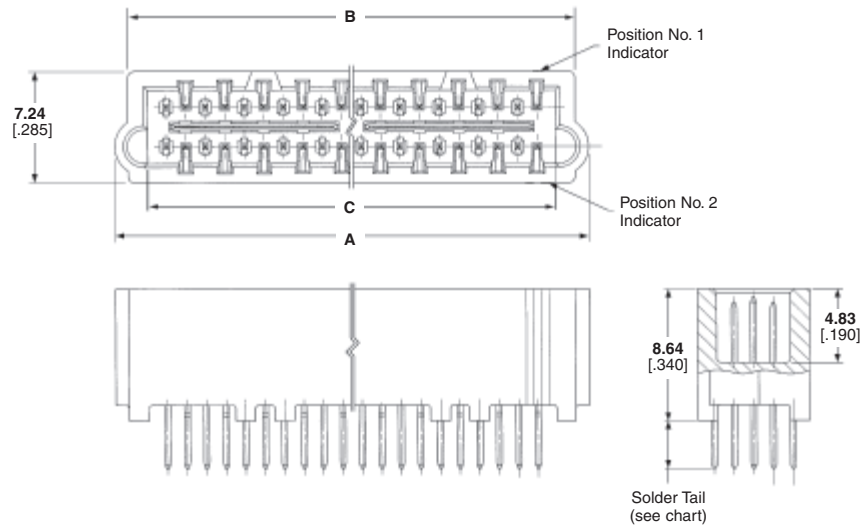

Recommended PC Board Layout

No. of Positions	Dimensions					Part Numbers	
	A	B	C	D	E	2.41 [.095] Solder Tail	3.18 [.125] Solder Tail
40	30.84 1.214	29.08 1.145	26.62 1.048	19	24.13 .950	536280-1◆	536272-1◆
60	43.54 1.714	41.78 1.645	39.32 1.548	29	36.83 1.450	536280-2◆	536272-2◆
80	56.24 2.214	54.48 2.145	52.02 2.048	39	49.53 1.950	536280-3◆	536272-3◆
100	68.94 2.714	67.18 2.645	64.72 2.548	49	62.23 2.450	536280-4◆	536272-4◆
120	81.64 3.214	79.88 3.145	77.42 3.048	59	74.93 2.950	536280-5◆	536272-5◆
140	94.34 3.714	92.58 3.645	90.12 3.548	69	87.63 3.450	536280-6◆	536272-6◆
160	107.04 4.214	105.28 4.145	102.82 4.048	79	100.33 3.950	536280-7◆	536272-7◆
180	119.74 4.714	117.98 4.645	115.52 4.548	89	113.03 4.450	536280-8◆	536272-8◆
200	132.44 5.214	130.68 5.145	128.22 5.048	99	125.73 4.950	536280-9◆	536272-9◆

**Note:** Part Numbers are RoHS compliant except: ◆ Indicates non-RoHS compliant;  
● Indicates "5 of 6 compliant" (lead in solderable interface only).

**Micro-Strip Vertical Plugs with Guides (Board-to-Board) (Continued)**

**10.92 [.430]  
Stacking Height**

**Material and Finish**

**Housing** — High-temperature thermo-plastic, flame retardant, natural color

**Bus Bar** — Phosphor bronze; duplex plated 0.00076 [.000030] gold in mating area, 0.00254 [.000100] tin-lead in terminating area, with entire bus underplated 0.00127 [.000050] nickel

**Signal Pin** — Phosphor bronze; duplex plated 0.00076 [.000030] gold in mating area, 0.00254 [.000100] tin-lead in terminating area, with entire contact underplated 0.00127 [.000050] nickel

**Related Product Data**

**Performance Characteristics** — page 67

**Mating Receptacles** — page 75

**Technical Documents** — page 81

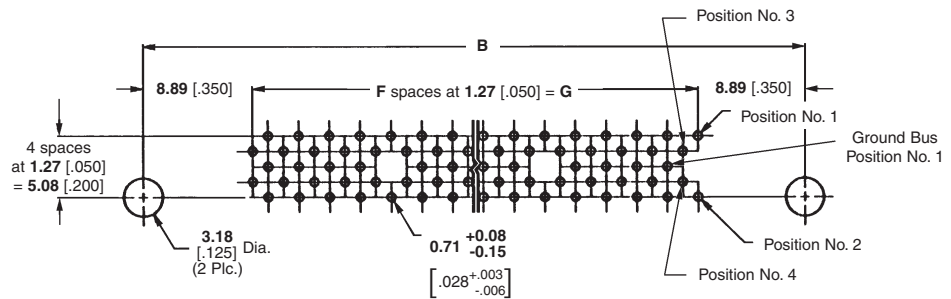
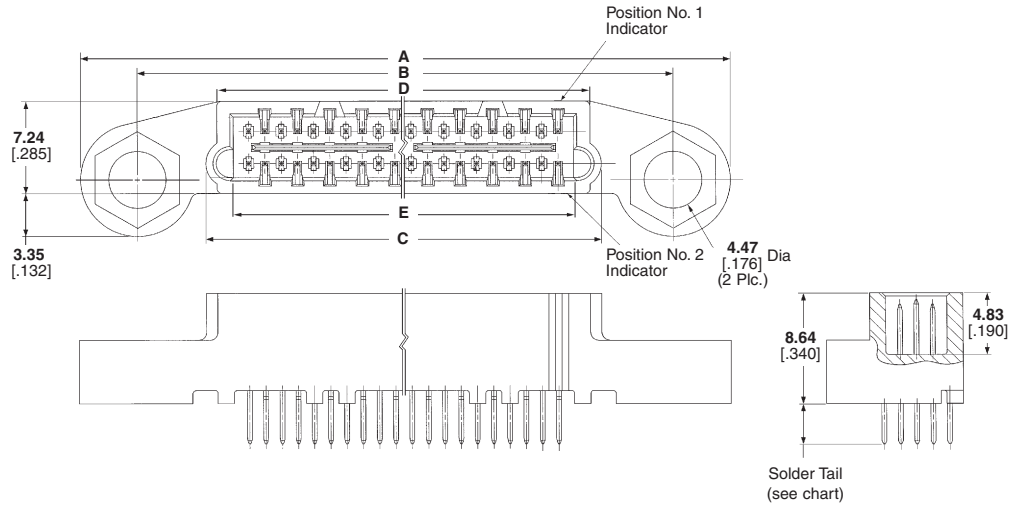

**Recommended PC Board Layout**

**Note:** Guide Pins must be purchased separately; order Part Number 536304-2.

No. of Positions	Dimensions							Part Number
	A	B	C	D	E	F	G	
140	114.30 4.500	105.41 4.150	94.34 3.714	92.58 3.645	90.12 3.548	69	87.63 3.450	536303-1●
160	127.00 5.000	118.11 4.650	107.04 4.214	105.28 4.145	102.82 4.048	79	100.33 3.950	536303-2●
200	152.40 6.000	143.51 5.560	132.44 5.214	130.68 5.145	128.22 5.048	99	125.73 4.950	536303-4●

**Note:** Part Numbers are RoHS compliant except: ● Indicates non-RoHS compliant; ● Indicates "5 of 6 compliant" (lead in solderable interface only).

**Micro-Strip Vertical Plugs with ACTION PIN Contacts  
(Board-to-Board)**

**10.92 [.430]  
Stacking Height**

**Material and Finish**

**Housing** — High-temperature thermo-plastic, flame retardant, natural color

**Bus Bar** — Phosphor bronze; duplex plated 0.00076 [.000030] gold in mating area, 0.00254 [.000100] tin-lead in terminating area, with entire bus underplated 0.00127 [.000050] nickel

**Signal Pin** — Phosphor bronze; duplex plated 0.00076 [.000030] gold in mating area, 0.00254 [.000100] tin-lead in terminating area, with entire contact underplated 0.00127 [.000050] nickel

**Related Product Data**

**Performance Characteristics** — page 67

**Mating Receptacles** — pages 73, 74 and 76

**ACTION PIN Contacts** — pages 78 and 79

**Application Tooling** — pages 80

**Technical Documents** — page 81

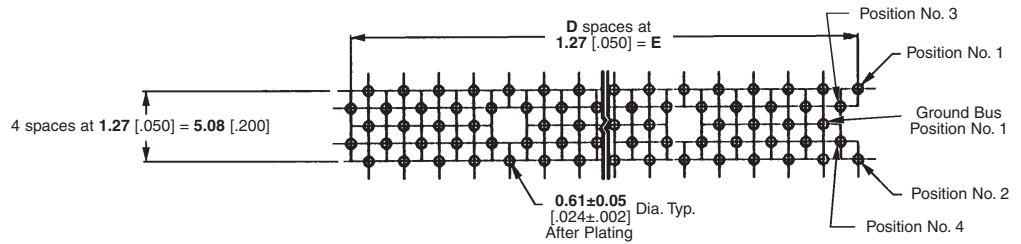
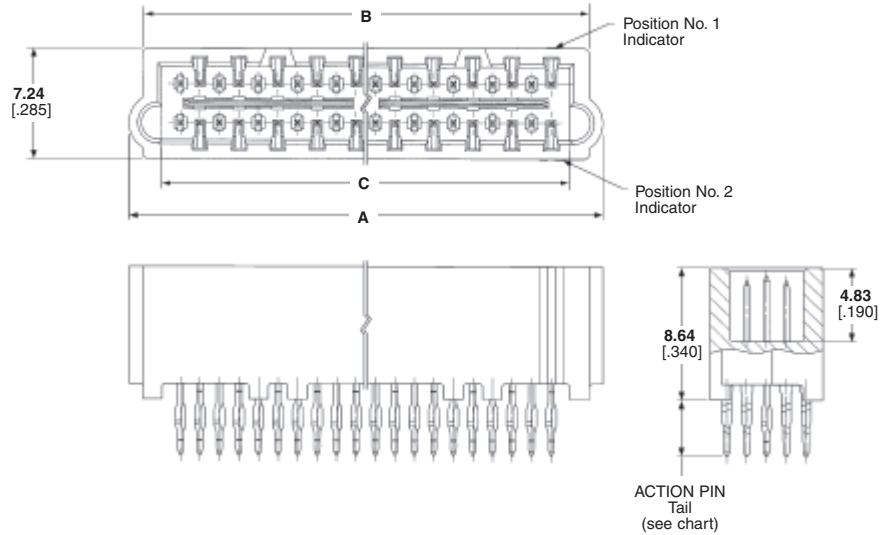

**Recommended PC Board Layout  
(Connector Side of Board Shown)**

No. of Positions	Dimensions					Part Numbers
	A	B	C	D	E	3.68 [.145] ACTION PIN Tail
40	30.84 1.214	29.08 1.145	26.62 1.048	19	24.13 .950	536274-1●
80	56.24 2.214	54.48 2.145	52.02 2.048	39	49.53 1.950	536274-3●
100	68.94 2.714	67.18 2.645	64.72 2.548	49	62.23 2.450	536274-4●
120	81.64 3.214	79.88 3.145	77.42 3.048	59	74.93 2.950	536274-5●
140	94.34 3.714	92.58 3.645	90.12 3.548	69	87.63 3.450	536274-6●
160	107.04 4.214	105.28 4.145	102.82 4.048	79	100.33 3.950	536274-7●
180	119.74 4.714	117.98 4.645	115.52 4.548	89	113.03 4.450	536274-8●

**Note:** Refer to page 78 for information on ACTION PIN.

**Note:** Part Numbers are RoHS compliant except: ♦ Indicates non-RoHS compliant;  
● Indicates "5 of 6 compliant" (lead in solderable interface only).



## Micro-Strip Vertical Plugs (Board-to-Board)

### 18.75 [.738] Stacking Height

#### Material and Finish

**Housing** — High-temperature thermo-plastic, flame retardant, natural color

**Bus Bar** — Phosphor bronze; duplex plated 0.00076 [.000030] gold in mating area, 0.00254 [.000100] tin-lead in terminating area, with entire bus underplated 0.00127 [.000050] nickel

**Signal Pin** — Phosphor bronze; duplex plated 0.00076 [.000030] gold in mating area, 0.00254 [.000100] tin-lead in terminating area, with entire contact underplated 0.00127 [.000050] nickel

#### Related Product Data

**Performance Characteristics** — page 67

**Mating Receptacles** — pages 73, 74 and 76

**Technical Documents** — page 81

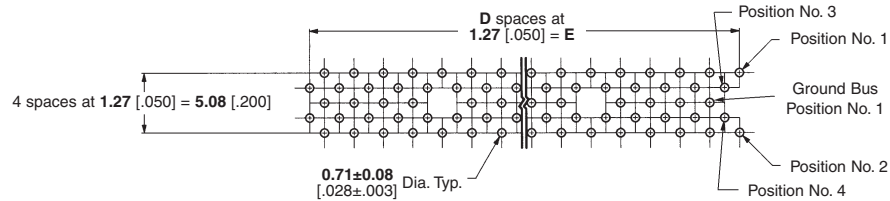
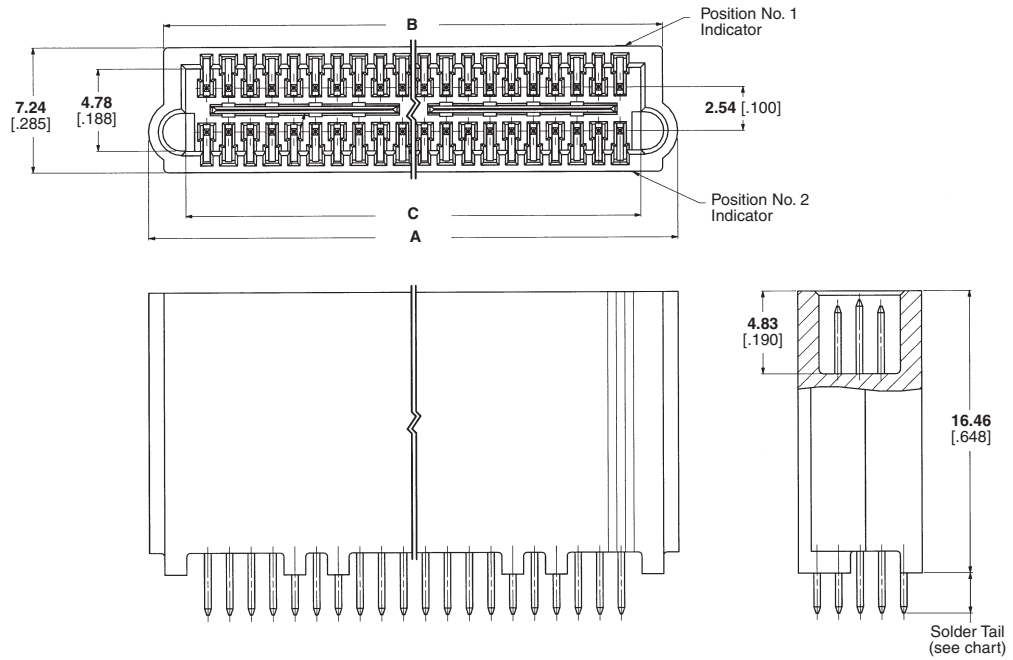

Recommended PC Board Layout  
(Component Side of Board)

No. of Positions	Dimensions					Part Numbers		
	A	B	C	D	E	2.41 [.095] Solder Tail	3.18 [.125] Solder Tail	4.70 [.185] Solder Tail
40	30.84 1.214	29.21 1.150	26.62 1.048	19	24.13 .950	149009-1●	149011-1●	149012-1●
60	43.54 1.714	41.91 1.650	39.32 1.548	29	36.83 1.450	149009-2●	149011-2●	149012-2●
80	56.24 2.214	54.61 2.150	52.02 2.048	39	49.53 1.950	149009-3●	149011-3●	149012-3●
100	68.94 2.714	67.31 2.650	64.72 2.548	49	62.23 2.450	149009-4●	149011-4●	—
120	81.64 3.214	80.01 3.150	77.42 3.048	59	74.93 2.950	149009-5●	149011-5●	—
140	94.34 3.714	92.71 3.650	90.12 3.548	69	87.63 3.450	149009-6●	149011-6●	—
160	107.04 4.214	105.41 4.150	102.82 4.048	79	100.33 3.950	149009-7●	149011-7●	—
180	119.74 4.714	118.11 4.650	115.52 4.548	89	113.03 4.450	149009-8●	149011-8●	—
200	132.44 5.214	130.81 5.150	128.22 5.048	99	125.73 4.950	149009-9●	149011-9●	—

**Note:** Part Numbers are RoHS compliant except: ● Indicates non-RoHS compliant;  
● Indicates "5 of 6 compliant" (lead in solderable interface only).

**Micro-Strip Vertical Plugs with ACTION PIN Contacts (Board-to-Board)**

**18.75 [.738]  
Stacking Height**

**Material and Finish**

**Housing** — High-temperature thermo-plastic, flame retardant, natural color

**Bus Bar** — Phosphor bronze; duplex plated 0.00076 [.000030] gold in mating area, 0.00254 [.000100] tin-lead in terminating area, with entire bus underplated 0.00127 [.000050] nickel

**Signal Pin** — Phosphor bronze; duplex plated 0.00076 [.000030] gold in mating area, 0.00254 [.000100] tin-lead in terminating area, with entire contact underplated 0.00127 [.000050] nickel

**Related Product Data**

**Performance Characteristics** — page 67

**Mating Receptacles** — pages 73, 74 and 76

**ACTION PIN Contacts** — pages 78 and 79

**Application Tooling** — pages 80

**Technical Documents** — page 81

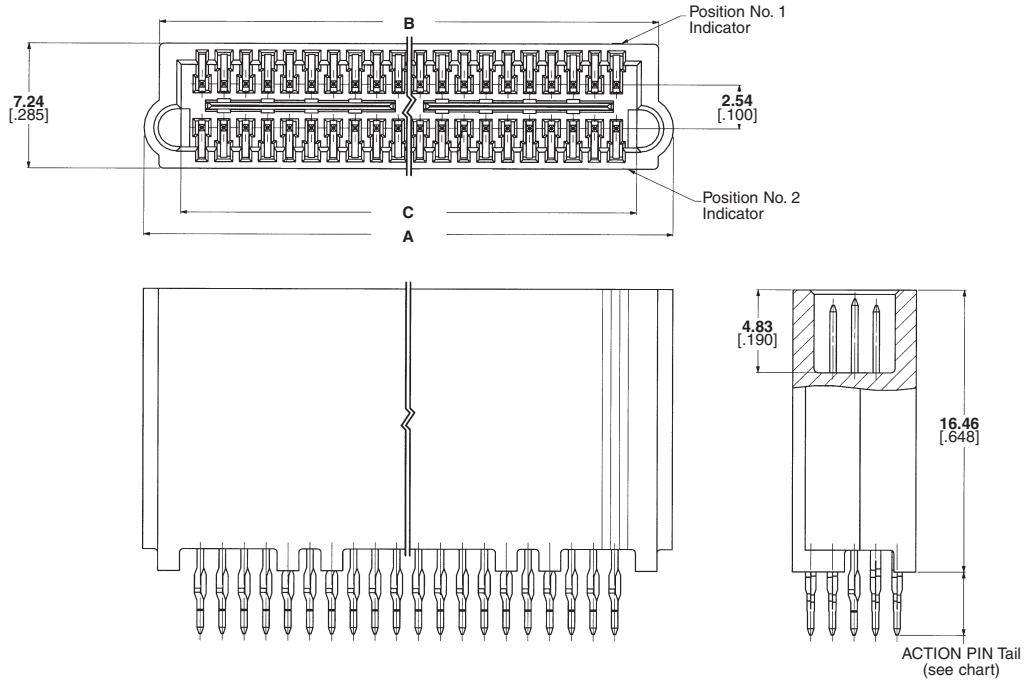

**Recommended PC Board Layout  
(Connector Side of Board Shown)**

No. of Positions	Dimensions					Part Numbers	
	A	B	C	D	E	3.68 [.145] ACTION PIN Tail	4.83 [.190] ACTION PIN Tail
40	30.84 1.214	29.21 1.150	26.62 1.048	19	24.13 .950	149013-1◆	149014-1◆
60	43.54 1.714	41.91 1.650	39.32 1.548	29	36.83 1.450	149013-2◆	—
100	68.94 2.714	67.31 2.650	64.72 2.548	49	62.23 2.450	149013-4◆	—
140	94.34 3.714	92.71 3.650	90.12 3.548	69	87.63 3.450	149013-6◆	149014-6◆

**Note:** Refer to page 78 for information on ACTION PIN.

**Note:** Part Numbers are RoHS compliant except: ◆ Indicates non-RoHS compliant;  
● Indicates "5 of 6 compliant" (lead in solderable interface only).



## Micro-Strip Vertical Receptacles (Board-to-Board)

### Material and Finish

**Housing** — High-temperature thermo-plastic, flame retardant, natural color

**Receptacle Bus** — Phosphor bronze; duplex plated 0.00076 [.000030] gold in mating area, 0.00254 [.000100] tin-lead in terminating area, with entire bus underplated 0.00127 [.000050] nickel

**Receptacle Contact** — Phosphor bronze; duplex plated 0.00076 [.000030] gold in mating area, 0.00254 [.000100] tin-lead in terminating area, with entire contact underplated 0.00127 [.000050] nickel

### Related Product Data

**Performance Characteristics** — page 67

**Mating Plugs** — pages 68, 70-72

**Technical Documents** — page 81

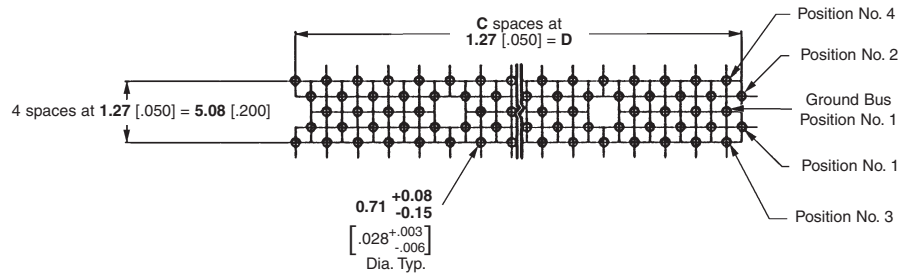
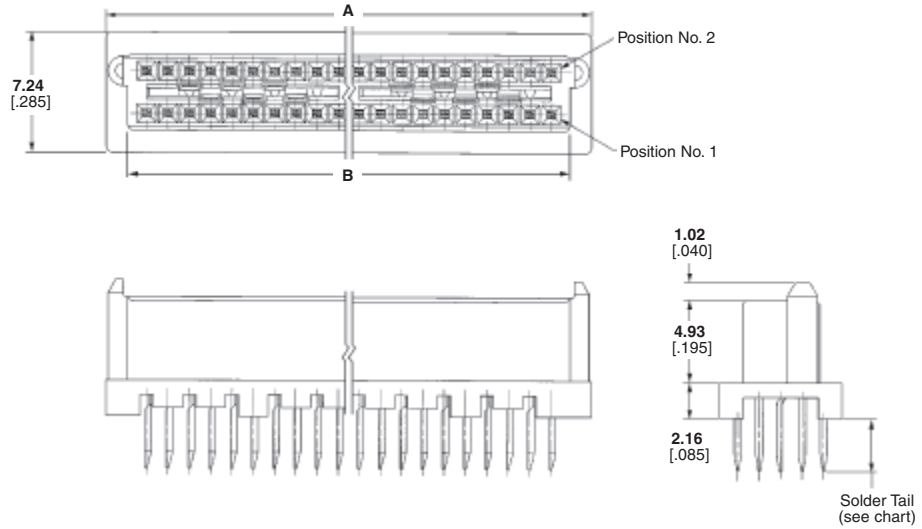

Recommended PC Board Layout  
(Connector Side of Board Shown)

No. of Positions	Dimensions				Part Numbers		
	A	B	C	D	2.41 [.095] Solder Tail	3.18 [.125] Solder Tail	4.57 [.180] Solder Tail
40	28.96 1.140	26.34 1.037	19	24.13 .950	536279-1●	536254-1●	536255-1●
60	41.66 1.640	39.01 1.537	29	36.83 1.450	536279-2●	536254-2●	536255-2●
80	54.36 2.140	51.74 2.037	39	49.53 1.950	536279-3●	536254-3●	536255-3●
100	67.06 2.640	64.44 2.537	49	62.23 2.450	536279-4●	536254-4●	536255-4●
120	79.76 3.140	77.14 3.037	59	74.93 2.950	536279-5●	536254-5●	536255-5●
140	92.48 3.640	89.84 3.537	69	87.63 3.450	536279-6●	536254-6●	536255-6●
160	105.16 4.140	102.54 4.037	79	100.33 3.950	536279-7●	536254-7●	536255-7●
180	117.86 4.640	115.24 4.537	89	113.03 4.450	536279-8●	536254-8●	—
200	130.56 5.140	127.94 5.037	99	125.73 4.950	536279-9●	536254-9●	536255-9●
220	143.26 5.640	140.64 5.537	109	138.43 5.450	1-536279-0●	—	—
240	155.96 6.140	153.34 6.037	119	151.13 5.950	1-536279-1●	—	—

**Note:** Part Numbers are RoHS compliant except: ● Indicates non-RoHS compliant;  
● Indicates "5 of 6 compliant" (lead in solderable interface only).

**Micro-Strip Right-Angle Receptacles (Board-to-Board)**

**Material and Finish**

**Housing** — High-temperature thermo-plastic, flame retardant, natural color

**Receptacle Bus** — Phosphor bronze; duplex plated 0.00076 [.000030] gold in mating area, 0.00254 [.000100] tin-lead in terminating area, with entire bus underplated 0.00127 [.000050] nickel

**Receptacle Contact** — Phosphor bronze; duplex plated 0.00076 [.000030] gold in mating area, 0.00254 [.000100] tin-lead in terminating area, with entire contact underplated 0.00127 [.000050] nickel

**Related Product Data**

**Performance Characteristics** — page 67

**Mating Plugs** — pages 68, 70-72

**Technical Documents** — page 81

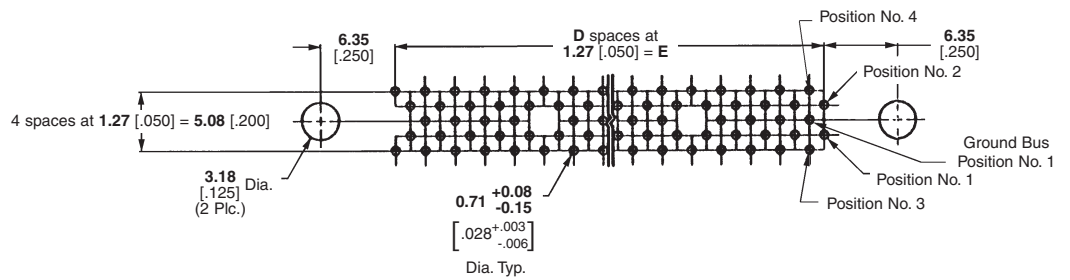
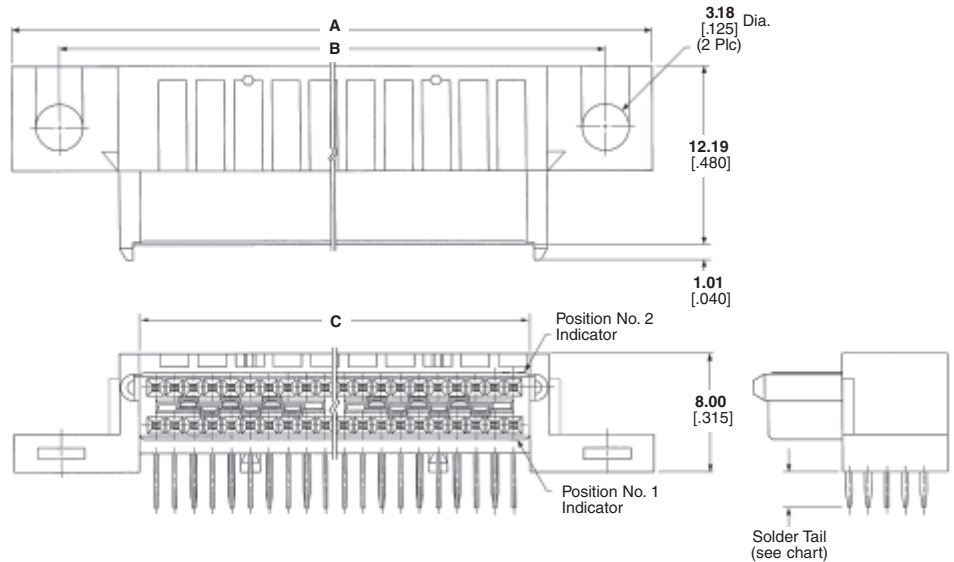

**Recommended PC Board Layout  
(Connector Side of Board Shown)**

No. of Positions	Dimensions					Part Numbers	
	A	B	C	D	E	2.41 [.095] Solder Tail	3.18 [.125] Solder Tail
40	43.18 1.700	36.83 1.450	26.34 1.037	19	24.13 .950	536295-1◆	536297-1◆
60	55.88 2.200	49.53 1.950	39.04 1.537	29	36.83 1.450	536295-2◆	536297-2◆
80	68.58 2.700	62.23 2.450	51.74 2.037	39	49.53 1.950	536295-3◆	536297-3◆
100	81.28 3.200	74.93 2.950	64.44 2.537	49	62.23 2.450	536295-4◆	536297-4◆
120	93.98 3.700	87.63 3.450	77.14 3.037	59	74.93 2.950	536295-5◆	536297-5◆
140	106.68 4.200	100.33 3.950	89.84 3.537	69	87.63 3.450	—	536297-6◆
160	119.38 4.700	113.03 4.450	102.54 4.037	79	100.33 3.950	536295-7◆	—
200	144.78 5.700	138.43 5.450	127.94 5.037	99	125.73 4.950	536295-9◆	536297-9◆

**Note:** Part Numbers are RoHS compliant except: ◆ Indicates non-RoHS compliant; ● Indicates "5 of 6 compliant" (lead in solderable interface only).

**Micro-Strip Right-Angle Receptacles with Guides (Board-to-Board)**

**Material and Finish**

**Housing** — High-temperature thermo-plastic, flame retardant, natural color

**Receptacle Bus** — Phosphor bronze; duplex plated 0.00076 [.000030] gold in mating area, 0.00254 [.000100] tin-lead in terminating area, with entire bus underplated 0.00127 [.000050] nickel

**Receptacle Contact** — Phosphor bronze; duplex plated 0.00076 [.000030] gold in mating area, 0.00254 [.000100] tin-lead in terminating area, with entire contact underplated 0.00127 [.000050] nickel

**Related Product Data**

**Performance Characteristics** — page 67

**Mating Plugs** — pages 69

**Technical Documents** — page 81

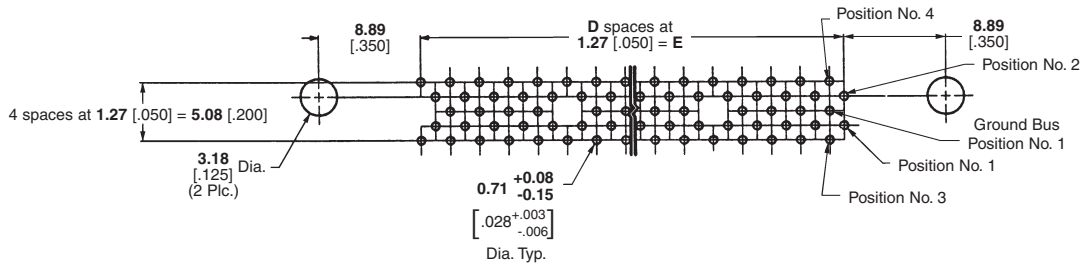
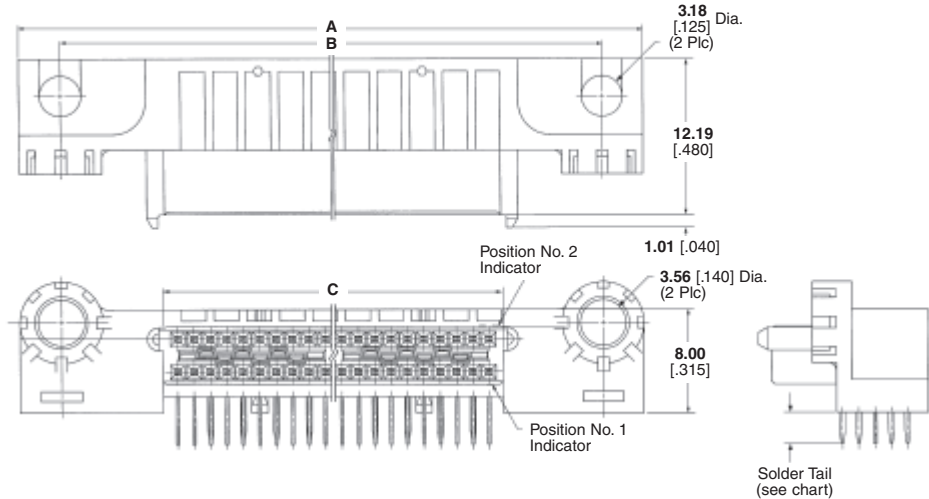

**Recommended PC Board Layout  
(Connector Side of Board Shown)**

No. of Positions	Dimensions					Part Numbers	
	A	B	C	D	E	2.41 [.095] Solder Tail	3.18 [.125] Solder Tail
40	48.26 1.900	41.91 1.650	26.34 1.037	19	24.13 .950	536296-9◆	—
140	111.76 4.400	105.41 4.150	89.84 3.537	69	87.63 3.450	536296-3◆	—
160	124.46 4.900	118.11 4.650	102.54 4.037	79	100.33 3.950	536296-4◆	149031-1◆
200	149.86 5.900	143.51 5.650	127.94 5.037	99	125.73 4.950	536296-6◆	—
240	175.26 6.900	168.91 6.650	153.34 6.037	119	151.13 5.950	—	149031-2◆

**Note:** Part Numbers are RoHS compliant except: ◆ Indicates non-RoHS compliant;  
● Indicates "5 of 6 compliant" (lead in solderable interface only).