

**Note:** All part numbers are RoHS Compliant.

## Circular Plastic Connector Sealing Accessories

### Sealing Caps for Receptacles only

Sealing caps are used to protect exposed contacts of unmated receptacles.

#### Material and Finish

**Cap**—Thermoplastic, heat stabilized, fire resistant, self-extinguishing, 94V-1 rated, black

**Sealing Gasket**—Neoprene, black

**Bead Chain**—Steel, nickel plated

**Bead Chain Coupling**—Brass, plated nickel



Shell Size	Series	Dimensions		Plastic Strap Part No.	Metal Bead Chain Part No.
		A	B		
11	1 & 2	.360 9.14	.927 23.55	206903-1	208800-1
13	1	.360 9.14	1.055 26.80	211870-1	213485-1
17	1,2,& 3	.360 9.14	1.295 32.89	207445-1	208652-1
23	1, 3, & 4	.460 11.68	1.728 43.89	207446-1	208680-1
	2			207446-2	208680-2

### Cable Entry Seals Heat Shrinkable Sealing Boots

Cable entry seals are used with jacketed cable to provide an environmentally sealed wire-to-connector system. They can be used with either plugs or receptacles.

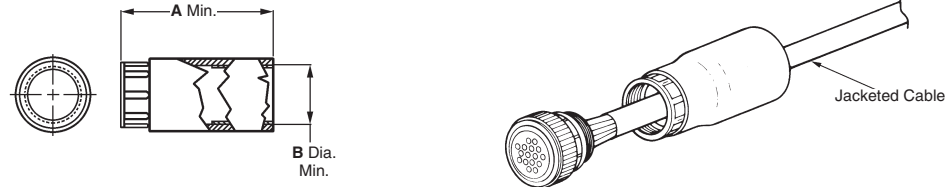

Shell Size	Dimensions		Expanded Wall Thickness	Sealing Range (Dia.)	Max. Recovered Inside Diameter	Part No.
	A	B				
11	2.500 63.50	.625 15.88	.050 1.27 Ref.	.250 - .600 6.35 - 15.24	.160 4.06	54010-4
					.250 6.35	54010-1
13	2.500 63.50	.775 19.68	.060 Ref. 1.52	.250 - .375 6.35 - 9.53	.220 5.59	54123-2
					.375 - .725 9.53 - 18.42	.300 7.62
17	2.500 63.50	.975 24.76	.060 Ref. 1.52	.400 - .875 10.16 - 22.22	.375 9.52	54011-1
	3.000 76.20					
23	3.000 76.20	1.250 31.75	.070 Ref. 1.78	.550 - 1.250 13.97 - 31.75	.500 12.70	54012-1

### Thick Wall Boots

#### Material

**Internal Sleeve**—Nylon

**Outer Tubing**—Polyolefin, black

CPC Sealing Accessories

### Thin Wall Boot

#### Material

**Inter Sleeve**—Nylon

**Outer Tubing**—Polyolefin

**Expanded Wall Thickness**—  
.020 [0.51]

**Max. Recovered Wall Thickness**—  
.040 [10.16]

**Sealing Range**—.250 [6.35]-  
.500 [12.70] Dia.

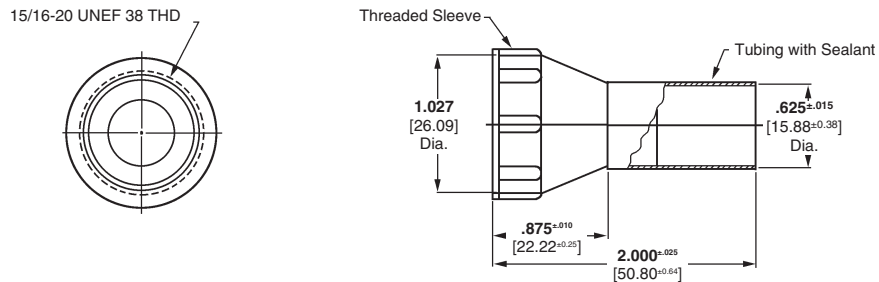

Shell Size 17  
Part No. 213933-1

**Circular Plastic Connector Sealing Accessories (Continued)**

**Jacketed Cable Seals (for Shell Size 23)**

A jacketed cable seal kit provides an environmentally sealed connection for jacketed cable.

**Material**

**Peripheral Seal**—Grey elastomer

**Collar**—Aluminum

**Jacketed Cable Seal**—Black rubber

**Back-Shell Extender**—Black glass-filled thermoplastic

**Special Clamp Saddle**—Black thermoplastic

**Note:** Jacketed cable seals must be used with large cable clamps and can be used on plugs or receptacles. Large cable clamps are to be ordered separately (see page 38). Each jacketed cable seal kit includes:

- Peripheral Seal—to be discarded if kit is used on plug. Additional seals may be purchased (see page 51)
- Collar—provides bearing surface for back-shell extender
- Jacketed Cable Seal
- Back-Shell Extender
- Special Clamp Saddle—to be used in lieu of clamping insert supplied with large cable clamp

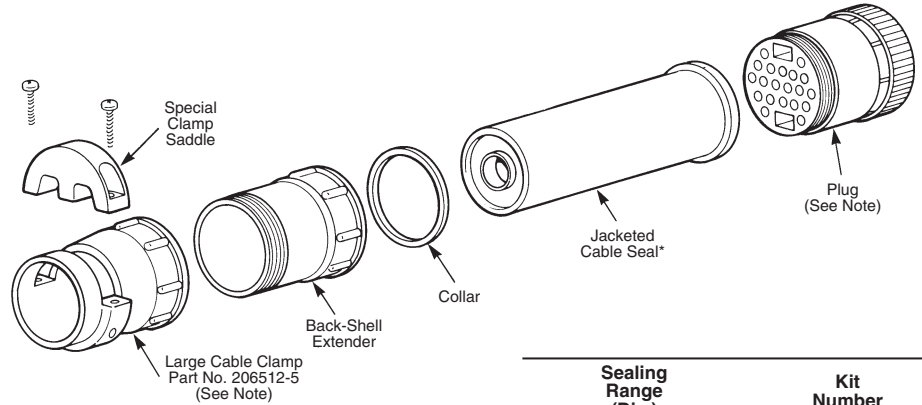
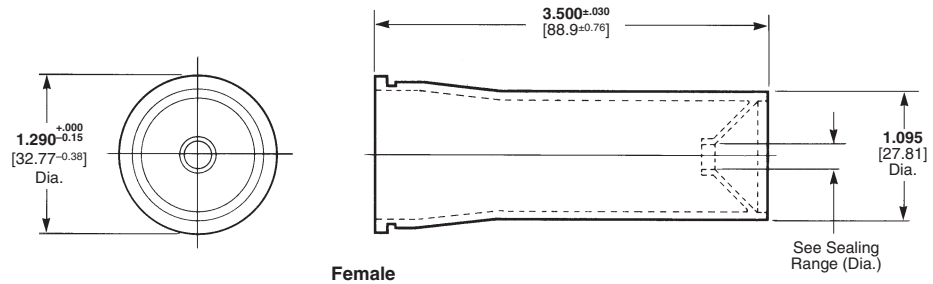

\*Jacketed cable seal is pressed flush against rear connector face when back-shell extender is threaded onto rear of connector.

Sealing Range (Dia.)	Kit Number
.300-.450 7.62-11.43	207052-1
.450-.600 11.43-15.24	207052-2
.600-.875 15.24-22.22	207052-3

**Rubber Boot**

Rubber boots are used with jacketed cable to provide splash-proof connections for Series 1 and Series 3 connectors. (Not for Metal Shell Connectors.)

**Material**

Black neoprene

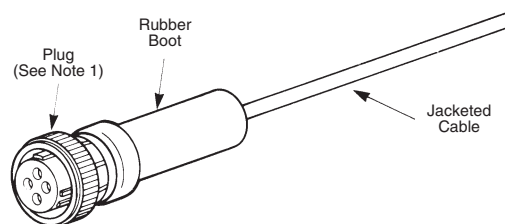
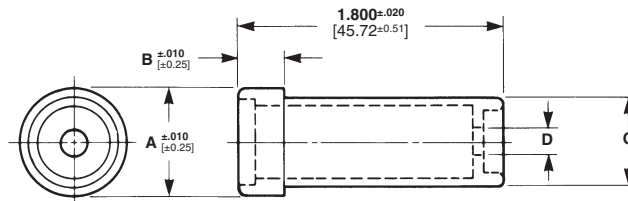

Shell Size	Cable Dia. Sealing Range	Dimensions				Part No.
		A	B	C	D	
11	.219-.438 5.56-11.13	.750 19.05	.300 7.62	.600 15.24	.170 4.32	206304-1

- Notes:**
1. Rubber boots are recommended for use with jacketed cable and can be used on plugs or receptacles, except Series 2 connectors.
  2. For detailed performance data on rubber boots, refer to Product Specification No. 108-10024.

**Circular Plastic Connector Sealing Accesories** (Continued)

**Flexible Cable Protection System**

**Product Facts**

- For cables that require better protection
- Fittings allow more reliable connections to be made
- Sealed fittings enhance reliability of machinery operating under many extreme environmental conditions encountered in manufacturing and construction industries
- High-quality, complete systems are available combining innovative technology with rapid in-stock availability
- Conforms with the latest industry standards
- Recognized under the Component Program of Underwriters Laboratories Inc.  on applied products as marked.
- Certified by Canadian Standards Association  on applied products as marked.
- Certified by VDE  on applied products as marked.

**Related Product Data**

Catalog 1654227  
Identification Products

**Technical Documents**

**Product Specifications**

- 108-1696 FLEXAgraff Metal Conduits
- 108-1696-1 ROHRflex Plastic Tubing
- 108-1696-2 AIRflex Plastic Conduits

**Application Specifications**

- 114-18274 FLEXAgraff-AS, -PU-AS, -ME-ASF Metal Conduits
- 114-18275 FLEXAgraff-CU Metal Conduits
- 114-18276 AIRflex-KUW-PU Plastic Conduits
- 114-18277 ROHRflex-PA 6, ROHRflex-PA 6 S, ROHRflex-PA 12 Plastic Tubing

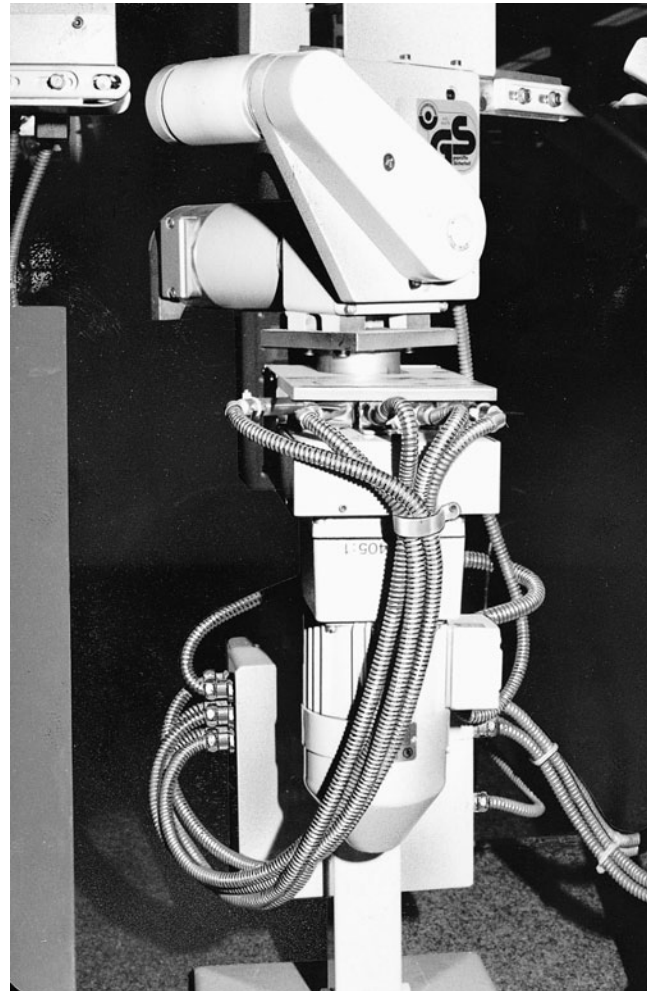

Typical Industrial Application



**Circular Plastic Connectors (CPC) / FLEXAquick-System Selection Aid**

CPC Shell Size	Female ROHRflex quick Connector	ROHRflex-PA 6 Plastic Tubing	Male ROHRflex quick Connector	Male ROHRflex quick Elbow Connector	Counternut	Flat Sealing Washer
11	1-969807-2	969789-2	969803-2	969817-2	796260-2	796257-2
13	1-969809-3	969789-3	969803-3	969817-3	796260-3	796257-7
17	1-969811-4	969789-4	969803-4	969817-4	796260-5	796257-8
23	2-969813-5	969789-5	969803-5	969817-5	796260-6	796257-9

**NOTE:**  
Request Flexible Cable Protection System Catalog 1307244.

---

## Engineering Notes

---



## MIL-C-5015 Style Circular Plastic Connectors (CPC)

### Product Facts

- Intermateable with other manufacturers' Metal-Shell Sizes 20-14 and 18-10, MIL-C-5015 Style Connectors
- High impact resistant plastic housing
- Lighter weight
- Lower cost
- Industry accepted, Type III+ pin and socket contacts, available on reels in strip-form for high volume, low cost, automatic machine terminations
- Contacts also available in loose piece form for low volume, prototype or maintenance and repair
- Housing designed to prevent mismatching with other insert arrangements
- Recognized under the Component Program of Underwriters Laboratories Inc., File No. E28476 
- Certified by Canadian Standards Association, File No. LR 7189 



This new addition to the AMP Circular Plastic Connector Line is specifically designed to be intermateable with other manufacturers' Metal-Shell sizes 20-14 and 18-10, MIL-C-5015 Style Connector Systems. The high impact resistant plastic housing offers the advantages of lighter weight and lower cost than existing metal shell connectors. In addition, the connector design prevents mismatching when used with other insert arrangements. As part of the AMP Multimate Family of Connectors, the MIL-C-5015 style connector offers the additional economies of crimp Type III+ Pin and Socket contacts in reel-mounted, strip-form for high volume automatic machine termination, as well as in loose piece form for low volume, prototype or maintenance and repair.

### Technical Documents

#### Application Specification

114-10004 Contacts, Type III+

#### Product Specifications

108-10024 CPC Connectors  
108-10042 Contacts, Type III+

#### Instruction Sheets

408-7582 Accessories for CPC Connectors  
408-7592-A Improved Strain Relief Clamps for CPC Connectors  
408-7593 CPC Connectors

**MIL-C-5015 Style Circular Plastic Connectors (CPC), Shell Size 20-14**

**Plug Kit, Unassembled**

Reverse Sex (Accepts pins)  
**Part Number 213571-2**  
without Cable Clamp

Standard Sex (Accepts sockets)  
**Part Number 213652-1**  
without Cable Clamp

Cable Clamps	O.D.	
Part No.	Type	Max.
206070-8	standard	.453 [11.51]
206322-9	large	.703 [17.86]



Assembled with Cable Clamp

5-20 Self Tapping Screw,  
Quantity 2

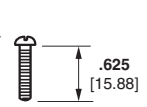

Clamping Inserts  
.703  
[17.86]  
Max. Outside Dia.

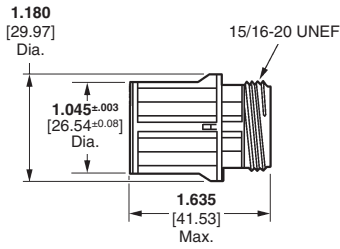

Standard Sex

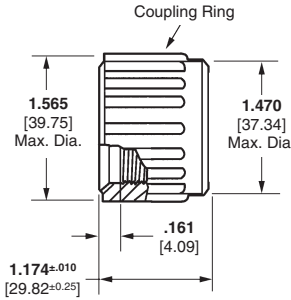

Coupling Ring

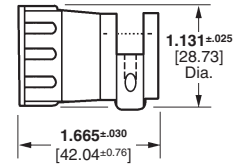

**Receptacle, Square Flange**

Reverse Sex (Accepts sockets)  
**Part Number 213570-1**  
Standard Sex (Accepts pins)  
**Part Number 213651-1**

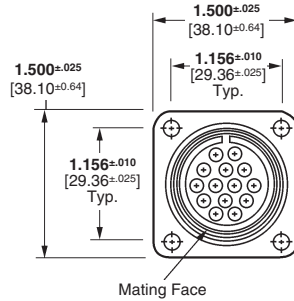

Mating Face

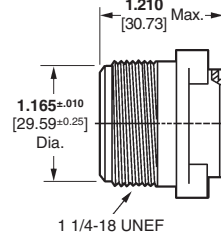

Reverse Sex

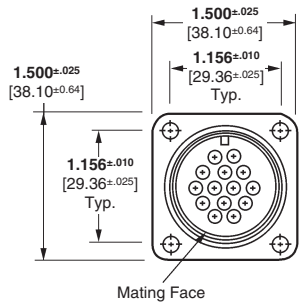

Mating Face

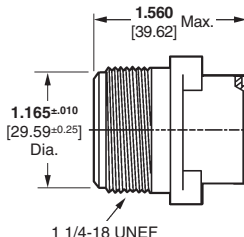

Standard Sex

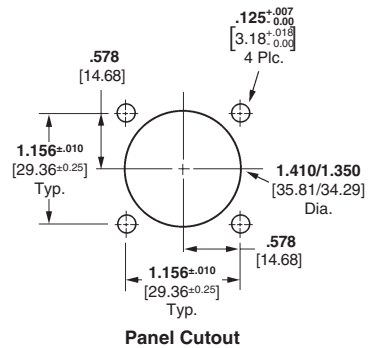

Panel Cutout

**Receptacle, Free-Hanging**

Reverse Sex (Accepts sockets)  
**Part Number 213650-1**

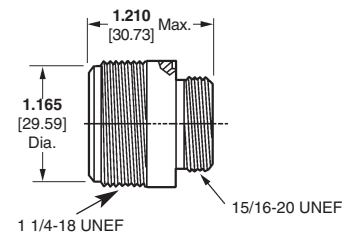
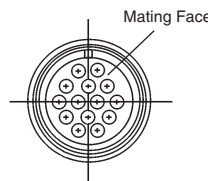

**MIL-C-5015 Style Circular Plastic Connectors (CPC), Shell Size 18-10**

**Plug Kit, Unassembled**

Reverse Sex (Accepts pins)  
**Part Number 213671-1**  
 without Cable Clamp

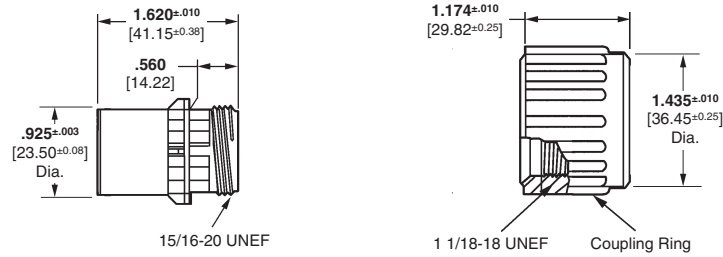

**Receptacle, Square Flange**

Reverse Sex (Accepts sockets)  
**Part Number 213667-1**

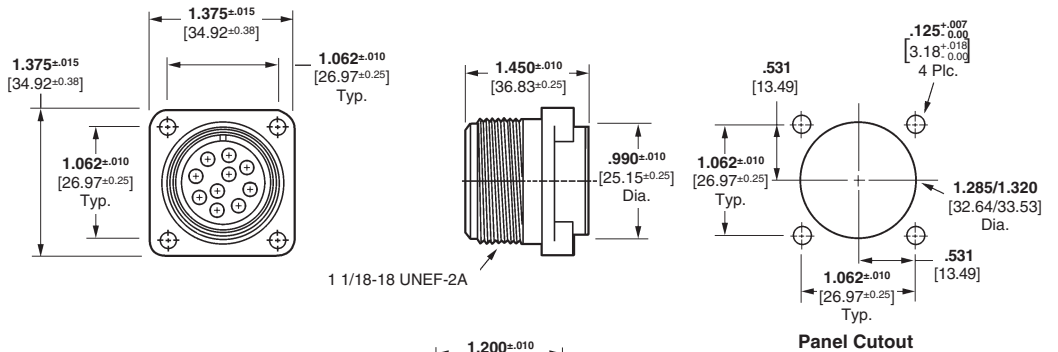

**Receptacle, Free-Hanging**

Reverse Sex (Accepts sockets)  
**Part Number 213668-1**

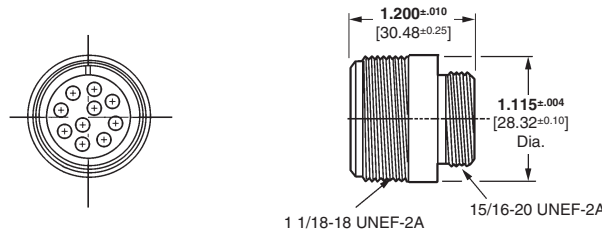

**Type III+ Contacts**

**Material**

**Contact**—Brass  
**Spring**—Stainless Steel

**Contact Finish**

**A**—.000030 [0.00076] gold on the electrical engagement area over .000030 [0.00076] min. nickel  
**B**—Tin

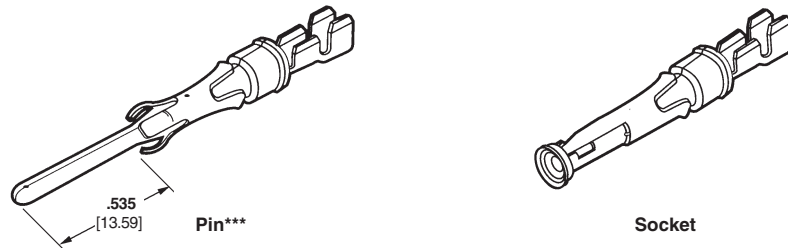

**Related Product Data**

**Application Tooling**—Pages 76-79

Wire Size Range AWG mm <sup>2</sup>	Ins. Dia. Range	Contact Finish Code	Strip Form Contact No.		Loose Piece Contact No.		Strip Form Applicator	Hand Tool Part No.
			Pin	Socket	Pin	Socket		
24-20 0.2-0.6	.060-.135 1.52-3.43	B	213605-7	1-66563-1	—	66565-7	567363-□ <sup>††</sup>	91542-1 <sup>5</sup>
		A	—	66563-8	—	66565-4		
18-14 0.8-2	.110-.150 2.79-3.81	B	213603-5	66598-9	213603-6	66601-9	466958-1 <sup>††</sup> (for Sockets) or 567364-□ <sup>††</sup> or 567834-1 <sup>††</sup> (for Sockets)	91521-1 <sup>5</sup>
		A	213603-3	66598-2	213603-4	66601-2		

<sup>††</sup>**Note:** Applicators for AMP semiautomatic or fully-automatic termination equipment are available. Contact Technical Support.

<sup>\*\*\*</sup>MIL-C-5015 style connectors require a longer Multimate pin contact. This contact is .145 [3.68] longer than the standard Multimate pin contacts. It is **not** for use in other Multimate connectors, socket contacts are standard Multimate Type III+ contacts.

**Extraction Tool Part No. 305183**

**Note:** Gold-plated contacts should not be mated with tin or silver plated contacts.

<sup>†</sup>To use with the 626 Pneumatic Tool System: remove the crimping head from the Straight Action Hand Tool (SAHT) Assembly, order SAHT Adapter **Part No. 217201-1**, Adapter Holder **Part No. 356304-1** (with ratchet) or **189928-1** (without), and Power Unit **Part No. 189721-1** (hand actuated) or **189722-1** (foot actuated).

---

## Engineering Notes

---





## Metal-Shell Circular Plastic Connectors

### Product Facts

- Economical combination of thermoplastic UL 94V-0 rated connector housings and metal shells
- Available in three sizes:
  - Series 1—Accepts Multimate contacts, shell sizes 14-5, 14-7, 22-16, 28-24, and 28-37 standard sex; 14-5, 14-7, 22-14, and 28-37 reverse sex
  - Series 2—Accepts 20 DF and 20 DM contacts, shell sizes 22-28 and 28-63 standard sex; 22-28 and 28-57 reverse sex
  - Series 3—Accepts Type XII power contacts, shell sizes 22-3 and 28-7 standard and reverse sex
- Series 4—Accepts Multimate contacts, and Type XII power contacts, shell size 28-16M and 28-22M standard sex
- Compatible with MIL Spec metal housing type connectors
- Choice of application tooling to meet all production requirements



AMP Metal-Shell Circular Plastic Connectors offer the reliability of higher priced all metal connectors at a fraction of the cost, and are offered in the more popular contact configurations.

Connector housings are made of lightweight, sturdy, thermoplastic material that are UL 94V-0 rated, with zinc alloy, nickel plated shells for added strength and protection. These connectors are available in a variety of configurations to meet your signal, low current and high current requirements. Operating temperatures range from -55°C to +125°C [-67°F to +257°F].

Signal and low current is provided by a choice of AMP Multimate contacts: .062 [1.57] pin diameter and 20 DF and 20 DM contacts, .040 [1.02] pin diameter. High current requirements are met by the Type XII capable of carrying up to 35 amperes of current.

These quick connect/disconnect circular connectors feature polarized housings to prevent mismatching with other insert arrangements.

AMP Metal-Shell Circular Plastic Connectors are available in square flange receptacles and free-hanging plug connectors.

For additional economy, industry accepted AMP Type III+ pin and socket contacts are available on reels in strip-form for high volume, low cost, automatic machine terminations. For low volume, prototype or maintenance and repair Type III+ contacts are also available in loose piece form.

**Note:** All part numbers  
are RoHS Compliant.

## Metal-Shell Circular Plastic Connectors, Series 1

### Metal-Shell CPC Connectors, Series 1, Standard Sex



Listed part numbers are for  
connectors only; **contacts must  
be ordered separately.**

#### Material and Finish

##### Square Flange Receptacle—

**Housing**—Thermoplastic, UL 94V-0  
rated, black

**Metal-Shell**—Zinc alloy, plated nickel

**Grooved Pin**—Steel alloy, plated nickel

##### Plug—

**Housing**—Thermoplastic, UL 94V-0  
rated, black

**Metal-Shell**—Zinc alloy, plated nickel

**Tetraseal Seal**—Fluorocarbon

**Retainer Ring**—Stainless steel

**Coupling Ring**—Zinc alloy, plated  
nickel

#### Related Product Data

**Contacts**—Pages 17-21

**Contact Arrangement**—Page 61

**Component Dimensions**—Page 70

**Accessories**—Page 71

**Performance Characteristics**—  
Page 6

**Application Tooling**—Pages 76-79

**Technical Documents**—Page 80

### Square Flange Receptacles

(Accepts Multimite Pins)

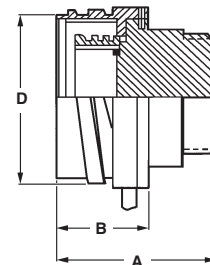

### Plugs

(Accepts Multimite Sockets)

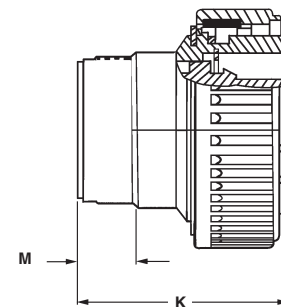
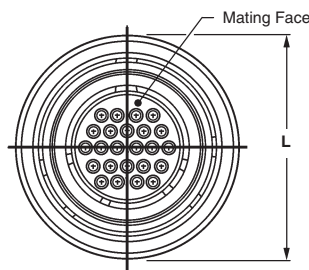

Arrangement	Square Flange Receptacle	Plug Part No.	
		without TETRASEALS Ring	with TETRASEALS Ring
14-5	208719-1	208718-1	208718-2
14-7	208715-1	208714-1	208714-2
22-16	208489-1	208488-1	208488-3
28-24	208459-1	208457-1	208457-3
28-37	208471-1	208470-1	208470-3

**Note:** Maximum wire insulation diameter is .100 [2.54], except arrangements 14-5 and 28-24 are .150 [3.81] max.

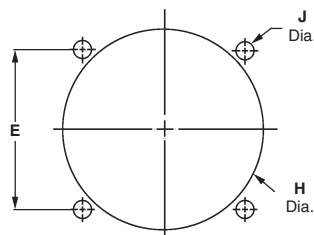

Rear Mount Panel Cutout

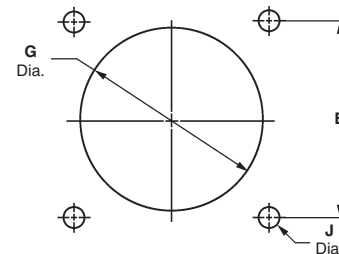

Front Mount Panel Cutout

### TETRASEALS Ring

(Installed in plugs only.)

The TETRASEALS Ring provides splash-  
proof sealing between mating metal  
shells. It is located behind the plug shell  
external keys (under the coupling ring).  
When mated with a receptacle, the ring  
is compressed against the inside  
diameter of the mating end edge of the  
receptacle shell.

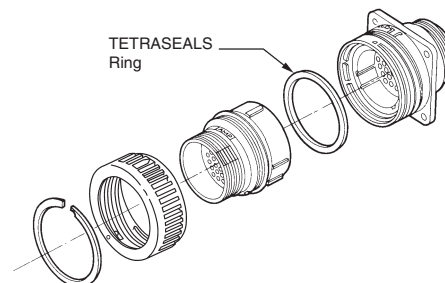

**Note:** All part numbers are RoHS Compliant.

**Metal-Shell Circular Plastic Connectors, Series 1 (Continued)**

**Metal-Shell CPC Connectors, Series 1, Reverse Sex**



Listed part numbers are for connectors only; **contacts must be ordered separately.**

**Material and Finish**

- Square Flange Receptacle—**
- Housing—**Thermoplastic, UL 94V-0 rated, black
- Metal-Shell—**Zinc alloy, plated nickel
- Grooved Pin—**Steel alloy, plated nickel

- Plug—**
- Housing—**Thermoplastic, UL 94V-0 rated, black
- Metal-Shell—**Zinc alloy, plated nickel
- Tetraseal Seal—**Fluorocarbon
- Retainer Ring—**Retainer Ring
- Coupling Ring—**Zinc alloy, plated nickel

**Related Product Data**

- Contacts—**Pages 17-21
- Contact Arrangement—**Page 61
- Component Dimensions—**Page 70
- Accessories—**Page 71
- Performance Characteristics—**Page 6
- Application Tooling—**Pages 76-79
- Technical Documents—**Page 80

**Square Flange Receptacles**  
(Accepts Multimate Sockets)

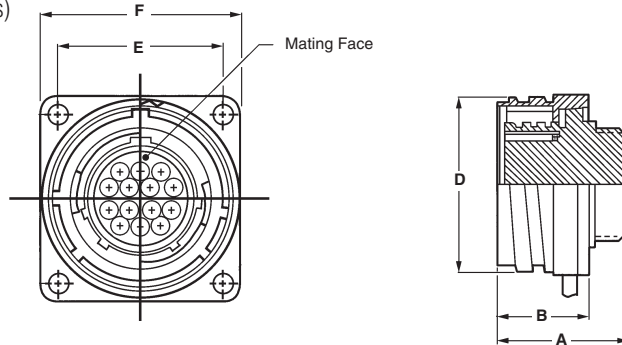

**Plugs**  
(Accepts Multimate Pins)



Arrangement	Square Flange Receptacle	Plug Part No.	
		without TETRASEALS Ring	with TETRASEALS Ring
14-5	208721-1	208720-1	—
14-7	208717-1	208716-1	208716-2
22-14	208487-1	208486-1	208486-3
28-37	208473-1	208472-1	208472-3

**Note:** Maximum wire insulation diameter is .100 [2.54], except arrangements 14-5 and 28-24 are .150 [3.81] max.

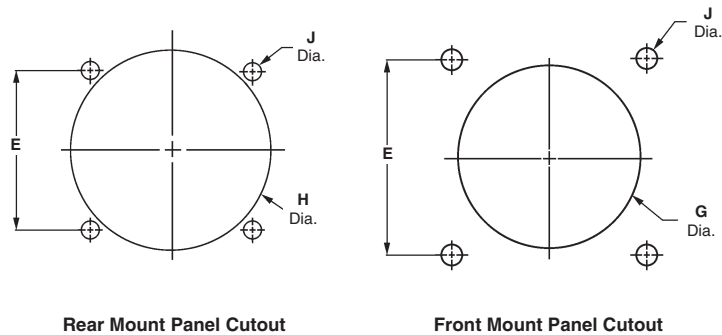

**TETRASEALS Ring**  
(Installed in plugs only.)

The TETRASEALS Ring provides splash-proof sealing between mating metal shells. It is located behind the plug shell external keys (under the coupling ring). When mated with a receptacle, the ring is compressed against the inside diameter of the mating end edge of the receptacle shell.

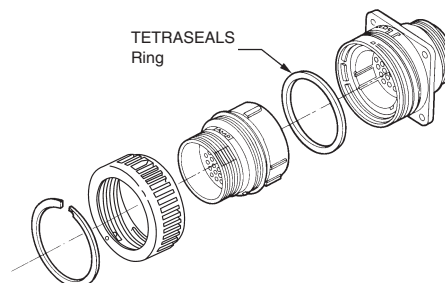

Metal-Shell CPC Series 1

**Metal-Shell CPC Connectors, Series 1, Contact Arrangements**

**Shell Size 14**



**Arrangement 14-5**  
Max. Wire Ins. Dia. = .150 [3.81]



**Arrangement 14-7**  
Max. Wire Ins. Dia. = .100 [2.54]

**Shell Size 22**



**Arrangement 22-14**  
Max. Wire Ins. Dia. = .100 [2.54]



**Arrangement 22-16**  
Max. Wire Ins. Dia. = .100 [2.54]

**Note:** Contact arrangements shown are of pin mating face (plug or receptacle). Socket mating face is mirror image.

**Shell Size 28**

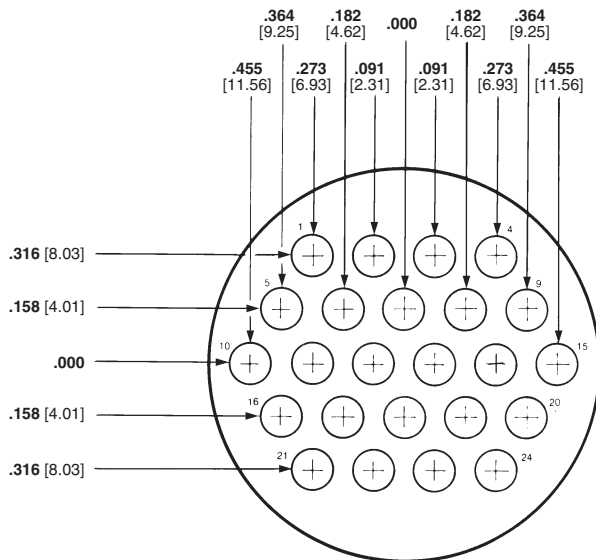

**Arrangement 28-24**  
Max. Wire Ins. Dia. = .150 [3.81]

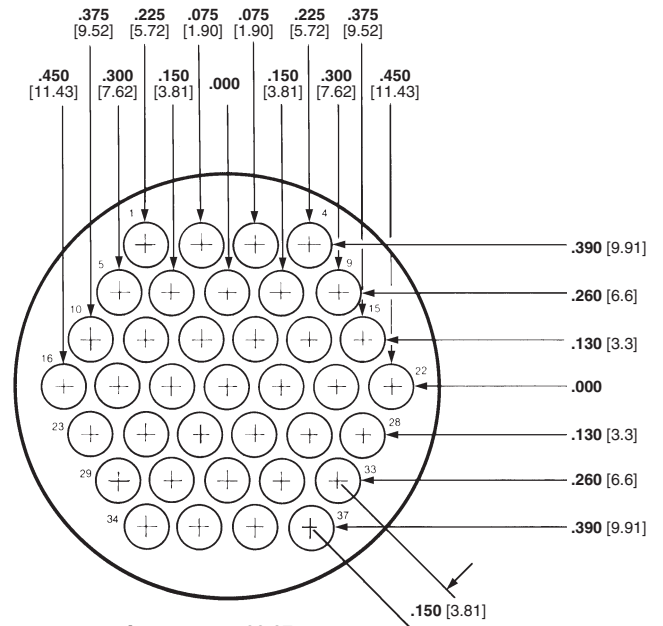

**Arrangement 28-37**  
Max. Wire Ins. Dia. = .100 [2.54]

**Note:** All part numbers are RoHS Compliant.

**Metal-Shell Circular Plastic Connectors, Series 2**

**Metal-Shell CPC Connectors, Series 2, Standard Sex**



Listed part numbers are for connectors only; **contacts must be ordered separately.**

**Material and Finish**

- Square Flange Receptacle**—Thermoplastic, UL 94V-0 rated, black
- Housing and Retention Insert**—Thermoplastic, UL 94V-0 rated, black
- Metal-Shell**—Zinc alloy, plated nickel
- Grooved Pin**—Steel alloy, plated nickel

- Plug**—Thermoplastic, UL 94V-0 rated, black
- Housing**—Thermoplastic, UL 94V-0 rated, black
- Metal-Shell**—Zinc alloy, plated nickel
- Tetraseal Seal**—Fluorocarbon
- Retainer Ring**—Stainless steel
- Coupling Ring**—Zinc alloy, plated nickel

**Square Flange Receptacles**  
(Accepts 20 DF and 20 DM Pins)

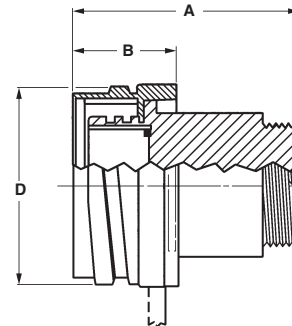
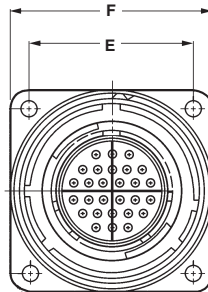

**Plugs**  
(Accepts 20 DF and 20 DM Sockets)

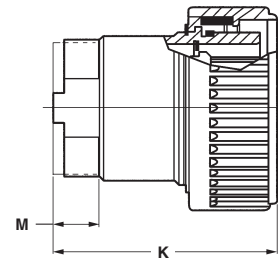

**Related Product Data**

- Contacts**—Pages 29-30
- Contact Arrangement**—Page 64
- Component Dimensions**—Page 70
- Accessories**—Pages 38, 39 and 71
- Performance Characteristics**—Page 6
- Application Tooling**—Pages 76-79
- Technical Documents**—Page 80

Arrangement	Part No.	
	Square Flange Receptacle	Plug without Tetraseals Ring
22-28	208491-1	208490-1
28-63	208477-1	208476-1

Metal-Shell CPC Series 2

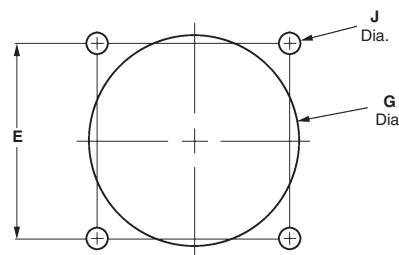

**Recommended Panel Cutout**

**Metal-Shell Circular Plastic Connectors, Series 2 (Continued)**

**Metal-Shell CPC Connectors, Series 2, Reverse Sex**



Listed part numbers are for connectors only; **contacts must be ordered separately.**

**Material and Finish**

- Square Flange Receptacle—Housing and Retention Insert—**Thermoplastic, UL 94V-0 rated, black
- Metal-Shell—**Zinc alloy, plated nickel
- Grooved Pin—**Steel alloy, plated nickel

- Plug—Housing—**Thermoplastic, UL 94V-0 rated, black
- Metal-Shell—**Zinc alloy, plated nickel
- Tetraseal Seal—**Fluorocarbon
- Retainer Ring—**Stainless steel
- Coupling Ring—**Zinc alloy, plated nickel

**Related Product Data**

- Contacts—**Pages 29-30
- Contact Arrangement—**Page 64
- Component Dimensions—**Page 70
- Accessories—**Pages 38, 39 and 71
- Performance Characteristics—**Page 6
- Application Tooling—**Pages 76-79
- Technical Documents—**Page 80

**Square Flange Receptacles**  
(Accepts 20 DF and 20 DM Sockets)

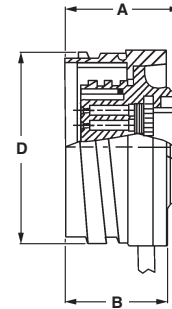
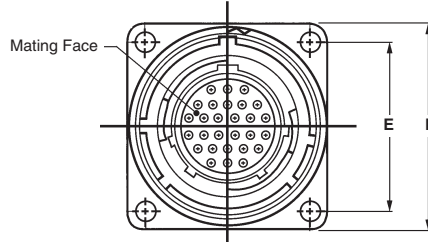

**Plugs**  
(Accepts 20 DF and 20 DM Pins)

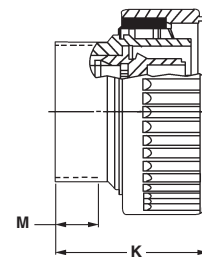
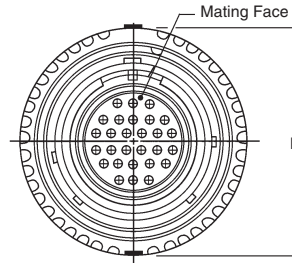

Arrangement	Part No.	
	Square Flange Receptacle	Plug without Tetraseals Ring
22-28	208493-1	208492-1
28-57	208475-1	208474-1

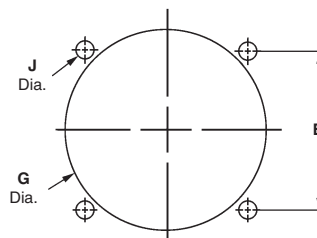

Rear Mount Panel Cutout

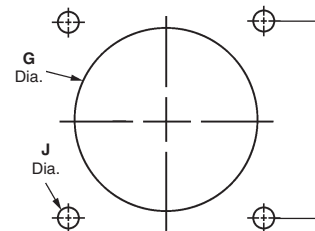

Front Mount Panel Cutout

**Metal-Shell CPC Connectors, Series 2, Contact Arrangements**

**Shell Size 22**

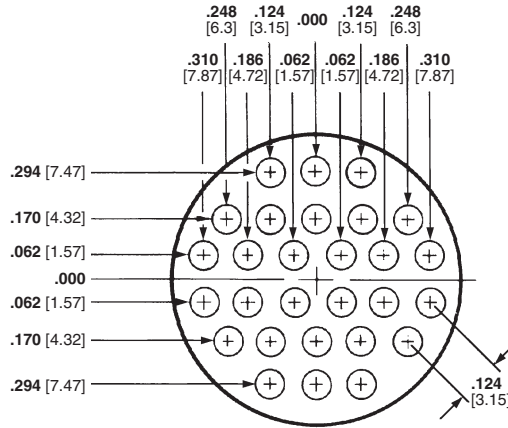

**Arrangement 22-28**  
Max. Wire Ins. Dia. = .068 [1.73]

**Shell Size 28**

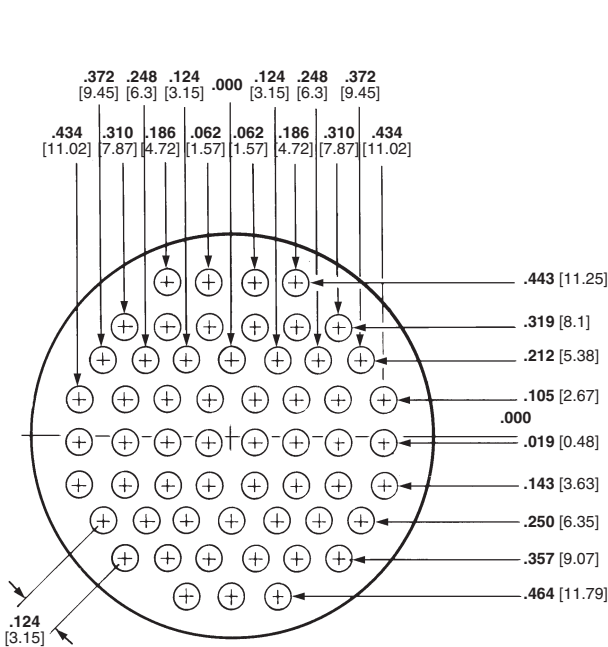

**Arrangement 28-57**  
Max. Wire Ins. Dia. = .068 [1.73]

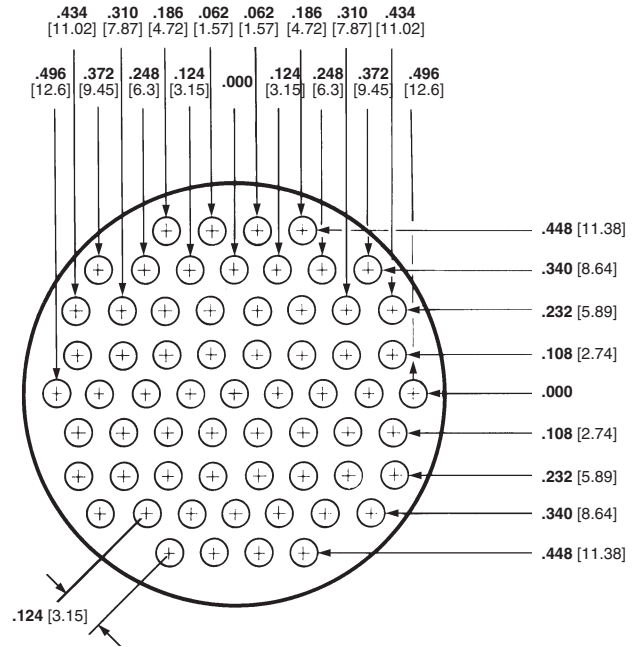

**Arrangement 28-63**  
Max. Wire Ins. Dia. = .068 [1.73]

**Note:** Contact arrangements shown are of pin mating face (plug or receptacle). Socket mating face is mirror image.

**Metal-Shell CPC Series 2**

## Metal-Shell Circular Plastic Connectors, Series 3

### Metal-Shell CPC Connectors, Series 3, Standard Sex



Listed part numbers are for connectors only; **contacts must be ordered separately.**

#### Material and Finish

##### Square Flange Receptacle—

**Housing**—Thermoplastic, UL 94V-0 rated, black

**Metal-Shell**—Zinc alloy, plated nickel

**Peripheral Seal**—Elastomer, grey

**Grooved Pin**—Stainless steel

##### Plug—

**Housing**—Thermoplastic, UL 94V-0 rated, black

**Metal-Shell**—Zinc alloy, plated nickel

**Tetraseal Seal**—Fluorocarbon

**Retainer Rings**—Stainless Steel

**Coupling Ring**—Zinc alloy, plated nickel

### Square Flange Receptacles

(Accepts Type XII Male Pins)

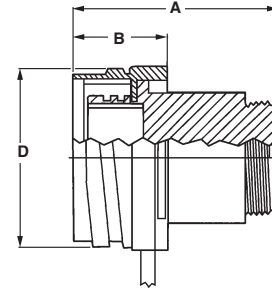
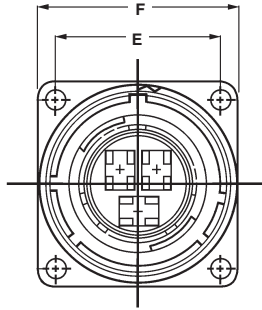

### Plugs

(Accepts Type XII Female Sockets)

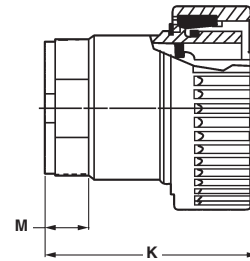
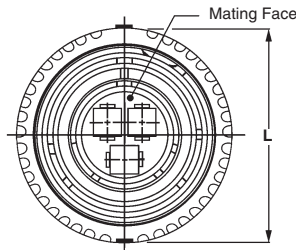

#### Related Product Data

**Contacts**—Page 34-35

**Contact Arrangement**—Page 67

**Component Dimensions**—Page 70

**Accessories**—Pages 38, 39 and 71

**Performance Characteristics**—Page 6

**Application Tooling**—Pages 76-79

**Technical Documents**—Page 80

Arrangement	Square Flange Receptacle	Plug Part No.	
		without TETRASEALS Ring	with TETRASEALS Ring
22-3	208495-1	208494-1	208494-3
28-7	208483-1	208482-1	—

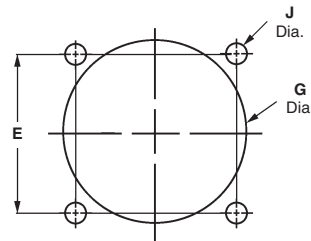

Recommended Panel Cutout

### TETRASEALS Ring

(Installed in Plugs only)

The TETRASEALS Ring provides splash-proof sealing between connector metal-shells. It is located behind the plug-shell external keys (under the coupling ring). When mated with a receptacle, the ring is compressed against the inside diameter of the mating end edge of the receptacle shell.

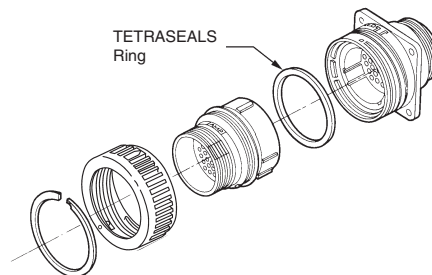



**Note:** All part numbers are RoHS Compliant.

**Metal-Shell Circular Plastic Connectors, Series 3 (Continued)**

**Metal-Shell CPC Connectors, Series 3, Reverse Sex**



Listed part numbers are for connectors only; **contacts must be ordered separately.**

**Material and Finish**

- Square Flange Receptacle—**
- Housing—**Thermoplastic, UL 94V-0 rated, black
- Metal-Shell—**Zinc alloy, plated nickel
- Peripheral Seal—**Elastomer, grey
- Grooved Pin—**Stainless steel
- Plug—**
- Housing—**Thermoplastic, UL 94V-0 rated, black
- Metal-Shell—**Zinc alloy, plated nickel
- Tetraseal Seal—**Fluorocarbon
- Retainer Rings—**Stainless Steel
- Coupling Ring—**Zinc alloy, plated nickel

**Square Flange Receptacles (Accepts Type XII Female Sockets)**

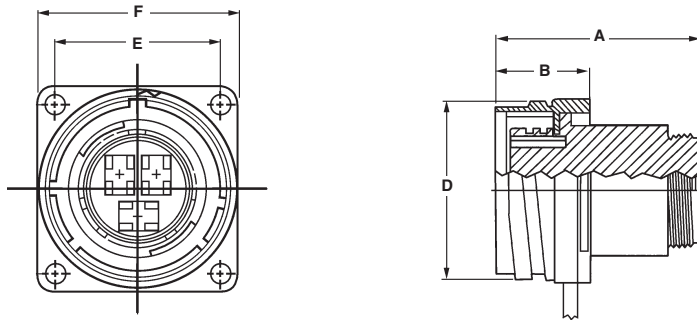

**Plugs (Accepts Type XII Male Pins)**

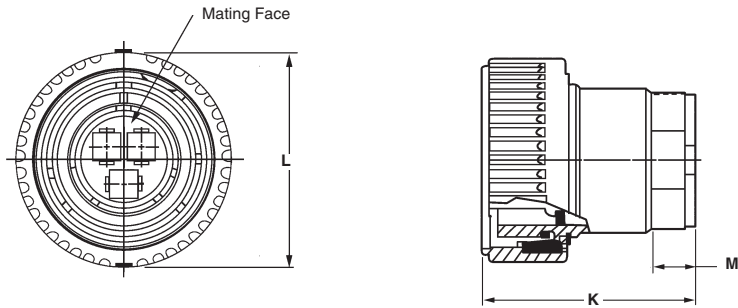

**Related Product Data**

- Contacts—**Page 34-35
- Contact Arrangement—**Page 67
- Component Dimensions—**Page 70
- Accessories—**Pages 38, 39 and 71
- Performance Characteristics—**Page 6
- Application Tooling—**Pages 76-79
- Technical Documents—**Page 80

Arrangement	Square Flange Receptacle	Plug Part No.	
		without TETRASEALS Ring	with TETRASEALS Ring
22-3	208497-1	208496-1	—
28-7	208485-1	208484-1	208484-3

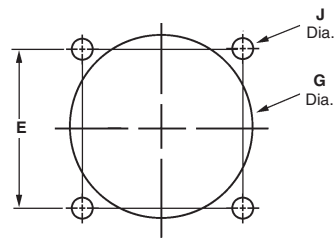

**Recommended Panel Cutout**

**TETRASEALS Ring (Installed in Plugs only)**

The TETRASEALS Ring provides splash-proof sealing between connector metal-shells. It is located behind the plug-shell external keys (under the coupling ring). When mated with a receptacle, the ring is compressed against the inside diameter of the mating end edge of the receptacle shell.

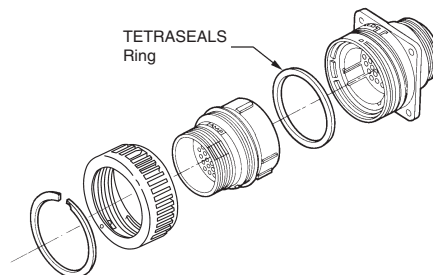

Metal-Shell CPC Series 3

**Metal-Shell CPC Connectors, Series 3, Contact Arrangements**

**Shell Size 22**

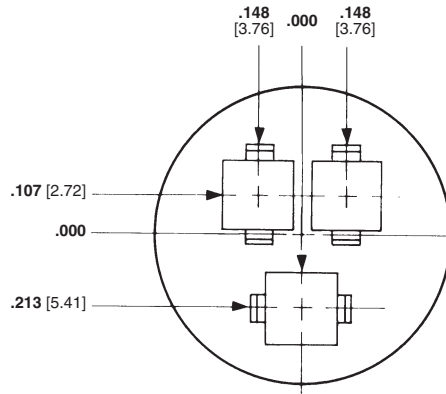

**Arrangement 22-3**  
Max. Wire Ins. Dia. =  $.220$  [ $5.59$ ]

**Shell Size 28**

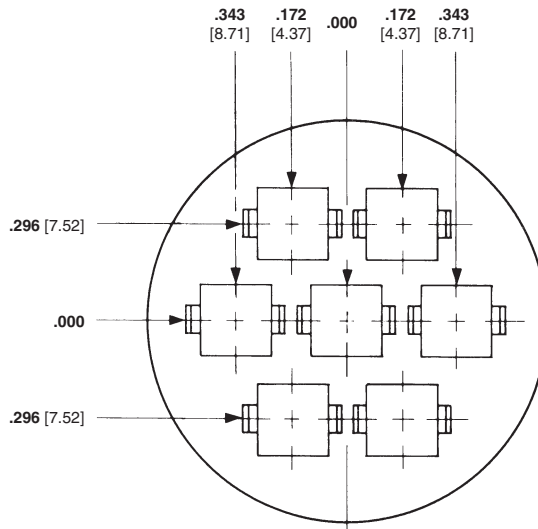

**Arrangement 28-7**  
Max. Wire Ins. Dia. =  $.220$  [ $5.59$ ]

**Note:** Contact arrangements shown are of pin mating face (plug or receptacle). Socket mating face is mirror image.

**Note:** All part numbers are RoHS Compliant.

## Metal-Shell Circular Plastic Connectors, Series 4

### Metal-Shell CPC Connectors, Series 4



Listed part numbers are for connectors only; **contacts must be ordered separately.**

#### Material and Finish

##### Square Flange Receptacle—

**Housing**—Thermoplastic, UL 94V-0 rated, black

**Metal-Shell**—Zinc alloy, plated nickel

**Grooved Pin**—Stainless steel

##### Plug—

**Housing**—Thermoplastic, UL 94V-0 rated, black

**Metal-Shell**—Zinc alloy, plated nickel

**Tetraseal Seal**—Fluorocarbon

**Retainer Rings**—Stainless Steel

**Coupling Ring**—Zinc alloy, plated nickel

### Square Flange Receptacles

(Standard Sex Receptacles accept Type XII Male and Multimatch Pins. Reverse Sex Receptacles accept Type XII Female and Multimatch Sockets.)

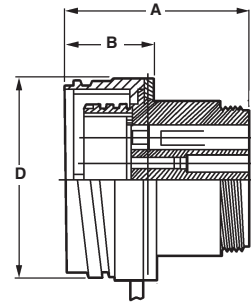
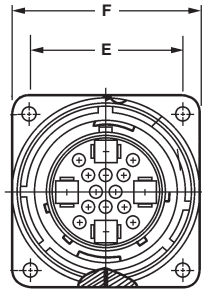

### Plugs

(Standard Sex Plugs accept Type XII Female and Multimatch Sockets. Reverse Sex Plugs accept Type XII Male and Multimatch Pins.)

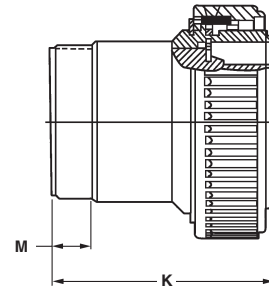
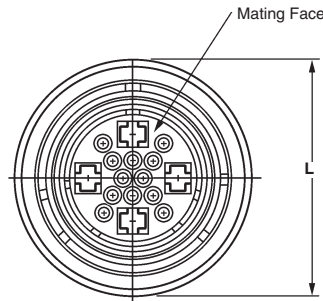

#### Related Product Data

**Contacts**—Pages 17-23 and 34-35

**Contact Arrangement**—Page 69

**Component Dimensions**—Page 70

**Accessories**—Pages 38, 39 and 71

**Performance Characteristics**—Page 6

**Application Tooling**—Pages 76-79

**Technical Documents**—Page 80

Arrangement	Square Flange Receptacle		Plug Part No.		
	Standard Sex	Reverse Sex	without TETRASEALS Ring	with TETRASEALS Ring	Standard Sex
28-16M	208479-1	1776088-1	208478-1	1776089-1	208478-3
28-22M	208481-1	—	208480-1	—	208480-3

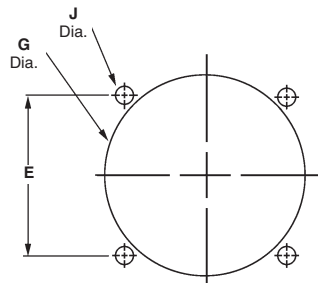

Rear Mount Panel Cutout

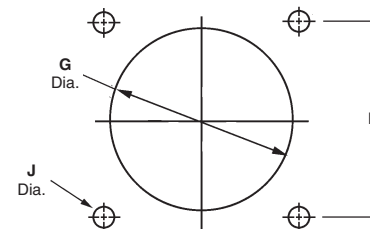

Front Mount Panel Cutout

### TETRASEALS Ring

(Installed in Plugs only)

The TETRASEALS Ring provides splash-proof sealing between connector metal-shells. It is located behind the plug-shell external keys (under the coupling ring). When mated with a receptacle, the ring is compressed against the inside diameter of the mating end edge of the receptacle shell.

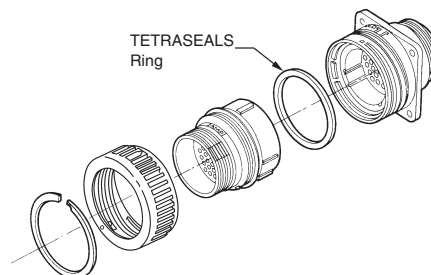

**Metal-Shell CPC Connectors, Series 4, Contact Arrangements**

Shell Size 28

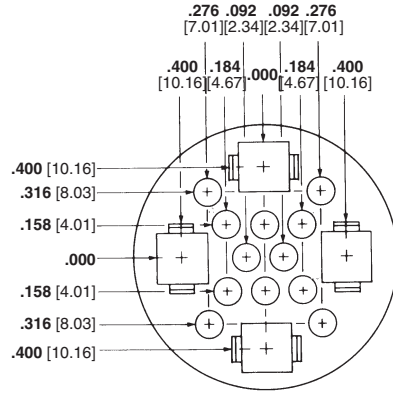

**Arrangement 28-16M**  
Max. Wire Ins. Dia. =  
.150 [3.81] for Multimate Contacts,  
.220 [5.59] for Power Contacts

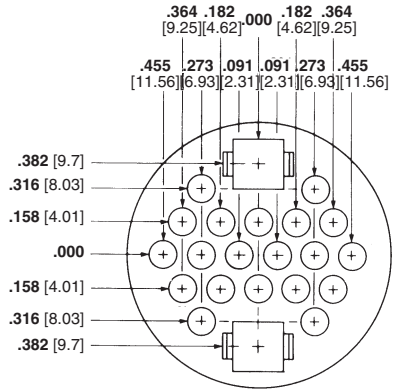

**Arrangement 28-22M**  
Max. Wire Ins. Dia. =  
.150 [3.81] for Multimate Contacts,  
.220 [5.59] for Power Contacts

**Note:** Contact arrangements shown are of pin mating face (plug or receptacle). Socket mating face is mirror image.

**Note:** All part numbers are RoHS Compliant.

**Metal-Shell CPC Connectors Component Dimensions**

**Square Flange Receptacles**

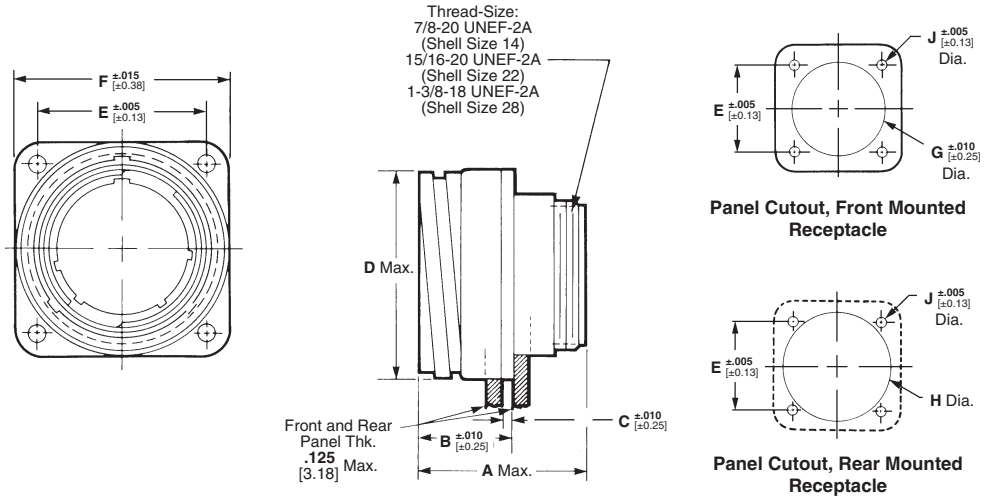

**Plugs**

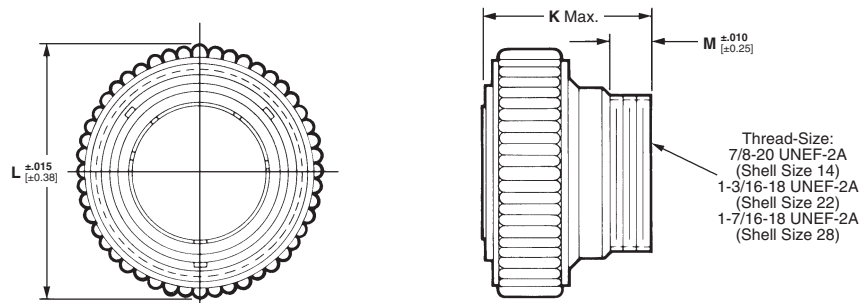

For drawings, technical data or samples, contact your sales engineer or call Technical Support.

**Metal-Shell CPC Component Dimensions**

Series	Arrangement No.	Sex	Dimensions											
			A	B	C	D	E	F	G	H	J	K	L	M
1	14-5	Std.	1.415	.745	.100	1.031	.906	1.185	1.070	1.070	.125	1.400	1.225	.380
		Rev.	35.94	18.92	2.54	26.19	23.01	30.1	27.18	27.18	3.18	35.56	31.12	9.65
	14-7	Std.	1.415	.745	.100	1.031	.906	1.185	1.070	1.070	.125	1.400	1.225	.380
		Rev.	35.94	18.92	2.54	26.19	23.01	30.1	27.18	27.18	3.18	35.56	31.12	9.65
	22-14	Rev.	1.190	.790	.103	1.503	1.250	1.534	1.156	1.554	.120	1.560	1.750	.380
			30.22	20.07	2.62	38.18	31.75	38.96	29.36	39.47	3.05	39.62	44.45	9.65
	22-16	Std.	1.470	.790	.103	1.503	1.250	1.534	1.156	1.554	.120	1.265	1.750	.380
			37.34	20.07	2.62	38.18	31.75	38.96	29.36	39.47	3.05	32.13	44.45	9.65
	28-24	Std.	1.555	.875	.125	1.900	1.562	1.950	1.610	1.970	.145	1.560	2.170	.380
			39.5	22.23	3.18	48.26	39.67	49.53	40.89	50.04	3.68	39.62	55.12	9.65
28-37	Std.	1.540	.875	.125	1.900	1.562	1.950	1.610	1.970	.145	1.560	2.170	.380	
	Rev.	39.12	22.23	3.18	48.26	39.67	49.53	40.89	50.04	3.68	39.62	55.12	9.65	
			1.260	.875	.125	1.900	1.562	1.950	1.610	1.970	.145	1.840	2.170	.380
			31.00	22.23	3.18	48.26	39.67	49.53	40.89	50.04	3.68	46.74	55.12	9.65
2	22-28	Std.	.934	.790	.103	1.503	1.250	1.534	1.156	1.554	.120	1.295	1.750	.380
		Rev.	23.72	20.07	2.62	38.18	31.75	38.96	29.36	39.47	3.05	32.89	44.45	9.65
	28-57	Rev.	1.229	.875	.125	1.900	1.562	1.950	1.610	1.970	.145	1.408	2.170	.380
3	28-63	Std.	1.229	.875	.125	1.900	1.562	1.950	1.610	1.970	.145	1.408	2.170	.380
			31.22	22.22	3.18	48.26	39.67	49.53	40.89	50.04	3.68	35.76	55.12	9.65
3	22-3	Std.	1.755	.790	.103	1.503	1.250	1.534	1.156	1.554	.120	1.805	1.750	.380
		Rev.	44.58	20.07	2.62	38.18	31.75	38.96	29.36	39.47	3.05	45.85	44.45	9.65
4	28-7	Std.	1.825	.875	.125	1.900	1.562	1.950	1.610	1.970	.145	2.125	2.170	.380
		Rev.	46.36	22.22	3.18	48.26	39.67	49.53	40.89	50.04	3.68	53.98	55.12	9.65
4	28-13M	Std.	1.825	.875	.125	1.900	1.562	1.950	1.610	1.970	.145	2.125	2.170	.380
			46.36	22.22	3.18	48.26	39.67	49.53	40.89	50.04	3.68	53.98	55.12	9.65
	28-16M	Std.	1.825	.875	.125	1.900	1.562	1.950	1.610	1.970	.145	2.125	2.170	.380
4	28-22M	Std.	1.825	.875	.125	1.900	1.562	1.950	1.610	1.970	.145	2.125	2.170	.380
			46.36	22.22	3.18	48.26	39.67	49.53	40.89	50.04	3.68	53.98	55.12	9.65

**Note:** All part numbers  
are RoHS Compliant.

## Metal-Shell CPC Connector Accessories

### Cable Clamps

#### Material and Finish

**Body and Clamp Halves**—Zinc alloy,  
nickel plated

**Screws and Washers**—Stainless  
steel

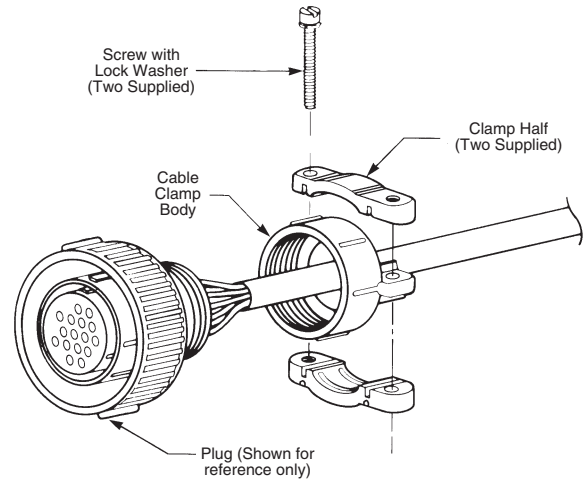
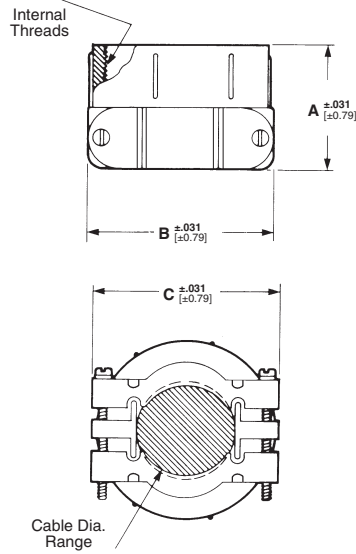

Shell Size	Dimensions			Cable O.D. Range	Thread Size	Part No.
	A	B	C			
14	.938 23.83	1.175 29.85	1.165 29.59	.225-.562 5.71-14.27	7/8-20 UNEF-3B	208945-5
22	.938 23.83	1.432 36.37	1.469 37.31	.325-.750 8.26-19.05	1-3/16-18 UNEF-3B	208945-7
28	1.031 26.19	1.593 40.46	1.688 42.88	.450-.938 11.43-23.83	1-7/16-18 UNEF-3B	208945-8

**Notes:** 1. For Shell Size 22 Receptacle use plastic cable clamp Size 17 (See page 38), for Shell Size 28 Receptacle use plastic cable clamp Size 23 (See pages 38-39). Use Size 14 metal cable clamp for both plug and receptacle Size 14 connectors.  
2. Metal cable clamps (Sizes 22 and 28) are for use with Metal-Shell CPC plugs ONLY.

### Cable Entry Seals

Heat Shrinkable Sealing Boots

Cable entry seals are used with jacketed cable to provide an environmentally sealed wire-to-connector system. They can be used with plugs.

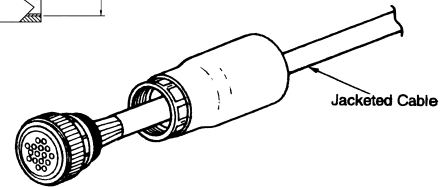
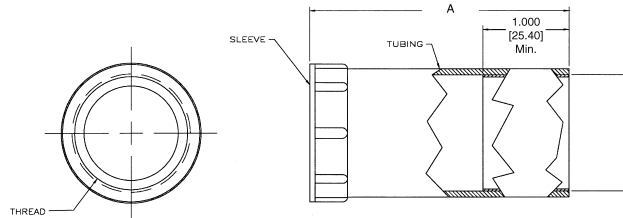

### Thick Wall Boots

#### Material

**Internal Sleeve**—Nylon

**Outer Tubing**—Polyolefin, black

Shell Size	Dimensions		Expanded Wall Thickness	Sealing Range (Dia.)	Max. Recovered Inside Dia.	Part No.
	A	B				
22	3.000	1.250	.070	.550 - 1.250	.500	54012-3
28	76.20	31.75	1.78	13.97 - 31.75	12.70	54012-4

### Protective Cap Assemblies (for Metal-Shell CPC Receptacles Only)

#### Material and Finish

Zinc alloy, nickel plated

Shell Size	Dimensions		Part No.
	A	B	
14	1.225 31.11	.515 13.08	213823-2
22	1.750 44.45	.635 16.13	211903-1
28	2.170 55.12	.635 16.13	211904-1

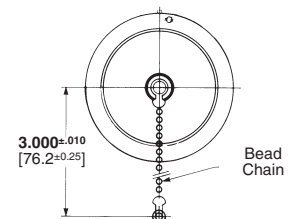
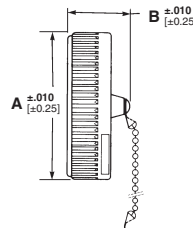

---

## Engineering Notes

---



## Miniature Circular Plastic Connectors (CPC)

### Product Facts

- Two shell sizes: Size 8 (1-4) or Size 11 (5-9) contact positions
- Pre-positioned 1/4 turn coupling ring with positive lock and alignment feature
- Unique contact pattern for each position size helps prevent accidental mating with other position sizes
- Sealed to IP67 (Protected against immersion in water up to 1 meter for 1/2 hour)
- Front or rear jam nut panel mounting
- No assembly required
- Receptacle available in free-hanging or panel mount versions
- Alternate keys available



AMP Miniature Circular Plastic Connectors (CPC) are available in wire-to-wire and wire-to-panel configurations.

Utilizes existing Mini-Universal MATE-N-LOK stamped and formed contacts designed for up to 500 mating cycles when plated with gold or up to 50 cycles with tin plating.

Nylon housings offer good resistance to a wide range of chemical agents while the IP67 sealing helps prevent ingress of dirt or fluids that could have an adverse effect on the contact interface.

Ideal for Industrial, Instrumentation and Transportation applications where size, contact density and environmental exposure are primary concerns.

### Technical Documents

**Product Specification**  
108-2079 Miniature CPC Connectors

### Material and Finish

- Seal, Wire Entry**—Elastomer, yellow or white
- Seal, Peripheral**—Elastomer, gray
- Housing**—Thermoplastic, black or red
- Protector, Seal**—Thermoplastic, natural
- Ring, Coupling**—Thermoplastic, black
- Nut, Jam**—Brass, nickel plated
- Plate, Seal Retention**—Thermoplastic, black

### Cable Assemblies



- Wide variety of custom discrete type cable assemblies, terminated with Terminals and Splices, Soft Shell, and Circular Plastic Connectors and other crimp and mass-terminated products.
- Capability to produce custom overmolded assemblies and insert and injection molding.
- Jacketed cable assemblies and discrete wire: Subminiature-D, SCSI, Circular Plastic, VHDCI, USB and Shielded Data Link
- For more information on our cable assembly capabilities, see our website at [www.tycoelectronics.com/cables](http://www.tycoelectronics.com/cables)



**Miniature Circular Plastic Connectors (CPC) (Continued)**

**Shell Size 8  
(4 Position shown)**

**Receptacle Assembly,  
Panel Mount  
(Order pin contacts separately  
— see page 75)**

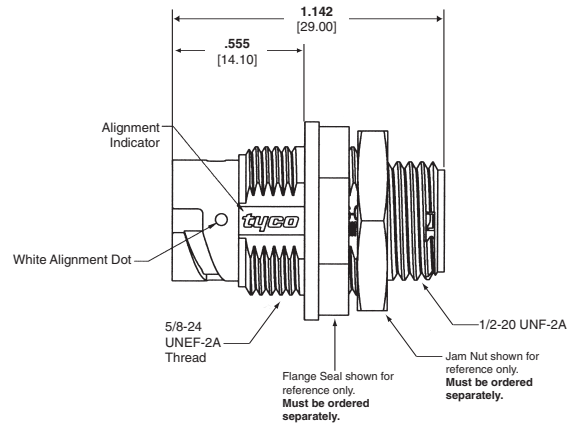
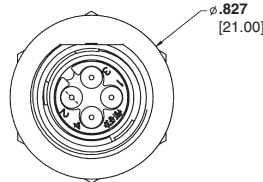

**Receptacle Assembly,  
Free-Hanging  
(Order pin contacts separately  
— see page 75)**

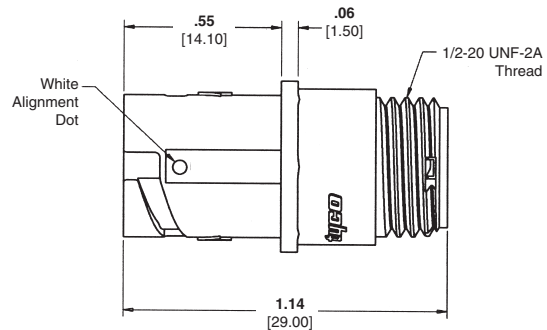
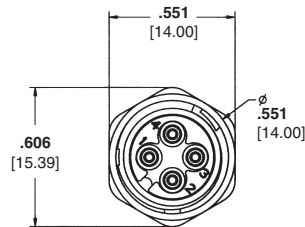

**Plug Assembly  
(Order socket contacts  
separately — see page 75)**

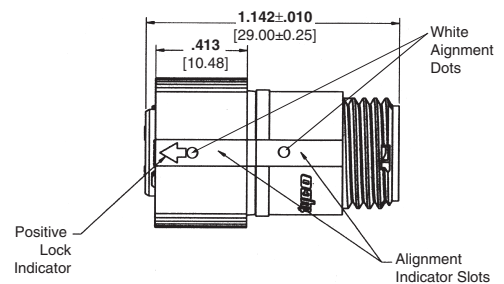
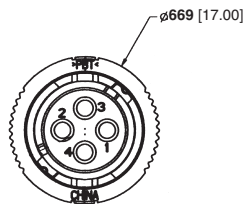

**Related Product Data**

**Part Numbers**—Page 74

**Contacts**—Page 75

**Accessories**—Page 75

**Note:** All part numbers are RoHS Compliant.

**Miniature Circular Plastic Connectors (CPC) (Continued)**

**Shell Size 11 (9 Position shown)**

**Receptacle Assembly, Panel-Mount (Order pin contacts separately — see page 75)**

**Plug Assembly (Order socket contacts separately — see page 75)**

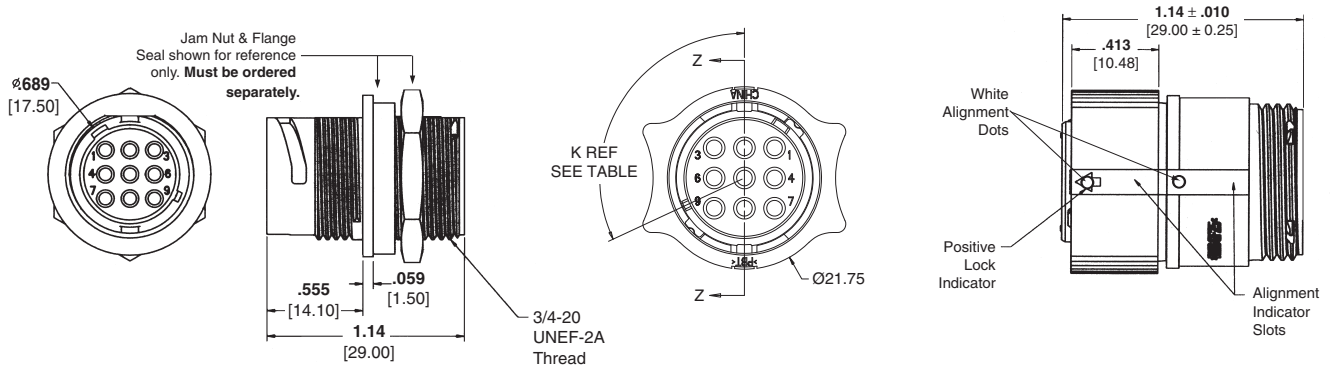

**Receptacle Assembly, Free-Hanging (Order pin contacts separately — see page 75)**

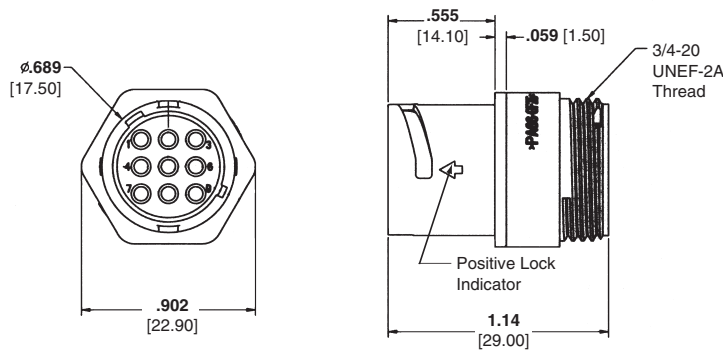

**Housing Part Numbers**

**Standard stocked Part Numbers in BOLD type.**

Shell Size	No. of Pos.	Insulation Diameter Range	Housing Part Numbers		
			Panel Mount Receptacle	Free-Hanging Receptacle	Plug
8	1	.035-.059 [.89-1.5]*	1445539-1	1445526-1	1445536-1
		.059-.110 [1.5-2.39]	1445539-3	1445526-3	1445536-3
8	2	.035-.059 [.89-1.5]*	1445538-1	1445522-1	1445535-1
		.059-.110 [1.5-2.39]	1445538-3	1445522-3	1445535-3
8	3	.035-.059 [.89-1.5]*	1445537-1	1445510-1	1445534-1
		.059-.110 [1.5-2.39]	1445537-3	1445510-3	1445534-3
8	4	.035-.059 [.89-1.5]*	<b>1445421-1</b>	<b>1445389-1</b>	<b>1445390-1</b>
		.059-.110 [1.5-2.39]	<b>1445421-3</b>	<b>1445389-3</b>	<b>1445390-3</b>
11	5	.035-.059 [.89-1.5]*	1445824-1	1445829-1	1445820-1
		.059-.110 [1.5-2.39]	1445824-3	1445829-3	1445820-3
11	6	.035-.059 [.89-1.5]*	1445823-1	1445828-1	1445819-1
		.059-.110 [1.5-2.39]	1445823-3	1445828-3	1445819-3
11	7	.035-.059 [.89-1.5]*	1445822-1	1445827-1	1445818-1
		.059-.110 [1.5-2.39]	1445822-3	1445827-3	1445818-3
11	8	.035-.059 [.89-1.5]*	1445821-1	1445826-1	1445817-1
		.059-.110 [1.5-2.39]	1445821-3	1445826-3	1445817-3
11	9	.035-.059 [.89-1.5]*	<b>1445816-1</b>	<b>1445825-1</b>	<b>1445807-1</b>
		.059-.110 [1.5-2.39]	<b>1445816-3</b>	<b>1445825-3</b>	<b>1445807-3</b>

Note: Alternate keys available (115\* part numbers shown in above chart)  
\*Insertion Tip (Seal Protector) Part No. 1604816-1 recommended for use when inserting socket contacts within this insulation range.

**Note:** All part numbers  
are RoHS Compliant.

## Miniature Circular Plastic Connectors (CPC) (Continued)

### Contacts and Application Tooling

#### Pin (for Receptacles)

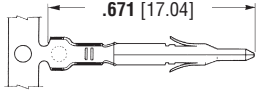

#### Socket (for Plugs)

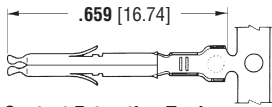

#### Contact Extraction Tool

Part No. 189727-1  
Instruction Sheet 408-4118

#### Contact Insertion Tool

Part No. 455830-1  
Instruction Sheet 408-7984  
(For inserting contacts applied to small diameter wire)

#### Insertion Tip (Seal Protector)

Part No. 1604816-1  
(For inserting socket contacts applied to small diameter wire)

Wire Size Range AWG [mm <sup>2</sup> ]	Ins. Dia. Range	Material and Finish	Contact Part Numbers				HDM Applicator Part No.	Hand Tool Part No.
			Pin		Socket			
			Strip Form	Loose Piece	Strip Form	Loose Piece		
30-26 [.05-.12]	.035-.050 [.889-1.27]	Brass, Pre-tin	770835-1	794059-1	770834-1	794058-1	567418-1 <sup>2</sup> 567418-2 <sup>2</sup> 567418-3 <sup>2</sup>	90717-2
		Phos. Brz., Pre-tin	—	—	770834-4	—		
		Brass, Duplex <sup>1</sup>	1-770835-0	1-794059-0	1-770834-0	1-794058-0		
26-22 [.12-.3]	.047-.069 [1.19-1.75]	Brass, Pre-tin	770901-1	770985-1	770902-1	770986-1	567066-3 <sup>3</sup> 567066-4 <sup>3</sup> 567066-5 <sup>3</sup>	91529-1
		Phos. Brz., Pre-tin	—	—	770902-4	—		
		Brass, Duplex <sup>1</sup>	1-770901-0	1-770985-0	1-770902-0	1-770986-0		
22-18 [.3-.8] or 22 x (2) [.3]	.059-.094 [1.50-2.39] or .067 x (2) [3.38]	Brass, Pre-tin	770903-1	770987-1	770904-1	770988-1	567067-1 <sup>2</sup> 567067-2 <sup>2</sup> 567067-3 <sup>2</sup>	91522-1
		Phos. Brz., Pre-tin	—	—	770904-4	—		
		Brass, Duplex <sup>1</sup>	1-770903-0	1-770987-0	1-770904-0	1-770988-0		
		Phos. Brz., Duplex <sup>1</sup>	—	—	1-770904-1	—		

<sup>1</sup>Duplex Finish – Plated with .000030 [.000762] min. gold in mating area and .000100 [.00254] min. tin in crimping area over .000050 [.00127] min. nickel underplate on entire contact.

<sup>2</sup>HDM Applicator part number ending in -1 is used on AMPOMATOR CLS Machine with T or G Terminators, -2 is used on AMP-O-LECTRIC Model K Machine, -3 is used on AMP-O-LECTRIC Model G Machine. See page 133 for further information.

<sup>3</sup>HDM Applicator part number ending in -3 is used on AMPOMATOR CLS Machine with T or G Terminators, -4 is used on AMP-O-LECTRIC Model K Machine, -5 is used on AMP-O-LECTRIC Model G Machine. See page 133 for further information.

**Note:** All part numbers are RoHS Compliant.

## Accessories (All accessories must be ordered separately.)

### Strain Reliefs

Shell Size	Dimensions		Part Number	
	A	B	Straight	Right-Angle
8	.925 [23.5]	.709 [18.0]	1445730-1	1445771-1
11	1.10 [28.0]	.964 [24.5]	1445856-1	1546746-3 <sup>1</sup> 1546746-4 <sup>2</sup>

<sup>1</sup> Open Style    <sup>2</sup> With Cover

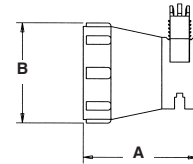

### Heat Shrink Boots

Shell Size	Dimensions		Part Number
	A	B	
8	2.00 [50.8]	.75 [19.0]	1546997-1
11	2.50 [63.5]	1.00 [25.4]	1546921-1



### Flange Seals

Shell Size	Dimensions		Part Number
	A	B	
8	.60 [15.3]	.26 [6.6]	1445420-1
11	.73 [18.5]	.33 [8.5]	1445420-2

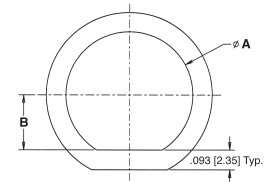

### Jam Nuts

Shell Size	Dimensions		Thread	Part Number
	A	B		
8	.75 [19.0]	.125 [3.2]	5/8-24 UNEF-2B	1604196-1
11	.875 [22.25]	.125 [3.2]	3/4-20 UNEF-2B	1445904-1

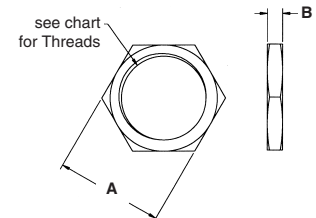

### Dust Caps

Shell Size	Dimensions		Part Number
	A	B	
8	.795 [20.2]	.551 [14.0]	1604089-1
11	.89 [22.6]	.736 [18.7]	1604089-2

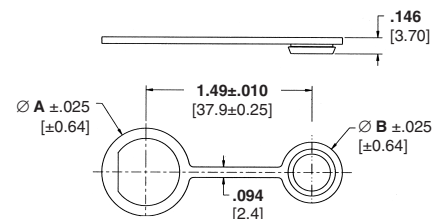

## Application Tooling

### Mechanical Hand Tools for Interchangeable Die Sets

These tools are ideal for small production, prototype and experimental applications. They are used for terminating pin and socket contacts to wire and feature a ratchet device to provide consistently formed crimps.

### SDE (Standard Die Envelope) Die Sets



SDE die sets provide cost-effective flexibility, through many options for a common die-set outline. The SDE die sets can be adapted for use with CERTI-CRIMP hand tools, PRO-CRIMPER III hand tools, the SDE Terminator and the 626 Pneumatic Tool System.

For more information, request Catalog **1654003**.

### PRO-CRIMPER III Hand Tool, Part No. 58495-1



Commercial grade hand tool for crimping various products. Features ratchet control to provide complete crimp cycle. Accepts both pinned- and shouldered-style die sets. Locators are provided with pinned-style die sets for proper contact and wire positioning, and to

help minimize contact rotation and bending during crimping. Approximate weight 1.3 lb [0.60 kg].

For use with Type III+ contacts, see pages 17-19.

For more information, request Catalog **1773380**, Instruction Sheet **408-9930**.

### CERTI-CRIMP Straight Action Hand Tools (SAHT)



Premium grade hand tools. Feature ratchet control to provide complete crimp cycle. Die sets close in a straight line. Include a contact locator and wire stop, plus an insulation crimp

adjustment lever, when applicable. Approximate weight 1.3 lb [0.59 kg]

For Type III+ contacts, see pages 17-19. For more information, request Catalog **65780**.

### CERTI-CRIMP "C" Head Straight Action Hand Tool (SAHT), Part No. 69710-1



Premium grade hand tool. Features ratchet control to provide complete crimp cycle. The interchangeable die sets close in a straight line to minimize contact or terminal rotation during crimping. When applicable, user-assist features such as

a contact or terminal locator and a wire stop, are built into the die set. Approximate weight 1.9 lb [0.86 kg].

For subminiature coaxial contacts, see pages 22-23.

For more information, request Catalog **65780**, Instruction Sheet **408-2095**.

### Electric Machine for Interchangeable Die Sets

### SDE Terminator, Part No. 1490076-2



An electric crimp terminator with compact design features a die set holder that is compatible with all AMP SDE (PRO-CRIMPER III Tool) die sets. Hand- or foot-actuated options are available. CE Approved.

For more information, request Catalog **1654714**.

### Pneumatic Hand Tool for Interchangeable Die Sets

### 626 Pneumatic Tool System



Lightweight, air-operated modular tooling system. Accepts a wide variety of interchangeable heads for crimping various types of contacts, terminals and splices onto wires ranging 6-26 AWG [13-0.12 mm<sup>2</sup>], plus coaxial and fiber optic cable. Available with either

hand- or foot-actuation switch. Optional ratchet control available to provide complete crimp cycle.

For subminiature coaxial contacts, see pages 22-23.

For more information, request Catalog **124208**.

**Application Tooling** (Continued)

**Crimp Machines**

**AMP-O-LECTRIC Model "G" Terminating Machines, Part Nos. 354500-1, -9, -11**



Semiautomatic bench machines for crimping reeled terminals and contacts, featuring a quiet and reliable direct motor drive, microprocessor controls for ease of setup and operation, and guarding and lighting designed for operator convenience and safety. All models are equipped with either manual or automatic precision adjustment of crimp height. Machine-mounted sensors are available for crimp quality monitoring using conventional miniature-style applicators.

For more information, request Catalog **1654956-2**, Video **198116**, Catalog **82275 [Crimp Quality Monitor (CQM)]**, Video **198094**.

**Note:** New Stripping Module available, see page 79.

**AMP-TAPETRONIC Machine, Part No. 69875**

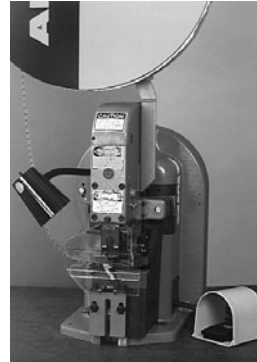

AMP-O-LECTRIC Model "K" Terminating Machine with a permanently-mounted applicator that accepts interchangeable die sets to apply a variety of tape-mounted terminals and splices. Many of the die sets can also be used in AMP-O-LECTRIC Terminating Machines with a tape applicator.

For more information, contact Tyco Electronics.

**Crimp Quality Monitor (CQM) Part No. 1320420-2**



The unique system provides 100% on-the-fly crimp inspection. It measures the crimp height of each termination, and evaluates the quality of each crimp. If a crimp is questionable, the monitor alerts the operator with both visual and audible alarms. It also provides ports for printing and networking. When used with AMP-O-LECTRIC Model "G" Termination Machines, the monitor is mounted to the machine. When used with AMPOMATOR CLS IV Lead Making Machines, it is integrated into the machine's operating system.

For more information, request Catalog **82275**.

**AMP 3K/40 and AMP 5K/40 Terminating Machines**



- **3,000 lb [1361 kg] max. crimp force (AMP 3K/40); 5,000 lb [2268 kg] max. crimp force (AMP 5K/40)**
- **Toolless removal of applicators and guards**
- **Jog capability**
- **Quiet, fast operation — 80/76 dBA and cycle time less than 0.400 seconds**
- **Accepts Heavy Duty Mini style applicators**
- **Wide range of optional equipment such as toolless precision crimp height adjust, batch counter, CQM capability and work light**

The AMP 3K/40 and AMP 5K/40 Terminators are designed for customers that require the increased output and quality of a semiautomatic machine at a competitive price. By incorporating the most commonly requested features as standard and offering a long list of optional equipment, these terminators offer flexibility to meet the specific needs of various applications at the lowest possible cost.

For more information, request Catalog **1654956-2**.

**Note:** New Stripping Module available, see page 79.

**System III Applicator**



The System III Applicator introduces several new technologies into the applicator including a precision servo-electric motorized feeding system, a built-in data module for storing terminal crimp and set-up information, a precision fit round ram, and a newly designed terminal depressor. It still utilizes the proven quality of the HD-M crimper and anvil tooling.

For more information, request Catalog **1654956-8**

## Application Tooling (Continued)

### Lead Makers

#### Komax gamma 333 PC Lead-Making Machine

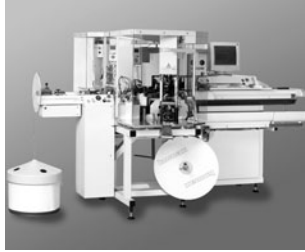

This fully-automatic, PC-controlled leadmaker can be equipped with up to three processing stations enabling the crimping of both ends of the wire, double-crimp connections with three different contacts, single-ended seal applications, tinning or ink-jet marking. Features include ultra-short conversions times, easy-to-use graphic-based TopWin interface with multiple-language capability, crimp force analyzer with statistical analysis, seal monitoring, and integrated good/bad sorting.

For more information, request Catalog **1307901**.

#### AMPOMATOR System III Leadmaker



The AMPOMATOR System III Leadmaker is designed for the demands of low-volume/high mix manufacturing and precision quality. This leadmaker combines the best wire processing capabilities with new technologies in terminal feeding and machine set-up found in the System III Applicator to offer significant advantages for higher throughput and efficiencies.

See catalog **1654956-5** for more information.

#### AMPOMATOR CLS IV+ Lead-Making Machines, Part Nos. 356500-1, -2; 1213400-1, -2



Fully-automatic machines that measure, cut, strip and terminate single leads. Microprocessor-controlled, and programmed and operated using an easy-to-follow, menu-driven touch-screen. Features include direct-drive terminating units with precision crimp height adjustment, fully programmable setups, wire runout and splice detection, and motorized pre-feed with wire straightener. Crimp quality monitoring is also available.

For more information, request Catalog **124324**, Video **198142** (NTSC), **199609** (PAL).

#### Komax 433-S alpha Lead-Making Machine

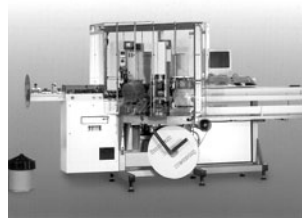

The 433-S alpha offers maximum flexibility for applying seals to one or both ends of the wire with the corresponding terminal. When equipped with the mci 711 crimp terminator and mci 761 seal applicator, the fully-automated 433-S alpha forms a highly compact system with optimum accessibility. Dynamic servo-drives provide fine travel settings on all motor axes and the wire straightening unit with quick-release lock and automatic lead-in feature reduces wire changeover time. The TopWin software provides for fast, simple data input.

For more information, request Catalog **1307801**.

### Applicators

#### End-Feed Heavy-Duty Miniature Applicators (coded HDM)



Interchangeable applicators for crimping products reeled end-to-end (primarily open-barrel terminals). Used in bench and lead-making machines; most designs can be used, or adapted for use with minor tooling changes, dial-in settings for different wire sizes and insulation diameters. Mechanical or air-powered feed systems, depending on the product applied.

For more information, request Catalog **296393-2** and Instruction Sheet **408-8039**.

#### EDGE Applicator Counter



The new EDGE counter tracks wearable tool usage for the most effective maintenance planning. The completely electronic counter, with clear LCD display, indicates cycles since installation. By performing maintenance at measured intervals with pre-set limits, operators avoid breakdowns and rejects caused by tool wear or mis-adjustment. A wireless interface transfers counters to a PC running the optional Edge Counter Software Pack.

The EDGE is standard on all new applicators and can be retrofitted to most existing Tyco Electronics applicators. See catalog **1773385** for more information.

**Application Tooling** (Continued)

**Side-Feed Heavy-Duty Miniature Applicators (coded HDM)**



Interchangeable applicators for crimping products reeled side-by-side on single or dual carrier strips (primarily closed-barrel terminals and open-barrel contacts). Similar design as the end-feed version. All side-feed applicators include a wire stop to help correctly position the wire end in the crimping target area. For more information, request Catalog **296393-2** and Instruction Sheet **408-8040**.

**Stripping Module (for the AMP 3K/40 and AMP 5K/40 Terminating Machines and AMP-O-LECTRIC Model "G" Terminator on page 77)**

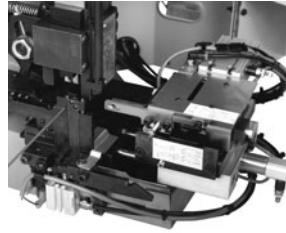

The combination of the Stripping Module with the AMP 3K/40 and AMP 5K/40 Terminating Machines or the AMP-O-LECTRIC Model "G" Terminator provides an economic and proficient method of stripping the wire and crimping terminals on the same machine. The module accepts End- and Side-Feed HDM Applicators (32-14 AWG) and operates in three modes: crimp only, strip only, or strip and crimp. It can be installed on existing machines in the field or purchased as one unit from the factory.

For more information, request Catalog **1309085**.

**Stripper-Crimper Applicators (coded SCA)**



Interchangeable applicators for crimping products in AMP-O-MATIC Stripper-Crimper Machines. Consist of separate ram and lower tooling assemblies. Similar dial-in settings for different wire sizes and insulation diameters as HDM applicators. Available with sensors for use with the Crimp Quality Monitor.

For more information, request Catalog **65004 (AMP-O-MATIC Stripper-Crimper Machines)**, Catalog **82275 [Crimp Quality Monitor (CQM)]**.

**Komax Delta 60 Wire Stripper**



The semiautomatic Delta 60 is designed to strip single- and multiple-pole conductors with pull-off lengths of .984 [25] or 3.78 [96]. Thanks to the electric drive and non-pneumatic design, the device is quick and quiet in operation and can be utilized virtually anywhere. The Delta 60 can desheath or strip stranded conductors and multiple wire cables with external diameters of up to .433 [11].

See catalog **1654956** for more information.

**Cosmic 30M Wire Stripping Machine, 5-528367-0**



The Cosmic 30M is a high precision, high speed electrical wire stripper that is very easy to operate. It's equipped with a four blade system and an optional gripper for more difficult wires. There is a digital display for the wire diameter that can be set at 0.01 mm increments.

See catalog **1773385-2** for more information.

**Stripper-Crimper Machines**

**AMP-O-MATIC Stripper-Crimper Machines, Part Nos. 1320895-1, -2**



Semiautomatic bench crimping machines that also strip the wire, and are therefore used for terminating jacketed cable. Feature manual precision adjustment of crimp height, keyed strip blades for faster, more accurate setups, and an efficient scrap removal system. All adjustments can be made from the front of the machines without special tools. Available with crimp quality monitoring.

For more information, request Catalog **65004**, Video **198075**, Catalog **82275 [Crimp Quality Monitor (CQM)]**, Video **198094**.

**Cosmic 927R Micro-Cable Stripper**



The compact, lightweight, benchtop Cosmic 927R was designed and developed to reliably strip various insulation materials and micro-cable. From conductor diameter 36 to 10 AWG, the stripping diameter display can be set to within 0.1 mm increments.

See catalog **1773385-4** for more information.

## Technical Documents

Various technical documents are available for your use:

**Product Specifications** describe technical performance characteristics and verification tests. They are intended for the Design, Component and Quality Engineer.

- 108-1579** Sealed CPC Connectors with Removable Contacts
- 108-2079** Miniature CPC Connectors
- 108-10024** CPC Connectors
- 108-10024-2** (Series 1)
- 108-10024-3** (Series 2)
- 108-10024-4** (Series 3 & 4)
- 108-10037** Contacts, Type XII
- 108-10040** Metal-Shell CPC Connectors
- 108-10042** Contacts, Type III +
- 108-40005** Contacts, Size 20 DF

**Application Specifications** describe requirements for using the product in its intended application and/or crimping information. They are intended for the Packaging and Design Engineer and the Machine Setup Person.

- 114-10000** Contacts, Size 20 DF
- 114-10004** Contacts, Type III +
- 114-10005** Contacts, Type XII
- 114-10038** CPC Connectors

**Instruction Sheets** provide instructions for assembling or applying the product. They are intended for the Manufacturing Assembler or Operator.

- 408-4317** Two-Piece Sealed CPC Connectors
- 408-6641** Metal-Shell CPC Connectors
- 408-7582** Accessories for CPC Connectors
- 408-7593** CPC Connectors
- 408-7901** Application and Maintenance for AMP Hand Crimp Tool
- 408-8416** CPC Right-Angle Cable Clamp Assembly

### Application Tooling/Instruction Sheet Cross Reference

Tool Part No.	Instruction Sheet	Tool Part No.	Instruction Sheet
58495-1	408-9819	91285-1	408-9404
69710-1	408-2095	305183	408-1216
91019-3	408-7276	318813-1	408-4374
91067-2	408-7508		



## Part Number Index

**Note:** This part number index lists all cataloged parts by base number only. Complete part numbers (with prefixes and/or suffixes) are shown on the pages indicated.

Part Number	Page
51565	22,23
54010	52
54011	52
54012	52,71
54123	52
66098	17
66099	17
66100	17
66101	17
66102	17
66103	17
66104	17
66105	17
66106	17
66107	17
66108	17
66109	17
66180	20
66181	20
66182	20
66183	20
66253	34
66254	34
66255	34
66256	34
66259	34
66260	34
66261	34
66262	34
66331	17
66332	17
66358	17,18
66359	17,18
66360	17,18
66361	17,18
66393	17
66394	17
66399	17
66400	17
66405	17
66406	17
66424	17
66425	17
66428	17
66429	17
66504	29
66505	29
66506	29
66507	29
66563	17,57
66564	17
66565	17,57
66566	17
66569	30
66570	30
66597	17,18
66598	17,18,57
66600	17
66601	17,18,57

Part Number	Page
66602	17,18
66740	34
66741	34
81665	44,48,49,50,51
164159	19
164160	19
164161	19
164162	19
164163	19
164164	19
193844	19
193846	19
193990	35
193991	35
200333	21
200336	21
200821	42
201328	21
201330	21
201332	21
201334	21
201568	21
201570	21
201578	21
201580	21
201611	21
201613	21
202236	20
202237	20
202410	21
202411	21
202507	21
202508	21
202725	21
202726	21
204219	21
205089	30
205090	30
205838	26,28
205839	26
205840	26
205841	26
205842	26
205843	26
206036	10,33,35,50
206037	10,14,16,33,35,50
206038	26
206039	26
206043	10,50
206044	10,15,50
206060	10,14,15,50
206061	10,50
206062	38
206070	38,48,49,56
206125	28
206126	28
206127	28
206136	33
206137	33
206138	38
206150	10,15,16,50
206151	10,50
206152	26
206153	10,50
206207	33

Part Number	Page
206226	33
206227	33
206304	53
206305	10,15,50
206306	10,50
206322	38,48,49,56
206358	38
206404	14
206425	33
206426	33
206429	10,15,50
206430	10,50
206433	26
206434	26
206437	26
206438	26
206455	27
206458	28
206460	28
206485	26
206486	26
206508	42
206509	42
206512	38,53
206516	14
206518	14
206552	14
206554	14
206612	37
206613	37
206705	10,50
206708	10,15,50
206837	10,15,16,50
206838	10,50
206852	27
206903	52
206934	12
206966	38
207008	38
207052	53
207055	40
207216	27
207241	41
207292	13
207299	40
207303	12
207369	27
207387	41
207445	52
207446	52
207485	37
207486	37
207489	41
207490	41
207597	42
207774	39
207825	12
207890	13
208130	10
208131	10,50
208132	12
208223	12
208224	13
208283	13
208337	44

Part Number	Page
208338	44
208457	59
208459	59
208470	59
208471	59
208472	60
208473	60
208474	63
208475	63
208476	62
208477	62
208478	68
208479	68
208480	68
208481	68
208482	65
208483	65
208484	66
208485	66
208486	60
208487	60
208488	59
208489	59
208490	62
208491	62
208492	63
208493	63
208494	65
208495	65
208496	66
208497	66
208652	52
208657	27
208680	52
208714	59
208715	59
208716	60
208717	60
208718	59
208719	59
208720	60
208721	60
208800	52
208945	71
211102	10
211103	10
211398	11
211399	11,15,16,50
211400	11,15
211401	11,50
211766	11,15
211767	11
211768	11,15
211769	11
211770	11,15
211771	11
211772	11,15
211773	11
211824	37
211825	37
211839	10
211870	52
211903	71
211904	71
212618	21

**Part Number Index** (Continued)

Part Number	Page	Part Number	Page	Part Number	Page	Part Number	Page
213485	52	225088	22	796405	15	1658538	29
213570	56	226537	22,23	796406	15	1658539	26
213571	56	332056	22	796407	15	1658540	29
213581	33	332057	22,23	796409	15	1658543	29
213588	12	539972	19	796433	12	1658544	29
213603	57	745253	29	796435	15	1776088	68
213605	57	745254	29	796437	10	1776089	68
213650	56	770834	75	796439	11	1776903	16
213651	56	770835	75	796449	10	1776904	16
213652	56	770901	75	796450	11	1776905	16
213667	57	770902	75	796497	15	1776906	16
213668	57	770903	75	796500	15	5019024	38
213671	57	770904	75	796501	15	5066682	29
213729	13	770834	75	796502	15	5066683	29
213780	12	770985	75	796964	19		
213781	13	770986	75	796966	19		
213782	12	770987	75	969789	54		
213798	12	770988	75	969803	54		
213810	10,11,26,33,48,49	787610	10	969807	54		
213811	10,26	788085	17	969809	54		
213812	10,11,26,33,37	788088	17	969811	54		
213813	10,11	788130	13	969813	54		
213823	71	788153	44	969817	54		
213825	13	788154	44	1445389	75		
213826	13	788155	44	1445390	75		
213827	13	788157	44	1445420	75		
213828	13	788158	44	1445421	75		
213841	47	788159	44	1445510	75		
213843	47	788188	45	1445522	75		
213845	47	788189	45	1445526	75		
213847	47	794058	75	1445534	75		
213848	10	795059	75	1445535	75		
213849	10	796075	44	1445536	75		
213850	10	796094	44	1445537	75		
213851	10	796095	44	1445538	75		
213852	11	796096	44	1445539	75		
213853	11	796112	45	1445730	74		
213854	12	796188	44	1445771	75		
213855	12	796190	44	1445807	75		
213856	13	796203	45	1445816	75		
213857	12	796207	45	1445817	75		
213858	13	796257	54	1445818	75		
213859	12	796260	54	1445819	75		
213860	10	796271	44	1445820	75		
213862	10	796272	44	1445821	75		
213864	10	796273	44	1445822	75		
213866	10	796274	44	1445823	75		
213868	11	796275	44	1445834	75		
213870	11	796276	44	1445825	75		
213889	48	796286	44	1445826	75		
213890	48	796287	44	1445827	75		
213893	49	796288	44	1445828	75		
213894	49	796291	44	1445829	75		
213899	48,51	796329	27	1445856	74		
213900	49,51	796330	45	1445904	75		
213902	48,49	796332	45	1546347	39		
213904	48,49	796348	15	1546348	39		
213905	48	796375	15	1546349	39		
213906	49	796379	39	1546350	39		
213919	51	796380	39	1546746	75		
213920	51	796381	39	1546921	75		
213925	51	796382	39	1546997	75		
213926	51	796387	15	1604089	75		
213933	52	796403	15	1604196	75		
213982	39	796404	15	1658537	29		

## Tooling Part Number Index

Part Number	Page
58448	29
58495	17,19,80
58541	21
69656	23
69690	23
69710	22,23,34,47,76,80
69875	21,77
90136	21
90140	34
90145	34
90225	17
90230	21
90231	21
90249	21
90250	21
90716	17
90717	75
90758	75
90759	75
90870	75
91002	17
91019	34,80
91067	80
91285	29,80
91503	29
91505	17,19
91515	17,19
91519	17,18

Part Number	Page
91521	17,18,57
91522	75
91523	17,19
91525	29
91529	75
91538	21
91539	21,22
91542	17,57
91549	29
91911	23
189721	17,18,19,21,22, 23,29,34,47,57
189722	17,18,19,21,22, 23,29,34,47,57
189727	75
189928	17,18,19,21,22, 23,29,34,47,57
200893	17,21
217201	17,18,19,29,57
224155	35
305183	17,19,20,21,22,23,57,80
318161	21,22,23,34,47
318813	47,80
354500	47,77
354940	23
356114	35
356119	35
356304	17,18,19,21,22,23, 29,34,47,57

Part Number	Page
356500	78
356611	47
356612	47
455830	75
466321	17
466323	17,19
466324	17
466325	17
466326	17,18
466383	17
466422	29
466423	29
466585	17
466598	17
466741	19
466758	29
466900	29
466901	29
466906	17
466907	17,19
466908	17
466923	17,18
466942	17
466958	17,18,57
466963	29
466968	29
466979	17
567021	34
567036	29

Part Number	Page
567066	75
567067	75
567363	17,57
567364	17,18,57
567418	75
567455	34
567801	29
567804	29
567834	57
567849	29
567867	17
567947	17
601966	30
601967	19,21,22
680114	19
680195	47
680197	47
680602	17
725840	19
1016002	29
1016015	29
1213400	78
1320420	77
1320895	79
1490076	76
1604816	75

## Cross Reference: Non-Compliant to RoHS Compliant Part Numbers

Non-Compliant Part No.	RoHS Compliant Part No.	Page
19024-1	5019024-1	38
19024-2	5019024-2	38
19024-3	5019024-3	38
19024-4	5019024-4	38
19024-5	5019024-5	38
45098	91539-1	21,22
66098-2	1-66098-9	17
66098-7	1-66098-8	17
66099-2	1-66099-5	17
66100-7	1-66100-9	17
66101-2	1-66101-9	17
66102-7	2-66102-5	17
66103-2	1-66103-8	17
66104-7	3-66104-0	17
2-66104-5	3-66104-0	17
66105-2	1-66105-9	17
66106-6	1-66106-5	17
66107-2	1-66107-1	17
66108-6	1-66108-5	17
66109-2	1-66109-7	17
66331-5	1-66331-4	17
66332-5	1-66332-4	17
66358-6	1-66358-6	17,18
1-66358-2	1-66358-8	17,18
1-66358-4	1-66358-6	17,18
2-66358-0	2-66358-1	17,18
66359-6	1-66359-4	17
1-66359-1	1-66359-5	17,18
1-66359-7	1-66359-9	17,18
66360-2	1-66360-2	17,18
1-66360-5	1-66360-6	17,18
66361-2	1-66361-2	17,18
1-66361-5	1-66361-6	17,18
66399-1	1-66399-0	17
66400-1	1-66400-0	17
66424-6	1-66424-1	17
66425-6	1-66425-2	17
5-66504-6	1658537-1	29
5-66504-7	1658537-2	29
5-66504-9	1658537-3	29
6-66504-0	1658537-4	29
5-66505-0	1658538-3	29
6-66505-0	1658538-2	29
6-66505-2	66505-9	29
2-66506-4	1658539-1	29
2-66506-5	1658539-2	29
5-66506-7	1658539-3	29
5-66506-9	1658539-4	29
3-66507-0	1658540-4	29
3-66507-1	1658540-1	29

Non-Compliant Part No.	RoHS Compliant Part No.	Page
5-66507-7	1658540-5	29
5-66507-9	1658540-2	29
66563-6	1-66563-1	17,57
66564-6	1-66564-2	17
66565-2	66565-7	17,57
66566-2	66566-7	17
66597-1	66597-8	17,18
66598-1	66598-9	17,18,57
66598-7	1-66598-0 1-66598-4	17,18,57
66601-1	66601-9	17,18,57
66602-1	66602-8	17,18
66682-6	5066682-6	29
66682-9	5066682-9	29
1-66682-1	66682-4	29
66683-7	5066683-7	29
1-66683-0	1-5066683-0	29
202236-1	202236-7	20
202236-2	202236-5	20
202237-1	202237-7	20
202237-2	202237-5	20
206062-3	1-206062-4	38
206062-4	1-206062-7	38
206070-1	206070-8	38,48,49,56
206070-3	1-206070-0	38,48,49,56
206138-1	206138-8	38
206138-2	1-206138-0	38
206322-1	206322-9	38,48,49,56
206322-2	1-206322-0	38,48,49,56
206358-1	206358-5	38
206358-2	206358-6	38
206455-1	1-206455-1	27
206455-2	1-206455-2	27
206512-1	206512-5	38,53
206512-2	206512-6	38,53
206852-1	1-206852-1	27
206852-2	1-206852-2	27
206934-1	1-206934-1	12
206934-6	1-206934-8	12
206934-7	1-206934-9	12
206934-9	1-206934-7	12
206966-1	206966-7	38
206966-2	206966-9	38
207008-1	207008-5	38
207008-2	207008-6	38
207216-2	1-207216-6	27
207216-8	1-207216-7	27
207303-1	1-207303-5	12
207303-3	1-207303-3	12
1-207303-1	1-207303-4	12
207369-1	1-207369-1	27

Non-Compliant Part No.	RoHS Compliant Part No.	Page
207369-3	1-207369-3	27
207774-1	207774-3	39
207774-2	207774-4	39
207825-1	207825-9	12
207890-1	207890-2	13
208132-1	208132-2	12
208223-1	208223-9	12
208223-3	1-208223-0	12
208224-1	2-208224-1	13
208224-2	1-208224-2	13
208283-1	208283-4	13
208657-1	1-208657-1	27
208657-5	1-208657-0	27
213588-1	213588-2	12
213603-1	213603-5	57
213603-2	213603-6	57
213605-1	213605-7	57
213729-1	213729-9	13
213729-2	213729-6	13
213729-4	213729-8	13
213780-1	213780-2	12
213781-1	213781-9	13
213782-1	213782-4	12
213798-1	213798-3	12
213825-1	1-213825-7	13
213826-1	1-213826-1	13
213827-1	213827-8	13
213828-1	1-213828-6	13
213854-1	213854-3	12
213855-1	213855-4	12
213855-2	213855-3	12
213856-1	213856-4	13
213857-1	213857-2	12
213858-1	213858-3	13
213859-1	213859-2	12
213902-1	213902-3	48,49
213904-1	213904-3	48,49
225088-1	5-225088-1	22
225088-3	5-225088-3	22
466598-1	466598-2	17
1-745253-1	1658543-3	29
1-745253-3	1-745253-6	29
1-745253-4	1658543-2	29
1-745253-6	1658543-1	29
1-745254-1	1658544-3	29
1-745254-3	1-745254-6	29
1-745254-4	1658544-2	29
1-745254-6	1658544-1	29
770834-3	1-770834-0	75
770834-6	1-770834-1	75
770835-3	1-770835-0	75

Non-Compliant Part No.	RoHS Compliant Part No.	Page
770901-3	1-770901-0	75
770902-3	1-770902-0	75
770902-6	1-770902-1	75
770903-3	1-770903-0	75
770904-3	1-770904-0	75
770904-6	1-770904-1	75
770985-3	1-770985-0	75
770986-3	1-770986-0	75
770987-3	1-770987-0	75
770988-3	1-770988-0	75
788130-1	1-788130-1	13
794058-3	1-794058-0	75
794059-3	1-794059-0	75
796329-1	1-796329-1	27
796348-1	796348-2	16
796375-1	1-796375-1	16
796375-2	1-796375-2	16
796379-1	796379-2	39
796380-1	796380-2	39
796381-1	796381-2	39
796382-1	796382-2	39
796387-1	1-796387-1	16
796387-2	1-796387-2	16
796403-1	1-796403-1	16
796403-2	1-796403-2	16
796404-1	1-796404-1	16
796405-1	1-796405-1	16
796406-1	1-796406-1	16
796407-1	1-796407-1	16
796409-1	1-796409-1	16
796433-1	1-796433-1	12
796435-1	1-796435-1	16
796435-2	1-796435-2	16
796497-1	1-796497-1	16
796500-1	1-796500-1	16
796501-1	1-796501-1	16
796502-1	1-796502-1	16
1490076-1	1490076-2	76
1546347-1	1546347-2	39
1546348-1	1546348-2	39
1546349-1	1546349-2	39
1546350-1	1546350-2	39
1546746-1	1546746-3	75
1546746-2	1546746-4	75

## Americas

**Argentina** – Buenos Aires  
Phone: +54-11-4733-2200  
Fax: +54-11-4733-2211

**Brasil** – São Paulo  
Phone: +55-11-3611-1311  
Fax: +55-11-3611-0397

**Canada** – Toronto  
Phone: +905-475-6222  
Fax: +905-474-5520  
**Product Information Center:  
(Technical Support)**

Phone: +905-470-4425  
Fax: +905-474-5525

**Colombia** – Bogota  
Phone: +57-1-231-9398  
Fax: +57-1-660-0206

**Mexico** – Mexico City  
Phone: +52-55-1106-0800  
+01-800-733-8926  
Fax: +52-55-1106-0901

**United States** – Harrisburg, PA  
Phone: +717-564-0100  
Fax: +717-986-7575  
**Product Information Center:  
(Technical Support)**  
Phone: +800-522-6752  
Fax: +717-986-7575

**For Latin/South American  
Countries not shown**  
Phone: +54-11-4733-2015  
Fax: +54-11-4733-2083

## Asia/Pacific

**Australia** – Sydney  
Phone: +61-2-9554-2600  
Fax: +61-2-9502-2556

**Product Information Center:  
(Technical Support)**  
Phone: +61-2-9840-8200  
Fax: +61-2-9634-6188

**India** – Bangalore  
Phone: +91-80-285-40800  
Fax: +91-80-285-40820

**Indonesia** – Jakarta  
Phone: +65-6482-0311  
Fax: +65-6482-1012

**Japan** – Toyko  
Phone: +81-44-844-8111  
Fax: +81-44-812-3207  
**Raychem & Identification Products**

Phone: +81-44-844-8183  
Fax: +81-44-844-8184

**Product Information Center:  
(Technical Support)**  
Phone: +81-44-844-8013  
Fax: +81-44-812-3200

**Korea** – Seoul  
Phone: +82-2-3415-4500  
Fax: +82-2-3486-3810

**Malaysia** – Kuala Lumpur  
Phone: +60-3-78053055  
Fax: +60-3-78053066

**New Zealand** – Auckland  
Phone: +64-9-634-4580  
Fax: +64-9-634-4586

**Philippines** – Makati City  
Phone: +632-848-0171  
Fax: +632-867-8661

**People's Republic of China**  
Hong Kong  
Phone: +852-2735-1628  
Fax: +852-2735-0243

Shanghai  
Phone: +86-21-2407-1588  
Fax: +86-21-2407-1599

Taiwan – Taipei  
Phone: +886-2-8768-2788  
Fax: +886-2-8768-2268

**Singapore** – Singapore  
Phone: +65-6482-0311  
Fax: +65-6482-1012

**Raychem Products**  
Phone: +65-4866-151  
Fax: +65-6545-514  
**Identification Products**  
Phone: +65 (0) 6482-0311  
Fax: +65 (0) 6481-5514

**Thailand** – Bangkok  
Phone: +66-2-955-0500  
Fax: +66-2-955-0505

**Vietnam and Indochina** –  
Ho Chi Minh City  
Phone: +84-8 930-5546  
Fax: +84-8 930-3443

## Europe/Middle East/Africa

**Austria** – Vienna  
Phone: +43-1 90 5 60-0  
Fax: +43-1 90 5 60-1333

**Belgium** – Kessel-Lo  
Phone: +32-16-35-23-00  
Fax: +32-16-35-23-52

**Bulgaria** – Sofia  
Phone: +359-2-971-2152  
Fax: +359-2-971-2153

**Czech Republic** – Kurim  
Phone: +420-5-41-162-111  
Fax: +420-5-41-162-223

**Denmark** – Glostrup  
Phone: +45-43-480-452  
Fax: +45-43-441-414

**Egypt** – Cairo  
Phone: +20-2-29 04 281  
Fax: +20-2-41 92 334

**Estonia** – Tartu  
Phone: +372-5138-274  
Fax: +372-7400-779

**Finland** – Helsinki  
Phone: +358-95-12-34-20  
Fax: +358-95-12-34-250

**France** – Cergy-Pontoise  
Phone: +33-1-3420-8888  
Fax: +33-1-3420-8600  
**Product Information Center:  
(Technical Support)**  
Phone: +33-1-3420-8943  
Fax: +33-1-3420-8623

**Germany** – Bensheim  
Phone: +49-6251-133-0  
Fax: +49-6251-133-1600  
**Product Information Center:  
(Technical Support)**  
Phone: +49-6251-133-1999  
Fax: +49-6251-133-1988

**Germany** – Langen  
Phone: +49-6103-709-0  
Fax: +49-6103-709-1223

**Germany** – Speyer  
Phone: +49-6232-30-0  
Fax: +49-6232-30-2243

**Germany - HTS Division** – Neunkirchen  
Phone: +49-2247-305-0  
Fax: +49-2247-305-122

**Greece** – Athens  
Phone: +30-210-9370-396/397  
Fax: +30-210-9370-655

**Hungary** – Budapest  
Phone: +36-1-289-1000  
Fax: +36-1-289-1010

**Ireland** – Dublin  
Phone: +353-1-820-3000  
Fax: +353-1-820-9790

**Israel** – Yokneam  
Phone: +972-4-959-0508  
Fax: +972-4-959-0506

**Italy** – Collegno (Torino)  
Phone: +39-011-4012-111  
Fax: +39-011-4031116

**Lithuania** – Vilnius  
Phone: +370-5-2131-402  
Fax: +370-5-2131-403

**Netherlands** – 's-Hertogenbosch  
Phone: +31-73-624-62-46  
Fax: +31-73-621-23-65  
**Product Information Center:  
(Technical Support)**  
Phone: +31-73-6246-999  
Fax: +31-73-6246-998

**Norway** – Nesbru  
Phone: +47-66-77-8886  
Fax: +47-66-77-8855

**Poland** – Warsaw  
Phone: +48-22-45-76-700  
Fax: +48-22-45-76-720

**Romania** – Bucharest  
Phone: +40-21-311-3479/3596  
Fax: +40-21-312-0574

**Russia** – Moscow  
Phone: +7-495-926-5506/07/08/09  
Fax: +7-495-926-5505

**Russia** – St. Petersburg  
Phone: +7-812-718-8192  
Fax: +7-812-718-8193

**Slovenia** – Ljubljana  
Phone: +386-1561-3270  
Fax: +386-1561-3240

**South Africa** – Port Elizabeth  
Phone: +2741-503-4500  
Fax: +2741-581-0440

**Spain** – Barcelona  
Phone: +34-93-291-0330  
Fax: +34-93-201-7879

**Product Information Center:  
(Technical Support):**  
Phone: +34-93-291-0330  
Fax: +34-93-200-3779

**Sweden** – Upplands Väsby  
Phone: +46-8-50-72-50-00  
Fax: +46-8-50-72-50-01

**Switzerland** – Steinach  
Phone: +41-71-447-0447  
Fax: +41-71-447-0444

**Turkey** – Istanbul  
Phone: +90-212-281-8181/2/3  
Fax: +90-212-281-8184

**Ukraine** – Kiev  
Phone: +380-044-206-2265  
Fax: +380-044-206-2264

**United Kingdom** – Swindon  
Phone: +44-8706-080-208  
Fax: +44-1793-572-109  
**Product Information Center:  
(Technical Support)**  
Freephone GB: 0800-267-666  
Phone: +44-208-420-8341 or 8343  
+44-208-420-8081

**United Kingdom – Raychem &  
Identification Products**  
Phone: +44-1793-528171  
Fax: +44-1793-572-516

**For Middle East/African Countries Not  
Shown**  
Phone: +33-1-3420-8866  
Fax: +33-1-3420-8300

**Tyco Electronics Corporation**  
Harrisburg, PA

tycoelectronics.com

82021-XXX-MS-FP-Rev. 6-07 OG3B

