

Table of Contents

Tyco Electronics Embraces the Most Valued Brand Names Worldwide	ii
About Raychem Wire and Cable, Harnessing and Heat-Shrinkable Products	iii
How to Use this Catalog	iv

Application Overview

Seal It	1-1
Connect It	1-2
Insulate It	1-3
Protect It	1-4
Wire It	1-5
Hold It	1-6
Join It	1-7
Beautify It	1-8
Reduce It	1-9
Repair It	1-10
Flex It	1-11
All of It	1-12
Application Guide	1-13

Electrical Interconnection System Design

Harness Design	2-2
Protection of Harness Components	2-5
HarnWare Harness Design Software	2-6
Integrated Military Harness Systems for Defense and Allied Industries	2-15

Product Sections

Heat-Shrinkable Tubing	3
Molded Parts	4
Adhesives	5
Adapters	6
Assemblies	7
Electrical Interconnect Products	8
Wire and Cable	9
Application Equipment.....	10

Supporting Information

Equivalents and Conversions	11-2, 11-3
Temperature Conversion	11-4, 11-5
Glossary	11-6 to 11-18
Part Index	11-19 to 11-21

Tyco Electronics Embraces the Most Valued Brand Names Worldwide

As a truly global player, Tyco Electronics Corporation has facilities located throughout the world serving customers in a wide range of applications.

Tyco Electronics Corporation – the largest unit of Tyco International Ltd. – was established in September 1999 when Tyco acquired Elcon Products and Raychem Corporation, and integrated them with AMP, acquired earlier the same year. Since then, the company has rapidly grown and strengthened its competencies as an electrical and electronic component supplier, with product offerings in 25 passive and active product segments. In the passives field, Tyco Electronics is now the world's largest supplier.

The company has facilities located around the globe serving customers in the aerospace, automotive, commercial electronics/communications, industrial/energy, marine, medical,

military, and rail industries. Tyco Electronics' product portfolio continues to grow, encompassing connector systems and application tooling, active and passive fiber optic devices, complete power systems, wireless components (including ICs, radar sensors, and complete communications systems), GPS and integrated antenna systems, heat-shrink products, circuit protection devices, magnetic components, wire and cable systems, touchscreens, PC boards and backplanes, smart cards, relays, sensors, electronic modules, wire harnessing and labeling products, battery packs, terminal blocks and switches.

A significant result of this continued growth, and a

real benefit to customers, is that Tyco Electronics' technology leadership becomes even stronger. The synergies of expertise in materials science, product design, and process engineering, coupled with knowledgeable application engineers, sales representatives, and customer service personnel enables you to make your next generation of products successful.

About Raychem Wire and Cable, Harnessing, and Heat-Shrinkable Products

Tyco Electronics, for its Raychem products, pioneered the application of radiation crosslinking and the development of heat-shrinkable polymer tubing.

The Tyco Electronics Raychem brand of heat-shrinkable polymer products is recognized worldwide. It is backed by a history of proven performance, reliability, innovation and superior quality. Tyco Electronics manufactures the world's largest range of heat-shrinkable tubing – tubing that provides cable protection offering exceptional insulation, mechanical protection, and strain relief. We are the recognized world leader in heat-shrinkable polymer technology.

A broad-based product line of Raychem wire and cable is engineered to meet or exceed the most rigorous technical specifications. Performing from -100°C to $+260^{\circ}\text{C}$ [-148°F to 500°F], the product line encompasses fire-resistant cable, small-size controlled electrical cables, multi-conductor cable, high-performance radiation crosslinked ETFE

airframe wire, low fire hazard wire, high-performance automotive and commercial wire, and NASA-spec and other space-application types. Additionally, a variety of low-cost, easy-to-install components for wire harnesses and cable assemblies are available including splices, adapters, low-profile rectangular connectors, and contacts. These components are approved to widely recognized standards and specifications that include UL, SAE, MIL, Defense, DNV, Lloyds, and ABS.

Tyco Electronics also provides customized harnessing design supported by a pioneering software package, *HarnWare*, which enables fast, optimum system design with materials and assembly labor estimates.

For over forty-five years customers have recognized

the global capabilities of Raychem products. Combining these advanced products with superior technical support and a global sales/service organization, customers with worldwide operations count on Tyco Electronics to supply the knowledge and products they need to solve specific problems and help them take advantage of opportunity, anywhere it arises. This philosophy has earned Tyco Electronics a reputation for leadership in materials science technologies. Developed from these technologies, Raychem products are sold into many industries including aerospace, automotive, electronics, construction, electrical power, utilities, manufacturing, pipeline, process, rail and mass transit, and telecommunications.

This catalog has four main sections:

- Application Overview
- Electrical Interconnection System Design
- Products
- Supporting Information

How To Use This Catalog

Application Overview

(Section 1) presents general design ideas based on typical uses for Raychem-brand wire and cable, heat-shrinkable tubing and protection products.

Application photos depict examples of how customers use our products to enhance the performance and improve the reliability of their specific products in one or more of these generic applications; Seal It, Connect It, Wire It, Insulate It, Protect It, Hold It, Join It, Beautify It, Reduce It, Repair It, Flex It, All of It.

Electrical Identification System Design (Section 2) describes wire harness components and harness protection issues and provides a step-by-step guide to selecting the right Raychem components for a particular wire harnessing system.

Products (Sections 3-10) showcases our product groups. Each section provides:

- An **overview** of the product group.
- A **table of contents** that lets you see at a glance the product families in that product group.
- A **selection guide** to help you determine which product family will satisfy the requirements of your application.
- An explanation of the **part numbering system** for that product group.
- **Information pages** on each product family.

The product information pages provide some or all of the following information (depending on the product family):

- Typical applications for the product family.

- Product features/benefits.
- Abbreviated installation guidelines.
- Specifications and agency approvals.
- Part number selection information
- Product data (dimensions, properties, and materials).
- Ordering information.
- Location availability.

Supporting Information (Section 11) provides:

- Equivalents and conversion tables.
- Temperature conversion table.
- Glossary.

Use these icons to quickly identify market opportunities at-a-glance. They appear on the product information pages. The icons on each page represent, but are not limited to, the markets that currently exist for that particular product.

Market Icons



Medical



Automotive



Commercial Electronics/Communications



Industrial



Aerospace



Marine



Military



Rail Industries



Space



Advanced materials and product design have resulted in a complete line of products offering the most effective sealing available today: adhesive-lined tubing, molded parts, and a variety of solder and crimp connection devices. These easy-to-use products provide superior waterproofing, resistance to hydrocarbons and other chemicals, protection against corrosion and oxidation, and a barrier against dust and dirt.

- Heat-shrinkable, adhesive-lined products—tubings with high shrink ratios, and molded parts—environmentally protect connector-to-cable transitions.
- Waterblocked and anticapillary wire prevent water and most fluids from wicking between the conductor strands. Bundle sealing products block multiconductor cables.
- Adhesive-lined, heat-shrinkable tubing and caps seal and protect electronic components and in-line wire splices from fluids, moisture, and corrosion while also providing strain relief.
- Heat-shrinkable caps lined with an adhesive or encapsulant form a moisture-resistance barrier around stub splices and wire ends.
- Heat-shrinkable, moisture blocking systems are designed to provide reliable sealing of wire bundles preventing fluid ingress.



Raychem electrical interconnect products offer reliable, more cost-effective alternatives to traditional connection methods—such as hand soldering, or crimping and then insulating by taping or overmolding.

With our electrical interconnect products, you start with a precisely engineered, fluxed solder preform inside a transparent, heat-shrinkable sleeve. When the product is heated, the solder preform melts, and the sleeve shrinks to create a connection that is fully insulated and strain-relieved.

This ease of use expands your options even as it enhances the quality of your end product, as in these applications:

- Easy and reliable termination of EMI shields to ground, ensuring effective EMI attenuation. Shield termination products are available for computer, data, and instrumentation cable, communications and video cable, and heavy industrial cable.
- Splicing of one component to another, such as a diode connected to one end of an LED.
- Coaxial terminations to PCBs and terminals.

Insulate It



Solving an insulation problem can be easier than you think, especially when you consider the family of Raychem products from Tyco Electronics that can provide superior alternatives to standard methods of insulation such as hand-taping or molding-in-place.

- When heated during installation, our radiation-crosslinked tubings shrink to conform to a variety of shapes, providing dependable insulation.
- Heat-shrinkable end caps insulate wire or cable terminations, providing protection from dust and dirt. End caps with adhesive or encapsulant lining also provide protection from moisture because the lining, when heated, melts and flows to fill surface irregularities of the substrate.
- General-purpose polyolefin tubing is widely used to insulate and strain-relieve wire terminations and connections.
- Delicate electrosurgical instruments can be insulated and protected from abrasion by using one of Raychem's medical-grade, heat-shrinkable tubings specially formulated to meet the requirements of USP Class VI for medical use.
- Components on a PCB, such as capacitors and fuses, can be insulated with a UL VW-1-approved heat-shrinkable tubing to achieve a specific product rating.



Designing a brilliant solution is good. Protecting a brilliantly designed solution is even better. A whole family of protection products, made from a wide variety of materials, can provide comprehensive protection: mechanical protection, strain relief, resistance to abrasion and crushing, EMI and noise reduction, fluid resistance, and thermal insulation.

- Tinel-Lock ring braid terminations can be used for applications where shielding is critical. These shape-memory-metal products attach metal braid shields to backshells and provide 360° protection against EMI and EMP.
- Heat-shrinkable tubings provide mechanical protection for hoses and pipes, and also reduce problems caused by wire chafing or cable abrasion.
- Easy-to-install heat-shrinkable tubing and molded parts provide excellent strain relief and electrical insulation for connector-to-cable transitions.
- A heat-shrinkable molded part can relieve the strain on a multiconductor cable to a D-subminiature connector.
- Heat-shrinkable feedthroughs relieve the strain on cables entering junction boxes.
- Highly-flexible, heat-shrinkable fabric tubing provides outstanding abrasion protection for components such as rubber hoses, plastic pipes, and harness wiring bundles, recovering easily even over awkward substrates such as bent hoses.
- Heat-shrinkable MicroFit tubing is used to provide insulation and strain relief for fine-gauge wire (24 to 42 AWG) and fiber optic cables in such end products as medical devices, computers, communications equipment, and commercial electronic products.



Tyco Electronics is a leader in the development of high-performance wire and cable products for demanding applications, including aerospace, industrial equipment, instrumentation, marine, and automotive applications. Precision extrusion capability, materials expertise, and design knowledge provide wire products that are lightweight; smaller than comparable-performance constructions; highly flexible, yet mechanically tough; flame-retardant and resistant to a variety of industrial fluids.

All Raychem products offer outstanding shop-handling characteristics for efficient stripping, wire termination, and bundling. Cable design software is available to create custom multicore cables with unique components, tough but lightweight jacket materials, and optimized shielding. Tyco Electronics can also design complete wiring harnesses for industrial or military applications.

- The FlexLite family of hookup wire provides economical alternatives to fluoropolymers, silicones, and crosslinked polyethylene insulations for applications such as motors, appliances, and lighting, and for applications where thinner walls are needed because of space constraints.
- Raychem high-temperature, dual-wall or single-wall aerospace wire saves space and weight on both military and commercial aircraft and space vehicles.
- Low-fire-hazard primary wires and cable are made from halogen-free, low-smoke materials with a low toxicity index. They offer increased safety, with reduced size and weight, over traditional materials in mass transit and similar applications.



To help you arrive at the best way to securely hold and position a component, take a look at the Raychem family of products and consider the many ways that you can use them: to keep components in place, bundle and route wires, create a formed shape for potting, or package components securely before final assembly.

- Thin-wall tubings allow bundling of wires to create very flexible, light-weight harnesses that can withstand harsh environments.
- Fiber and/or copper components can be bundled for a custom multicore cable.
- Cable legs can be held together with a Y-transition molded part.
- Multicore and film-bonded cables hold wires together and also provide EMI protection.
- Tubing can hold a covering (braid or Convolex tubing) onto a substrate.
- Two components (such as a resistor and fuse) can be held together as a package by enclosing them with heat-shrinkable tubing.
- Heat-shrinkable fabric tubing will grip substrates, such as harnesses, tightly to provide secure wire bundles without additional fixing.



When you have a mechanical connection to make, consider the uniform circumferential recovery force of heat-shrinkable tubing and metals in your designs.

- Join two dissimilar materials, such as a rubber flap-per to the end of a nylon tube, or the handle of a medical instrument to the instrument's moving parts.
- Assemble a bellows by covering a spring with heat-shrinkable tubing.
- Use Tinel ring adapters to provide the even circumferential force necessary to attach a metal braid shield to a backshell.
- Clear, adhesive-lined tubing connects water tubes in appliances to provide a rugged and aesthetically appealing joint which is also inspectable.
- Heat-shrinkable tubing is used to join polyester cords to heddles in Jacquard weaving loom harnesses.

Beautify It



Enhancing the appearance of your brilliantly designed solutions couldn't be easier, when you use Raychem products.

- Heat-shrinkable tubing—instead of tape—can create a smooth covering with no loose ends.
- Hot-stamp foils (gold or silver) can attractively showcase a company logo.
- Heat-shrinkable tubing can cover the mechanical attachment of one part to another.
- Tubing can attractively cover a metal railing, such as the type used for crowd control.
- Tubing or molded parts can be color-matched to the original color of fiber, wire insulation, or other components to enhance the appearance of the final product.
- Handles of a variety of tools can be covered with colorful, heat-shrinkable tubing to enhance the appearance of the final product.

Reduce It

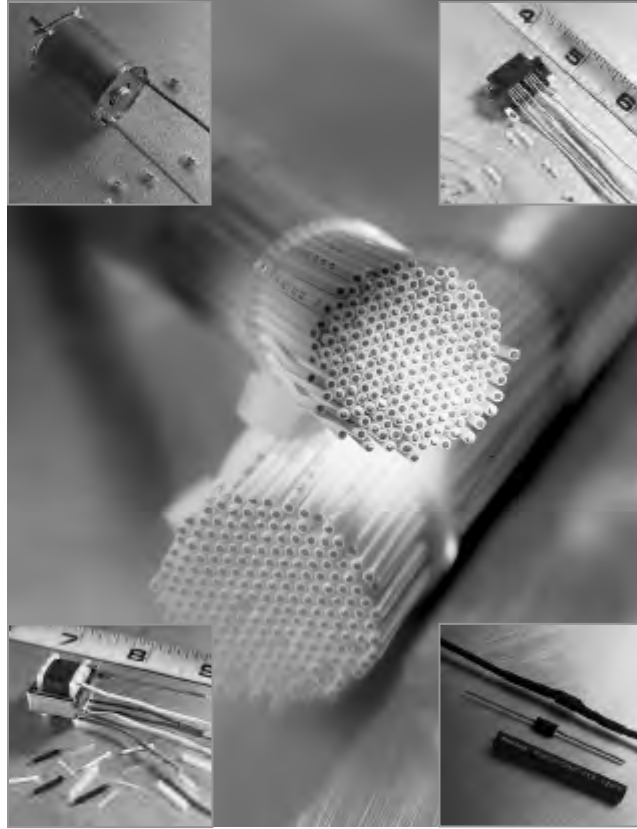

With the trend toward miniaturization and higher-density interconnections, products developed for commercial electronics applications must downsize as well.

- Versafit V4 tubing—33 percent lighter and smaller than competitive products—is the perfect choice when you need a very-low-profile, thin-wall tubing that installs quickly. In addition to space savings, V4 tubing offers excellent mechanical protection and strain relief for sensitive components.
- The MicroFit family of products can be used to connect and insulate fine-gauge wire (26 to 42 AWG) in such end products as medical devices, computers, and stereo systems. They are easily and quickly installed, thus reducing craft-sensitive labor. MicroFit tubing has a high shrink ratio, up to 3:1, allowing easy installation onto the wire or substrate.
SolderSleeve MicroFit devices feature a one-step controlled solder process for splicing and terminating wires up to 36 AWG—a method that is more reliable and less craft-sensitive than hand-soldering.
- Tyco Electronics can reliably produce primary Raychem wire insulations as thin as 4 mils. Our design software optimizes component placement and shielding to produce small, lightweight custom multicore cables. These cables can offer size and weight reductions that can range from 10 to 40 percent versus comparable-performance constructions of primary wire or cable.



Whether for repair or retrofitting, Tyco Electronics offers a whole family of Raychem products that can provide flexible, cost-effective solutions. For example, most failures in electrical wiring harnesses occur within the first six inches of the connector. Raychem products make repairs in this area more reliable, long-lived, and cost-effective.

- High-shrink-ratio tubing can be slipped over the connector without depinning to reinsulate or strain relieve the connector-to-cable transition.
- SolderShield repair splice kits provide the components necessary to splice shielded single-wire or multicore cables.
- Adapters and Uniboot molded parts can be combined to allow reentry to the back of the connector area for pin repair.
- Splash-resistant SCL semirigid heat-shrinkable tubing, with its meltable inner wall, can be stripped off the substrate without leaving a sticky residue, thus providing access to connections requiring reentry.
- Flexible, adhesive-lined tubing can be used to repair damaged wire insulation, providing a moisture seal that is resistant to bending of the wire substrate.



In applications where flexibility or flex life are important, Raychem products meet the need—many performing even at low temperatures.

- NT tubing, which is widely used for insulation, strain relief, and abrasion protection on cable harnesses and wire bundles, remains flexible at low temperatures (as low as -70°C [-94°]) without cracking.
- Hi-Flex heat-shrinkable tubing was developed specifically for sealed cable-jacketing applications where cable flexibility is an important concern. It is also ideal for situations where the cable is subject to motion, such as in industrial machinery, transportation equipment, robotics, and welding.
- For applications where a flexible 90° bend right after the connector is desired, Uniboot molded parts can provide the perfect fit.
- DynaLink wire and cable is designed specifically for applications where flex life is critical: in the robotics industry; in lifts, typing machines, and sewer inspection equipment; and on ships where wire must be capable of unwinding from a large cable reel and then retracting smoothly without strain.



At Tyco Electronics Corporation, we like the word "multitasking." So it should come as no surprise that Raychem products are designed to help you integrate several tasks—seal, connect, insulate, protect, wire, hold, join, beautify, reduce, repair, and flex.

In the pages of this catalog, you will find literally hundreds of products designed to provide thousands of solutions—across a wide variety of industries.

Although you will find the catalog features an extensive array of products, keep in mind that, at Tyco Electronics Corporation, we're always coming up

with new ideas and new products—so that we can help you put together the precise solution you need. Also, when you choose any Raychem product, you're automatically backed by a nationwide network of sales engineers who can provide application and engineering assistance as well as on-site training.

Tyco Electronics manufactures an extensive selection of Raychem quality products that hold, seal, protect, connect, and insulate. Whatever your design challenge, take advantage of the Tyco Electronics experience to help you find the right solution.

Tyco Electronics has led the way in creating and supplying high quality, technologically advanced products for use in a broad range of industrial and commercial applications. When you choose any Raychem product, you're backed by a worldwide network of sales engineers who provide application and engineering assistance as well as on-site training.

The products shown in Application Guide #1654725 (07-03) are just a sampling of the many Raychem products Tyco Electronics offers. Order your copy today!

Give us a call or visit us at www.tycoelectronics.com/Raychem so we can help you put together the precise solution you need.

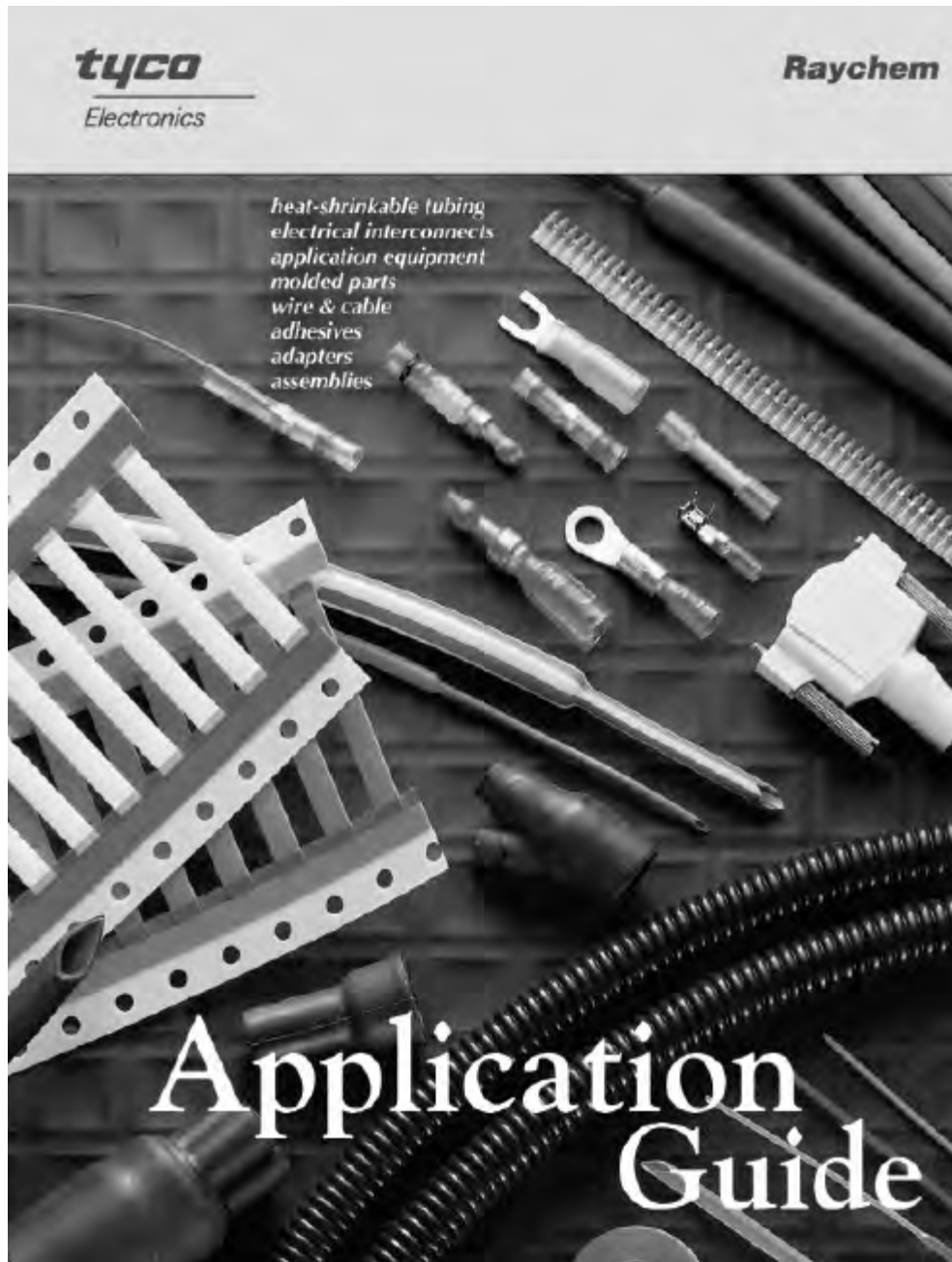



This section attempts to provide assistance with most of the considerations applicable to the design of cable and harness assemblies. Caution must be used to ensure that the design is appropriate for a particular application.

Tyco Electronics provides this information as a design aid and assumes no responsibility for and makes no representation regarding the suitability of a design for a specific application.

Table of Contents

Harness Design2-2 to 2-4
Protection of Harness Components2-5
HarnWare Harness Design Software2-6 to 2-14
Integrated Military Harness Systems for Defense and Allied Industries2-15 to 2-25

Note: Users should independently evaluate the suitability of the product for their application. Before ordering, check with Tyco Electronics for most current data.



Harness Design



A Raychem molded part provides strain relief on the back end of a connector.

Tyco Electronics offers a range of Raychem components for wiring harnesses and cable assemblies in commercial, industrial, automotive, and defense and allied industries. Our components are approved to widely recognized standards (UL, CSA, CE, SAE) and to the military specifications of various governments.

A variety of component material systems can be used to design a rugged, reliable, repairable, shielded, and environmentally sealed harness. We also offer individual components that can be used independently to meet a specific sealing, insulation, strain relief, protection, identification, or electrical interconnection need.

Harnessing system components include:

- Heat-shrinkable tubing
- Heat-shrinkable molded shapes
- Adhesives
- Adapters
- Assemblies
- Electrical interconnect components
- Wire and cable
- Solder termination devices
- Application equipment

In many cases, properly selected components can raise the performance of a harness to acceptable levels compatible with even very demanding environments where cables are exposed to water, temperature extremes, EMI-radiated fields, or fluids.

Tyco Electronics is the established leader in automotive, aerospace, marine, mass transit, industrial, and military harnessing. Call us for ideas on protecting your harness—whether it's a typical UL wiring system or a harness assembly for demanding environments.

Harness Design

Designing wiring harnesses for demanding applications such as defense and aerospace is a complex business:

- Many different parts need to be selected while taking account of various environmental factors and mating part conditions. There can be a large number of alternative design solutions to analyze and the constraints imposed upon harness design are becoming more demanding.
- Weight and space are especially important in missile and aerospace applications. With the additional electrical equipment now in products such as cars, these factors are becoming a bigger issue in these industries.
- Electromagnetic interference (EMI). Harnesses can either radiate interference to, or pick up interference from, nearby equipment. With the increasing use of sensitive electronics in cars, aircraft and military equipment this is a major problem.
- Resistance to environmental hazards including corrosion, high temperature or fire, chemical and nuclear agents. The additional costs of totally sealed wiring harness systems are becoming easier to justify as products and the lives of those who use them, become more dependent upon the fault free operation of electrical systems.
- Repair and maintainability. Electrical and electronic systems in military vehicles and naval vessels now need to be upgraded or modified several times during the life of the main mechanical platform. There are now parts and harness design techniques that make this work easier to accomplish.

Harness Design (Continued)

This section provides information about the basic components in a harness design, the factors to consider in designing a harness, and the Tyco Electronics HarnWare Harness Design CAD software. With this information and the selection tables that follow, you will be able to choose from this catalog the right components for an integrated military or high-performance industrial harnessing system.

The checklist on page 2-4 covers some of the factors to consider in the design of a harness.

Harness Components

Connectors and wires are the two basic components of a harness that need to be specified. Once they have been chosen, compatible protection, shielding and identification follow.

Connectors

Connectors come in two opposite types: plugs and receptacles. Both contain contacts, usually made of plated copper. The contacts, called pins or sockets, are joined to the conductors and are designed to mate or join with contacts of the opposite type.

The front or joining end of the connector is designed to mate only with a connector having the right configuration. The back end of the connector is where the wires are terminated to the metal contacts.

Connectors for indoor or internal use are generally not designed to resist moisture. Connectors that will be exposed to moisture are generally sealed to meet a specific requirement.

Wires

In this discussion, a wire is defined as an insulated conductor and a cable is defined as two or more wires with or without a common jacket or shield. Conductors are usually made from copper.

A copper conductor can be solid or, when flexibility is important, can consist of smaller strands of copper wire twisted together. The strands can be coated with tin, nickel, or silver to make them easier to terminate or more resistant to corrosion.

Conductors are sized in metric units (mm²) or by AWG (American Wire Gauge), a holdover from the days when wire was made of steel in steel mills. The AWG refers to the

number of passes it takes to draw the wire down to the required size - the larger the AWG, the smaller the wire. Making a 26 AWG wire, for example, requires more passes through reduction dies than are required for a 4 AWG wire.

A 26 AWG stranded wire, however, is made of many smaller wires, such as seven strands of 32 AWG wire (sometimes shown as 7/32 or 7x32).

The choice of insulation for a conductor depends on a number of factors:

- Operating, design, and excursion temperatures of the system
- Size and weight limitations
- Mechanical performance desired
- Flexibility requirements
- Resistance to various fluids
- Specialized requirements, such as:
 - low fire hazard or low halogen
 - low outgassing



Harness Design Checklist

Harness Design (Continued)

Connectors

- Sealed or unsealed?
- Made of plastic or metal?
- Crimp or solder contacts?
- Pins or sockets?
- Mating frequency?
- Keyway angle?
- Exposed to electrical noise (EMI)?

Geometry

- Dimensions?
- Point to point or branched?
- Configuration of ends - straight, 90°, 45°?

Environment

- Exposed to sunlight?
- Exposed to moisture?
- Immersed?
- Temperature extremes?
- Temperature cycling?
- Normal operating temperature?
- Exposed to abrasion?
- Exposed to mechanical abuse?
- Exposed to dust?
- Exposed to corrosive fluids?
- Exposed to flexing?
- Repairable?
- Circuit identification?
- Cable identification?*
- Shielding effectiveness?
- Magnetic-field-induced signals?

Circuit

- Voltage?
- Current?
- Signal transmission (impedance, velocity, frequency, etc.)?
- Circuit layout?
- Is circuit integrity critical? What if the circuit fails?

*Tyco Electronics Identification products information available at www.tycoelectronics.com

Protection

Once the connectors and wires have been specified, the method of protection must be considered. Various jacket materials are available to protect the wires and these can be extruded or heat-shrink. Jacket material formulations are compounded to meet a wide range of environmental demands.

Similarly, protection for the wire termination must be considered. In general, the wires will be terminated to connector contacts. Protection products must protect the joints from damage caused by mechanical stress such as flex, torque and tensile load, and corrosion or electrical breakdown from fluid ingress, while retaining the ability to be repaired. All these influ-

ences and more must be considered when choosing the termination protection method.

Shielding and Shield Termination

Step 3 of the component selection process discussed later in this section gives advice on choosing the appropriate shielding products for the gross shield. Consideration must also be given to the individual cable shield terminations. Can they be pigtailed together with a common termination to a contact or to earth, or should they have individual terminations? If using a solder device, the correct choice is based, not only on size, but also temperature rating or compatibility with the cable braid.

Identification

Circuit identification is important, both in manufacture, where an assembly operator must ensure correct wire to contact termination, and in repair, where a damaged connector may need replacing in difficult circumstances and contact positions have to be easily identified. Individual wire markers help with these two circumstances. Where a cable is severed and access to the ends is prevented, unique identification on the wires, or wire color coding aids repair.

Consideration given to the identification of harness legs is also important. Connectors will normally be chosen with unique keying to prevent incorrect mating but end identification will

speed up plugging, particularly for multi-connector harnesses.

It is also good practice to label the harness with its part numbers and other relevant information for traceability purposes.

The Tyco Electronics Identification Products Group offers a variety of products that are compatible to the HarnWare software design process.

For complete information regarding these products visit our website at www.tycoelectronics.com.

Protection of Harness Components



A salt deposit can be seen beneath the end of this 18-AWG, 19-strand wire. The other end of the wire has been immersed in salt water for 24 hours.

Harness components are vulnerable to corrosion, stress, strain, and electromagnetic interference (EMI).

Corrosion

Humidity, moisture, salt, and corrosive fluids can corrode conductors and contacts. What is worse, the corrosion can take place well beyond the point of penetration because of the small tube-like voids—capillaries—between the individual strands of copper that make up the conductor. Called “capillary action,” the penetration of a fluid can “wick” many feet in a relatively short time (see photo above), depending on the specific characteristics of the affected wire. As the copper in the conductor is depleted by corrosion, the conductor can no longer sustain mechanical or electrical loads and the metal will fail. Mechanical failure can thus occur anywhere in the wiring system.

Even before mechanical failure occurs, electrical

performance can be adversely affected by the presence of nonconductive by-products from galvanic or aqueous corrosion. Moisture within a connector body may cause an impedance mismatch, increase noise in a signal circuit, or modify the waveform. Even small amounts of corrosion or other contaminants can have a significant impact on contact surfaces and the efficiency with which signals flow through them.

If a chemical solution contacting the electrical connection is itself conductive it can cause a short circuit between conductors. Pure water, not itself a conductor, can also facilitate a short circuit by providing a medium into which conductive salts can dissolve. These salts may be the by-products of corrosion or the result of earlier contamination.

High humidity and temperature cycling in some situations cause condensation, the accumulation of which can also result in a short circuit. Depending on circumstances, the resulting short circuit may be intermittent, significantly complicating the process of identifying the underlying cause.

To prevent corrosion, sealing may have to meet the performance requirements of applicable military specifications or the International Protection (IP) Code.

Stress and Strain

Wires that are attached to the connector pins need help to withstand stresses and strain from the cable, which could break the wires from the pins. It is almost always necessary to prevent strain from occurring in

a weak spot, such as where the wire is attached to the contact. This is called strain relief and can be provided in a variety of ways, from mechanical devices, such as adapters, to molded boots and heat-shrinkable tubings.

EMI (Electromagnetic Interference)

EMI is similar to the noise heard on an AM radio when the radio is close to high-voltage lines. EMI causes the wire or cable to act like an antenna and pick up electrical signals, which interfere with the signals on the wire and can cause malfunctions in sensitive electronic circuits.

Wiring systems are susceptible to two types of EMI:

- **Radiated emissions** (the electromagnetic energy a wiring system radiates to its surrounding environment), such as the EMI a high-voltage line radiates to its surroundings. (There are regulations on the amount of radiated energy a circuit is allowed to produce.)
- **External radiated emissions** (the electromagnetic energy in the environment), such as the EMI an AM radio picks up from a high-voltage line, causing distortions in the conducted signal. Conducted EMI is noise carried by the cable into the receiving circuit and needs to be filtered.

To reduce susceptibility to radiated emissions from the cable or from external sources, the harness must be grounded, shielded, and/or filtered, depending on the sensitivity of the equipment and the strength and frequency of the EMI.

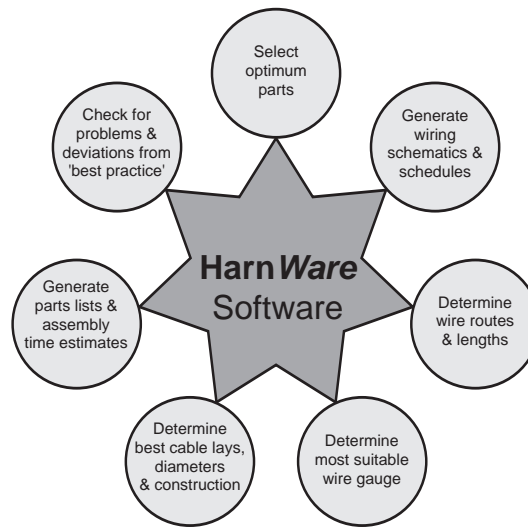

HarnWare Design Software is Tyco Electronics' harness design CAD software. Originally developed for use by our own harness designers it is now offered to our customers so they can benefit from this powerful tool.

From a simple input of geometry, dimensions, connector and wiring details, HarnWare software can suggest a design sequence and help with many aspects of wiring harness design (see diagram).

HarnWare software is used interactively by harness design engineers. The choices and calculations made by the system can always be modified to suit specific requirements. Design data is saved with each shape in the harness drawing. This data can be reviewed simply by moving the mouse over the parts listed in the Design Wizard. It is, therefore, very easy to incorporate design changes, modify design constraints or analyze alternative design solutions. Moreover a design checker can be used to search for deviations from 'best practice'.

Some HarnWare Software Outputs

The following are some examples of the outputs that HarnWare software can generate:

- High quality engineering drawings. Clear and reliable drawings play a crucial role in the success of any design project.
- Point-to-point wiring lists, including calculated wire lengths.
- Fully detailed parts lists. HarnWare software automatically generates the parts list table and adds item number balloons into the drawing. Parts lists can also be exported to a spread sheet, database or word processor.
- Assembly time estimates. HarnWare software automatically adds the design details into a 'spread sheet' containing standard assembly time synthetics.

- Wiring schematics and schedules are quickly produced using connector plan form data and wiring details from the wire list.
- Lists of codes of practice describing harness assembly techniques and other issues that are relevant to the parts included in the design.
- Files containing cable marker details can be exported ready for use in marker printing systems such as the Tyco Electronics WinTotal* system. A drawing page showing these cable marker details can also be generated.

A sample set of documents produced by HarnWare software is shown at the end of this section.

*Tyco Electronics Identification product information available at www.tycoelectronics.com

HarnWare Harness Design Software (Continued)

System Building Blocks

Some key features of HarnWare software are:

- Runs under Microsoft Windows on affordable PC's.
- The user interface is similar to that of commonly used software such as Microsoft Word and Excel.
- Uses the Visio drag and drop drawing system for creating harness drawings more quickly and more easily than with other computer aided design (CAD) systems.

- Software to help identify the parts most suitable for use within the given design constraints and to fit the mating parts, cables, etc.
- On-line help systems for guidance on using the system and on Raychem wiring harness products.

Designing a Harness With HarnWare Software

Shapes, representing Raychem harnessing products, are dragged and dropped into the harness assembly drawing. The shapes automatically snap and glue together and it takes very little time to produce a high quality drawing. Pages from a sample HarnWare software document set can be seen on page 2-14. Dimensions and connector references are entered by clicking a shape and typing in the numbers and references.

The HarnWare Software Design Wizard analyzes the drawing and lists the parts and operations in the suggested design sequence. The wizard also provides quick access to details on each part in the harness and the connections between parts. When the mouse is moved over the parts listed by the wizard, HarnWare software outputs such details as part dimensions, materials, finishes, etc.

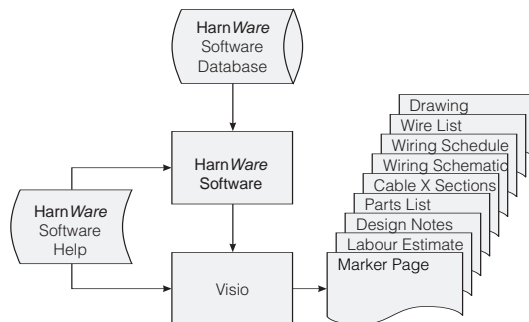

- A growing library of 400 intelligent drawing shapes and a 110,000 record design database which can generate 100,000s of part descriptions for Raychem wiring harness products in their various material and finish permutations.
- Software that traces wire routes through harnesses and automatically creates wiring schematics and calculates wire lengths.
- Analysis options to determine the optimum lay of cables containing mixed diameter wires and to suggest the most appropriate wire gauge for specified current and temperature rise limits.



HarnWare software indicates the Raychem harness material system that is most suited to the given application, operating temperature range and required defense specifications.



HarnWare Harness Design Software (Continued)

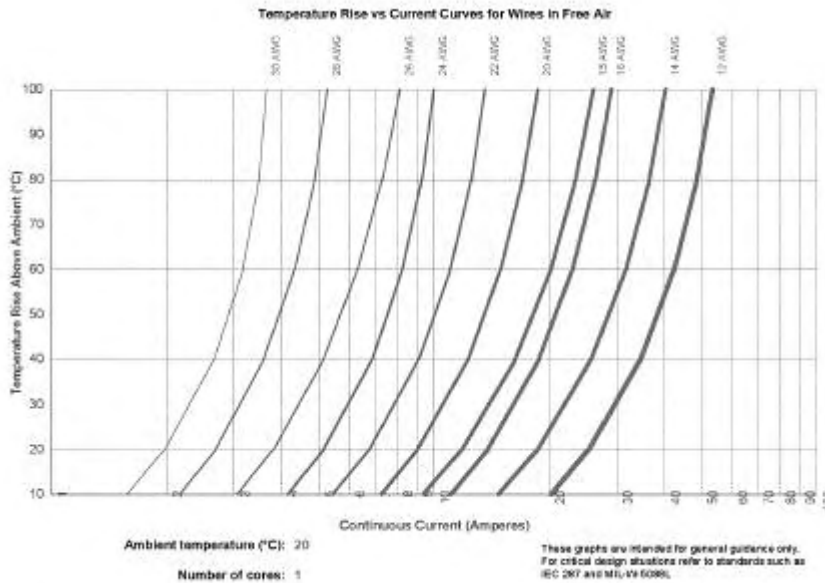
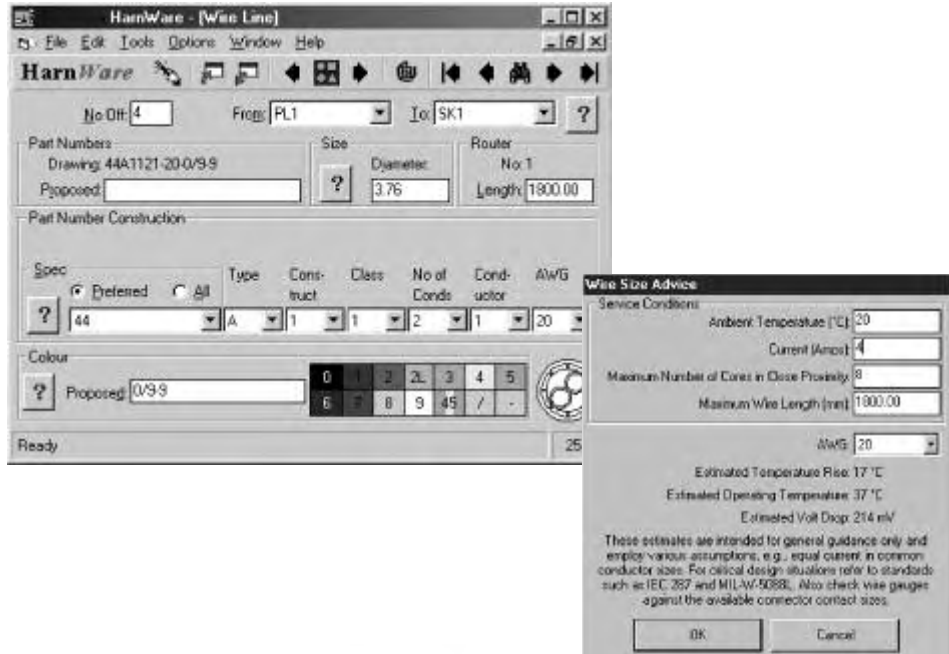

Wire Selection

The wire most suited to the particular environment and service conditions is selected using design rules encoded in the HarnWare software and database. If the wire selected is a non-preferred option, alternative types and colors can be identified which may also suit the design requirements and be available on shorter delivery times.

Guidance is also available for choosing the wire gauge most suited to given current loading, ambient temperature, length, number of conductors, etc. For each available wire size HarnWare software estimates temperature rises, operating temperatures and voltage drops.

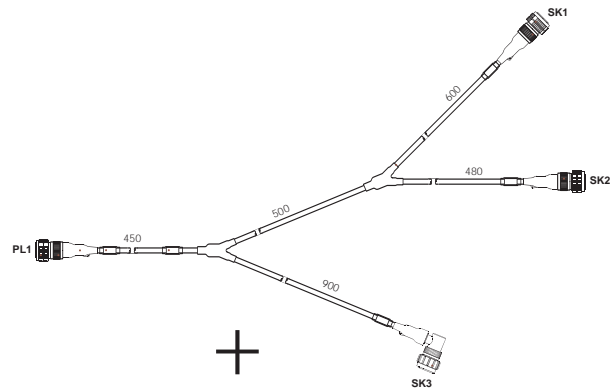

WIRE LIST						
WIRE NO	ITEM NO	QTY	FROM	TO	PART NO	LENGTH
1	2	4	PL1	SK1	44A1121-20-D9-9	1800.00
2	2	5	PL1	SK2	44A1121-20-D9-9	1668.00
3	1	19	PL1	SK3	44A0111-20-9	1590.00

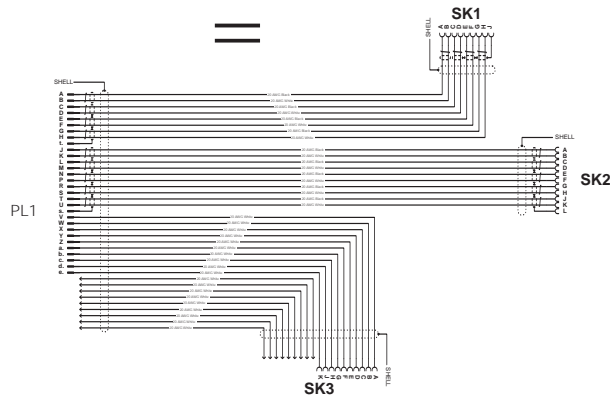

Wire Selection (Continued)

From-To connector references are specified to form a point-to-point wiring list. Wiring schematics can be generated automatically from the information included in the wire list. These schematic diagrams show the pin to pin wiring for all the connectors and wires in a harness design.

HarnWare software automatically:

- Traces the route of each wire in the point-to-point wire list through the harness geometry contained in the drawing.

- Calculates wire lengths by summing the lengths of the harness legs through which each wire is routed. Adjustments are applied based on a variety of design rules relating to the parts through which wires pass.
- Determines the cable sub-assembly structure that would save the maximum amount of labor in assembling the harness.
- Determines the optimum lay of wires in each harness leg and produces a cable cross-section drawing. Alternative lays of cables containing mixed diameter wires are automatically analyzed to identify the smallest

diameter and most even construction. In the example below, the listbox contains the quantity of each wire diameter for which HarnWare software has automatically developed 29 alternative design solutions. The minimum diameter alternative is shown which is 17.72 [.698] diameter and uses 2 fillers to achieve a sufficiently round lay.

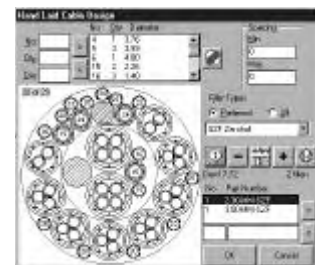

HarnWare Harness Design Software (Continued)

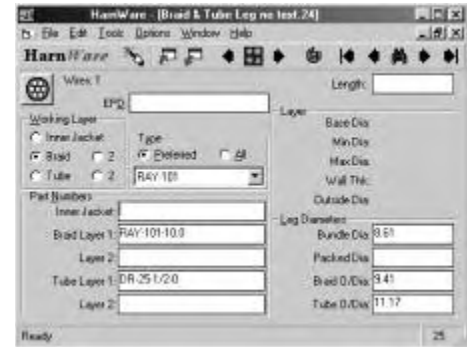
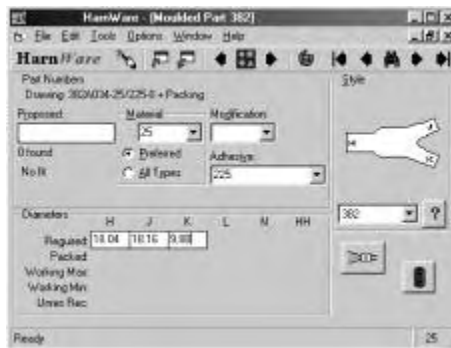

Part Selection

All the parts in a harness can be specified. The key steps in selecting parts include:

- Clicking a shape in the harness drawing or the design wizard.
- HarnWare software automatically obtains design data and dimensions from the shape and from mating parts in the harness assembly drawing. In the case of a Raychem boot, for example, HarnWare software extracts the required style of boot from the shape and the diameters from the mating harness leg and adapter.

- The database is searched for parts suited to the dimensional constraints. The choice is further refined by the service conditions which determine the best materials, finishes and adhesives. When alternative parts are found in the database, HarnWare software offers the best option first, which the designer can compare with the other alternatives. The on-line help systems contain details and advice on the various types of parts, materials and finishes and their suitability to different service conditions.

Among the parts that HarnWare software helps to select are:

- Adapters
- Braid
- Connectors
- Databus couplers, etc.
- Feedthroughs
- Heat-shrinkable tubing
- Marker sleeves*
- Molded parts
- Adhesives
- Solder sleeves
- Wire

*Tyco Electronics Identification product information available at www.tycoelectronics.com

HarnWare Harness Design Software (Continued)

PARTS LIST					
ITEM	DESCRIPTION	PART NUMBER	SPEC/REMARKS	QTY	UNIT
1	Wire	44A1121-25-0/9	Raychem	30.2	M
2	Wire	44A1121-25-0/9	Raychem	15.6	M
3	Filter	2.75MM SZP	Raychem	0.5	M
4	Filter	3.50MM SZP	Raychem	0.5	M
5	Braid	BAV101-10.0	Raychem	1.2	M
6	Braid	BAV101-12.5	Raychem	1.2	M
7	Braid	BAV101-7.5	Raychem	1	M
8	Tubing	AS099-43	Raychem	2	PC
9	Tubing	DR-25-1/2-0	Raychem	1.6	M
10	Tubing	DR-25-1/2-0.50MM	Raychem	1	PC
11	Tubing	DR-25-1/2	Raychem	1	M
12	Tubing	DR-25-3/4-0	Raychem	0.6	M
13	Tubing	BNF-100-3/16-0.1MM	Raychem	4	PC
14	Tubing	BNF-100-1/2-0.20MM	Raychem	3	PC
15	Tubing	BNF-100-1-0.20MM	Raychem	1	PC
16	Tubing	BT-375-1/2-4-46MM	Raychem	1	PC
17	Tubing	BT-375-1-4-60MM	Raychem	1	PC
18	Tubing	BT-375-3/4-4-65MM	Raychem	1	PC
19	Insulation Cap	TC4001-9			
20	Adapter	TYR40AB03-1208AA			
21	Adapter	TYR40AB03-1410AA			
22	Adapter	TYR40AB03-2014AA			
23	Adapter	TYR40AB03-1208AA			
24	Moulded Part	20K142-25225-0			
25	Moulded Part	20K153-25225-0			
26	Moulded Part	20K163-25225-0			
27	Moulded Part	20K242-25225-0			
28	Solder Device	B-051-01-01			
29	Solder Device	B-051-02-02			
30	Solder Device	ST3-3-18-20-90			
31	Marker Sleeve	TMS-NR501-NR19-4-45-60			
32	Marker Sleeve	TMS-NR501-NR19-4-45-60			
33	Marker Sleeve	TMS-SCE-1-2-0-4			
34	Marker Sleeve	TMS-SCE-3/4-2-0-4			
35	Marker Sleeve	TMS-SCE-1-2-0-4			
36	Connector	K20K08-041-10P			
37	Connector	D3899P26M30P			
38	Connector	D3899P26M18SA			
39	Connector	D3899P26M18P			
40	Filter Plug	M027488-20			

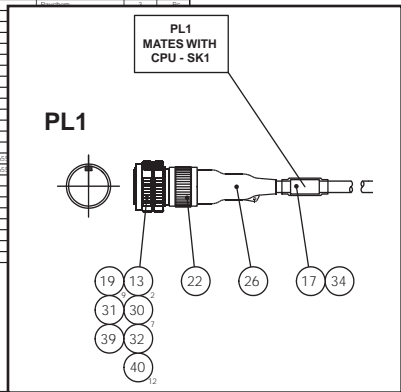

Parts Listing

During the parts listing process HarnWare software automatically:

- Extracts part details from the drawing
- Generates a sorted and totalized parts list table
- Adds item number balloons to the drawing cross referencing the parts to the parts list table.

HarnWare software parts list data can be written to a structured text file ready for use in a variety of other systems including spread sheets, databases or word processors. The parts lists for a number of harnesses can also be combined to form a composite parts list that totalizes all the parts for a set of harnesses on a project. Other parts listing options include the ability to:

- Retain existing item numbers when a design is modified.
- Include gaps in the item numbering sequence.
- Convert part numbers to customer numbers or to VG or other industry standard numbers.

Other Features

Among the other HarnWare software features and options are:

- 3D modelling system for visualizing harness designs. HarnWare software automatically generates to-scale 3D models which provide virtual prototypes of harnesses designed. The user can see what a harness will look like with lengths, diameters and parts shown to scale thus reducing the potential for errors.
- Lay-up (nail) board designs. Harness lay-up board design can be modeled with pegs automatically positioned along the harness legs. Drawn output can be used on the lay-up board.
- Weight calculation. Most components weights are stored in the HarnWare software database and this enables the software to estimate the weight of the harness.

2
Electrical Interconnection System Design

HarnWare Harness Design Software (Continued)

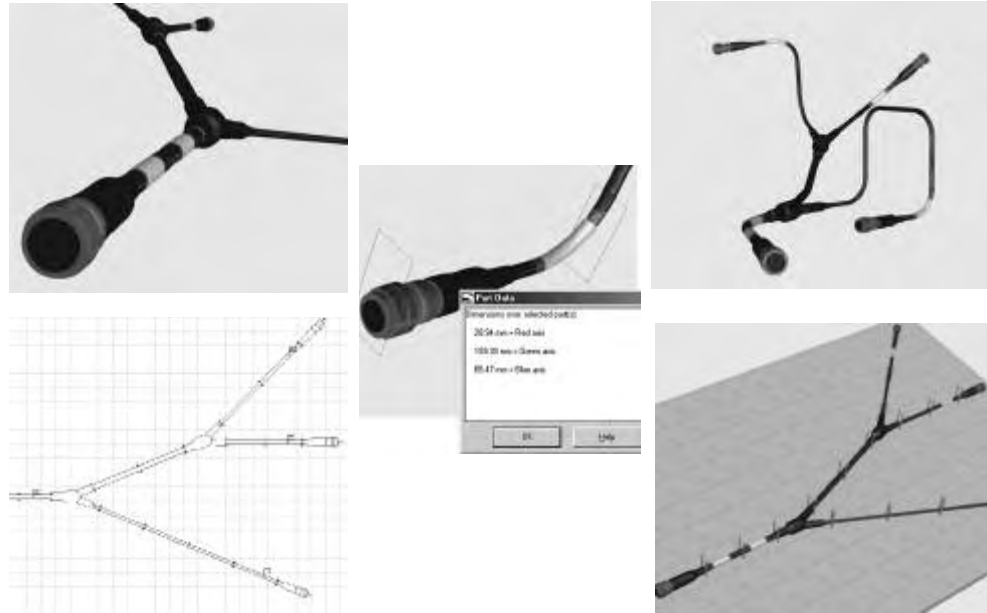

Other Features (Continued)

- **Labor estimator.** Harness drawings can be analyzed and details automatically added to a spread sheet containing assembly time standards. While estimating harness assembly times can never be an exact science, the estimates produced are sufficiently accurate for such purposes as comparing the cost effectiveness of alternative design solutions. A labor estimate is contained in the attached sample HarnWare software document set.
- **Cable analyzer.** This option analyzes the harness topology, wire lengths, etc. in order to suggest where machine, rather than hand, built cable sub-assemblies could result in the maximum cost savings.
- **Drawing translator.** Drawings can be translated into a number of foreign languages, including French and some Asian languages such as Korean and Japanese. Harnessing

- phrases, rather than individual words, are translated in order to achieve more meaningful and grammatically correct results.
- **Design checker.** This analyzes the contents and structure of a harness design against a set of rules. Where potential problems or deviations from 'best practice' are found, HarnWare software outputs a warning. The relevant parts in the harness design drawing can be flagged and the warning messages can also be listed in a table for use in design reviews. The warning flags and the messages are all linked to an on-line help system which contains further details on each specific problem.
- **Codes of practice.** A list can be generated of the codes of practice that are relevant to the parts included in the design. These describe harness assembly techniques and other issues.
- **On-line help system.** An extensive on-line help

- system covers system operating procedures and details on many aspects of harness design procedures and Raychem products. The help system is context sensitive and extensively cross-referenced using hyperlinks including links to the on-board manual or the Tyco Electronics website.
- **User parts library for non-standard parts.** A database to allow identification and retrieval of regularly used parts.
- **Multi-core cable database.** A database to allow selection of standard or regularly used cables.
- **Databus module.** Software for the design of MIL-C-1553 databus harness assemblies using Tyco Electronics components.
- **Conduit module.** Software for the design of Tyco Electronics conduit harnesses.

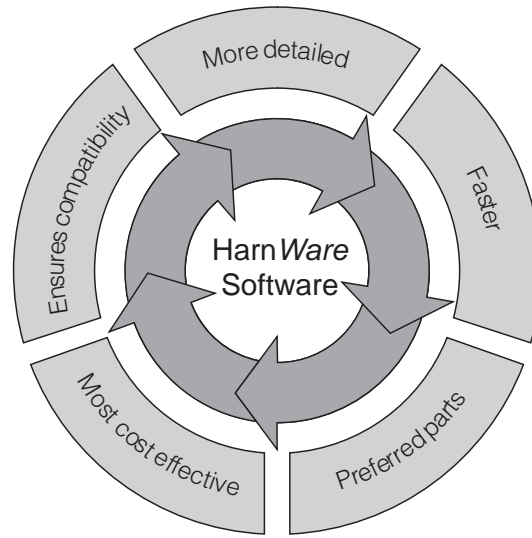

System Integration

HarnWare software can be linked to many other computer systems using a variety of interfaces including:

- Parts list data can be exported in structured text files suitable for reading by such systems as spread sheets, databases and word processors.
- Drawings can be imported and exported using industry standard formats such as DXF and IGES.
- Cable marker data can be transferred to marker printing systems such as Tyco Electronics WinTotal* system.
- Wiring connectivity data export for test equipment.
- X, Y coordinates of nail positions on lay-up (nail) board for NC drilling.

Benefits

The five key benefits of using HarnWare software are:

- 1) More detailed and accurate design.
- 2) Up to 20 times faster design and quotation.
- 3) Preferred part selection, to ensure best delivery and price.
- 4) More cost effective design.
- 5) Ensures parts are compatible with the intended service conditions and with mating parts.

Hundreds of users around the world can confirm the benefits of using HarnWare.

HarnWare Software

Document Set

The following partial set of drawings and associated documents is a simple example of what can be produced using HarnWare software.

*Tyco Electronics Identification product information available at www.tycoelectronics.com

General Assembly, Wiring Schematic, Parts List, Labor Estimate, Marker Sleeve and Codes of Practice Pages

HarnWare Harness Design Software (Continued)

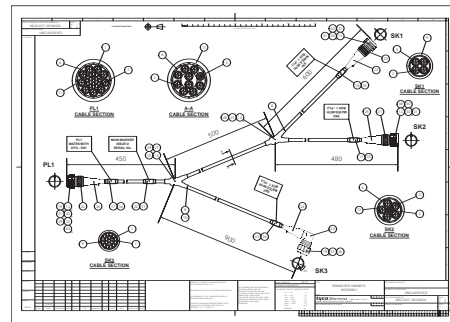

General Assembly

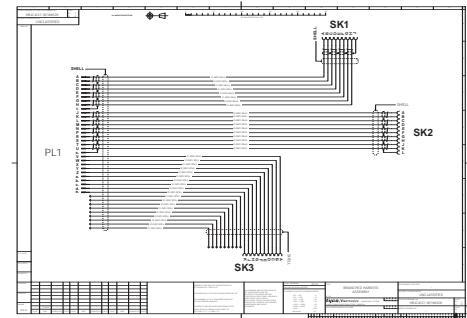

Wiring Schematic

PARTS LIST					
ITEM	DESCRIPTION	PART NUMBER	SPEC/REMARKS	QTY	UNIT
1	Wire	440311-20-9	Raychem	50.3	M
2	Wire	440311-20-54V-9	Raychem	15.5	M
3	Fiber	2.75-MM-SZF	Raychem	0.5	M
4	Fiber	3.50-MM-SZF	Raychem	0.5	M
5	Braid	BAV101-10.0	Raychem	1.2	M
6	Braid	BAV101-12.5	Raychem	1.2	M
7	Braid	BAV101-7.5	Raychem	1	M
8	Tubing	ATD99-4.3	Raychem	2	PL
9	Tubing	DR-25-1.0	Raychem	1.6	M
10	Tubing	DR-25-1.0-50MM	Raychem	1	PL
11	Tubing	DR-25-1.0	Raychem	1	M
12	Tubing	DR-25-3/4	Raychem	0.6	M
13	Tubing	RNF-100-1/2-0-20MM	Raychem	4	PL
14	Tubing	RNF-100-1/2-0-20MM	Raychem	3	PL
15	Tubing	RNF-100-1-0-20MM	Raychem	1	PL
16	Tubing	RF-375-1/2-4-45MM	Raychem	1	PL
17	Tubing	RF-375-1-3-65MM	Raychem	3	PL
18	Tubing	RF-375-3/4-4-65MM	Raychem	1	PL
19	Insulation Cap	TC4003-9	Raychem	18	PL
20	Adaptor	TR4048B03-1208A	Raychem	1	PL
21	Adaptor	TR4048B03-1430A	Raychem	1	PL
22	Adaptor	TR4048B03-2014A	Raychem	1	PL
23	Adaptor	TR4048B03-1208A	Raychem	1	PL
24	Moulded Part	252K142-25225-0	Raychem	2	PL
25	Moulded Part	252K153-25225-0	Raychem	1	PL
26	Moulded Part	252K163-25225-0	Raychem	1	PL
27	Moulded Part	302A214-25225-0	Raychem	2	PL
28	Solder Device	B-051-02-01	Raychem	1	PL
29	Solder Device	B-051-02-01	Raychem	1	PL
30	Solder Device	S183-15-20-95	Raychem	14	PL
31	Marker Sleeve	TMS-NR501-NR79-4-CS-45571	Raychem	4	KT
32	Marker Sleeve	TMS-NR501-NR79-4-CS-45572	Raychem	1	KT
33	Marker Sleeve	TMS-SCE-1/2-2-0-4	Raychem	1	PL
34	Marker Sleeve	TMS-SCE-1/2-2-0-4	Raychem	2	PL
35	Marker Sleeve	TMS-SCE-3/4-2-0-4	Raychem	2	PL
36	Connector	42GB-54712-19P	Amphenol	1	PL
37	Connector	D38999-268G268P	M.L.C. 38999	1	PL
38	Connector	D38999-268G126A	M.L.C. 38999	1	PL
39	Connector	D38999-268G417P	M.L.C. 38999	1	PL
40	Fiber Plug	M527488-20	-	20	PL

tyco/Electronics
HARNESSES PROPOSAL DRAWING

FILE: BRANCH-ED HARNESSES ASSEMBLY
CREATOR: D.Hammoud DATE: 13/03/01
FILENAME: Pcham.vsd Page 2 of 8
Printed 13/03/01 13:16:41

LABOUR ESTIMATE					
Element	Time (mins)	Qty / Length	Total mins	Element	Time (mins) Qty / Length Total mins
Unpack Check kit	15	per kit	0		
Cut FPC to Length	1	per meter	0		
Jacket Stripping	5	per end	4	20	Raychem 121 to 142 17 per piece 0 0
Remove FPC Jacket	5	per end	0	0	151 to 163 32 per piece 0 0
Identify Wires	1.3	per wire	60	76	174 50 per piece 0 0
Strip/Crimp/Heat	2.5	per cord	50	125	
Solder Wires					
Up to 12AWG (Typical/Insulated)	5.5	per term	10	35	Standard 1 to 62 12 per piece 2 24
14 to 12AWG (Typical/Insulated)	5	per term	0	0	53 to 63 15 per piece 2 30
Power Cable	15	per term	0	0	64 20 per piece 0 0
Light Crimp	15	per term	0	0	65 to 66.5 15 per piece 0 0
Light Solder	15	per term	0	0	
KTOK					
Repair Loops	0.5	per wire	40	30	KTOK 5 per piece 0 0
Up to 55 Way Con. Above 55 Way Con.	0.75	per wire	0	0	Molded 6 per piece 0 0
					Large 7 per piece 0 0
Transitions					
3 Outlets					
1 to 3/4					16 per piece 0 0
2 to 4/8					20 per piece 2 40
3 to 6					23 per piece 0 0
4 Outlets					
1 to 1/4					21 per piece 0 0
2 to 4/8					25 per piece 0 0
3 to 6					29 per piece 0 0
5 Outlets					
1 to 1/4					25 per piece 0 0
2 to 4/8					33 per piece 0 0
3 to 6					37 per piece 0 0
4 to 8					42 per piece 1 42
5 to 10					51 per piece 1 51
Adaptors (includes Braid Term / Torque)					
Spin Crimping	1.5	per term	0	0	
Braid Adaptor	12	per term	0	0	
Wire Crimping	12	per term	5	60	
Wire Splicing	12	per term	5	60	
Tubing					
800S - 1/4	4	per meter	0	0	
14 to 1/2	7	per meter	1.50	10.5	
24 to 1/2	10	per meter	1.43	14.3	
1 1/2 - 1/2	15	per meter	0	0	
ZHTU +25%	0.2	1 for no.	0	0	
CPPT +25%	-25	1 for no.	0	0	
CPPT +25%	-25	1 for no.	0	0	
Tubing Installation (on Mark Log Harness)	1	per	2.93	5.86	
Wire Layout					
Loop <= 4 Meters	1		27.38	27.38	
> 20 wires	1.5		12.60	18.9	
> 30 wires	2		0	0	
Loop <= 4 Meters	1.5		0	0	
> 20 wires	2		0	0	
> 30 wires	2.5		0	0	
Enter 1 to add 30% for rework wire stock	1				
Enter 1 to Add Allowances for Prototypes:					
20% for Straight or Branched < 4 Ends	0				
35% for Branched < 4 Ends	0				
Total Labour Time (hours) 11.33					
Labour rate per hour 0.00					
Total Labour Cost £ 0.00					

tyco/Electronics
HARNESSES PROPOSAL DRAWING

FILE: BRANCH-ED HARNESSES ASSEMBLY
CREATOR: D.Hammoud DATE: 13/03/01
FILENAME: Pcham.vsd Page 5 of 8
Printed 13/03/01 13:16:41

MARKER PAGE	
<p>PL1 MATES WITH CPU - SK1</p> <p>Item:34 Quantity:1 Part Number:TMS-SCE-1-2-0-4 Colour:Yellow Font:10 cpl Standard</p>	<p>SK1 MATES WITH BOX 1 - PL1</p> <p>Item:35 Quantity:1 Part Number:TMS-SCE-3/4-2-0-4 Colour:Yellow Font:10 cpl Standard</p>
<p>MAIN MARKER ISSUE # SERIAL No.</p> <p>Item:34 Quantity:1 Part Number:TMS-SCE-1-2-0-4 Colour:Yellow Font:10 cpl Standard</p>	<p>SK2 MATES WITH BOX 1 - PL2</p> <p>Item:35 Quantity:1 Part Number:TMS-SCE-3/4-2-0-4 Colour:Yellow Font:10 cpl Standard</p>
	<p>SK3 MATES WITH BOX 1 - PL3</p> <p>Item:33 Quantity:1 Part Number:TMS-SCE-1/2-2-0-4 Colour:Yellow Font:10 cpl Standard</p>

tyco/Electronics
HARNESSES PROPOSAL DRAWING

FILE: BRANCH-ED HARNESSES ASSEMBLY
CREATOR: D.Hammoud DATE: 13/03/01
FILENAME: Pcham.vsd Page 6 of 8
Printed 13/03/01 13:16:41

CODES OF PRACTICE, FAX-ON-DEMAND AND DRAWING NOTES	
Codes of Practice:	Description
251	End stripping primary wire and cable
254	Stripping wire and cable jackets
256	Laying hand laid sections of harnesses
257	Applying Kevlar binder to hand-laid sections of harnesses
261	Preparing shielded and jacketed wire
301	Looping wire gauges 18 and below
368	Terminating a primary wire to a cable shield using a solder sleeve with a pre-installed lead
361	Applying a single layer of braid to a hand laid cable
363	Terminating overall shields for med by single layers of braid at a transition
610	Preparing cable jackets for the installation of pre-couted tubings
261	Installing Tinel-Lock rings with a resistance heater
366	Positioning Tinel-Lock rings
451	Applying Loctite sealants to Raychem adaptors
452	Torque tightening Raychem adaptors
553	Installing medium and large transitions
554	Installing straight lipped boots
557	Under jacket packing for moulded parts
559	Installing moulded parts using Unicure adhesive
603	Preparing cable jackets and adaptors for installing moulded parts
609	Preparing non-shielded moulded parts
556	Installing marker sleeves
454	Checking the retention of pins or sockets within a connector

tyco/Electronics
HARNESSES PROPOSAL DRAWING

FILE: BRANCH-ED HARNESSES ASSEMBLY
CREATOR: D.Hammoud DATE: 13/03/01
FILENAME: Pcham.vsd Page 8 of 8
Printed 13/03/01 13:16:41



Assembled military harness.



Military harness system components.

Raychem integrated harness systems have been developed for a wide range of defense and industrial applications. Each system consists of compatible components, including cable jackets, heat-shrinkable components, and adhesives. Performance of these parts is assured because all components are tested separately and as part of an assembled system (see photo top left).

A typical designed harness consists of seven component parts (pictured at right):

1. Primary wire and cable
2. Heat-shrinkable tubing
3. Backshell adapter
4. Molded part
5. Adhesive
6. Cable jacket
7. Marker sleeve*

Additional components for harnessing systems include the following:

- A wide range of special devices, such as SolderSleeve devices for primary wire interconnection.
- A selection of electrical shielding (screening) options, including braids and termination assemblies.
- Multiconductor (multi-core) cables.
- Specialty adhesives and sealants for complete environmental sealing.**

Table 1 on the next page serves as both a summary of Raychem products for specific harnessing systems and a selection table for harnessing system components. An explanation of how to select components for a harness system follows.

*Tyco Electronics Identification products information available at www.tycoelectronics.com

**Tyco Electronics Sealant product information available at www.tycoelectronics.com

Table 1. Raychem Harnessing Systems and Their Components

Integrated Military Harness Systems for Defense and Allied Industries (Continued)

Components	System 10	System 20	System 25	System 30	System 100	System 200	System 300
Wire	44	44	44	55	99, 100A, 100G	55	55
Tubing	Versafit	NT-FR	DR25	VPB	ZHTM	Viton®	RT555
Adapter material and plating finish chosen for compatibility with the connectors.							
Molded part	-3, -4, -71	-51	-25	-50	-100	-12	-55/-125
Preinstalled Rayaten molded part	-35	—	-25S	—	-100S	—	—
Adhesive	S1017, S1030	S1124, S1048	S1048, S1125	S-1125, S-1255-04	S1030, S1125,	S1125, S1255	S1255-04
Precoated adhesive	/42, /180	/164, /86	/86, /225	—	/180	—	—
Conductive adhesive	—	—	S1184	—	S1184	—	—
Cable jacket	Thermorad	NT-FR	FDR-25	Thermorad VPB	Zerohal	Viton®	RT555
Marker sleeve*	TMS-SCE	TMS-SCE	TMS-SCE	TMS-SCE	HX-SCE	HT-SCE	HT-SCE

*Tyco Electronics Identification products information available at www.tycoelectronics.com.

Selection Process

Selecting the components for a harnessing system is a four-step process:

Step 1: Select the material system appropriate for the operating conditions and environment to which the harness will be exposed.

Step 2: Select the adhesive system appropriate for the material system you select in Step 1.

Step 3: Determine the level of EMI shielding required.

Step 4: Select the components.

Each step is described on the pages that follow. A selection table accompanies each step. You can also use HarnWare software to design your harness.

Step 1. Select the Material System.

Detailed in Table 2 on the next page are the major material systems for use in a wide range of operating conditions and environments.

Choose a material system that:

- Has the physical characteristics your harness requires.
- Will accommodate the operating temperature and the fluids and abuse to which the harness will be exposed.

VITON is a trademark of Dupont Dow Elastomers LLC

Table 2. Material System Selection

	System 10	System 20	System 25
Operating temperature	-20°C to +60°C [-4°F to +140°F]	-55°C to +121°C [-67°F to +250°F]	-75°C to +150°C* [-103°F to +302°F]
Physical characteristics	<ul style="list-style-type: none"> Environmentally sealable Lightweight Small diameter Flexible 	<ul style="list-style-type: none"> Environmentally sealed Tough Flexible Low profile 	<ul style="list-style-type: none"> Environmentally sealed Rugged Abrasion-resistant Very flexible
Flammability	<ul style="list-style-type: none"> Flame-retardant Self-extinguishing 	<ul style="list-style-type: none"> Flame-retarded Self-extinguishing 	<ul style="list-style-type: none"> Flame-resistant Self-extinguishing
Fluid resistance	<ul style="list-style-type: none"> Resists common industrial and military cleaning solvents and degreasers. 	<ul style="list-style-type: none"> Resists most commonly used military fuels, oils, and greases 	<ul style="list-style-type: none"> Resists most common military fuels, oils, and greases. up to 70°C [158°F].
Typical applications	<ul style="list-style-type: none"> Used in high-performance industrial applications, and in military communication and test equipment. 	<ul style="list-style-type: none"> Specially suited to military vehicles and engine compartments, low profile shapes save space and weight. 	<ul style="list-style-type: none"> Specially suited to military vehicles, aerospace and marine applications, and communication and test equipment.

	System 30	System 100	System 200
Operating temperature	-55°C to +150°C [-67°F to +302°F]	-30°C to +105°C [-22°F to +221°F]	-55°C to +200°C [-67°F to +392°F]
Physical characteristics	<ul style="list-style-type: none"> Environmentally sealed Tough Flexible Low profile 	<ul style="list-style-type: none"> Environmentally sealed Flexible 	<ul style="list-style-type: none"> Environmentally sealed Very flexible
Flammability	<ul style="list-style-type: none"> Flame-retarded Self-extinguishing 	<ul style="list-style-type: none"> Low toxicity index (as defined by NES-13) Low smoke emission (as defined by NES-711) Low corrosive gas evolution 	<ul style="list-style-type: none"> Highly flame-retardant
Fluid resistance	<ul style="list-style-type: none"> Resists most of commonly used military fuels, oils, and greases. 	<ul style="list-style-type: none"> Resistant to a range of military fuels, oils, and greases. 	<ul style="list-style-type: none"> Resists long-term immersion in military fuels, oils, and greases at elevated temperatures.
Typical applications	<ul style="list-style-type: none"> Specifically suited to military vehicles and engine compartments for higher temperature applications, low profile shapes save space and weight. 	<ul style="list-style-type: none"> Specially suitable for confined habitat areas in military and civil applications. Extensively used in surface and submarine vessels and underground railways 	<ul style="list-style-type: none"> Used where there is prolonged exposure to high temperatures. Used where a harness may be permanently immersed in difficult fuels, such as in fuel tanks.

	System 300
Operating temperature	-55°C to +200°C [-67°F to +392°F]
Physical characteristics	<ul style="list-style-type: none"> Environmentally sealed Highly abrasion resistant Low profile
Flammability	<ul style="list-style-type: none"> Highly flame-retardant
Fluid resistance	<ul style="list-style-type: none"> Performs in aggressive fluids at extremely high temperatures
Typical applications	<ul style="list-style-type: none"> Permanent immersion in aggressive fluids

*Per VG 95343.



Integrated Military Harness Systems for Defense and Allied Industries (Continued)

Components	System 770	System 780	System 790
Wire	44	55	55
Tubing	RT-770	RT-780	RT-790
Molded part	-770	-780	-790/-791
Adhesive	S-1264	S-1255-04	S-1255-04
Marker sleeve cover	RT-375	RT-375	RT-375
Marker sleeve**	TMS-SCE	NBC-SCE	NBC-SCE

**Tyco Electronics Identification products information available at www.tycoelectronics.com.

Material System Selection

	System 770	System 780	System 790
Operating temperature	-55°C to +125°C [-67°F to +257°F]	-65°C to +175°C [-85°F to +347°F]	-65°C to 200°C [-85°F to +392°F]
Physical characteristics	<ul style="list-style-type: none"> Environmentally sealed NBC resistant Flexible 	<ul style="list-style-type: none"> Environmentally sealed NBC resistant Flexible 	<ul style="list-style-type: none"> Environmentally sealed NBC resistant Flexible
Flammability	<ul style="list-style-type: none"> Flame retarded Self-extinguishing 	<ul style="list-style-type: none"> Flame retarded Self-extinguishing 	<ul style="list-style-type: none"> Flame retarded Self-extinguishing
Fluid resistance	<ul style="list-style-type: none"> Resistant to NBC uptake and decontamination 	<ul style="list-style-type: none"> Resistant to NBC uptake and decontamination 	<ul style="list-style-type: none"> Resistant to NBC uptake and decontamination
Typical applications	<ul style="list-style-type: none"> Base-line system for NBC resistant applications 	<ul style="list-style-type: none"> High temperature system for NBC resistant applications 	<ul style="list-style-type: none"> Extreme high temperature system for NBC resistant applications

Adhesive Selection

Material System	Adhesive Type	Component Adhesive	Precoated Adhesive Designation	Service Temperature
System 770	Two-part Epoxy	S-1264	—	150°C
System 780	Thermoset tape	S-1255-04	—	200°C
System 790	Thermoset tape	S-1255-04	—	200°C

*Under Development - contact Tyco Electronics for additional information

Integrated Military Harness Systems for Defense and Allied Industries (Continued)

Step 2. Select the Adhesive System.

Two types of adhesives are used to bond heat-shrinkable boots and transitions to tubing or wire jacketing:

- Thermosets, which include epoxies and other two-part systems.
- Thermoplastics, which include pre-coated meltable adhesives applied to parts during manufacture and those applied as meltable tapes during assembly.

Table 3 below outlines the differences between thermosets and thermoplastics.

Table 4 shows which adhesive type is appropriate for each harness material system.

Table 3. Comparison of Adhesive Types

	Thermoset	Thermoplastic
Method of adhesion	Cures through chemical reaction.	Melts, flows, and solidifies.
Application	Two-part types require mixing and application at assembly.	Precoated types require no preparation at assembly.
Cure time	Varies with cure temperature. Oven cure usually desirable.	Not required. Adhesive functional when cooled to room temperature.
Strength	Retains most strength at elevated temperatures.	Loses strength as melt temperature is approached.
Disassembly	Items can be forcibly peeled apart when heated sufficiently.	Items can be separated when heated to temperature of the adhesive.
Repair/reassembly	Requires new adhesive or hot rollback to reenter behind connector without affecting adhesive bonds.	Can be reheated to form new bond if sufficient adhesive remains.

Table 4. Adhesive Selection

Material System	Adhesive Type	Component Adhesive	Precoated Adhesive Designation	Service Temperature
System 10	Thermoplastic	S-1030	/180	80°C
		S-1017	/42	60°C
System 20	Thermoplastic	S-1124	/164	105°C
		S-1048	/86	120°C
System 25	Thermoplastic	S-1048	/86	120°C
	Two-part thermoset	S-1125	/225	150°C
System 30	Thermoset Tape	S-1255-04	—	200°C
	Two-part thermoset	S-1125	—	150°C
System 100	Thermoplastic	S-1030	/180	80°C
		S-1048	/86	120°C
		S-1125	—	150°C
System 200	Two-part thermoset	S-1125	—	150°C
	Thermoset tape	S-1255-04	—	200°C
System 300	Thermoset tape	S-1255-04	—	200°C
System 770	—	S-1264	—	—
System 780	Thermoset tape	S-1255-04	—	200°C
System 790	Thermoset tape	S-1255-04	—	200°C

Step 3. Determine the Level of EMI Shielding Required.

Tyco Electronics offer several methods and technologies for controlling electromagnetic interference (EMI) and noise in cable harnesses. Developed in response to well-established threats in military and other harsh environments, these technologies can be employed in compatible shielding (screening) systems to achieve the level of shielding required for a harness system. Table 5 on page 2-22 outlines the shielding requirements for various types of threat and levels of interference.

Introduction

This section is intended as a guide for the use of harness designers who are required to achieve a level of EMI control in their design practices. It is not intended that it should be a definitive statement on all aspects of EMI control for harnesses. In case of difficulty contact us for further clarification or consultancy.

For well-designed EMI control of electrical systems it is essential that a detailed knowledge of the system requirements and susceptibility be obtained. The chosen level of shielding will be dependent on the:

- Susceptibility of electrical system.
- Types of components used.
- Physical layout of the system.
- Equipment practices adopted.
- Anticipated EMI threat.

For the most cost effective design of harnesses, which offer a long-term stability in performance, the system should be designed to achieve a balance of component characteristics. Components should only be used if they are qualified to a minimum level of EMI performance and the performance and test method should be applicable to the design technique being used.

For quality assurance purposes minimum EMI characteristics should always be specified and for critical harnesses the complete performance should be measured. The technique to be adopted should always be specified.

Finally the inter-relationship between harnesses and the protection, termination and grounding of equipment boxes is vital for good system performance against EMI. All components form part of the external shield on the system and therefore should be considered in the overall EMI design process.

Subjects covered in this topic are:

- Harness Types - point to point and branched
- Shielding Levels - calculations

Harness Types

Harnesses are divided into two types, point-to-point and branched. The advantages and disadvantages of each from an EMI control standpoint are described below. No attempt has been made to analyze their relative merits in mechanical or installation terms.

Point To Point:

The three major components of this type of harness are: connectors, cable, and connector accessories.

Connectors

There are many different types of circular military connectors. However, for a well-shielded harness only those connectors having a guaranteed performance level should be used e.g. MIL-C-26482 Series II and MIL-C-38999 series 1 and 2, and series 3 and 4.

Cable

Cable used in this type of harness is generally machine made. Hand laid cables may also be used but generally the shields incorporated in these harnesses vary in consistency of performance. In the case of machine made cables all shields should be designed for optimum shielding effectiveness at radio frequency.

Connector Accessories

Connector accessories, such as Raychem adapters, are available in many styles and therefore their performance varies with construction. For a level of consistency in performance it is essential that, as with connectors, a guarantee in performance level be achieved. Fittings not specified in this way may significantly degrade the overall system performance.

Branched

In addition to those components described above, branched harnesses include transitions. This type of harness is usually made by hand and it is therefore difficult to incorporate accurately made machine fabricated shields. The implications of this are:

Shields

Cable shields may be put on by hand or by feeding through a braiding machine. However, as braid optimization depends on all the constructional parameters of the braid being accurately specified, unless braid is well constructed the shielding performance can suffer dramatically. Reductions in shield performance of 20-40 dB have been measured on badly made branched harnesses. The alternative method is to use pull on braids. If the cable bundle diameter is known the braid may be designed for optimized performance.

Transitions

Transitions, as with accessories, are very susceptible to performance variability with construction type.

For high performance harnesses these components should also have a guaranteed performance.

In general the use of techniques such as hand soldering or the use of butted tape wraps are not recommended except where only a low performance of less than 40dB is required.

Shielding Levels and Component Performance

System Performance

To specify the overall requirements of a complete electronic system in terms of its EMI characteristics it is necessary to consider the performance of the individual components parts. The harnesses form one of the major entry points for interference and this as such can degrade a complete system performance by a significant amount. In general terms, assuming that a shielded harness system is used, with the available components on the market the overall harness system performance and typical applications may be as below.

- 40 to 50 dB Standard shielded systems for insensitive systems.
- 50 to 60 dB Military standard shielded systems for general applications.
- 60 to 80 dB As above but where full threat EMP & TEMPEST protection is required.
- 80 to 100 dB Severe TEMPEST and very sensitive systems.
- Over 100 dB Exceptional shielding requirements only.

Shield performance is specified in two ways, either as a power relationship in decibels (dB) or as an absolute measurement of the shield performance in terms of the surface transfer impedance. Except for very specific low frequency problems it is general to specify the performance at frequencies in the range 0.1MHz to 100MHz.

Safety Margins

As with all designs EMI system design should not be performed to the "limit of performance safety margin should always be incorporated when determining the minimum shielding level appropriate for consistent operation of the system.

The inter-relationship of shielding effectiveness measured in decibels and the surface transfer impedance in ohms presents the designer with a conversion difficulty. External harness circuits vary, as do the coupling characteristics and it is therefore only possible to give an approximate conversion. The normal conversion from decibels to ohms and vice versa is to a reasonable approximation:

$$\text{Screening Effectiveness (dB)} = 36 - 20 \log_{10} (Z_r \text{ (Ohms)})$$

The constant term is developed from the expressions for the characteristic impedance of the line formed by the harness shield and the ground plane and the internal characteristic impedance of the inside of the harness. The translation from shielding effectiveness to surface transfer impedance is shown below in Table 5 for S.E. from 20 to 105dB.

Connectors

A study of those connector specifications having an EMI test shows that they are generally specified in the frequency band 100MHz to 1GHz. For an assessment at lower frequencies the low frequency performance as dictated by the d.c. resistance of the connector is required. These two parameters enable the EMI characteristic to be made of the complete connector performance. Typical values for standard connectors are 65dB (MIL-C-26482 Series II) and 90dB (MIL-C-38999 Series III) connectors.

Table 5 - Screening Effectiveness (SE)/Surface Transfer Impedance (Zt) Relationships

S.E. (dB)	Z _t (ohms)	S.E. (dB)	Z _t (ohms)
20	6.309	65	0.0355
25	3.548	70	0.0200
30	1.995	75	0.0112
35	1.122	80	0.0063
40	0.631	85	0.0036
45	0.355	90	0.0020
50	0.200	95	0.0011
55	0.112	100	0.0006
60	0.063	105	0.0004

Cable

In accordance with most common cable specification the shielding performance of a cable is specified at 30MHz. It is also well into the band where inductive leakage is the primary penetration characteristic. For frequencies above or below 30Mhz, approximations, as for connectors, must be made. It should be noted that the performance specified at 30MHz in Table 6 for different cable types is the maximum that is allowed using Tyco Electronics' standard Q.C. values. Actual performance may be up to 20dB better.

Connector Accessories and Transitions

In constructional terms the performance of the connector accessory includes both the resistive terminations to the cable shield and the connector. However, it is most unusual to specify the performance of an accessory and this is a distinct weakness in the design of harnesses. The reason is that the performance is extremely variable as accessories have to fit a variety of different cable sizes and shapes. Where specified at all the relationship between the test method and the coupling mechanism for the EMI must be considered.

Table 6 - Cable Performances

Type of Screen	Diameter under screen (mm)	Surface transfer Impedance Zt @ 30 Mhz (maximum)
Single optimized braid	Up to 7.5	100 milli ohms/metre
	7.6 and up	50 milli ohms/metre
Double optimized braid	Up to 7.5	10 milli ohms/metre
	7.6 and up	5 milli ohms/metre
Superscreened (2 braids + 1 wrap)	Up to 7.5	100 micro ohms/metre
	7.6 and up	50 micro ohms/metre

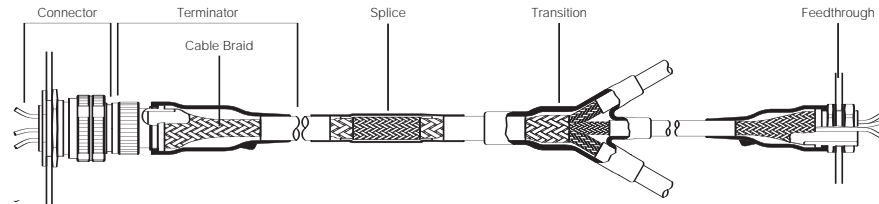

Complete Harness

When considering the complete harness the coupling calculations are relatively simple. In general terms they are the addition of all the individual leakages within the system from connector to connector. The analysis route is therefore as follows:

1. Convert all decibel values at the desired frequency to surface transfer impedance.
2. Choose components for a 'balanced' system, i.e. the components should have approximately the same performance.
3. Add the values determined for surface transfer impedance of the components at the frequency chosen.
4. Reconvert to decibels if necessary. (Table 5 can be used for this purpose)

As a guide to the shielding performance that can be expected from a harness that is constructed using Raychem components, Table 7 on the next page has been compiled to help in the product selection process.

For branched harnesses it is necessary to determine whether every branch has the same susceptibility requirements or carries the same signals of power. The performance requirement of each branch is then determined and the matrix for the harness established. This is a more complex subject and not discussed here. System improvements may be achieved by changing either the connectors or cable. In general terms changing from a single to a double optimized braid improves the performance of that component by 20-25 dB. A similar advantage is achieved by changing from MIL-C-26482 Series II to MIL-C-38999 Series I connectors. However, the relative significance, as part of the system, of each component must be considered to determine the true weighting effect. For the optimum in system design a balance of component performances should be achieved wherever possible such that each of the components is of similar performance level.

General Considerations

Although cables and harnesses are considered to be the most significant in terms of coupling into systems the construction of equipment boxes can play an important part in the overall EMI performance of a system. With the increasing use of high speed digital circuits and the generation of harmonics having high energy content relatively short printed circuit board tracks can radiate or pick up energy as efficiently as cables. If the boxes themselves are not adequately protected these circuits may constitute an EMI threat. There is a further area of significance in the EMI protection of the boxes and this is the connector/box interface. The junction may be considered to be a part of the harness system and any degradation in it may cause an overall harness degradation.

Table 7 - Screen System Guide

Shielding Level Required	Connector	Adapter Styles		Termination		Cable Braid (max. length in m/ft) (by cable construction)					Transition	Splice	Feed-through
		Band Strap	Braided	Tinel-Lock System	Rayaten Assembly	NO	SO	DO	SSS	DSS			
<60 dB	VG95328 VG95234	■	■	■	—	<2/6.5	15/49	100/328	—	—	Shield tape & Solder-Sleeve device	Solder-Sleeve device	Tinel or solder devices
60 to 80 dB	MIL-C-26482 Series 2 VG96912 Series 1	—	—	■	—	—	<2/6.5	7/22.9	100/328	—	Shield tape & Solder-Sleeve device	Solder-Sleeve device	Tinel or Rayaten assembly
>80 dB	MIL-C-38999	—	—	—	■	—	—	<0.5/1.6	50/164	65/213	Not recommended	Solder-Sleeve device	Tinel or Rayaten assembly

NO = Non Optimized, SO = Single Optimized, DO = Double Optimized, SSS = Single Super Shield, DSS = (TYCO must provide info)
Note:

- The cable lengths are to be used as a guide. Outside 30 MHz, the lengths that can be used will vary. For specific harness design outside 30 MHz, please consult Tyco Electronics.
- Tinel-Lock use at shielding levels of 60–80 dB depends on the adapter entry, cable braid size, and design. For further details, contact Tyco Electronics.
- Connectors commonly used but not mentioned in the table may not have a stated shielding performance in their specification. Contact the manufacturer for guidance.
- This guide makes no allowance for the possible effects of resonance. Tyco Electronics should be consulted for advice on compensating for resonance.

Step 4. Select Components

Using the previous sections, you can now select all of the components for an integrated harness assembly.

Please refer to the sections listed for more detailed component information:

Molded PartsSection 4
 Wire and CableSection 9
 AdaptersSection 6
 AssembliesSection 7
 Electrical Interconnect ProductsSection 8
 TubingSection 3

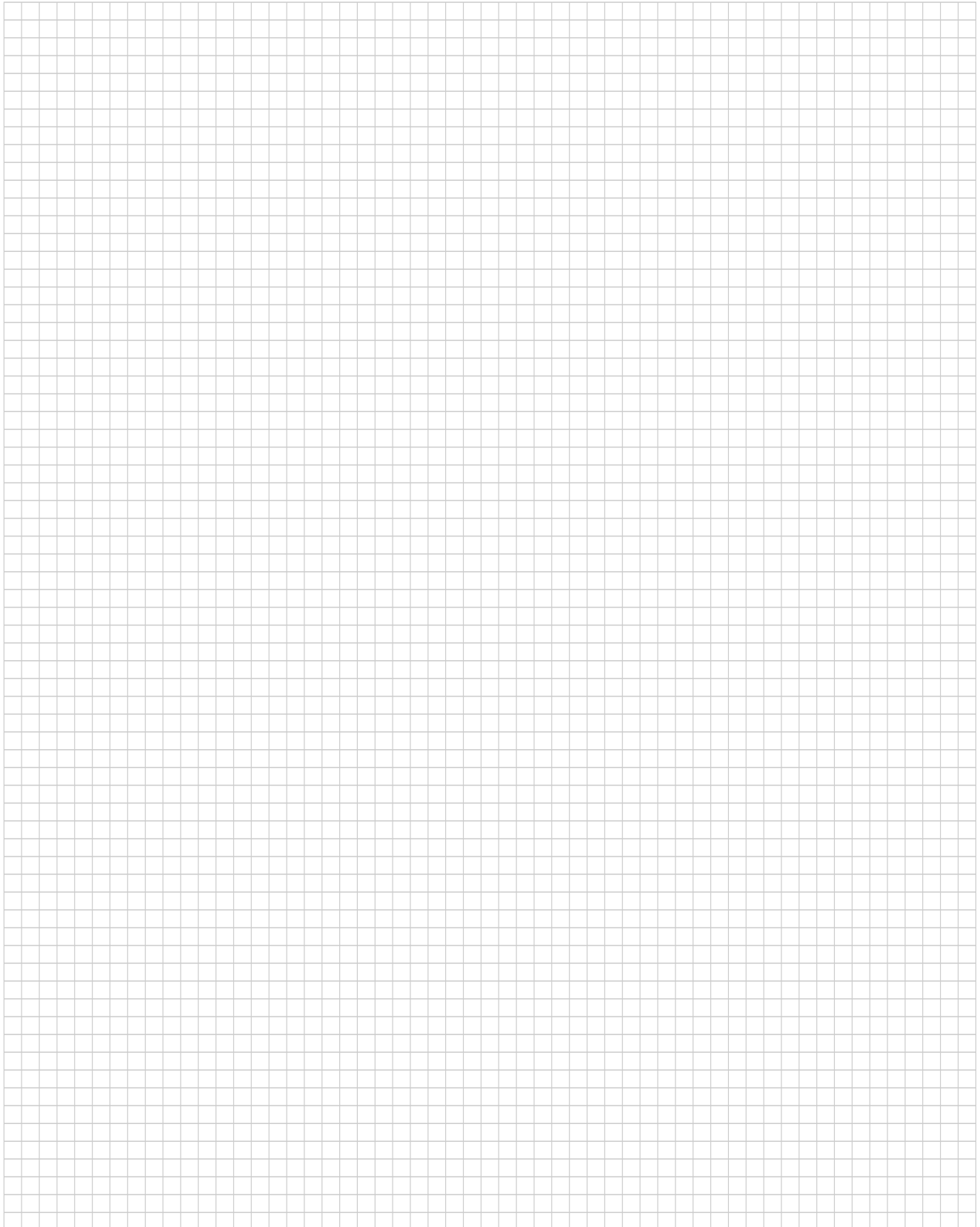

Table of Contents

Overview 3-3

Tubing Categories 3-3

Tubing Selection Guide 3-4, 3-5

Specification Cross-Reference Guide 3-6

Single Wall Tubing

CGPE-105 Brightly colored, shiny, non-flame-retardant polyolefin tubing .3-7, 3-8

CGPT General purpose, flame-retardant, polyolefin tubing 3-9, 3-10

CRN Semirigid, flame-retardant, polyolefin tubing 3-11, 3-12

DCPT Flexible, flame-retardant, dual-color, polyolefin tubing 3-13, 3-14

LSTT Low-shrink-temperature, non-flame-retardant, heat-shrinkable, polyolefin tubing 3-15, 3-16

RNF-100 Flexible, flame-retardant, general purpose, polyolefin tubing 3-17, 3-18

RNF-3000 Flexible, high-shrink-ratio, flame-retardant, general purpose, polyolefin tubing 3-19, 3-20

RP-4800 High-shrink-ratio, flame-retardant, polyolefin tubing 3-21, 3-22

RT-3 Semirigid, flame-retardant, polyolefin tubing 3-23, 3-24

TUGA-GP Brightly colored, shiny, non-flame-retardant, polyolefin tubing 3-25, 3-26

Versafit Highly flame-retardant, very flexible, low-shrink-temperature, polyolefin tubing 3-27, 3-28

Versafit V2 Highly flame-retardant, very flexible, low-shrink temperature, polyolefin tubing 3-29, 3-30

Versafit V4 Very-thin-wall, very flexible, highly flame-retardant, polyolefin tubing 3-31, 3-32

Dual Wall Tubing (Adhesive and Encapsulant-Lined)

ATUM High-shrink-ratio, adhesive-lined polyolefin tubing 3-33, 3-34

DWP-125 Flexible, high-shrink-ratio, adhesive-lined, polyolefin tubing 3-35, 3-36

ES1000 Clear, high-shrink-ratio, adhesive-lined, semirigid polyolefin tubing 3-37, 3-38

ES2000 Flame-retardant, high-shrink-ratio, adhesive-lined, semirigid polyolefin tubing 3-39, 3-40

FL2500 Fully flame-retardant, adhesive-lined, polyolefin heat-shrinkable tubing 3-41, 3-42

HTAT Semiflexible, dual wall, moisture-resistant, heat-shrinkable tubing 3-43, 3-44

RPPM Flexible, dual wall, moisture proof, heat-shrinkable tubing 3-45, 3-46

SCL Semirigid, encapsulant-lined, polyolefin tubing 3-47, 3-48

SCT Flame-retardant, adhesive-lined, semirigid polyolefin, heat-shrinkable tubing (extended temperature range) 3-49, 3-50

TAT-125 Adhesive-lined, flexible polyolefin tubing 3-51, 3-52

Heavy Duty Tubing

BSTS/BSTS-FR General purpose, heat-shrinkable tubing 3-53, 3-54

HF High-flex, heavy-wall, heat-shrinkable tubing 3-55, 3-56

HRHF/HRNF/HRSR High-ratio, heat-shrinkable tubing 3-57, 3-58

RHW Rugged, heavy wall, adhesive-lined, polyolefin heat-shrinkable tubing 3-59, 3-60

RMW Medium wall, polyolefin heat-shrinkable tubing 3-61, 3-62

SST/SST-FR Self-sealing, heat-shrinkable tubing 3-63, 3-64

Note: Users should independently evaluate the suitability of the product for their application. Before ordering, check with Tyco Electronics for most current data.

Table of Contents (Continued)

Special Purpose Tubing

DR-25	Heat-shrinkable, flexible, chemical and abrasion resistant tubing	3-65, 3-66
ES Caps	High-shrink-ratio, adhesive-lined, semirigid polyolefin caps	3-67, 3-68
HCTE	Helical convolex tubing with a high crush resistance	3-69, 3-70
HFT5000	Heat-shrinkable fabric tubing	3-71, 3-72
MicroFit	Small-diameter, high-shrink-ratio tubing	3-73, 3-74
MT1000	Altera medical-grade, USP Class VI, high-temperature, semirigid, fluoropolymer tubing	3-75, 3-76
MT2000	Altera medical-grade, USP Class VI, lubricious, thin-wall, polyolefin tubing	3-77, 3-78
MT3000	Altera medical-grade, USP Class VI, high-temperature flexible, fluoropolymer tubing	3-79, 3-80
MT5000	Altera medical-grade, USP Class VI, flexible, polyolefin tubing	3-81, 3-82
NT	Flexible, general purpose modified elastomeric tubing	3-83, 3-84
NT-MIL	Flexible, rugged, modified elastomeric heat-shrinkable tubing	3-85, 3-86
NTFR	Very flexible, rugged neoprene elastomer tubing	3-87, 3-88
PD Caps	Semirigid, encapsulant-lined, polyolefin caps	3-89, 3-90
RayBlock 85	Heat-shrinkable water-blocking system	3-91, 3-92
RayBlock 105	Heat-shrinkable water-blocking system	3-93, 3-94
Rayflex	PET and PFR expandable, braided, polyester sleeving	3-95, 3-96
Rayflex PETM	Expandable, braided, polyester sleeving	3-97, 3-98
Rayrim	Commercial protective, self-adhering, edging material	3-99, 3-100
RNF-150	High-performance, flame-resistant, flexible, fluoropolymer tubing	3-101, 3-102
RT-375	Clear, flame-resistant, flexible, fluoropolymer tubing	3-103, 3-104
RT555	Fluid-resistant, chemical-resistant, crosslinked fluoropolymer tubing with extended temperature range	3-105, 3-106
RW-175	High temperature, chemical-resistant, polyvinylidene fluoride tubing	3-107, 3-108
SFR	Very flexible, flame-retardant, silicone elastomer tubing	3-109, 3-110
SRFR	Highly flexible, silicone rubber tubing	3-111, 3-112
TFE and TFE-R	High-temperature, chemically inert, modified tubing made of Teflon® Fluoropolymer	3-113, 3-114
Viton®/Viton®-HW/ Viton®-E/ Viton®-TW	Heat-shrinkable, chemical-resistant, high-temperature tubing	3-115, 3-116
XFFR	Halogen-free, flame-retardant, heat-shrinkable tubing	3-117, 3-118
ZH-100	Flexible, thin-wall, low-fire-hazard tubing	3-119, 3-120
ZHTM	Heat-shrinkable, flexible tubing with low toxicity for fire safety applications	3-121, 3-122

TEFLON is a trademark of E.I. du Pont de Nemours and Company

VITON is a trademark of Dupont Dow Elastomers LLC

Tyco Electronics Raychem brand of tubing was developed when our scientists pioneered the application of radiation crosslinking and the development of heat-shrinkable polymer products. Today Tyco Electronics is recognized worldwide for its expertise in these areas.

The Raychem brand of tubings are made of polyolefins, fluoropolymers, and elastomers enhanced by radiation crosslinking and heat-shrinkability. When

Overview

heated during installation, our tubings shrink to conform to virtually any shape. They provide dependable insulation, mechanical protection, and strain relief, as well as aesthetic appeal.

Single wall tubings are available in thin-wall, medium-wall, and thick-wall versions. With dual wall tubings, an inner wall — either an encapsulant or an adhesive — melts and flows during installation heating, to protect against

environmental damage. Encapsulants protect connections and components from splashes and corrosion. Adhesives go a step further, sealing to plastic, metal, rubber, or other substrates.

You can choose from tubings that are highly flexible or semirigid, designed for operation in high- or low-temperature environments, and halogen-free and flame-retardant to meet a range of industry standards.

Available in many sizes, constructions, lengths, and colors to meet both commercial and military specifications, our tubings can also be customized for special applications.

Installation is fast and easy with handheld heating tools or bench-mounted heaters. A range of automatic and semi-automatic installation equipment is available for high-volume applications.

Tubing Categories

Single Wall	Type	Product Name		
	Very Flexible	LSTT Versafit	Versafit V2 Versafit V4	
Flexible	CGPE-105 CGPT DCPT	RNF-100		TUGA
		RNF-3000 RP-4800		
Semirigid	CRN	RT-3		
Dual Wall	Semi-flexible	ATUM	DWP-125	HTAT
	Flexible	RPPM	TAT-125	
	Semirigid	ES1000 ES2000	FL2500 SCL	SCT
Heavy Duty	BSTS HF	HRHF/HRNF/HRSR RMW	RHW SST	
Special Purpose	Elastomers	DR-25 NT NT-MIL NTFR	SFR SRFR Viton® Viton®-HW	Viton®-E Viton®-TW
	Fluoropolymers	RNF-150 RT-375	RT555 RW-175	TFE and TFE-R
	Medical-grade	MT1000 MT2000	MT3000 MT5000	
	MicroFit	MFT-RW-175	MFT-MT1000	MFT-MT2000
	Caps	ES Caps PD Caps		
	Conduit	HCTE		
	Kits	RayBlock 85	RayBlock 105	
	Low toxicity	XFFR	ZH-100	ZHTM
	Edging material	Rayrim		
	Fiber and fabric	HFT5000		
	Braid	RF-PET	RF-PFR	RF-PETM

VITON is a trademark of Dupont Dow Elastomers LLC

PRODUCT			Polyolefin	Fluoropolymer	Elastomer	Operating Temperature °C / [°F]	Min. shrink temperature (°C)	Min. full recovery temperature (°C)	Shrink ratio	
Single Wall	Very flexible	LSTT	•			-40 to 125 [-40 to 257]	65	110	2:1	
		Versafit	•			-55 to 135 [-67 to 275]	70	90	2:1	
		Versafit V2	•			-30 to 125 [-22 to 257]	70	90	2:1	
		Versafit V4	•			-30 to 125 [-22 to 257]	70	90	2:1	
	Flexible	CGPE-105	•			-70 to 105 [-94 to 221]	85	110	2:1	
		CGPT	•			-40 to 135 [-40 to 275]	80	120	2:1	
		DCPT	•			-55 to 135 [-67 to 275]	95	120	2:1	
		RNF-100	•			-55 to 135 [-67 to 275]	95	121	2:1	
		RNF-3000	•			-55 to 135 [-67 to 275]	80	120	3:1	
		RP-4800	•			-55 to 135 [-67 to 275]	95	121	4:1	
		TUGA	•			-55 to 125 [-67 to 257]	85	110	2:1	
		Semirigid	CRN	•			-55 to 135 [-67 to 275]	110	135	2:1
			RT-3	•			-55 to 135 [-67 to 275]	110	135	2.5:1
		Dual wall [adhesive-and encapsulant-lined]	Semiflexible	ATUM	•			-55 to 110 [-67 to 230]	80	110
DWP-125	•					-40 to 110 [-40 to 230]	80	125	3:1	
HTAT	•					-55 to 125 [-67 to 257]	80	110	4:1	
Flexible	RPPM		•			-40 to 85 [-40 to 185]	60	80	4:1	
	TAT-125		•			-55 to 110 [-67 to 230]	95	121	2:1	
Semirigid	ES1000		•			-40 to 130 [-40 to 266]	110	135	4:1	
	ES2000		•			-40 to 130 [-40 to 266]	110	135	4:1	
	FL2500		•			-40 to 135 [-40 to 275]	110	135	4:1	
	SCL		•			-55 to 110 [-67 to 230]	125	135	3:1	
	SCT		•			-40 to 150 [-40 to 302]	110	135	4:1	
Heavy Duty	BSTS		•			-55 to 90 [-67 to 194]	90	121	3:1	
	HF		•			-55 to 90 [-67 to 194]	80	121	3:1	
	HRHF/HRNF/HRSR		•			-55 to 90 [-67 to 194]	80	121	5.6:1	
	RHW		•			-55 to 110 [-67 to 230]	110	125	3:1	
	RMW		•			-55 to 110 [-67 to 230]	110	125	3:1	
	SST	•			-55 to 90 [-67 to 194]	90	121	3:1		
Special Purpose	Elastomers	DR-25		•		-75 to 150 [-103 to 302]	150	175	2:1	
		NT		•		-55 to 90 [-67 to 194]	90	135	2:1	
		NT-MIL		•		-70 to 121 [-94 to 250]	90	135	2:1	
		NTRF		•		-70 to 121 [-94 to 250]	90	135	2:1	
		SFR		•		-75 to 180 [-103 to 356]	135	175	1.75:1	
		SFRF		•		-75 to 200 [-103 to 392]	135	175	1.5:1	
		Viton®		•		-40 to 200 [-40 to 392]	100	175	2:1	
		Viton®-HW		•		-40 to 200 [-40 to 392]	100	175	2:1	
		Viton®-E		•		-55 to 200 [-67 to 392]	100	175	2:1	
		Viton®-TW		•		-40 to 200 [-40 to 392]	100	175	2:1	
Fluoropolymers	RNF-150		•		-55 to 150 [-67 to 302]	110	150	2:1		
	RT-375		•		-55 to 150 [-67 to 302]	125	150	2:1		
	RT555		•		-65 to 200 [-85 to 392]	150	220	2:1		
	RW-175		•		-55 to 175 [-67 to 347]	155	175	2:1		
	TFE and TFE-R		•		-67 to 250 [-89 to 482]	330	340	1.8:1/ 3.2:1		
	Medical-grade	MT1000		•		-55 to 175 [-67 to 347]	155	175	2:1	
		MT2000		•		-40 to 105 [-40 to 221]	110	140	2.5:1	
MT3000			•		-55 to 150 [-67 to 302]	110	150	2:1		
MT5000			•		-70 to 105 [-94 to 221]	90	110	2:1		
MicroFit	MFT-RW-175		•		-55 to 175 [-67 to 347]	155	175	2.5:1		
	MFT-MT1000		•		-55 to 125 [-67 to 257]	155	175	2.5:1		
	MFT-MT2000		•		-40 to 105 [-40 to 221]	110	140	2.5:1		
Caps	ES Caps		•		-40 to 105 [-40 to 221]	100	135	4:1		
	PD Caps		•		-55 to 110 [-67 to 230]	125	135	3:1		
Conduit	HCTE		•		-55 to 200 [-67 to 392]	N/A	N/A	N/A		
	Kits	RayBlock 85		•		-40 to 85 [-40 to 185]	80	110	4:1	
Low Toxicity	RayBlock 105		•		-40 to 105 [-40 to 221]	80	110	4:1		
	XFFR		•		-55 to 105 [-67 to 221]	70	121	3:1		
	ZH-100		•		-30 to 105 [-22 to 221]	80	120	2:1		
Edging Matl	ZHTM		•		-30 to 105 [-22 to 221]	80	121	2:1		
	Rayrim		•		-55 to 80 [-67 to 176]	120	150	N/A		
Fiber & Fabric	HFT5000		•		-40 to 125 [-40 to 257]	80	110	2:1		
	Braids	RF-PET		•		-50 to 150 [-58 to 302]	N/A	N/A	N/A	
		RF-PFR		•		-50 to 150 [-58 to 302]	N/A	N/A	N/A	
		RF-PETM		•		-50 to 150 [-58 to 302]	N/A	N/A	N/A	

*For specific MIL-Spec information for each product, refer to individual product pages or the Tubing Cross-Reference Guide on page 3-6.
 **Sizes 9/3 through 70/21 only. †Clear is not flame-retardant VITON is a trademark of Dupont Dow Elastomers LLC.

Size range (inside diameter as supplied)	Colored	Clear	Flame- retardant	UL 224	CSA	VW-1 (UL/CSA)	MIL Spec*	USP Class VI	ABS	UL D486**	DESCRIPTION
1.6 mm to 38 mm	•	•									Non-flame-retardant polyolefin
3/64" to 4"	•		•	•	•	•	•				Highly flame-retardant, multi-spec polyolefin
1 mm to 30 mm	•		•	•	•	•					Highly flame-retardant polyolefin
3/64" to 1"	•		•	•	•	•					Very-thin-wall, highly flame-retardant polyolefin
1 mm to 10 mm	•		•	•	•	•					
3/64" to 2"	•	•									Brightly colored, general purpose polyolefin
1.6 mm to 38 mm	•	•	•	•	•						General purpose, flame-retardant polyolefin†
3 mm to 38 mm	•		•	•	•	•					Green and yellow striped polyolefin
3/64" to 5"	•	•	•	•	•	•	•				High-performance flexible polyolefin†
1.5 mm to 39 mm	•	•	•	•	•	•	•				3:1 shrink ratio general-purpose polyolefin†
3/4" to 4.5"	•		•	•	•	•	•				4:1 shrink ratio polyolefin
1.2 mm to 38 mm	•	•									Brightly colored, tough polyolefin
3/64" to 3/4"	•	•	•	•	•	•	•				Flame-retardant polyolefin†
.240" to .485"	•		•	•	•	•					Semirigid polyolefin for terminal insulation
3 mm to 40 mm	•	•	•	•	•	•	•				3:1 and 4:1 shrink ratio adhesive-lined polyolefin†
4 mm to 52 mm	•		•	•	•	•					
1/8" to 1"	•		•	•	•	•					3:1 shrink ratio adhesive-lined polyolefin
4 mm to 48 mm	•		•								High-temperature adhesive-lined polyolefin
4 mm to 16 mm	•	•									Dual wall, moisture-proof polyolefin
1/8" to 1 1/2"	•	•	•	•			•				2:1 adhesive-lined polyolefin†
.225" to .700"	•	•		•							Clear high-shrink-ratio adhesive-lined polyolefin
.225" to .700"	•		•	•							Flame-retardant adhesive-lined polyolefin
.300" to .700"	•		•								Fully flame-retardant, adhesive-lined polyolefin
1/8" to 1"	•			•			•				3:1 shrink ratio encapsulant-lined polyolefin
.300" to .700"	•		•								High-temperature adhesive-lined polyolefin
.3" to 4.5"	•		•						•		Rugged, general purpose, thick-wall polyolefin
.4" to 2.7"	•		•						•		Highly flexible, thick-wall polyolefin
.6" to 4"	•		•						•		High-shrink-ratio repair sleeve
9 mm to 180 mm	•									•	Heavy wall adhesive-lined polyolefin
10 mm to 180 mm	•										Medium wall polyolefin
.3" to 4.5"	•		•				•			•	Self-sealing, dual wall polyolefin
1/8" to 3"	•		•				•				Diesel-resistant elastomer
1/8" to 4"	•		•	•	•						Flexible general-purpose modified elastomer
1/8" to 4"	•		•				•				Flexible rugged modified elastomer
1/8" to 3"	•		•				•				Very flexible rugged neoprene
1/4" to 2"	•		•				•				Very flexible silicone
2.9 mm to 51 mm	•		•	•		•					Very flexible silicone rubber
1/8" to 2"	•		•				•				High-temperature flexible elastomer
1/8" to 2"	•		•				•				Heavy-walled Viton® elastomer
1/8" to 2"	•		•				•				High-temperature flexible elastomer
1/8" to 2"	•		•				•				High-temperature flexible elastomer
3/64" to 1"	•		•	•		•	•				High-performance flexible fluoropolymer
3/64" to 1 1/2"	•	•	•	•	•	•	•				Clear high-performance flexible fluoropolymer
1/8" to 2"	•		•	•	•	•	•				Fluid- and chemical-resistant fluoropolymer
3/64" to 1 1/2"	•	•	•	•	•	•	•				High-performance fluoropolymer
0.8 mm to 11.9 mm/ 2 mm to 32 mm		•	•				•				High-temperature Teflon® fluoropolymer resin
1/16" to 1"	•	•						•			Autoclavable semirigid fluoropolymer
1 mm to 10 mm	•	•						•			Lubricious thin-wall polyolefin
1/16" to 1"	•							•			High-temperature flexible fluoropolymer
1/16" to 1"	•	•						•			Flexible polyolefin
.014" to .045"	•	•	•								High performance fluoropolymer microtubing
.014" to .045"	•	•						•			Semirigid medical-grade fluoropolymer microtubing
.014" to .045"	•	•						•			Lubricious medical-grade polyolefin microtubing
.225" to .427"	•	•	•	•							High-ratio, adhesive-lined caps
1/8" to 1/2"	•			•							Semirigid encapsulant-lined polyolefin caps
.187" to 2"	•		•								Modified ETFE, helically convoluted tubing
12 mm to 32 mm	•		•								Heat-shrinkable water blocking system
12 mm to 32 mm	•		•								Heat-shrinkable water blocking system
.4" to 3"	•		•						•		Halogen-free, flame-retardant polyolefin
1/8" to 2"	•		•								Thin-wall, low-fire-hazard polyolefin
3 mm to 40 mm	•		•								Low toxicity, flexible polyolefin
0.8 mm to 4.5 mm	•										Protective self-adhering edging material
12 mm to 80 mm	•										Heat-shrinkable, fabric tubing
1/8" to 2"	•										Expandable, braided polyester sleeving
1/8" to 2"	•		•	•	•	•					Expandable, braided polyester sleeving
3 mm to 50 mm	•										Expandable, braided polyester sleeving

TEFLON is a trademark of E. I. du Pont de Nemours and Company. VITON is a trademark of Dupont Dow Elastomers LLC.

Catalog 1654025
Revised 12-04

Dimensions are in millimeters and inches unless otherwise specified. Values in brackets are U.S. equivalents.

Dimensions are shown for reference purposes only. Specifications subject to change.

USA: 1-800-522-6752
Canada: 1-905-470-4425
Mexico: 01-800-733-8926
C. America: 52-55-5-729-0425

South America: 55-11-3611-1514
Japan: 81-44-900-5102
Singapore: 65-4866-151
UK: 44-1793-528171

www.tycoelectronics.com

Downloaded from Elcodis.com electronic components distributor

Product Type	UL File	CSA File	AMS-DTL-23053*		MIL-PRF-46846		Raychem Specification	Page No.
			Sheet	Class	Type	Class		
ATUM	E85381**		/4	3			RW-2063 & RK-6024	3-33
BSTS							RW-2017	3-53
BSTS-FR			/15	1 & 2***			RW-2017	3-53
CGPE-105							CGPE-105 SCD	3-7
CGPT	E35586	LR31929					RW-2059	3-9
CRN Type 1 (colors)	E35586	LR31929†	/6	1			RT-360, Type 1	3-11
CRN Type 2 (clear)			/6	2			RT-360, Type 2	3-11
DCPT	E35586	LR31929					RW-2056	3-13
DR-25			/16				RT-1116	3-65
DWP-125	E35586	LR31929					DWP-125 SCD	3-35
ES1000	E85381						RT-1113	3-37
ES2000	E85381						RT-1112	3-39
ES Caps	E85381						RW-3006	3-67
FL2500							FL2500 SCD	3-41
HCTE							RT-1162	3-69
HF			/15	1***			RW-2023	3-55
HFT5000	E199379						RW-2060	3-71
HRSR							RW-2013	3-57
HRNF							RW-2013	3-57
HRHF							RW-2013	3-57
HTAT							RW-2052	3-43
LSTT							RW-2051	3-15
MFT-MT1000							Altera MicroFit SCD	3-73
MFT-MT2000							Altera MicroFit SCD	3-73
MFT-RW-175							RW-175 MicroFit SCD	3-73
MT1000***							MT1000 SCD	3-75
MT2000***							MT2000 SCD	3-77
MT3000							MT3000 SCD	3-79
MT5000***							MT5000 SCD	3-81
NT	E35586	LR31929					RT-510	3-83
NT-MIL			/1	1 & 2			RW-3030	3-85
NTRF							RT-511	3-87
PD Caps	E85381						PD Caps SCD	3-89
RayBlock 85							RW-2101	3-91
RayBlock 105							RW-2102	3-93
Rayrim							RK-6182	3-99
RF-PETM								3-97
RF-PET							RW-2069	3-95
RF-PFR								3-95
RHW	E115664						RHW SCD	3-59
RMW							RMW SCD	3-61
RNF-100 Type 1 (colors)	E35586	LR31929	/5	1			RT-350, Type 1	3-17
RNF-100 Type 2 (clear)			/5	2			RT-350, Type 2	3-17
RNF-150	E35586 VW-1		/18	2			RT-370	3-101
RNF-3000	E35586	LR31929					RW-2053	3-19
RPPM							RK-6214	3-45
RP-4800	E35586		/5	1††			RT-1122	3-21
RT-3	E35586	LR31929†					RT-360†††	3-23
RT-375	E35586 VW-1	LR31929 VW-1	/18	2			RT-375	3-103
RT555	E85381						RT-555	3-105
RW-175	E35586 VW-1	LR31929 VW-1	/8				RW-3029	3-107
SCL	E85381		/4	1			RT-1301	3-47
SCT							SCT SCD	3-49
SFR			/10		II	1	RT-1140	3-109
SRFR	E85381 VW-1						RT-1142/RW-2057	3-111
SST							RW-2011	3-63
SST-FR			/15	1 & 2			RW-2011	3-63
TAT-125 Type 1 (colors)	E85381		/4	2			TAT-125 SCD	3-51
TAT-125 Type 2 (clear)							TAT-125 SCD	3-51
TFE/TFE-R							RW-2054, RW-2055	3-113
TUGA-GP							RW-2201	3-25
Versafit	E35586 VW-1	LR31929 VW-1	/5	1 & 3			RW-3009	3-27
Versafit V2	E35586 VW-1	LR31929 VW-1					RW-3023	3-29
Versafit V4	E85381 VW-1	LR31929 VW-1					RW-3023	3-31
Viton®			/13				RT-1146	3-115
Viton®-HW					III	1	RT-1145	3-115
Viton®-E							RK-6014/1	3-115
Viton®-TW							RK-6014/2	3-115
XFFR							RW 2016	3-117
ZH-100							RW-2031	3-119
ZHTM							RW-2058	3-121

*Formerly MIL-I-23053 and MIL-DTL-23053 **Black only, except sizes 3/1 and 4/1. ***Without adhesive

†Black only †† Overexpanded †††With exception to dimensions and longitudinal change.

VITON is a trademark of Dupont Dow Elastomers LLC.

Brightly Colored, Shiny, Non-Flame-Retardant Polyolefin Tubing

Product Facts

- Bright, shiny surface; clear version offers exceptional clarity
- Can be easily hot-stamped
- Economical, yet offers the improved performance of a crosslinked material
- Conforms to substrates more uniformly and with less longitudinal change than most PVC-based materials



Applications

Attractive covering for many automotive, appliance, and consumer-goods applications. Commercial grade tubing for applications where a flame-retardant product is not needed. Provides both insulation and protection of components and wires while also providing a smooth, glossy finish with a choice of five standard colors as well as clear. Exceptional transparency of clear CGPE-105 makes it an ideal choice for protecting marked surfaces.

Installation

Minimum shrink temperature: 85°C [185°F]
 Minimum full recovery temperature: 110°C [230°F] for black; 100°C [212°F] for all other colors and clear

Operating Temperature Range

-70°C to 105°C
 [-94°F to 221°F]

Specifications/Approvals

Series	Raychem
CGPE-105	CGPE-105 SCD

Available in:	Americas	Europe	Asia Pacific
	■		■

Product Dimensions

Single Wall Tubing

CGPE-105 (Continued)

Size	Inside Diameter		Recovered Wall Thickness** After Heating
	Minimum Expanded as Supplied	Maximum Recovered After Heating	
3/64	1.2 [0.046]	0.6 [0.023]	0.40 ± 0.08 [0.016 ± 0.003]
1/16	1.6 [0.063]	0.8 [0.031]	0.43 ± 0.08 [0.017 ± 0.003]
3/32	2.4 [0.093]	1.2 [0.046]	0.51 ± 0.08 [0.020 ± 0.003]
1/8	3.2 [0.125]	1.6 [0.062]	0.51 ± 0.08 [0.020 ± 0.003]
3/16	4.8 [0.187]	2.4 [0.093]	0.51 ± 0.08 [0.020 ± 0.003]
1/4	6.4 [0.250]	3.2 [0.125]	0.64 ± 0.08 [0.025 ± 0.003]
3/8	9.5 [0.375]	4.8 [0.187]	0.64 ± 0.08 [0.025 ± 0.003]
1/2	12.7 [0.500]	6.4 [0.250]	0.64 ± 0.08 [0.025 ± 0.003]
3/4	19.1 [0.750]	9.5 [0.375]	0.76 ± 0.08 [0.030 ± 0.003]
1	25.4 [1.000]	12.7 [0.500]	0.89 ± 0.12 [0.035 ± 0.005]
1 1/2	38.1 [1.500]	19.1 [0.750]	1.02 ± 0.15 [0.040 ± 0.006]
2	50.8 [2.000]	25.4 [1.000]	1.14 ± 0.18 [0.045 ± 0.007]

**Wall thickness will be less if tubing recovery is restricted during shrinkage.

Ordering Information

Color	Standard	Black (-0), white (-9), clear (-X), red (-2), blue (-6), yellow (-4)
	Nonstandard	Green (-5), violet (-7)
Size selection	Always order the largest size that will shrink snugly over the component to be covered. Special order sizes are available upon request.	
Standard packaging	On spools.	
Ordering description	Specify product name, size and color (for example, CGPE-105-1/4-0).	

General Purpose, Flame-Retardant* Polyolefin Tubing

Product Facts

- 2:1 and 3:1 shrink ratio
- Very good chemical and solvent resistance
- Flexible
- Excellent physical and electrical performance



Specifications/Approvals

CGPT

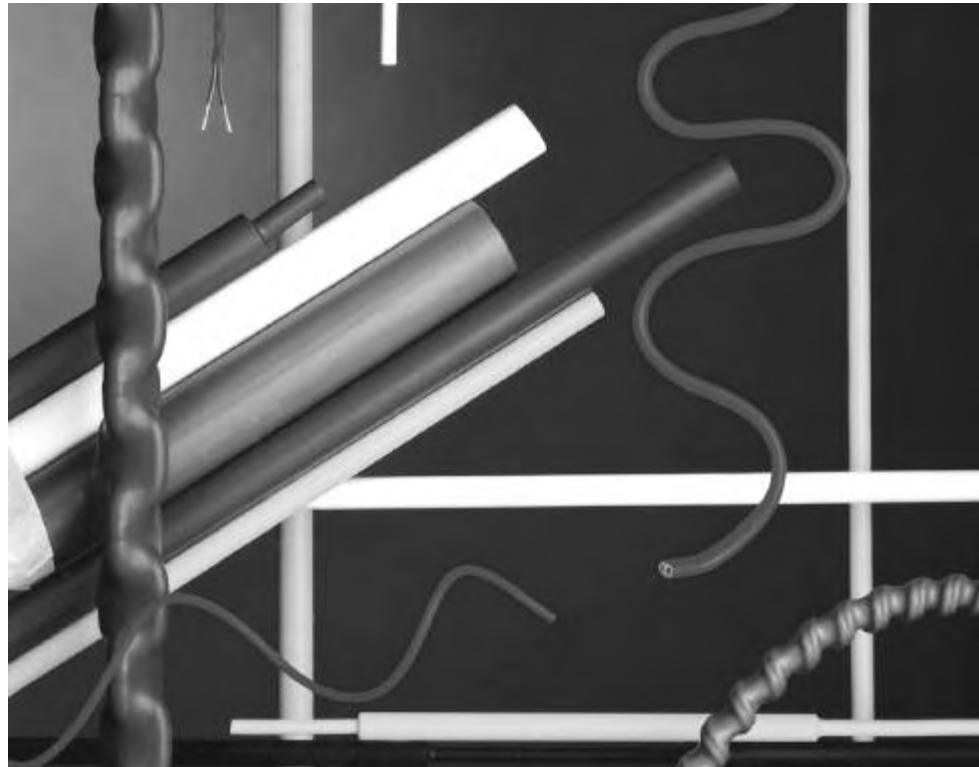

Applications



CGPT is a tough, flexible, general purpose polyolefin tubing with good resistance to common fluids and solvents and a high dielectric strength. Its unique blend of chemical, electrical, and physical properties makes it suitable for a wide range of applications, including electrical insulation, strain relief, cable bundling, color-coding and identification of wires, cables, pipes, and electrical and electronic components, and mechanical protection.

Installation

Minimum shrink temperature: 80°C [176°F]
 Minimum full recovery temperature: 120°C [248°F]

Operating Temperature Range

-40°C to 135°C
 [-40°F to 275°F]

Series	UL 	CSA 	Raychem
CGPT	E35586 600 V, 125°C	LR31929 600 V, 125°C	RW-2059

*Clear product (-X) is not flame-retardant.

Available in:	Americas	Europe	Asia Pacific
		■	

Product Dimensions

CGPT (Continued)

Size	Inside Diameter		Recovered Wall Thickness** After Heating
	Minimum Expanded as Supplied	Maximum Recovered After Heating	
2:1			
1.2/06	1.2 [0.046]	0.6 [0.023]	0.45 ± 0.12 [0.018 ± 0.005]
1.6/0.8	1.6 [0.062]	0.8 [0.031]	0.45 ± 0.12 [0.018 ± 0.005]
2.4/1.2	2.4 [0.093]	1.2 [0.046]	0.50 ± 0.12 [0.019 ± 0.005]
3.2/1.6	3.2 [0.125]	1.6 [0.062]	0.50 ± 0.12 [0.019 ± 0.005]***
4.8/2.4	4.8 [0.187]	2.4 [0.093]	0.50 ± 0.12 [0.019 ± 0.005]***
6.4/3.2	6.4 [0.250]	3.2 [0.125]	0.65 ± 0.15 [0.026 ± 0.006]***
9.5/4.8	9.5 [0.375]	4.8 [0.187]	0.65 ± 0.15 [0.026 ± 0.006]***
12.7/6.4	12.7 [0.500]	6.4 [0.250]	0.65 ± 0.15 [0.026 ± 0.006]***
19/9.5	19.0 [0.748]	9.5 [0.375]	0.75 ± 0.15 [0.029 ± 0.006]***
25.4/12.7	25.4 [1.000]	12.7 [0.500]	0.90 ± 0.20 [0.035 ± 0.008]***
32/16	32.0 [1.250]	16.0 [0.630]	0.95 ± 0.20 [0.037 ± 0.008]***
38/19	38.0 [1.496]	19.0 [0.748]	1.00 ± 0.20 [0.039 ± 0.008]***
51/26	51.0 [2.000]	26.0 [1.000]	1.15 ± 0.25 [0.045 ± 0.010]
76/38	76.0 [2.992]	38.0 [1.496]	1.25 ± 0.25 [0.049 ± 0.010]
102/51	102.0 [4.016]	51.0 [2.008]	1.40 ± 0.30 [0.055 ± 0.012]
3:1			
1.5/0.5	1.5 [0.059]	0.5 [0.020]	0.45 ± 0.12 [0.018 ± 0.005]***
3/1	3.0 [0.118]	1.0 [0.040]	0.55 ± 0.12 [0.022 ± 0.005]***
6/2	6.0 [0.236]	2.0 [0.079]	0.65 ± 0.12 [0.026 ± 0.005]***
9/3	9.0 [0.354]	3.0 [0.118]	0.75 ± 0.15 [0.030 ± 0.006]***
12/4	12.0 [0.472]	4.0 [0.157]	0.75 ± 0.15 [0.030 ± 0.006]***
18/6	18.0 [0.709]	6.0 [0.236]	0.85 ± 0.15 [0.033 ± 0.006]***
24/8	24.0 [0.945]	8.0 [0.315]	1.00 ± 0.20 [0.039 ± 0.008]***
39/13	39.0 [1.540]	13.0 [0.512]	1.15 ± 0.25 [0.045 ± 0.010]

**Wall thickness will be less if tubing recovery is restricted during shrinkage.

Ordering Information

Color	Standard	Black (-0), White (-9), red (-2), blue (-6), yellow (-4), green (-5), clear (-X), yellow/green (-45) as indicated by an ***
Size selection	Always order the largest size that will shrink snugly over the component to be covered. Special order sizes are available upon request.	
Standard packaging****	On spools.	
Ordering description	Specify product name, size and color (for example, CGPT 4.8/2.4-0).	

****Available in the convenient RaySpool packaging/dispensing system for sizes:

- 2:1 - 2.4/1.2 up to 25.4/12.7
- 3:1 - 3/1 up to 24/8

Semirigid,
Flame-Retardant,
Polyolefin Tubing

Product Facts

- 2:1 shrink ratio
- High abrasion resistance
- Transfer of flex stress away from typically weak points such as solder and crimp joints, helping ensure a reliable connection
- Flame-retardance (colors only)
- Outstanding physical and electrical performance
- Excellent chemical and solvent-resistance properties



Applications

Ideally suited for wire strain-relief applications such as soldered or crimped connections, wire splices, and terminations. Provides mechanical protection for delicate components. Can be used for component packaging and for rugged marking of cables.



Installation

Minimum shrink temperature: 110°C [230°F]
Minimum full recovery temperature: 135°C [275°F]

Operating Temperature Range

-55°C to 135°C
[-67°F to 275°F]

Specifications/Approvals

Series	UL 	CSA 	Military	Raychem
CRN Type 1 (colors)	E35586 600 V, 125°C	LR31929 (black only) 600 V, 125°C	AMS-DTL-23053/6*, Class I Def. Stan. 59-97 Type 2C (not red)	RT-360, Type 1 RK-6003
CRN Type 2 (clear)	—	—	AMS-DTL-23053/6*, Class 2	RT-360, Type 2

*Formerly MIL-I-23053/6 and MIL-DTL-23053/6.

Available in:	Americas	Europe	Asia Pacific
	■	■	■

Product Dimensions

Single Wall Tubing

CRN (Continued)

Size	Inside Diameter		Recovered Wall Thickness** After Heating
	Minimum Expanded as Supplied	Maximum Recovered After Heating	
3/64	1.2 [0.046]	0.6 [0.023]	0.51 ± 0.08 [0.020 ± 0.003]
1/16	1.6 [0.063]	0.8 [0.031]	0.51 ± 0.08 [0.020 ± 0.003]
3/32	2.4 [0.093]	1.2 [0.046]	0.51 ± 0.08 [0.020 ± 0.003]
1/8	3.2 [0.125]	1.6 [0.062]	0.51 ± 0.08 [0.020 ± 0.003]
3/16	4.8 [0.187]	2.4 [0.093]	0.64 ± 0.08 [0.025 ± 0.003]
1/4	6.4 [0.250]	3.2 [0.125]	0.64 ± 0.08 [0.025 ± 0.003]
3/8	9.5 [0.375]	4.8 [0.187]	0.76 ± 0.08 [0.030 ± 0.003]
1/2	12.7 [0.500]	6.4 [0.250]	0.76 ± 0.08 [0.030 ± 0.003]
3/4	19.1 [0.750]	9.5 [0.375]	0.89 ± 0.12 [0.035 ± 0.005]

**Wall thickness will be less if tubing recovery is restricted during shrinkage.

Ordering Information

Color	Standard	Black (-0)
	Nonstandard	Clear (-X, not flame-retardant)
Size selection	Always order the largest size that will shrink snugly over the component to be covered. Special order sizes are available upon request.	
Standard packaging	In 1.2-meter [4-foot] lengths.	
Ordering description***	Specify product name, size and color (for example, CRN 1/4-0).	

***Europe only. For supply to MIL, Def Stan and BS add -MS, -DS or -BS to ordering description.

Flexible, Flame-Retardant, Dual-Color, Polyolefin Tubing

Product Facts

- 2:1 and 3:1 shrink ratio
- Dual colors (yellow/green) for instant identification
- Co-extrusion of tubing colors, giving color permanence superior to that of conventional ink marking
- Flame-retardance
- Flexibility: able to conform to irregular shapes
- Excellent physical, chemical, and electrical properties that meet industry standards for highly reliable, general purpose tubing



DCPT

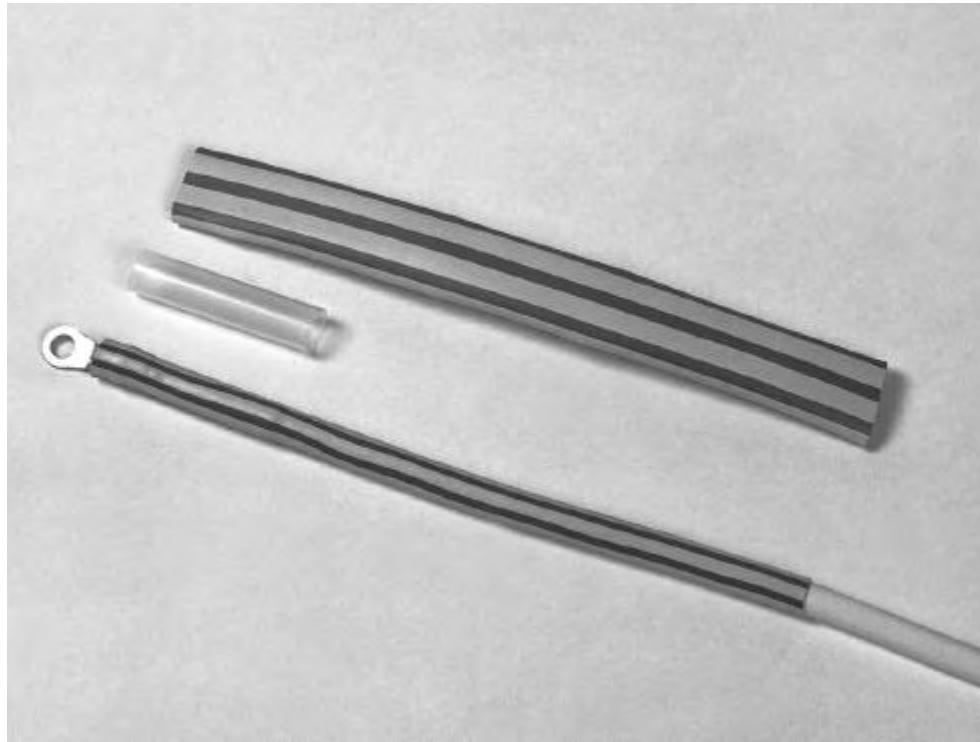

Applications

Used to identify "ground" on wires and in cables, and to jacket and insulate light-duty harnesses.

Easily marked by conventional techniques for additional identification of wires and cables.



Installation

Minimum shrink temperature: 95°C [203°F]
Minimum full recovery temperature: 120°C [248°F]

Operating Temperature Range

-55°C to 135°C
[-67°F to 275°F]

Specifications/Approvals

Series	UL 	CSA 	Military	Agency	Raychem
DCPT	E35586 600 V, 125°C	LR31929 600 V, 125°C	Def Stan 59-97 Issue 3 Type 2B VG 95343 Pt 5 Type A	AFS 2270 DIN 29807 VDE 0341 Pt 9005 Type A	RW-2056

Available in:	Americas	Europe	Asia Pacific
	■	■	■

Product Dimensions

Single Wall Tubing

DCPT (Continued)

Size	Inside Diameter		Recovered Wall Thickness* After Heating
	Minimum Expanded as Supplied	Maximum Recovered After Heating	
2:1			
3/1.5	3 [0.118]	1.5 [0.059]	0.51 ± 0.10 [0.020 ± 0.004]
6/3	6 [0.236]	3.0 [0.118]	0.58 ± 0.10 [0.023 ± 0.004]
8/4	8 [0.315]	4.0 [0.158]	0.64 ± 0.10 [0.025 ± 0.004]
10/5	10 [0.394]	5.0 [0.197]	0.64 ± 0.10 [0.025 ± 0.004]
12/6	12 [0.472]	6.0 [0.236]	0.64 ± 0.10 [0.025 ± 0.004]
19/9	19 [0.748]	9.0 [0.354]	0.76 ± 0.12 [0.030 ± 0.005]
26/13	26 [1.024]	13.0 [0.512]	0.89 ± 0.12 [0.035 ± 0.005]
38/19	38 [1.500]	19.0 [0.748]	1.00 ± 0.12 [0.039 ± 0.005]
51/19	51 [2.000]	19.0 [0.748]	1.02 ± 0.15 [0.040 ± 0.006]
3:1 (Europe only)			
3/1	3.0 [0.118]	1.0 [0.039]	0.55 ± 0.10 [0.022 ± 0.004]
6/2	6.0 [0.236]	2.0 [0.079]	0.65 ± 0.10 [0.026 ± 0.004]
9/3	9.0 [0.354]	3.0 [0.118]	0.75 ± 0.15 [0.030 ± 0.006]
12/4	12.0 [0.472]	4.0 [0.157]	0.75 ± 0.15 [0.030 ± 0.006]
18/6	18.0 [0.709]	6.0 [0.236]	0.85 ± 0.15 [0.033 ± 0.006]
24/8	24.0 [0.945]	8.0 [0.315]	1.00 ± 0.20 [0.039 ± 0.008]

*Wall thickness will be less if tubing recovery is restricted during shrinkage.

Ordering Information

Color	Standard Yellow/green stripe (-45)
Size selection	Always order the largest size that will shrink snugly over the component to be covered. Special order sizes are available upon request.
Standard packaging	On spools.
Ordering description**	Specify product name, size and color (for example, DCPT 8/4-45).

**Europe only. For supply to Def Stan and BS add -DS or -BS to ordering description.

Low-Shrink-Temperature,
Non-Flame-Retardant,
Heat-Shrinkable, Polyolefin
tubing

Product Facts

- 2:1 shrink ratio
- Rapid recovery at low temperatures
- Can be used with temperature-sensitive materials
- Flexible
- Not flame-retardant
- Excellent physical and electrical performance

LSTT



Applications

LSTT is a highly flexible, low-shrink-temperature, heat-shrinkable tubing. Its low shrink temperature offers exceptionally fast recovery for maximum efficiency in high-volume commercial applications and makes it suitable for use on or near delicate, temperature-sensitive materials, such as PVC jacketed wire and cable. Although not flame-retardant, LSTT meets the automotive flame propagation standard MVSS 302.

Typical applications include electrical termination insulation, color-coding, covering of heat-sensitive devices, cosmetic coverings, and mechanical protection.

Installation

Minimum shrink temperature: 65°C [149°F]
Minimum full recovery temperature: 110°C [230°F]

Operating Temperature Range

-40°C to 125°C
[-40°F to 257°F]

Specifications/Approvals

Series	Industry	Raychem
LSTT	MVSS302	RW-2051
Available in:	Americas	Europe
		Asia Pacific

Product Dimensions

LSTT (Continued)

Size	Inside Diameter		Recovered Wall Thickness* After Heating
	Minimum Expanded as Supplied	Maximum Recovered After Heating	
1.6	1.6 [0.063]	0.8 [0.031]	0.50 ± 0.12 [0.018 ± 0.005]
2.4	2.4 [0.093]	1.2 [0.046]	0.55 ± 0.12 [0.022 ± 0.005]
3.2	3.2 [0.125]	1.6 [0.062]	0.55 ± 0.12 [0.022 ± 0.005]
4.8	4.8 [0.187]	2.4 [0.093]	0.55 ± 0.12 [0.022 ± 0.005]
6.4	6.4 [0.250]	3.2 [0.125]	0.65 ± 0.15 [0.026 ± 0.006]
9.5	9.5 [0.375]	4.8 [0.187]	0.65 ± 0.15 [0.026 ± 0.006]
12.7	12.7 [0.500]	6.4 [0.250]	0.65 ± 0.15 [0.026 ± 0.006]
19.0	19.0 [0.748]	9.5 [0.375]	0.80 ± 0.15 [0.032 ± 0.006]
25.4	25.4 [1.000]	12.7 [0.500]	0.95 ± 0.18 [0.037 ± 0.007]
32.0	32.0 [1.260]	16.0 [0.630]	1.05 ± 0.20 [0.041 ± 0.008]
38.0	38.0 [1.496]	19.0 [0.748]	1.05 ± 0.20 [0.041 ± 0.008]
52.0**	52.0 [2.047]	26.0 [1.024]	1.14 ± 0.18 [0.045 ± 0.007]

*Wall thickness will be less if tubing recovery is restricted during shrinkage.

**Available in black only.

Ordering Information

Color	Standard	Black (-0), white (-9), red (-2), blue (-6), yellow (-4)
	Nonstandard	Green (-5), grey (-8), clear (-X)
Size selection	Always order the largest size that will shrink snugly over the component to be covered. Special order sizes are available upon request.	
Standard packaging	On plastic spools***	
Ordering description	Specify product name, size and color (for example, LSTT 6.4-0).	

***Available in the convenient RaySpool packaging/dispensing system, for sizes 2.4 up to 25.4

Flexible, Flame-Retardant,
General Purpose,
Polyolefin Tubing

Product Facts

- 2:1 shrink ratio
- Superior abrasion and solvent resistance when compared with that of many flexible, general purpose polyolefin tubings
- Excellent physical, chemical, and electrical properties that meet or exceed industrial and military standards for highly reliable, general purpose tubing
- Flexible; conforms to irregular shapes
- Flame-retardant (colors only)
- Wide range of sizes and colors



RNF-100

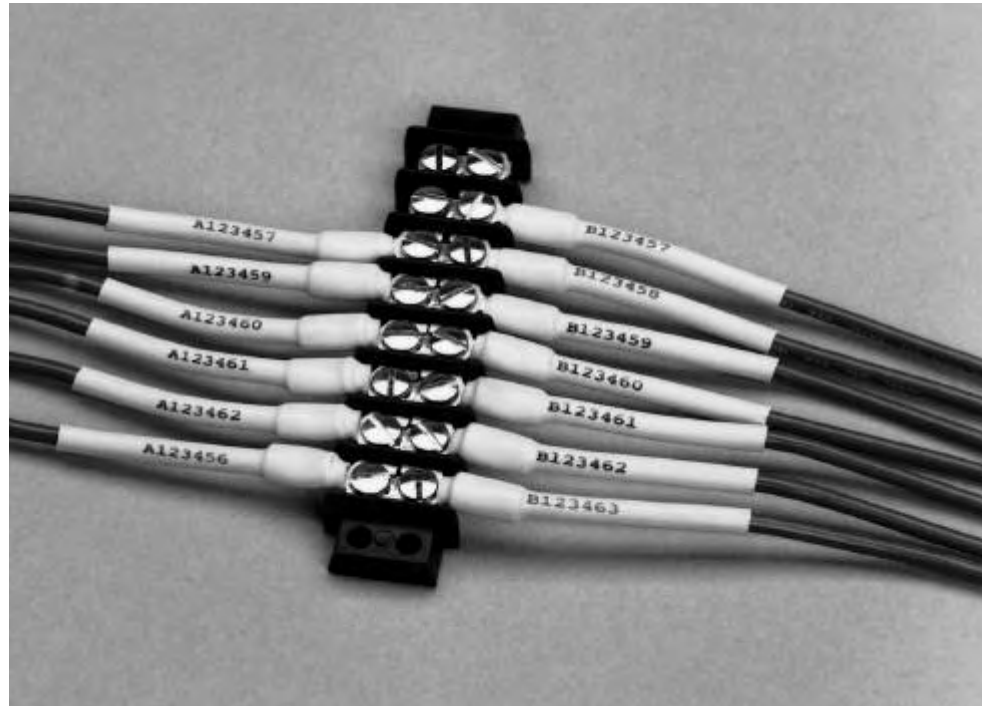

Applications

Designed to provide superior mechanical (abrasion, cut-through, and strain relief), thermal, and fluid-resistance performance in demanding environments. Widely used to provide insulation and strain relief of wire terminations and connections. Used for jacketing wire bundles and light-duty harnesses where superior abrasion resistance is a plus. Also used to identify and color-code electrical connections and wire bundles.



Installation

Minimum shrink temperature: 95°C [203°F]
Minimum full recovery temperature: 121°C [250°F]

Operating Temperature Range

-55°C to 135°C
[-67°F to 275°F]

Specifications/Approvals

Series	UL 	CSA 	Military	Industry	Raychem
RNF-100 Type 1 (colors)	E35586 600 V, 125°C	LR31929 600 V, 125°C	AMS-DTL-23053/5*, Class 1 Def. Stan. 59-97 Type 2B	VDE 0341 Pt 9005 Type A and B	RT-350, Type 1 RK-6001
RNF-100 Type 2 (clear)	—	—	AMS-DTL-23053/5*, Class 2 VG 95343 Pt 5 Type B	—	RT-350, Type 2 RK-6001

*Formerly MIL-I-23053/5 and MIL-DTL-23053/5.

Available in:	Americas	Europe	Asia Pacific
	■	■	■

Product Dimensions

Single Wall Tubing

RNF-100 (Continued)

Size	Inside Diameter		Recovered Wall Thickness** After Heating
	Minimum Expanded as Supplied	Maximum Recovered After Heating	
3/64	1.2 [0.046]	0.6 [0.023]	0.40 ± 0.08 [0.016 ± 0.003]
1/16	1.6 [0.063]	0.8 [0.031]	0.43 ± 0.08 [0.017 ± 0.003]
3/32	2.4 [0.093]	1.2 [0.046]	0.51 ± 0.08 [0.020 ± 0.003]
1/8	3.2 [0.125]	1.6 [0.062]	0.51 ± 0.08 [0.020 ± 0.003]
3/16	4.8 [0.187]	2.4 [0.093]	0.51 ± 0.08 [0.020 ± 0.003]
1/4	6.4 [0.250]	3.2 [0.125]	0.64 ± 0.08 [0.025 ± 0.003]
3/8	9.5 [0.375]	4.8 [0.187]	0.64 ± 0.08 [0.025 ± 0.003]
1/2	12.7 [0.500]	6.4 [0.250]	0.64 ± 0.08 [0.025 ± 0.003]
3/4	19.1 [0.750]	9.5 [0.375]	0.76 ± 0.08 [0.030 ± 0.003]
1	25.4 [1.000]	12.7 [0.500]	0.89 ± 0.12 [0.035 ± 0.005]
1 1/4	31.8 [1.250]	15.9 [0.625]	1.02 ± 0.15 [0.040 ± 0.006]
1 1/2	38.1 [1.500]	19.1 [0.750]	1.02 ± 0.15 [0.040 ± 0.006]
2	50.8 [2.000]	25.4 [1.000]	1.14 ± 0.16 [0.045 ± 0.007]
3	76.2 [3.000]	38.1 [1.500]	1.27 ± 0.20 [0.050 ± 0.008]
4	101.6 [4.000]	50.8 [2.000]	1.40 ± 0.23 [0.055 ± 0.009]
5	127.0 [5.000]	63.5 [2.500]	1.52 ± 0.23 [0.060 ± 0.009]

**Wall thickness will be less if tubing recovery is restricted during shrinkage.

Ordering Information

Color	Standard	Black (-0, BK), white (-9, WH), red (-2, RD), blue (-6, BU), yellow (-4, YO), green (-5, GN), clear (-X, CL)
	Nonstandard	Brown (-1, BN), orange (-3, OR), violet (-7, VT), gray (-8, GY)
Size selection	Always order the largest size that will shrink snugly over the component to be covered. Special order sizes are available upon request	
Standard packaging	On spools or in 1.2-meter [4-foot] lengths.	
Ordering description***	Specify product name, size and color (for example, RNF-100 1/4-0 [Europe] or RNF-100 1/4-BK [Americas]).	

***Europe only. For supply to MIL, Def Stan and BS add -MS, -DS or -BS to ordering description.

Flexible, High-Shrink-Ratio, Flame-Retardant, General Purpose, Polyolefin Tubing

Product Facts

- 3:1 shrink ratio easily accommodates awkward, irregular shapes
- Few sizes cover a wide range of diameters, allowing reduced inventory
- Excellent physical, chemical, and electrical properties meet industry standards for highly reliable, general purpose tubing
- Flame-retardant (colors only)



RNF-3000



3 Heat-Shrinkable Tubing

Applications

Used for insulation and strain relief of wire terminations and electrical connections. Also ideal for light-duty harnessing, jacketing, and identification of wires, cables, and electrical and electronic components.



Installation

Minimum shrink temperature: 80°C [176°F]
Minimum full recovery temperature: 120°C [248°F]

Operating Temperature Range

-55°C to 135°C
[-67°F to 275°F]

Specifications/Approvals

Series	UL 	CSA 	Military	Industry	Raychem
RNF-3000	E35586 600 V, 125°C	LR31929 600 V, 125°C	Def. Stan. 59-97 Type 2B VG 95343 Pt 5 Type A (color) VG 95343 Pt 5 Type B (clear)	VDE 0341 Pt 9005 Type A and B	RW-2053

Available in:	Americas	Europe	Asia Pacific
	■	■	■

Product Dimensions

RNF-3000 (Continued)

Size	Inside Diameter		Recovered Wall Thickness** After Heating
	Minimum Expanded as Supplied	Maximum Recovered After Heating	
1.5/0.5	1.5 [0.060]	0.5 [0.019]	0.45 ± 0.10 [0.018 ± 0.003]
3/1	3 [0.118]	1 [0.039]	0.55 ± 0.10 [0.022 ± 0.003]
4.5/1.5	4.5 [0.177]	1.5 [0.059]	0.55 ± 0.10 [0.022 ± 0.003]
6/2	6 [0.236]	2 [0.079]	0.65 ± 0.10 [0.026 ± 0.003]
9/3	9 [0.354]	3 [0.118]	0.75 ± 0.12 [0.030 ± 0.004]
12/4	12 [0.472]	4 [0.157]	0.75 ± 0.12 [0.030 ± 0.004]
18/6	18 [0.709]	6 [0.236]	0.85 ± 0.12 [0.033 ± 0.004]
24/8	24 [0.944]	8 [0.315]	1.00 ± 0.18 [0.039 ± 0.007]
39/13	39 [1.534]	13 [0.512]	1.15 ± 0.20 [0.045 ± 0.008]

*Wall thickness will be less if tubing recovery is restricted during shrinkage.

Ordering Information

Color	Standard**	Black (-0), white (-9), red (-2), blue (-6), yellow (-4), green (-5), clear (-X)
	Nonstandard	Brown (-1), orange (-3), violet (-7), gray (-8)
Size selection	Always order the largest size that will shrink snugly over the component to be covered. Special order sizes are available upon request.	
Standard packaging***	On spools or in 1.2-meter [4-foot] lengths.	
Ordering description****	Specify product name, size and color (for example, RNF-3000 6/2-0).	

**Black is the only standard color in the Americas. All other colors are nonstandard.

***Only spools are standard in the Americas. 1.2 meter [4-foot] lengths are nonstandard.

****Europe only. For supply to MIL, Def Stan and BS add -MS, -DS or -BS to ordering description.

High-Shrink-Ratio,
Flame-Retardant,
Polyolefin Tubing

Product Facts

- 4:1 shrink ratio
- Conforms well to highly variable substrate dimensions
- Has excellent physical, chemical, and electrical properties that meet or exceed industrial and military standards
- Shows no significant degradation when exposed to common solvents and chemicals, including aviation fuel and hydraulic fluid



RP-4800



3 Heat-Shrinkable Tubing

Applications

Ideal for repairing harnesses or cables; will pass over a large-diameter connector or transition, and then shrink down onto a smaller-diameter jacket. Can insulate or protect a substrate of varying dimensions. Also provides the abrasion and fluid resistance required in harnessing applications.

Installation

Minimum shrink temperature: 95°C [203°F]
Minimum full recovery temperature: 121°C [250°F]

Operating Temperature Range

-55°C to 135°C
[-67°F to 275°F]

Specifications/Approvals

Series	UL	Military	Industry	Raychem
RP-4800	E35586 600V, 125°C (black only)	AMS-DTL-23053/5*, Class 1 Overexpanded VG 95343 Pt 5 Type A	VDE 0341 Pt 9005 Type A	RT-1122

*Formerly MIL-I-23053/5 and MIL-DTL-23053/5.

Available in:	Americas	Europe	Asia Pacific
	■	■	■

Product Dimensions

Single Wall Tubing

RP-4800 (Continued)

Size	Inside Diameter		Recovered Wall Thickness** After Heating
	Minimum Expanded as Supplied	Maximum Recovered After Heating	
No. 1	25.4 [1.000]	7.0 [0.275]	1.14 ± 0.18 [0.045 ± 0.007]
No. 2	50.8 [2.000]	14.0 [0.550]	1.14 ± 0.18 [0.045 ± 0.007]
No. 3	76.2 [3.000]	20.6 [0.810]	1.14 ± 0.18 [0.045 ± 0.007]
No. 4	101.6 [4.000]	26.7 [1.050]	1.14 ± 0.18 [0.045 ± 0.007]
No. 5	25.4 [1.000]	11.7 [0.462]	1.14 ± 0.18 [0.045 ± 0.007]
No. 6	60.3 [2.375]	17.3 [0.680]	1.14 ± 0.18 [0.045 ± 0.007]
No. 7	76.2 [3.000]	21.3 [0.840]	1.14 ± 0.18 [0.045 ± 0.007]
No. 8	95.3 [3.750]	23.6 [0.930]	1.14 ± 0.18 [0.045 ± 0.007]
No. 9	114.3 [4.500]	36.8 [1.450]	1.14 ± 0.18 [0.045 ± 0.007]
No. 10	38.1 [1.500]	9.5 [0.375]	1.14 ± 0.18 [0.045 ± 0.007]
No. 11	19.1 [0.750]	4.6 [0.180]	1.14 ± 0.18 [0.045 ± 0.007]

**Wall thickness will be less if tubing recovery is restricted during shrinkage.

Ordering Information

Color	Standard	Black (-0)
	Nonstandard	White (-9), red (-2), blue (-6), yellow (-4), green (-5), brown (-1), orange (-3), violet (-7), gray (-8)
Size selection	Always order the largest size that will shrink snugly over the component to be covered. Special order sizes are available upon request.	
Standard packaging	On spools or in 1.2-meter [4-foot] lengths.	
Ordering description***	Specify product name, size and color (for example, RP-4800 NO.1-0).	

***Europe only. For supply to MIL, Def Stan and BS add -MS, -DS or -BS to ordering description.

Semirigid, Flame-Retardant, Polyolefin Tubing

Product Facts

- 2.5:1 shrink ratio
- Tightly controlled expanded diameters
- High abrasion resistance
- Semirigidity that transfers flex stress away from typically weak points such as solder and crimp joints, helping to ensure a reliable connection
- Excellent chemical and solvent resistance
- Outstanding physical and electrical performance



RT-3

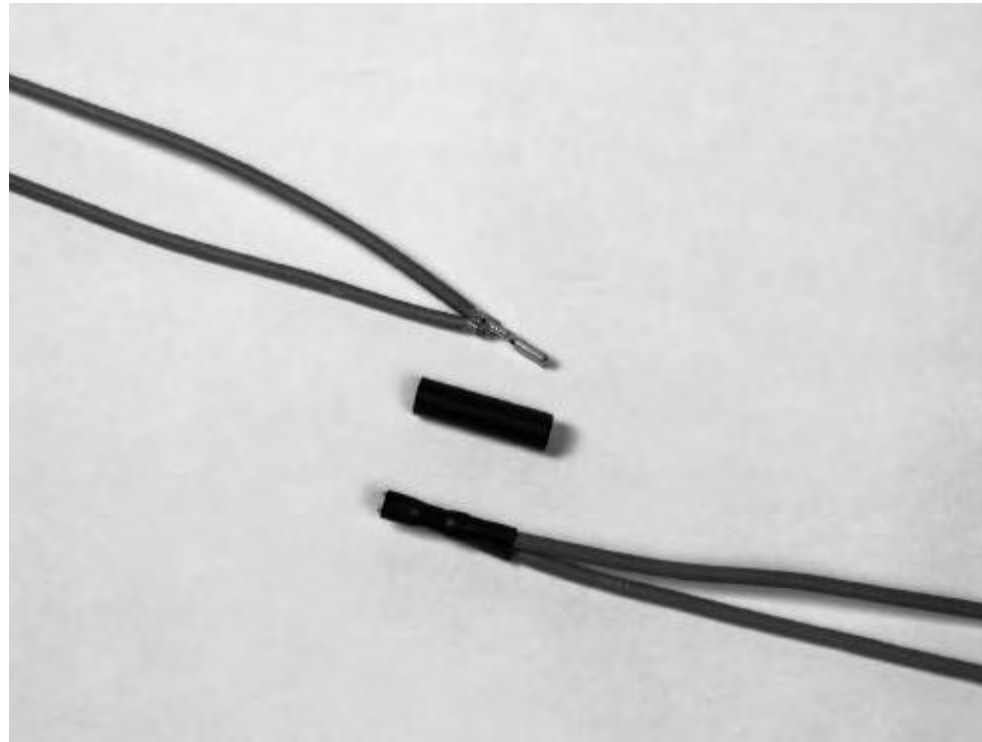

3 Heat-Shrinkable Tubing

Applications

Suitable for wire strain-relief applications — soldered or crimped connections, wire splices, terminations. Well suited for use with semiautomated production equipment requiring tubing with a tightly controlled expanded diameter. Acts as a tough covering for delicate components; provides mechanical protection.



Installation

Minimum shrink temperature: 110°C [230°F]
 Minimum full recovery temperature: 135°C [275°F]

Operating Temperature Range

-55°C to 135°C
 [-67°F to 275°F]

Specifications/Approvals

Series	UL 	CSA 	Raychem
RT-3	E35586 600 V, 125°C	LR31929 (black only) 600 V, 125°C	RT-360*

*Except dimensions and longitudinal change.

Available in:	Americas	Europe	Asia Pacific
	■		■

Product Dimensions

Single Wall Tubing

RT-3 (Continued)

Size	Inside Diameter		Recovered Wall Thickness** After Heating
	Minimum Expanded as Supplied	Maximum Recovered After Heating	
No. 1	6.1 ± 0.4 [0.240 ± 0.015]	2.4 [0.095]	0.79 ± 0.08 [0.031 ± 0.003]
No. 2	8.1 ± 0.4 [0.320 ± 0.015]	3.2 [0.125]	0.79 ± 0.08 [0.031 ± 0.003]
No. 3	9.5 ± 0.5 [0.375 ± 0.020]	3.8 [0.150]	0.79 ± 0.08 [0.031 ± 0.003]
No. 4	12.3 ± 0.5 [0.485 ± 0.020]	5.1 [0.200]	0.79 ± 0.08 [0.031 ± 0.003]

**Wall thickness will be less if tubing recovery is restricted during shrinkage.

Ordering Information

Color	Black only
Size selection	Always order the largest size that will shrink snugly over the component to be covered. Special order sizes are available upon request.
Standard packaging	In 1-inch cut pieces or in 1.2-meter [4-foot] lengths.
Ordering description	Specify product name, size and color (for example, RT-3 No. 1-0).

Brightly Colored, Shiny, Non-Flame-Retardant, Polyolefin Tubing

Product Facts

- 2:1 Shrink ratio
- Can be easily hot-stamped
- Bright, shiny surface; clear version offers exceptional clarity
- Semiflexible, non-flame-retardant, halogen free
- Conforms to substrates more uniformly and with less longitudinal change than most PVC-based materials



TUGA-GP



3 Heat-Shrinkable Tubing

Applications

TUGA-GP is a commercial grade tubing for general applications where a flame-retardant product is not needed but where electrical insulation and mechanical performance are important. TUGA-GP makes an attractive covering for many automotive, appliance, and consumer-goods applications. Exceptional transparency of clear vision makes it an ideal choice for protecting marked surfaces.

Installation

Minimum shrink temperature: 85°C [85°F]
 Minimum full recovery temperature: 110°C [230°F] for black; 100°C [212°F] for all other colors and clear.

Operating Temperature Range

-55°C to 125°C
 [-67°F to 257°F]

Specifications/Approvals

Series	Raychem
TUGA-GP	RW-2201

Available in:	Americas	Europe	Asia Pacific
		■	

Product Dimensions

Single Wall Tubing

TUGA-GP (Continued)

Size	Inside Diameter		Recovered Wall Thickness* Nominal After Heating
	Minimum Expanded as Supplied	Maximum Recovered After Heating	
1.2/0.6	1.2 [0.046]	0.6 [0.023]	0.4 [0.016]
1.6/0.8	1.6 [0.062]	0.8 [0.031]	0.4 [0.016]
2.4/1.2	2.4 [0.093]	1.2 [0.046]	0.5 [0.019]
3/1.5	3.0 [0.118]	1.5 [0.059]	0.5 [0.019]
5/2.5	5.0 [0.197]	2.5 [0.098]	0.5 [0.019]
6.4/32	6.4 [0.250]	3.2 [0.125]	0.6 [0.024]
8/4	8.0 [0.315]	4.0 [0.157]	0.6 [0.024]
9.5/4.8	9.5 [0.375]	4.8 [0.187]	0.6 [0.024]
11/5.5	11.0 [0.433]	5.5 [0.217]	0.6 [0.024]
12.7/6.4	12.7 [0.500]	6.4 [0.250]	0.6 [0.024]
15/7.5	15.0 [0.591]	7.5 [0.295]	0.8 [0.031]
20/10	20.0 [0.787]	10.0 [0.394]	0.8 [0.031]
25.4/12.7	25.4 [1.000]	12.7 [0.500]	0.9 [0.035]
38/19	38.0 [1.496]	19.0 [0.748]	1.0 [0.039]

*Wall thickness will be less if tubing recovery is restricted during shrinkage.

Ordering Information

Color	Standard	Black (-0), white (-9), red (-2)
	Nonstandard	Yellow (-4), clear (-X)
Size selection	Always order the largest size that will shrink snugly over the component to be covered. Special order sizes available upon request.	
Standard packaging	On spools.	
Ordering description	Specify product name, size and color (for example, TUGA 3/1.5-0).	

Highly Flame-Retardant,
Very Flexible, Low-Shrink-
Temperature, Polyolefin
Tubing

Product Facts

- 2:1 shrink ratio
- Low shrink temperature reduces installation time and the risk of damage to temperature-sensitive components
- Very flexible; doesn't easily wrinkle when bent
- Highly flame-retardant
- Hot stamps extremely well
- Higher temperature rating, better thermal stability, and higher resistance to physical abuse than noncrosslinked materials
- Free of polybrominated biphenyls (PBBs) and polybrominated biphenyl oxides and ethers (PBBOs and PBBEs), which are classified as environmentally hazardous substances



Specifications/Approvals

Versafit



Applications



Cost-effective choice for many commercial and military applications; electrically insulates and protects in-line components, disconnect terminals, and splices. Bundles wires for very flexible light-duty harnesses. Strain-relieves electrical wire connections for commercial applications. Identifies or color-codes wires, cables, terminals, and components.

Installation

Minimum shrink temperature: 70°C [158°F]
Minimum full recovery temperature: 90°C [194°F]

Operating Temperature Range

-55°C to 135°C
[-67°F to 275°F]

Series	UL 	CSA 	Military	Raychem
Versafit	E35586 VW-1 600 V, 125°C	LR31929 VW-1 600 V, 125°C	AMS-DTL-23053/5* Classes 1 & 3	RW-3009

*Formerly MIL-I-23053/5 and MIL-DTL-23053/5.

Available in:	Americas	Europe	Asia Pacific
	■	■	■

Product Dimensions

Single Wall Tubing

Versafit (Continued)

Size	Inside Diameter		Recovered Wall Thickness** After Heating
	Minimum Expanded as Supplied	Maximum Recovered After Heating	
3/64	1.63 ± 0.2 [0.064 ± 0.008]	0.6 [0.023]	0.40 ± 0.08 [0.016 ± 0.003]
1/16	1.85 ± 0.2 [0.073 ± 0.008]	0.8 [0.031]	0.43 ± 0.08 [0.017 ± 0.003]
3/32	2.79 ± 0.2 [0.110 ± 0.008]	1.2 [0.046]	0.51 ± 0.08 [0.020 ± 0.003]
1/8	3.43 ± 0.2 [0.135 ± 0.008]	1.6 [0.062]	0.51 ± 0.08 [0.020 ± 0.003]
3/16	5.21 ± 0.3 [0.205 ± 0.010]	2.4 [0.093]	0.51 ± 0.08 [0.020 ± 0.003]
1/4	7.11 ± 0.3 [0.280 ± 0.010]	3.2 [0.125]	0.64 ± 0.08 [0.025 ± 0.003]
3/8	10.16 ± 0.4 [0.400 ± 0.015]	4.8 [0.187]	0.64 ± 0.08 [0.025 ± 0.003]
1/2	13.72 ± 0.4 [0.540 ± 0.015]	6.4 [0.250]	0.64 ± 0.08 [0.025 ± 0.003]
5/8***	16.90 ± 0.4 [0.665 ± 0.015]	8.0 [0.315]	0.76 ± 0.08 [0.030 ± 0.003]
3/4	20.45 ± 0.4 [0.805 ± 0.015]	9.5 [0.375]	0.76 ± 0.08 [0.030 ± 0.003]
1	25.53 ± 0.4 [1.055 ± 0.015]	12.7 [0.500]	0.89 ± 0.12 [0.035 ± 0.005]
1 1/4***	33.40 ± 0.7 [1.315 ± 0.025]	15.9 [0.625]	1.02 ± 0.15 [0.040 ± 0.006]
1 1/2	39.88 ± 0.8 [1.570 ± 0.030]	19.1 [0.750]	1.02 ± 0.15 [0.040 ± 0.006]
2	52.83 ± 1.0 [2.080 ± 0.040]	25.4 [1.000]	1.14 ± 0.16 [0.045 ± 0.007]
3	78.49 ± 1.0 [3.090 ± 0.040]	38.1 [1.500]	1.27 ± 0.20 [0.050 ± 0.008]
4	104.14 ± 1.3 [4.100 ± 0.050]	50.8 [2.000]	1.40 ± 0.23 [0.055 ± 0.009]

**Wall thickness will be less if tubing recovery is restricted during shrinkage.

***Nonstandard size; available by special order only.

Ordering Information

Color	Standard	Black (-0), white (-9), red (-2), blue (-6), yellow (-4), green (-5)
	Nonstandard	Brown (-1), orange (-3), violet (-7), gray (-8)
Size selection	Always order the largest size that will shrink snugly over the component to be covered. Special order sizes are available upon request.	
Standard packaging****	On spools.	
Ordering description*****	Specify product name, size and color (for example, Versafit 1/4-0).	

****Available in the convenient RaySpool packaging/dispensing system, for sizes 1/16" up to 1".

*****Europe only. For supply to MIL, Def Stan and BS add -MS, -DS or -BS to ordering description.

Highly Flame-Retardant, Very Flexible, Low-Shrink-Temperature, Polyolefin Tubing

Product Facts

- 2:1 shrink ratio
- Low shrink temperature reduces installation time and the risk of damage to temperature-sensitive components
- Very flexible; doesn't easily wrinkle when bent
- Highly flame-retardant
- Hot stamps extremely well
- Higher temperature rating, better thermal stability, and higher resistance to physical abuse than noncrosslinked materials
- Free of polybrominated biphenyls (PBBs) and polybrominated biphenyl oxides and ethers (PBBOs and PBBEs), which are classified as environmentally hazardous substances



Versafit V2

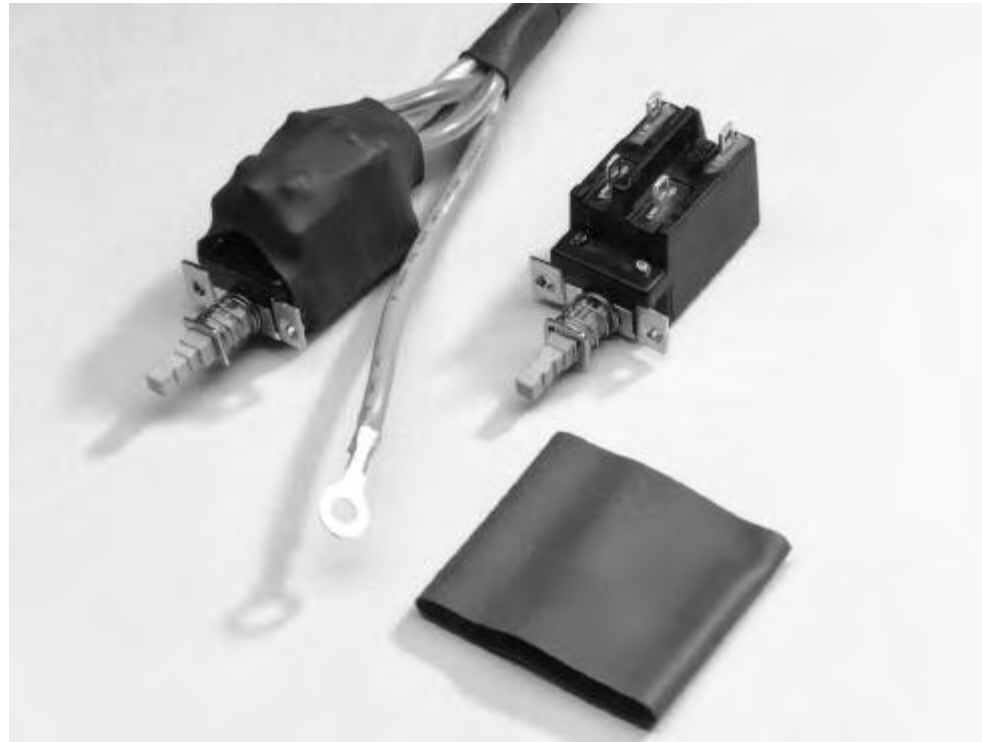

Applications

Cost-effective choice for many commercial applications; electrically insulates and protects in-line components, disconnect terminals, and splices. Bundles wires for very flexible light-duty harnesses. Strain-relieves electrical wire connections. Identifies or color-codes wires, cables, terminals, and components.



Installation

Minimum shrink temperature: 70°C [158°F]
 Minimum full recovery temperature: 90°C [194°F]

Operating Temperature Range

-30°C to 125°C
 [-22°F to 257°F]

Specifications/Approvals

Series	UL 	CSA 	Raychem
Versafit V2	E35586 VW-1 600 V, 125°C	LR31929 VW-1 600 V, 125°C	RW-3023

Available in:	Americas	Europe	Asia Pacific
	■	■	■

Product Dimensions

Versafit V2 (Continued)

Size	Inside Diameter		Wall Thickness	
	Expanded as Supplied	Maximum Recovered After Heating	Expanded as Supplied (Nominal)	Recovered* After Heating (Minimum)
1.0	1.5 ± 0.2 [0.059 ± 0.008]	0.50 [0.020]	0.20 [0.008]	0.33 [0.013]
1.5	2.1 ± 0.2 [0.075 ± 0.008]	0.75 [0.030]	0.20 [0.008]	0.35 [0.014]
2.0	2.6 ± 0.2 [0.102 ± 0.008]	1.00 [0.039]	0.25 [0.010]	0.43 [0.017]
2.5	3.1 ± 0.2 [0.122 ± 0.008]	1.25 [0.049]	0.25 [0.010]	0.43 [0.017]
3.0	3.6 ± 0.2 [0.142 ± 0.008]	1.50 [0.059]	0.25 [0.010]	0.43 [0.017]
3.5	4.1 ± 0.3 [0.161 ± 0.012]	1.75 [0.069]	0.25 [0.010]	0.43 [0.017]
4.0	4.6 ± 0.3 [0.181 ± 0.012]	2.00 [0.079]	0.25 [0.010]	0.43 [0.017]
5.0	5.6 ± 0.3 [0.221 ± 0.012]	2.50 [0.098]	0.30 [0.012]	0.56 [0.022]
6.0	6.6 ± 0.3 [0.260 ± 0.012]	3.00 [0.118]	0.30 [0.012]	0.56 [0.022]
7.0	7.6 ± 0.3 [0.299 ± 0.012]	3.50 [0.138]	0.30 [0.012]	0.56 [0.022]
8.0	8.6 ± 0.3 [0.339 ± 0.012]	4.00 [0.158]	0.30 [0.012]	0.56 [0.022]
9.0	9.6 ± 0.3 [0.378 ± 0.012]	4.50 [0.177]	0.30 [0.012]	0.56 [0.022]
10.0	10.4 ± 0.3 [0.409 ± 0.012]	5.00 [0.197]	0.30 [0.012]	0.56 [0.022]
11.0	11.4 ± 0.3 [0.449 ± 0.012]	5.50 [0.217]	0.30 [0.012]	0.56 [0.022]
12.0	12.7 ± 0.3 [0.500 ± 0.012]	6.00 [0.236]	0.30 [0.012]	0.56 [0.022]
13.0	13.5 ± 0.3 [0.532 ± 0.012]	6.50 [0.256]	0.35 [0.014]	0.66 [0.026]
14.0	14.4 ± 0.4 [0.567 ± 0.016]	7.00 [0.276]	0.35 [0.014]	0.68 [0.027]
15.0	15.7 ± 0.4 [0.618 ± 0.016]	7.50 [0.295]	0.35 [0.014]	0.68 [0.027]
16.0	16.9 ± 0.4 [0.665 ± 0.016]	8.00 [0.315]	0.35 [0.014]	0.68 [0.027]
18.0	19.0 ± 0.4 [0.748 ± 0.016]	9.00 [0.354]	0.40 [0.016]	0.76 [0.030]
20.0	21.4 ± 0.4 [0.843 ± 0.016]	10.00 [0.394]	0.40 [0.016]	0.76 [0.030]
22.0	23.2 ± 0.4 [0.913 ± 0.016]	11.00 [0.433]	0.45 [0.018]	0.89 [0.035]
25.0	26.8 ± 0.4 [1.055 ± 0.016]	12.50 [0.492]	0.45 [0.018]	0.89 [0.035]
27.0	28.2 ± 0.5 [1.110 ± 0.020]	12.50 [0.492]	0.45 [0.018]	0.89 [0.035]
28.0	30.0 ± 0.5 [1.181 ± 0.020]	14.00 [0.551]	0.45 [0.018]	0.89 [0.035]
30.0	32.1 ± 0.5 [1.264 ± 0.020]	15.00 [0.591]	0.45 [0.018]	0.89 [0.035]

*Wall thickness will be less if tubing recovery is restricted during shrinkage.

Ordering Information

Color	Standard	Black (-0)
	Nonstandard	White (-9), red (-2), blue (-6), yellow (-4), green (-5), orange (-3), violet (-7), brown (-1), gray (-8)
Size selection	Always order the largest size that will shrink snugly over the component to be covered. Special order sizes are available upon request.	
Standard packaging	On spools.	
Ordering description	Specify product name, size and color (for example, Versafit V2-3.0-0).	

Very-Thin-Wall, Very Flexible, Highly Flame-Retardant, Polyolefin Tubing

Product Facts

- 2:1 shrink ratio
- Very thin wall provides space savings and rapid shrinking
- Low shrink temperature further reduces installation time and risk of damage to temperature-sensitive components
- Very flexible; doesn't easily wrinkle when bent
- Free of polybrominated biphenyls (PBBs) and polybrominated biphenyl oxides and ethers (PBBOs and PBBEs), which are classified as environmentally hazardous substances



Versafit V4

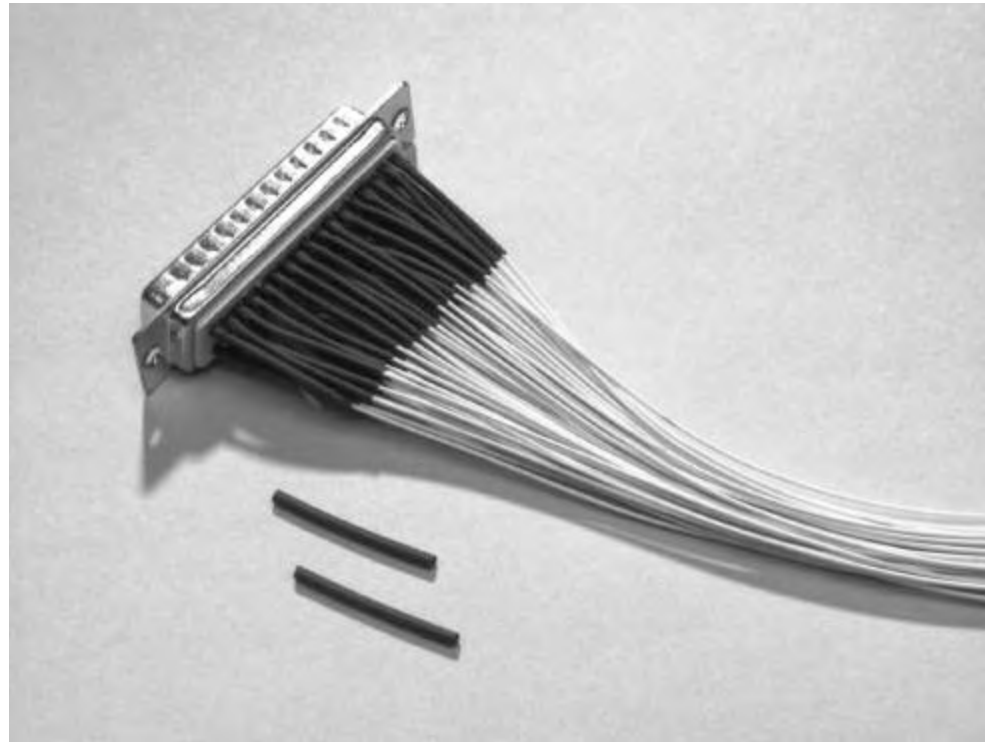

Applications

Typically used where space saving is important. Offers the ability to pack components more closely than is possible with standard tubings. Cost-effective choice for many commercial applications; electrically insulates and protects in-line components, disconnect terminals, and splices. Used for strain relief on high-density connectors.



Installation

Minimum shrink temperature: 70°C [158°F]
 Minimum full recovery temperature: 90°C [194°F]

Operating Temperature Range

-30°C to 125°C
 [-22°F to 257°F]

Specifications/Approvals

Series	UL 	CSA 	Raychem
Versafit V4	E85381 VW-1 300 V, 125°C	LR31929 VW-1 150 V, 125°C	RW-3023

Available in:	Americas	Europe	Asia Pacific
	■	■	■

Product Dimensions

Versafit V4 (Continued)

Metric Size	Inside Diameter		Wall Thickness	
	Expanded as Supplied	Maximum Recovered After Heating	Expanded as Supplied (Nominal)	Recovered* After Heating (Minimum)
0.6/0.3	0.95 ± 0.25 [0.037 ± 0.010]	0.30 [0.012]	0.10 [0.004]	0.25 [0.010]
0.8/0.4	1.20 ± 0.25 [0.047 ± 0.010]	0.40 [0.016]	0.10 [0.004]	0.25 [0.010]
1.0/0.5	1.40 ± 0.25 [0.055 ± 0.010]	0.50 [0.020]	0.10 [0.004]	0.25 [0.010]
1.5/0.75	1.90 ± 0.25 [0.075 ± 0.010]	0.75 [0.030]	0.10 [0.004]	0.25 [0.010]
2.0/1.0	2.30 ± 0.25 [0.091 ± 0.010]	1.00 [0.039]	0.10 [0.004]	0.25 [0.010]
2.5/1.25	2.80 ± 0.25 [0.110 ± 0.010]	1.25 [0.049]	0.15 [0.006]	0.25 [0.010]
3.0/1.5	3.30 ± 0.25 [0.130 ± 0.010]	1.50 [0.059]	0.15 [0.006]	0.25 [0.010]
3.5/1.75	3.80 ± 0.25 [0.150 ± 0.010]	1.75 [0.069]	0.15 [0.006]	0.25 [0.010]
4.0/2.0	4.40 ± 0.25 [0.173 ± 0.010]	2.00 [0.079]	0.15 [0.006]	0.25 [0.010]
5.0/2.5	5.50 ± 0.25 [0.217 ± 0.010]	2.50 [0.098]	0.15 [0.006]	0.25 [0.010]
6.0/3.0	6.50 ± 0.40 [0.256 ± 0.016]	3.00 [0.118]	0.15 [0.006]	0.28 [0.011]
7.0/3.5	7.50 ± 0.40 [0.295 ± 0.016]	3.50 [0.138]	0.15 [0.006]	0.28 [0.011]
8.0/4.0	8.50 ± 0.40 [0.335 ± 0.016]	4.00 [0.158]	0.15 [0.006]	0.28 [0.011]
9.0/4.5	9.50 ± 0.40 [0.374 ± 0.016]	4.50 [0.177]	0.15 [0.006]	0.28 [0.011]
10.0/5.0	10.50 ± 0.50 [0.413 ± 0.020]	5.00 [0.197]	0.15 [0.006]	0.28 [0.011]

Inch Size	Inside Diameter		Recovered Wall Thickness* After Heating
	Minimum Expanded as Supplied	Maximum Recovered After Heating	
3/64	1.2 [0.046]	0.6 [0.023]	0.30 ± 0.05 [0.012 ± 0.002]
1/16	1.6 [0.062]	0.8 [0.031]	0.30 ± 0.05 [0.012 ± 0.002]
3/32	2.4 [0.093]	1.2 [0.046]	0.30 ± 0.05 [0.012 ± 0.002]
1/8	3.2 [0.125]	1.6 [0.062]	0.33 ± 0.05 [0.013 ± 0.002]
3/16	4.8 [0.187]	2.4 [0.093]	0.33 ± 0.05 [0.013 ± 0.002]
1/4	6.4 [0.250]	3.2 [0.125]	0.36 ± 0.08 [0.014 ± 0.003]
3/8	9.5 [0.375]	4.8 [0.187]	0.36 ± 0.08 [0.014 ± 0.003]
1/2	12.7 [0.500]	6.4 [0.250]	0.36 ± 0.08 [0.014 ± 0.003]
3/4	19.1 [0.750]	9.5 [0.375]	0.43 ± 0.08 [0.017 ± 0.003]
1	25.4 [1.000]	12.7 [0.500]	0.51 ± 0.08 [0.020 ± 0.003]

*Wall thickness will be less if tubing recovery is restricted during shrinkage.

Ordering Information

Color	Standard	Black (-0)
	Nonstandard	Other colors available upon request.
Size selection	Always order the largest size that will shrink snugly over the component to be covered. Special order sizes are available upon request.	
Standard packaging	On spools.	
Marking	Marked with UL/CSA/-F- legends (metric sizes) or unmarked (inch sizes).	
Ordering description	Specify product name, size (mm or in.) and color (for example, Versafit V4-1.0-0).	

High-Shrink-Ratio,
Adhesive-Lined
Polyolefin Tubing

Product Facts

- 3:1 and 4:1 shrink ratios allow for connector-to-cable sealing
- Tubing environmentally seals and protects components and interconnections
- Medium wall provides increased mechanical protection
- ATUM adhesive bonds to a wide variety of plastics, rubbers, and metals, including polyethylene, aluminum, steel, and copper



ATUM



Applications

Environmentally seals and protects a wide variety of electrical applications, including back end connector sealing, breakouts, and connector-to-cable transitions. High expansion ratio makes it possible to repair most damaged cable jackets without removing connectors.

Installation

Minimum shrink temperature: 80°C [176°F]
Minimum full recovery temperature: 110°C [230°F]

Operating Temperature Range

-55°C to 110°C
[-67°F to 230°F]

Specifications/Approvals

Series	UL**	Military	Raychem
ATUM	E85381 600V, 110°C	AMS-DTL-23053/4*, Class 3	RW-2063 - Black RK-6024 - Colors and clear

*Formerly MIL-I-23053/4 and MIL-DTL-23053/4. Sizes 3/1, 6/2, 12/4, 24/8, and 40/13 only.
**Black only, except sizes 3/1 and 4/1.

Available in:	Americas	Europe	Asia Pacific
	■	■	■

Product Dimensions

ATUM (Continued)

Size	Inside Diameter		Recovered Wall Thickness**	
	Minimum Expanded as Supplied	Maximum Recovered After Heating	Total Wall After Heating	Adhesive Wall After Heating (Nominal)
3:1				
3/1	3.0 [0.118]	1.0 [0.039]	1.00 ± 0.28 [0.039 ± 0.010]	0.50 [0.020]
4.5/1.5	4.5 [0.177]	1.5 [0.059]	1.10 ± 0.25 [0.043 ± 0.011]	0.50 [0.020]
6/2	6.0 [0.236]	2.0 [0.079]	1.00 ± 0.28 [0.039 ± 0.010]	0.50 [0.020]
9/3	9.0 [0.354]	3.0 [0.118]	1.40 ± 0.28 [0.055 ± 0.010]	0.61 [0.024]
12/4	12.0 [0.472]	4.0 [0.157]	1.78 ± 0.38 [0.070 ± 0.015]	0.76 [0.030]
19/6	19.0 [0.748]	6.0 [0.236]	2.25 ± 0.55 [0.088 ± 0.022]	0.76 [0.030]
24/8	24.0 [0.940]	8.0 [0.315]	2.54 ± 0.55 [0.100 ± 0.022]	1.02 [0.040]
40/13	40.0 [1.570]	13.0 [0.512]	2.54 ± 0.55 [0.100 ± 0.022]	1.02 [0.040]
4:1				
4/1	4.0 [0.158]	1.0 [0.039]	1.00 ± 0.28 [0.039 ± 0.010]	0.50 [0.020]
8/2	8.0 [0.315]	2.0 [0.079]	1.00 ± 0.28 [0.039 ± 0.010]	0.50 [0.020]
12/3	12.0 [0.472]	3.0 [0.118]	1.40 ± 0.28 [0.055 ± 0.010]	0.61 [0.024]
16/4	16.0 [0.630]	4.0 [0.158]	1.78 ± 0.38 [0.070 ± 0.015]	0.76 [0.030]
24/6	24.0 [0.945]	6.0 [0.236]	2.25 ± 0.55 [0.088 ± 0.022]	0.76 [0.030]
32/8	32.0 [1.260]	8.0 [0.315]	2.54 ± 0.55 [0.100 ± 0.022]	1.02 [0.040]
52/13	52.0 [2.050]	13.0 [0.512]	2.54 ± 0.55 [0.100 ± 0.022]	1.02 [0.040]

**Wall thickness will be less if tubing recovery is restricted during shrinkage.

Ordering Information

Color	Standard	Black (-0)
	Nonstandard	Clear in 3:1 sizes only (non-flame-retardant jacket); other colors available on request.
Size selection	Always order the largest size that will shrink snugly over the component to be covered. Special order sizes are available upon request.	
Standard packaging	In 1.2-meter [4-foot] lengths.	
Ordering description***	Specify product name, size and color (for example, ATUM 8/2-0).	

***Europe Only. For supply to MIL, Def Stan and BS add -MS, -DS or -BS to ordering description.

Flexible, High-Shrink-Ratio, Adhesive-Lined, Polyolefin Tubing

Product Facts

- 3:1 shrink ratio allows for insulation and sealing of irregular shapes
- Medium wall provides increased mechanical protection while maintaining flexibility when installed
- Adhesive bonds to a wide variety of plastics, rubber, and metals, including polyethylene, neoprene, and steel



DWP-125



3 Heat-Shrinkable Tubing

Applications

Environmentally seals and protects a wide variety of electrical applications, including wire splices, breakouts, and connector-to-cable transitions. Ideal for applications where UL recognized/CSA certified adhesive-lined tubing is required.

Installation

Minimum shrink temperature: 80°C [176°F]
Minimum full recovery temperature: 125°C [257°F]

Operating Temperature Range

-40°C to 110°C
[-40°F to 230°F]

Specifications/Approvals

Series	UL	CSA	Military	Raychem
DWP-125	E35586 600 V, 125°C	LR31929 600 V, 125°C	AMS-DTL-23053/4*, Class 3 (colors only)	DWP-125 SCD

*Formerly MIL-I-23053/4 and MIL-DTL-23053/4. Meets the material properties except for Sealing Efficiency.

Available in:	Americas	Europe	Asia Pacific
	■	■	■

Product Dimensions

DWP-125 (Continued)

Size	Inside Diameter		Recovered Wall Thickness*	
	Minimum Expanded as Supplied	Maximum Recovered After Heating	Nominal Total Wall After Heating	Nominal Adhesive Wall After Heating
1/8	3.2 [0.125]	1.0 [0.040]	1.02 [0.040]	0.25 [0.010]
3/16	4.8 [0.187]	1.5 [0.060]	1.40 [0.055]	0.51 [0.020]
1/4	6.4 [0.250]	2.0 [0.080]	1.45 [0.057]	0.56 [0.022]
3/8	9.5 [0.375]	3.0 [0.120]	1.65 [0.065]	0.68 [0.027]
1/2	12.7 [0.500]	4.0 [0.157]	1.78 [0.070]	0.76 [0.030]
3/4	19.1 [0.750]	6.0 [0.230]	2.03 [0.080]	0.76 [0.030]
1	25.4 [1.000]	8.0 [0.320]	2.50 [0.100]	0.76 [0.030]

*Wall thickness will be less if tubing recovery is restricted during shrinkage.

Ordering Information

Color	Standard Nonstandard	Black (-0) White (-9), red (-2), blue (-6), yellow (-4), green (-5), clear (-X, non-flame-retardant jacket). Other colors available upon request.
Size selection	Always order the largest size that will shrink snugly over the component to be covered. Special order sizes are available upon request.	
Standard packaging	In 1.2-meter [4-foot] lengths.	
Ordering description	Specify product name, size and color (for example, DWP-125 1/4-0).	

ES1000

Clear, High-Shrink-Ratio, Adhesive-Lined, Semirigid Polyolefin Tubing

Product Facts

- 4:1 shrink ratio allows a few sizes to cover a wide range of splice and component diameters
- Mechanically tough tubing provides strain relief and abrasion protection of wire splices, terminals and other components
- Thick adhesive liner forms an effective barrier against fluids and moisture and performs well at an extended temperature range



Applications

Specially designed for environmental sealing and electrical insulation of wire splices, terminations, and components where see-through inspection is required.

Installation

Minimum shrink temperature: 110°C [230°F]
 Minimum full recovery temperature: 135°C [275°F]

Operating Temperature Range

-40°C to 130°C
 [-40°F to 266°F]

Specifications/Approvals

Series	UL 	Raychem
ES1000	E85381 600 V, 125°C	RT-1113

Available in:	Americas	Europe	Asia Pacific
	■		■

ES1000 (Continued)

Product Dimensions

Part Number	Inside Diameter (Including Core)		Recovered Wall Thickness*		
	Minimum Expanded as Supplied	Maximum Recovered After Heating	Minimum Total Wall After Heating	Minimum Jacket Wall After Heating	Minimum Adhesive Wall After Heating
ES1000-No.1	5.72 [0.225]	1.27 [0.050]	1.20 [0.047]	0.64 [0.025]	0.56 [0.022]
ES1000-No.2	7.44 [0.293]	1.65 [0.065]	1.52 [0.060]	0.76 [0.030]	0.76 [0.030]
ES1000-No.3	10.85 [0.427]	2.41 [0.095]	1.91 [0.075]	0.89 [0.035]	1.02 [0.040]
ES1000-No.4	17.78 [0.700]	4.45 [0.175]	2.41 [0.095]	1.04 [0.041]	1.37 [0.054]

*Wall thickness will be less if tubing recovery is restricted during shrinkage.

Ordering Information

Color	Standard	Clear (-X)
Size selection	Always order the largest size that will shrink snugly over the component to be covered.	
Standard packaging	Cut pieces.	
Marking	Tubing will be printed with its numbered size (such as ES-1, ES-2, ES-3, or ES-4).	
Ordering description	Specify product name, numbered size, color, and cut length (for example, ES1000-NO.2-X-50MM).	

ES2000

Flame-Retardant, High-Shrink-Ratio, Adhesive-Lined Semirigid Polyolefin Tubing

Product Facts

- 4:1 shrink ratio allows a few sizes to cover a wide range of splice and component diameters
- Flame-retardant and mechanically tough, the tubing provides strain relief and abrasion protection of wire splices, terminals, and other components
- Thick adhesive liner forms an effective barrier against fluids and moisture and performs well at an extended temperature range
- UL recognized



Applications

Specially designed for environmental sealing and electrical insulation of wire splices, terminations, and components.

Installation

Minimum shrink temperature: 110°C [230°F]
 Minimum full recovery temperature: 135°C [275°F]

Operating Temperature Range

-40°C to 130°C
 [-40°F to 266°F]

Specifications/Approvals

Series	UL 	Raychem
ES2000	E85381 600 V, 125°C	RT-1112

Available in:	Americas	Europe	Asia Pacific
	■		■

ES2000 (Continued)

Product Dimensions

Part Number	Inside Diameter (Including Core)		Recovered Wall Thickness*		
	Minimum Expanded as Supplied	Maximum Recovered After Heating	Minimum Total Wall After Heating	Minimum Jacket Wall After Heating	Minimum Adhesive Wall After Heating
ES2000-No.1	5.72 [0.225]	1.27 [0.050]	1.20 [0.047]	0.64 [0.025]	0.56 [0.022]
ES2000-No.2	7.44 [0.293]	1.65 [0.065]	1.52 [0.060]	0.76 [0.030]	0.76 [0.030]
ES2000-No.3	10.85 [0.427]	2.41 [0.095]	1.91 [0.075]	0.89 [0.035]	1.02 [0.040]
ES2000-No.4	17.78 [0.700]	4.45 [0.175]	2.41 [0.095]	1.04 [0.041]	1.37 [0.054]

*Wall thickness will be less if tubing recovery is restricted during shrinkage.

Ordering Information

Color	Standard	Black (-0)
Size selection	Always order the largest size that will shrink snugly over the component to be covered.	
Standard packaging	Cut pieces.	
Marking	Tubing will be printed with its numbered size (such as ES-1, ES-2, ES-3, or ES-4).	
Ordering description	Specify product name, numbered size, color, and cut length (for example, ES2000-NO.2-0-50MM).	

FL2500

Fully Flame-Retardant, Adhesive-Lined, Polyolefin Heat-Shrinkable Tubing

Product Facts

- 4:1 shrink ratio allows a few sizes to cover a wide range of wire terminations and components
- Flame-retardant tubing jacket and adhesive provide full flame-retardancy
- Fully flame-retardant and mechanically tough, the tubing provides strain relief and abrasion protection of wire splices, terminals and other components
- Thick high-performance adhesive lining offers permanent sealing of splices, fusible links, terminals and in-line components



Applications

Tough flame-retardant polyolefin tubing lined with a flame-retardant adhesive provides the optimum solution for applications where full flame-retardancy is preferred or specified.

Rated to 135°C [275°F] for 3000 hours, it is suitable for use on harnesses which will be exposed to harsh environments. As the tubing shrinks, the adhesive lining melts and flows to fill all voids and create a complete seal against moisture, oils, chemicals and other fluids.

Installation

Minimum shrink temperature: 110°C [230°F]
 Minimum full recovery temperature: 135°C [275°F]

Operating Temperature Range

-40°C to 135°C
 [-40°F to 275°F]

Specifications/Approvals

Series	Raychem
FL2500	FL2500 SCD

Available in:	Americas	Europe	Asia Pacific
	■	■	■

Product Dimensions

FL2500 (Continued)

Part Number	Inside Diameter (Including Core)		Recovered Wall Thickness*	
	Minimum Expanded as Supplied	Maximum Recovered After Heating	Total Wall After Heating	Minimum Adhesive Wall After Heating
FL2500-No. 1	7.62 [0.300]	1.65 [0.065]	1.52 ± 0.3 [0.060 ± 0.012]	0.762 [0.030]
FL2500-No. 2	9.02 [0.355]	2.29 [0.090]	1.52 ± 0.3 [0.060 ± 0.012]	0.762 [0.030]
FL2500-No. 3	11.56 [0.455]	2.54 [0.100]	2.29 ± 0.3 [0.090 ± 0.012]	1.397 [0.055]
FL2500-No. 4	17.79 [0.700]	4.45 [0.175]	2.54 ± 0.3 [0.100 ± 0.012]	1.524 [0.060]

*Wall thickness will be less if tubing recovery is restricted during shrinkage.

Ordering Information

Color	Black (-0) with a white adhesive liner
Size selection	Always order the largest size that will shrink snugly over the component to be covered.
Standard packaging	Cut pieces.
Marking	Tubing will be marked with its numbered size (such as FL-1, FL-2, FL-3, FL-4).
Ordering description	Specify product name, size, color, and cut length (for example, FL2500-NO.2-0-50MM).

Semiflexible, Dual Wall,
Moisture-Resistant,
Heat-Shrinkable Tubing

Product Facts

- 4:1 shrink ratio
- Environmental sealing
- High-strength bonding
- Ideal connector sealing covering large diameter differences



HTAT



Applications

Designed to provide environmental sealing for a range of substrates, at elevated temperatures. Manufactured by Tyco Electronics from radiation-crosslinked polyolefins, the inner wall melts when heated and is forced into interstices by the shrinking of the outer wall so that, when cooled, the substrate is encapsulated by a tough, protective moisture barrier. An operating range of -55°C to 125°C [-67°F to 257°F] and a high shrink ratio as standard, mean that the tubing offers superior environmental protection to a wide range of irregular shapes with varying dimensions. The jacket is flame-retardant to reduce flame propagation.

Installation

Minimum shrink temperature: 80°C [176°F]
Minimum full recovery temperature: 110°C [230°F]

Operating Temperature Range

-55°C to 125°C
[-67°F to 257°F]

Specifications/Approvals

Series	Raychem
HTAT	RW-2052

Available in:	Americas	Europe	Asia Pacific
	■	■	■

Product Dimensions

HTAT (Continued)

Size	Inside Diameter		Recovered Wall Thickness*	
	Minimum Expanded as Supplied	Maximum Recovered After Heating	Nominal Total Wall After Heating	Nominal Adhesive Wall After Heating
4/1	4.0 [0.158]	1.0 [0.039]	1.00 [0.039]	0.40 [0.016]
8/2	8.0 [0.315]	2.0 [0.079]	1.00 [0.039]	0.50 [0.020]
12/3	12.0 [0.472]	3.0 [0.118]	1.40 [0.055]	0.60 [0.024]
16/4	16.0 [0.630]	4.0 [0.158]	1.75 [0.069]	0.75 [0.030]
24/6	24.0 [0.945]	6.0 [0.236]	2.25 [0.088]	0.80 [0.032]
32/8	32.0 [1.260]	8.0 [0.315]	2.50 [0.098]	1.00 [0.039]
48/13	48.0 [1.890]	13.0 [0.512]	2.55 [0.100]	1.00 [0.039]

*Wall thickness will be less if tubing recovery is restricted during shrinkage.

Ordering Information

Color	Standard	Black (-0)
Size selection	Always order the largest size that will shrink snugly over the component to be covered. Special order sizes are available upon request.	
Standard packaging	In 1.2 meter [4-ft] lengths.	
Ordering description	Specify product name, size and color (for example, HTAT 8/2-0).	

Flexible, Dual Wall,
Moisture Proof,
Heat-Shrinkable Tubing

Product Facts

- Environmental sealing
- Excellent mechanical strength
- Abrasion resistance
- 4:1 shrink ratio



RPPM



Applications

RPPM is a flexible, heat-shrinkable, dual wall tubing with an integrally bonded meltable adhesive liner. Available in clear and black, the tough outer jacket offers excellent mechanical strength. RPPM is used for moisture proof encapsulation of a wide variety of components. In particular, it adheres well to PVC. The high shrink ratio allows RPPM to be used with a range of dimensions. Clear RPPM offers excellent clarity for protection of substrates that may need to be inspected during service. Black RPPM has a high gloss finish suitable for cosmetic applications.

Installation

Minimum shrink temperature: 60°C [140°F]
Minimum full recovery temperature: 80°C [176°F]

Operating Temperature Range

-40°C to 85°C
[-40°F to 185°F]

Specifications/Approvals

Series	Raychem
RPPM	RK-6214

Available in:	Americas	Europe	Asia Pacific
	■	■	■

Product Dimensions

RPPM (Continued)

Size	Inside Diameter		Recovered Wall Thickness*	
	Minimum Expanded as Supplied	Maximum Recovered After Heating	Nominal Total Wall After Heating	Nominal Adhesive Wall After Heating
4/1	4.0 [0.158]	1.0 [0.039]	0.8 [0.032]	0.3 [0.012]
8/2	8.0 [0.315]	2.0 [0.079]	0.9 [0.035]	0.3 [0.012]
12/3	12.0 [0.472]	3.0 [0.118]	1.2 [0.047]	0.4 [0.016]
16/4	16.0 [0.630]	4.0 [0.158]	1.5 [0.059]	0.5 [0.020]

*Wall thickness will be less if tubing recovery is restricted during shrinkage.

Ordering Information

Color	Standard	Clear (-X)
	Nonstandard	Black (-0)
Size selection	Always order the largest size that will shrink snugly over the component to be covered. Special order sizes are available upon request.	
Standard packaging	On spools, in 1.2 meter [4-foot] lengths or cut pieces.	
Ordering description	Specify product name, size and color (for example, RPPM 4/1-X).	

Semirigid,
Encapsulant-Lined,
Polyolefin Tubing

Product Facts

- 3:1 shrink ratio
- Splash-resistant, moisture-resistant covering; not intended for use where immersion in fluids is required
- Rugged protection against abrasion, vibration, and flexing
- Excellent strain relief and insulation of weak points



SCL



Applications

Encapsulates components, splices, and terminations where moisture resistance and mechanical protection are required. Encapsulant melts and flows to fill surface irregularities of the substrate. While still hot, the tubing can be blocked to form a wire breakout.

Installation

Minimum shrink temperature: 125°C [257°F]
Minimum full recovery temperature: 135°C [275°F]

Operating Temperature Range

-55°C to 110°C
[-67°F to 230°F]

Specifications/Approvals

Series	UL 	Military	Raychem
SCL	E85381 600 V, 125°C	AMS-DTL-23053/4*, Class 1	RT-1301

*Formerly MIL-I-23053/4 and MIL-DTL-23053/4.

Available in:	Americas	Europe	Asia Pacific
	■	■	■

Product Dimensions

SCL (Continued)

Size	Additional Standard Color	Inside Diameter		Recovered Wall Thickness**	
		Minimum Expanded as Supplied	Maximum Recovered After Heating	Total Wall After Heating	Meltable Wall After Heating (Nominal)
1/8	Brown	3.2 [0.125]	0.6 [0.023]	0.96 ± 0.15 [0.038 ± 0.006]	0.51 [0.020]
3/16	Gray	4.8 [0.187]	1.5 [0.060]	1.09 ± 0.15 [0.043 ± 0.006]	0.64 [0.025]
1/4	White	6.4 [0.250]	2.0 [0.080]	1.19 ± 0.15 [0.047 ± 0.006]	0.69 [0.027]
3/8	Red	9.5 [0.375]	3.4 [0.135]	1.27 ± 0.18 [0.050 ± 0.007]	0.76 [0.030]
1/2	Blue	12.7 [0.500]	5.0 [0.195]	1.39 ± 0.18 [0.055 ± 0.007]	0.89 [0.035]
3/4	Yellow	19.1 [0.750]	8.0 [0.313]	1.65 ± 0.18 [0.065 ± 0.007]	1.02 [0.040]
1	N/A	25.4 [1.000]	10.2 [0.400]	1.90 ± 0.18 [0.075 ± 0.007]	1.02 [0.040]

**Wall thickness will be less if tubing recovery is restricted during shrinkage.

Ordering Information

Color	Standard	Black (-0) for all sizes, plus one additional color per size per Product Dimensions table.
Size selection	Always order the largest size that will shrink snugly over the component to be covered. Special order sizes are available upon request.	
Standard packaging	In 1.2-meter [4-foot] lengths.	
Ordering description***	Specify product name, size and color (for example, SCL 1/4-0).	

***Europe only. For supply to MIL, Def Stan and BS add -MS, -DS or -BS to ordering description.

SCT

Flame-Retardant, Adhesive-Lined, Semirigid Polyolefin Tubing (Extended Temperature Range)

Product Facts

- 4:1 shrink ratio allows a few sizes to cover a wide range of splice and component diameters
- Flame-retardant and mechanically tough, the tubing provides strain relief and abrasion protection of wire splices, terminals, and other components
- Thick adhesive liner forms an effective barrier against fluids and moisture and performs well at an extended temperature range



Applications

Specially designed to insulate and seal automotive wire splices and components in an under-the-hood automotive environment. Specially formulated to function at an extended temperature range.

Installation

Minimum shrink temperature: 110°C [230°F]
 Minimum full recovery temperature: 135°C [266°F]

Operating Temperature Range

-40°C to 150°C
 [-40°F to 302°F]

Specifications/Approvals

Series	Raychem
SCT	SCT SCD

Available in:	Americas	Europe	Asia Pacific
	■	■	■

Product Dimensions

SCT (Continued)

Part Number	Inside Diameter		Recovered Wall Thickness*	
	Minimum Expanded as Supplied	Maximum Recovered After Heating	Total Wall After Heating	Meltable Wall After Heating (Nominal)
SCT No. 1	7.6 [0.300]	1.7 [0.065]	1.52 ± 0.30 [0.060 ± 0.012]	0.76 [0.030]
SCT No. 2	9.0 [0.355]	2.3 [0.090]	1.52 ± 0.30 [0.060 ± 0.012]	0.76 [0.030]
SCT No. 3	11.6 [0.455]	2.5 [0.100]	2.29 ± 0.30 [0.090 ± 0.012]	1.40 [0.055]
SCT No. 4	17.8 [0.700]	4.4 [0.175]	2.54 ± 0.30 [0.100 ± 0.012]	1.52 [0.060]

*Wall thickness will be less if tubing recovery is restricted during shrinkage.

Ordering Information

Color	Black
Size selection	Always order the largest size that will shrink snugly over the component being covered. Special order sizes are available upon request.
Standard packaging	Cut pieces.
Marking	Tubing will be printed with its numbered size (such as SCT-1, SCT-2, SCT-3, SCT-4).
Ordering description	Specify product name, numbered size, color and cut length (for example, SCT-NO.3-0-75MM).

Adhesive-Lined,
Flexible,
Polyolefin Tubing

Product Facts

- 2:1 shrink ratio
- Thin adhesive lining that bonds to outer tubing and surface below, forming a positive environmental seal
- Flexibility of both tubing and adhesive
- Moisture seal that is resistant to bending of the substrate
- Good mechanical strength and cut-through resistance
- Adhesive that bonds to a wide variety of plastics, rubbers, and metals, including polyethylene, neoprene, lead, and steel



TAT-125



3 Heat-Shrinkable Tubing

Applications

Seals and protects simple in-line splices, bimetallic joints, and components from fluids, moisture, and corrosion. Repairs damaged wire insulation, especially where flexibility is required. Provides one-step electrical insulation and moisture sealing.

Installation

Minimum shrink temperature: 95°C [203°F]
Minimum full recovery temperature: 121°C [250°F]

Operating Temperature Range

-55°C to 110°C
[-67°F to 230°F]

Specifications/Approvals

Series	UL	Military	Raychem
TAT-125 Type 1 (colors)	E85381 600 V, 125°C	AMS-DTL-23053/4*, Class 2	TAT-125 SCD
TAT-125 Type 2 (clear)	—	—	TAT-125 SCD

*Formerly MIL-I-23053/4 and MIL-DTL-23053/4. Sizes 1/4" through 1 1/2" only.

Available in:	Americas	Europe	Asia Pacific
	■		■

Product Dimensions

TAT-125 (Continued)

Size	Inside Diameter		Recovered Wall Thickness**	
	Minimum Expanded as Supplied	Maximum Recovered After Heating	Total Wall After Heating (Nominal)	Adhesive Wall After Heating (Nominal)
1/8	3.2 [0.125]	1.6 [0.062]	0.69 [0.027]	0.23 [0.009]
3/16	4.8 [0.187]	2.4 [0.093]	0.71 [0.028]	0.25 [0.010]
1/4	6.4 [0.250]	3.2 [0.125]	0.74 [0.029]	0.13 [0.005]
3/8	9.5 [0.375]	4.8 [0.187]	0.74 [0.029]	0.13 [0.005]
1/2	12.7 [0.500]	6.4 [0.250]	0.76 [0.030]	0.15 [0.006]
3/4	19.1 [0.750]	9.5 [0.375]	0.89 [0.035]	0.15 [0.006]
1	25.4 [1.000]	12.7 [0.500]	1.07 [0.042]	0.20 [0.008]
1 1/2	38.1 [1.500]	19.1 [0.750]	1.19 [0.047]	0.28 [0.011]

**Wall thickness will be less if tubing recovery is restricted during shrinkage.

Ordering Information

Color	Standard	Black (-0)
	Nonstandard	White (-9), red (-2), blue (-6), yellow (-4), green (-5), brown (-1), orange (-3), violet (-7), gray (-8), clear (-X , not flame-retardant)
Size selection	Always order the largest size that will shrink snugly over the component to be covered. Special order sizes are available upon request.	
Standard packaging	In 1.2-meter [4-foot] lengths.	
Ordering description	Specify product name, size and color (for example, TAT-125 1/4-0).	

General Purpose,
Heat-Shrinkable Tubing

Product Facts

- Excellent thick-wall insulation and abrasion protection
- No adhesive – can be removed easily
- Expansion ratios as high as 3:1
- Availability in flame-retardant material with FR callout (see “Ordering information and Part numbering system” on the next page)
- BSTS has the following agency approvals:
 - ABS (American Bureau of Shipping)
 - DNV (Det Norske Veritas)
 - Lloyd's (Lloyd's Register of Shipping)



BSTS/BSTS-FR

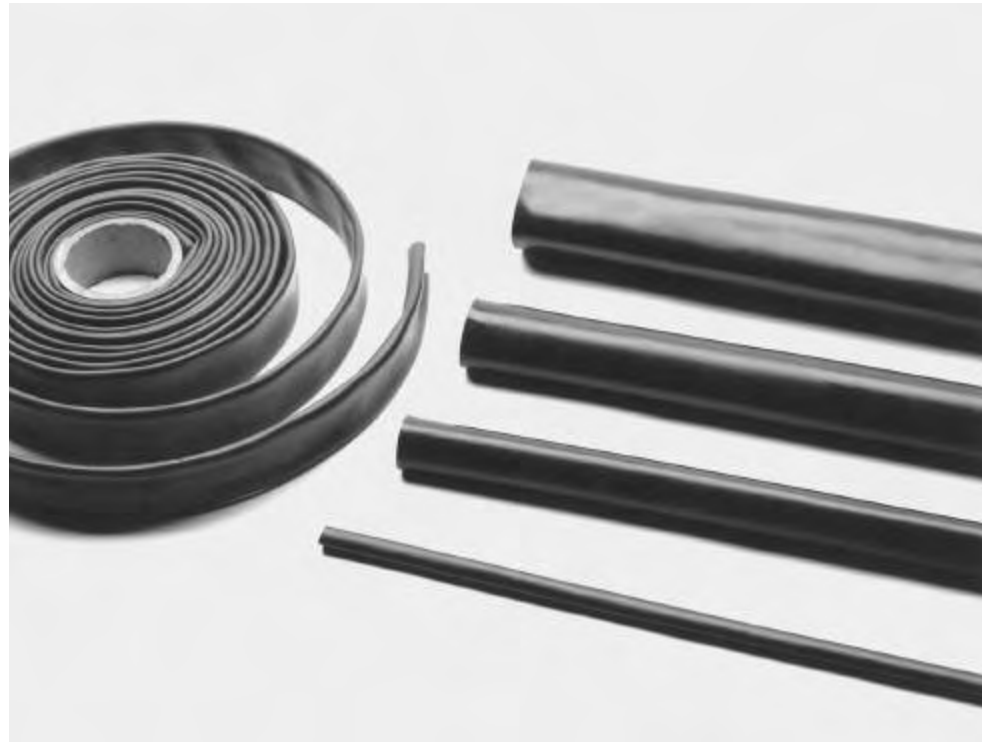

Applications

BSTS heat-shrinkable tubing is made of a rugged polymer that resists moisture, fungus, and weathering. It also has excellent electrical properties. This tubing is useful in applications where insulation, abrasion resistance, and strain relief are important. When used with SFTS tape sealant, it can provide a watertight system in nonpressurized applications.

Installation

Minimum shrink temperature: 90°C [194°F]
Minimum full recovery temperature: 121°C [250°F]

Operating Temperature Range

-55°C to 90°C
[-67°F to 194°F]

Specifications/Approvals

Series	Military	Industry	Raychem
BSTS	—	—	RW-2017
BSTS-FR	AMS-DTL-23053/15*, Class 1 and Class 2**	ASTM D 685, nonburning ASTM D 2863, oxygen index IPCEA S-19-81, cable insulation and jackets	RW-2017

*Formerly MIL-I-23053/15 and MIL-DTL-23053/15.

**Except for coatings requirement. Refer to SST-FR when coating is required.

Available in:	Americas	Europe	Asia Pacific
	■	■	■

BSTS/BSTS-FR (Continued)

Product Dimensions

Size	Inside Diameter		Wall Thickness (Nominal)	
	Minimum Expanded as Supplied	Maximum recovered After Heating	Expanded as Supplied	Recovered After Heating****
BSTS-03	7.62 [0.300]	2.54 [0.100]	0.63 [0.025]	1.52 [0.060]
BSTS-04	10.16 [0.400]	3.81 [0.150]	0.63 [0.025]	1.52 [0.060]
BSTS-07M***	19.05 [0.750]	5.59 [0.220]	0.51 [0.020]	1.52 [0.060]
BSTS-07	19.05 [0.750]	5.59 [0.220]	0.76 [0.030]	2.41 [0.095]
BSTS-11M	27.94 [1.100]	9.52 [0.375]	0.76 [0.030]	2.67 [0.110]
BSTS-11	27.94 [1.100]	9.52 [0.375]	1.02 [0.040]	3.05 [0.120]
BSTS-13M	33.02 [1.300]	9.52 [0.375]	0.63 [0.025]	2.67 [0.110]
BSTS-13	33.02 [1.300]	9.52 [0.375]	0.89 [0.035]	3.05 [0.120]
BSTS-15M	38.10 [1.500]	12.70 [0.500]	0.89 [0.035]	3.05 [0.120]
BSTS-15	38.10 [1.500]	12.70 [0.500]	1.27 [0.050]	3.56 [0.140]
BSTS-17M	43.18 [1.700]	12.70 [0.500]	1.02 [0.040]	3.05 [0.120]
BSTS-17	43.18 [1.700]	12.70 [0.500]	1.14 [0.045]	3.56 [0.140]
BSTS-20M	50.80 [2.000]	19.05 [0.750]	1.27 [0.050]	3.05 [0.120]
BSTS-20	50.80 [2.000]	19.05 [0.750]	1.27 [0.050]	3.94 [0.160]
BSTS-27	65.58 [2.700]	22.86 [0.900]	1.27 [0.050]	3.94 [0.160]
BSTS-30	76.20 [3.000]	31.75 [1.250]	1.27 [0.050]	3.94 [0.160]
BSTS-35	88.90 [3.500]	31.75 [1.250]	1.27 [0.050]	3.94 [0.160]
BSTS-40	101.60 [4.000]	44.45 [1.750]	1.27 [0.050]	3.94 [0.160]
BSTS-45	114.30 [4.500]	44.45 [1.750]	1.27 [0.050]	3.94 [0.160]

M = Medium wall tubing. *Wall thickness will be less if tubing recovery is restricted during shrinkage.

Ordering Information

Color	Standard	Black (-0)
	Nonstandard	Red (-2), white (-9), clear (-X not flame-retardant)
Size selection	Always order the largest size that will shrink snugly over the component to be covered. Special order sizes are available upon request.	
Standard packaging	1.2-meter [4-foot] or 7.5-meter [25-foot] lengths.	
Ordering description	See below.	

Part Numbering System

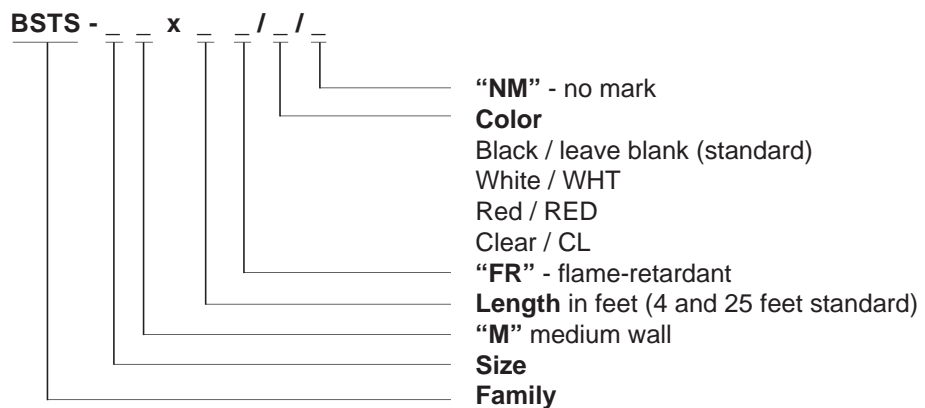

Example: BSTS-11MX4/NM

High-Flex, Heavy-Wall,
Heat-Shrinkable Tubing

Product Facts

- Offers high flexibility
- Provides excellent insulation and abrasion-protection, per U.S. Mine Safety and Health Administration (MSHA) regulations
- Flame-retardant
- HF has the following agency approvals:
 - ABS (American Bureau of Shipping)
 - DNV (Det Norske Veritas)
 - Lloyd's (Lloyd's Register of Shipping)

HF



Applications

Developed for cable jacketing applications where cable flexibility is important, high-flex (HF) tubing is ideal for jacketing cables where sharp bends or turns are required. Also ideal for situations where the cable is subject to motion. Such situations are common for industrial machinery, transportation equipment, robotics, welding, and many other cabling applications. To complete the cable jacket seal, the ends may be sealed for further water and corrosion protection by using available tape sealant or adhesive.

Installation

Minimum shrink temperature: 80°C [176°F]
Minimum full recovery temperature: 121°C [250°F]

Operating Temperature Range

-55°C to 90°C
[-67°F to 194°F]

Specifications/Approvals

Series	Military	Raychem
HF	AMS-DTL-23053/15* Class 1**	RW-2023

*Formerly MIL-I-23053/15 and MIL-DTL-23053/15.
**Except for coatings requirement.

Available in:	Americas	Europe	Asia Pacific
	■	■	■

Product Dimensions

HF (Continued)

Size	Standard Nominal Length (m/ft)	Inside Diameter		Wall Thickness**
		Minimum Expanded as Supplied	Maximum Recovered After Heating	Nominal Recovered After Heating
HF04	1.2, 7.5 [4, 25]	10.16 [0.40]	3.81 [0.150]	1.52 [0.060]
HF07	1.2, 7.5 [4, 25]	19.05 [0.75]	5.59 [0.220]	1.52 [0.060]
HF11	1.2, 7.5 [4, 25]	27.94 [1.10]	9.52 [0.375]	2.67 [0.105]
HF13	1.2, 7.5 [4, 25]	33.02 [1.30]	9.52 [0.375]	2.67 [0.105]
HF15	1.2, 7.5 [4, 25]	38.10 [1.50]	12.70 [0.500]	3.05 [0.120]
HF17	1.2, 7.5 [4, 25]	43.14 [1.70]	12.70 [0.500]	3.05 [0.120]
HF20	1.2, 7.5 [4, 25]	50.80 [2.00]	19.05 [0.750]	3.56 [0.140]
HF27	1.2, 7.5 [4, 25]	68.58 [2.70]	22.86 [0.900]	3.94 [0.155]

**Wall thickness will be less if tubing recovery is restricted during shrinkage.

Ordering Information

Color	Standard	Black (-0)
Size selection	Always order the largest size that will shrink snugly over the component to be covered.	
Standard packaging	1.2-meter [4-foot] or 7.5-meter [25-foot] lengths. Nonstandard lengths are available upon request.	
Ordering description	See below.	

Part Numbering System

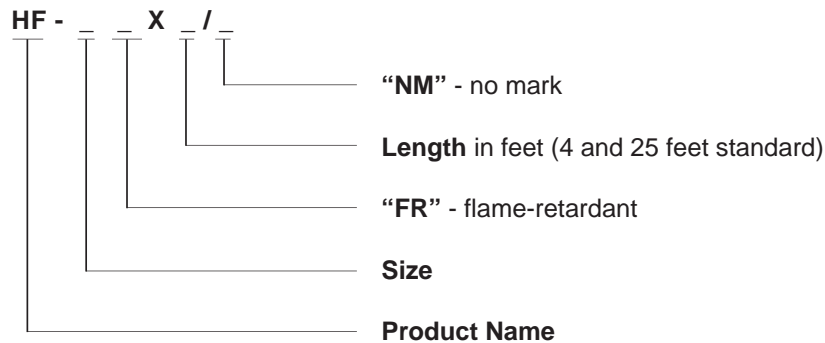

Example: HF-17FRX25/NM

High-Ratio,
Heat-Shrinkable Tubing

Product Facts

- Offers toughness and durability
- Provides excellent insulation and abrasion protection
- Is available in flame-retardant material.
- Shrinks to fit (5.6:1)
- FR callouts meet the flame-retardant material requirements of AMS-DTL-23053/15*
- HRHF and HRSR have the following agency approvals:
 - ABS (American Bureau of Shipping)
 - DNV (Det Norske Veritas)
 - Lloyd's (Lloyd's Register of Shipping)



HRHF/HRNF/HRSR



3 Heat-Shrinkable Tubing

Applications

High-ratio (HR) heat-shrinkable tubing, with expansion ratios as high as 5.6 to 1, is designed to accommodate large size differences between cables and cable connectors and backshells, thus simplifying repair of damaged cable. High-ratio tubing is available in semirigid flame-retardant (SR), standard (NF), or high-flex flame-retardant (HF) material and with or without factory-applied sealants

and adhesives. The waterproofing sealant provides environmental sealing and is watertight in wet and corrosive locations per USCG CGHQ-3774. The thermoplastic adhesive coating offers excellent strain relief and environmental sealing.

Installation

Minimum shrink temperature: 80°C [176°F]
 Minimum full recovery temperature: 121°C [250°F]
Operating Temperature Range
 -55°C to 90°C
 [-67°F to 194°F]

Specifications/Approvals

Series	Military	Agency	Raychem
HRSR	AMS-DTL-23053/15*	ABS, DNV, Lloyd's	RW-2013
HRHF	AMS-DTL-23053/15*	ABS, DNV, Lloyd's	RW-2013
HRNF	—	—	—

*Formerly MIL-I-23053/15 and MIL-DTL-23053/15.

Available in:	Americas	Europe	Asia Pacific
	■	■	■

Product Dimensions

HRHF/HRNF/HRSR (Continued)

Size†	Inside Diameter		Recovered Wall Thickness†† Nominal After Heating
	Minimum Expanded as Supplied	Maximum Recovered After Heating	
HR**060	15.24 [0.60]	3.81 [0.150]	1.52 [0.060]
HR**125	31.75 [1.25]	5.59 [0.220]	1.52 [0.060]
HR**175	44.45 [1.75]	8.00 [0.315]	2.41 [0.095]
HR**200	50.80 [2.00]	9.52 [0.375]	2.67 [0.105]
HR**250	63.50 [2.50]	12.70 [0.500]	3.05 [0.120]
HR**300	76.20 [3.00]	19.05 [0.750]	3.05 [0.120]
HR**400	101.60 [4.00]	22.86 [0.900]	3.56 [0.140]

†For ** substitute HF, NF or SR for material required. Add FR to end of number for flame-retardant material.

††Wall thickness will be less if tubing recovery is restricted during shrinkage.

Ordering Information

Color	Standard	Black (-0)
	Nonstandard	Clear (-X) available on request (not flame-retardant)
Size selection	Always order the largest size that will shrink snugly over the component to be covered. Other sizes are available upon request.	
Standard packaging	10-inch-maximum* lengths.	
Ordering description	See below.	

*Cutting tolerance is ± .125".

Part Numbering System – Military Approved Part Numbers

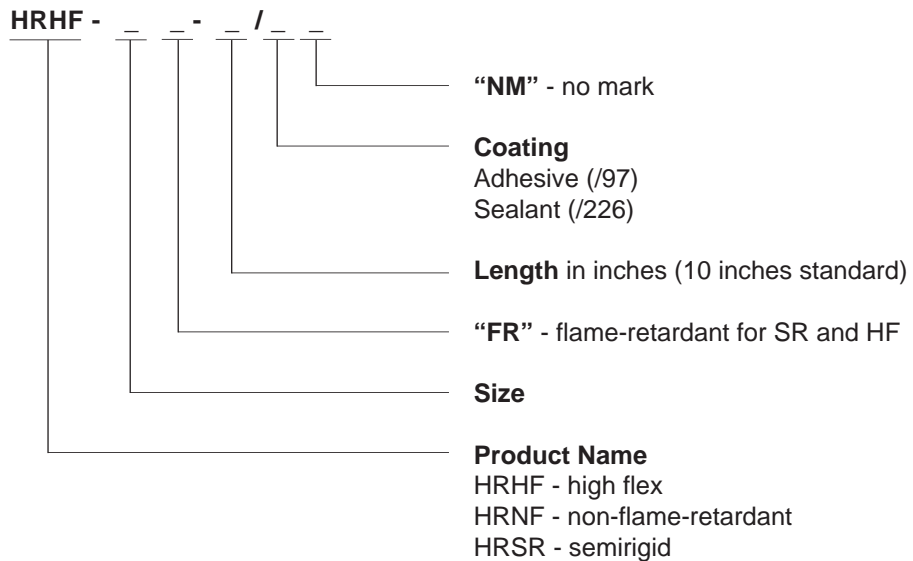

Example: HRHF-125FR-10/226-NM

Rugged, Heavy Wall,
Adhesive-Lined, Polyolefin
Heat-Shrinkable Tubing

Product Facts

- Withstands mechanical abuse for increased product reliability
- Highly resistant to impact and abrasion
- Provides high level of strain relief when installed on splices and joints
- Resistant to chemicals, moisture and oils
- Provides a complete moisture-proof seal preventing corrosion of underlying components

RHW



Applications

Rugged, heavy wall RHW tubing is specifically designed for insulating, protecting and sealing electrical connections and joints in low-voltage cables. It provides splice insulation thickness equal to or greater than standard wire insulation manufactured to common industry standards.

RHW is the ideal choice for applications where maximum reliability and product performance, and simplified installation are required. Because RHW is heat-shrinkable, a minimum number of sizes are needed to cover a wide range of cables and splice diameters.

Installation

Minimum shrink temperature: 110°C [230°F]
Minimum full recovery temperature: 125°C [257°F]

Operating Temperature Range

-55°C to 110°C
[-67°F to 230°F]

Specifications/Approvals

Series	UL** US	Raychem
RHW	File E115664	RHW SCD

**Sizes 9/3 through 70/21 only.

Available in:	Americas	Europe	Asia Pacific
	■	■	■

Product Dimensions

RHW (Continued)

Size	Inside Diameter		Recovered Wall Thickness**	
	Minimum Expanded as Supplied	Recovered After Heating	Nominal Jacket Wall	Nominal Adhesive Wall
9/3	9 [0.354]	3 [0.118]	2.0 [0.079]	0.25 [0.010]
13/4	13 [0.512]	4 [0.158]	2.4 [0.094]	0.30 [0.012]
20/6	20 [0.787]	6 [0.236]	2.5 [0.098]	0.35 [0.014]
33/8	33 [1.299]	8 [0.315]	3.2 [0.126]	0.35 [0.014]
43/12	43 [1.693]	12 [0.472]	4.3 [0.169]	0.40 [0.016]
51/16	51 [2.008]	16 [0.630]	4.5 [0.177]	0.40 [0.016]
70/21	70 [2.756]	21 [0.827]	4.4 [0.173]	0.40 [0.016]
85/25	85 [3.346]	25 [0.984]	4.3 [0.169]	0.40 [0.016]
105/30	105 [4.134]	30 [1.181]	4.3 [0.169]	0.45 [0.018]
130/36	130 [5.118]	36 [1.417]	4.3 [0.169]	0.45 [0.018]
160/50	160 [6.299]	50 [1.968]	4.3 [0.169]	0.45 [0.018]
180/50	180 [7.087]	50 [1.968]	4.3 [0.169]	0.50 [0.020]

**Wall thickness will be less if tubing recovery is restricted during shrinkage.

Ordering Information

Color	Standard	Black (-0) is available in all sizes Red (-2) is available in sizes 9/3, 13/4, 20/6 and 33/8
Size selection	Always order the largest size that will shrink snugly over the component to be covered. Special order sizes are available upon request.	
Standard packaging	1200mm lengths	
Marking	Tubing will be marked with the product name, size and batch number. Sizes 9/3 through 70/21 will also be marked with the UL Logo	
Ordering description	Specify product name, size, cut length, coating option and color (for example, RHW 20/6-1200/ADH-0 (ADH = Adhesive-lined, 0= Black, 2 = Red)	

Medium Wall, Polyolefin Heat-Shrinkable Tubing

Product Facts

- Withstands mechanical abuse for increased product reliability
- Highly resistant to impact and abrasion
- Installation is fast and easy
- Resistant to chemicals and moisture
- Adhesive-lined version provides a complete moisture-proof seal preventing corrosion of underlying components



RMW



3 Heat-Shrinkable Tubing

Applications

Medium wall, general purpose RMW tubing is specifically designed for use in a broad range of low-voltage applications. RMW is tough and flexible, making it particularly suited for the insulation and protection of cable joints as well as for cable repair. Uncoated RMW provides insulation and strain relief. Adhesive-lined RMW also provides an environmental seal.

RMW is the ideal choice for applications where maximum reliability and product performance, and simplified installation are required. Because RMW is heat-shrinkable, a minimum number of sizes are needed to cover a wide range of cables and splice diameters.

Installation

Minimum shrink temperature: 110°C [230°F]
 Minimum full recovery temperature: 125°C [257°F]

Operating Temperature Range

-55°C to 110°C
 [-67°F to 230°F]

Specifications/Approvals

Series	Raychem
RMW	RMW SCD

Available in:	Americas	Europe	Asia Pacific
	■	■	■

Product Dimensions

RMW (Continued)

Size	Inside Diameter		Recovered Wall Thickness**	
	Minimum Expanded as Supplied	Recovered After Heating	Nominal Jacket Wall	Nominal Adhesive Wall
10/3	10 [0.394]	3 [0.118]	1.0 [0.039]	0.25 [0.010]
16/5	16 [0.630]	5 [0.197]	1.4 [0.055]	0.30 [0.012]
25/8	25 [0.984]	8 [0.315]	2.0 [0.079]	0.35 [0.014]
35/12	35 [1.378]	12 [0.472]	2.0 [0.079]	0.35 [0.014]
50/16	50 [1.968]	16 [0.630]	2.0 [0.079]	0.35 [0.014]
63/19	63 [2.480]	19 [0.748]	2.4 [0.095]	0.40 [0.016]
75/22	75 [2.953]	22 [0.866]	2.7 [0.106]	0.40 [0.016]
85/25	85 [3.346]	25 [0.984]	2.8 [0.110]	0.40 [0.016]
95/29	95 [3.740]	29 [1.142]	3.1 [0.122]	0.45 [0.018]
115/34	115 [4.527]	34 [1.339]	3.1 [0.122]	0.45 [0.018]
140/42	140 [5.512]	42 [1.654]	3.1 [0.122]	0.45 [0.018]
160/50	160 [6.299]	50 [1.968]	3.2 [0.126]	0.50 [0.020]
180/60	180 [7.087]	60 [2.362]	3.2 [0.126]	0.50 [0.020]

**Wall thickness will be less if tubing recovery is restricted during shrinkage.

Ordering Information

Color	Standard	Black (-0)
Size selection	Always order the largest size that will shrink snugly over the component to be covered. Special order sizes are available upon request.	
Standard packaging	1200mm lengths	
Marking	Tubing will be marked with the product name, size and batch number.	
Ordering description	Specify product name, size, cut length, coating option and color (for example, RMW 25/8-1200/ADH-0 or RMW 75/22-1200/U-0 (ADH = Adhesive-lined, U = Uncoated, 0= Black)	

Self-Sealing,
Heat-Shrinkable Tubing

Product Facts

- Thick adhesive liner forms an effective barrier against fluids and moisture
- Thick-wall insulation, strain relief and abrasion protection
- No need for greases, tape, or epoxy
- Expansion ratios as high as 3:1
- Available in flame-retardant material
- SST has the following agency approvals:
 - ABS (American Bureau of Shipping)
 - DNV (Det Norske Veritas)
 - Lloyd's (Lloyd's Register of Shipping)



Specifications/Approvals

SST/SST-FR

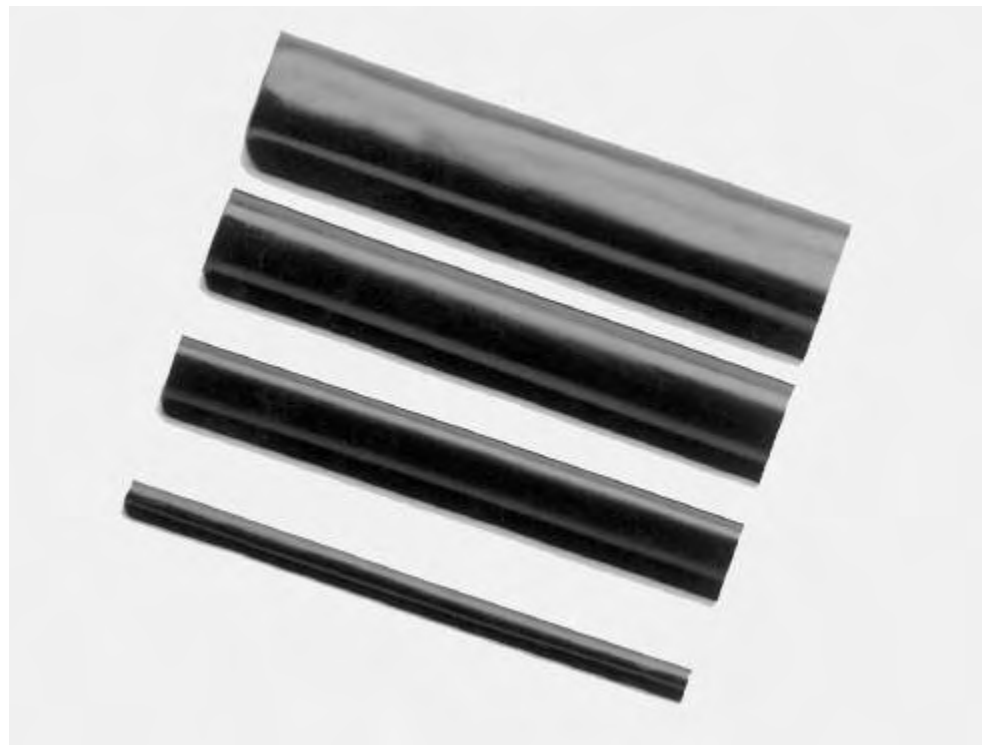

Applications

SST provides a simple, positive splice-sealing method that offers protection under adverse environmental conditions. Tubing supplied with standard sealant provides water sealing and environmental protection in wet or underground applications. The thermoplastic adhesive not only seals, but also provides mechanical strain relief. The polymer tubing has excellent insulating, abrasion-resistance, and strain-relief properties.

Installation

Minimum shrink temperature: 90°C [195°F]
Minimum full recovery temperature: 121°C [250°F]

Operating Temperature Range

-55°C to 90°C
[-67°F to 194°F]

Series	Military	Industry	Raychem
SST	—	—	RW- 2011
SST-FR	AMS-DTL-23053/15*, Classes 1 and 2	ASTM D 685, nonburning ASTM D 2863, oxygen index IPCEA S-19-81, cable insulation and jackets IEEE-383 Section 2.5 massive flame vertical tray ABS, DNV, Lloyd's Register	RW -2011

*Formerly MIL-I-23053/I5 and MIL-DTL-23053/15.

Available in:	Americas	Europe	Asia Pacific
	■	■	■

Product Dimensions
(inches)

SST/SST-FR (Continued)

Size†	Standard Nominal Length	Inside Diameter		Wall Thickness		Recommended Cable Range for 600-Volt Cable
		Minimum Expanded as Supplied	Maximum Recovered After Heating	Expanded	Nominal Wall After Heating††	
SST*-03	6, 30	0.300	0.100	0.025	0.060	18 through 14 AWG
SST*-04	6, 30	0.400	0.150	0.025	0.060	14 through 10 AWG
SST*-07M	6, 9, 12, 48	0.750	0.220	0.020	0.060	8 through 1 AWG
SST*-07	6, 9, 12, 48	0.750	0.220	0.030	0.095	8 through 1 AWG
SST*-11M	6, 9, 12, 48	1.100	0.375	0.030	0.105	2 through 4/0 AWG
SST*-11	6, 9, 12, 48	1.100	0.375	0.040	0.120	2 through 4/0 AWG
SST*-13M	6, 9, 12, 48	1.300	0.375	0.025	0.105	2 through 4/0 AWG
SST*-13	6, 9, 12, 48	1.300	0.375	0.035	0.120	2 through 4/0 AWG
SST*-15M	6, 9, 12, 48	1.500	0.500	0.035	0.120	2/0 AWG through 500 MCM
SST*-15	6, 9, 12, 48	1.500	0.500	0.050	0.140	2/0 AWG through 500 MCM
SST*-17M	6, 9, 12, 48	1.700	0.500	0.030	0.120	2/0 AWG through 500 MCM
SST*-17	6, 9, 12, 48	1.700	0.500	0.045	0.140	2/0 AWG through 500 MCM
SST*-20M	6, 9, 12, 48	2.000	0.750	0.040	0.120	350 MCM through 1000 MCM
SST*-20	6, 9, 12, 48	2.000	0.750	0.050	0.155	350 MCM through 1000 MCM
SST*-27	12, 18, 24, 48	2.700	0.900	0.050	0.155	500 MCM through 1250 MCM
SST*-30	12, 18, 24, 48	3.000	1.250	0.050	0.155	900 MCM through 1500 MCM
SST*-40	12, 18, 24, 48	4.000	1.750	0.050	0.155	1500 MCM through 2500 MCM
SST*-45	12, 18, 24, 48	4.500	1.750	0.050	0.155	1500 MCM through 2500 MCM

†In place of asterisk* substitute length of tubing to be ordered. For example, SST*-11, as the third column indicates, comes in 6-, 9-, 12- and 48-inch lengths, so a 9-inch cut piece of SST tubing would be SST 9-11.
 The suffix M = medium-wall tubing. ††Wall thickness will be less if tubing recovery is restricted during shrinkage.

Ordering Information

Color	Standard	Black (-0)
Size selection	Always order the largest size that will shrink snugly over the component to be covered. Special order sizes are available upon request.	
Standard packaging	See Product Dimensions table.	
Ordering description	Specify product name, cut length, size and color (for example, SST 48-07/FR/RS).	

Part Numbering System

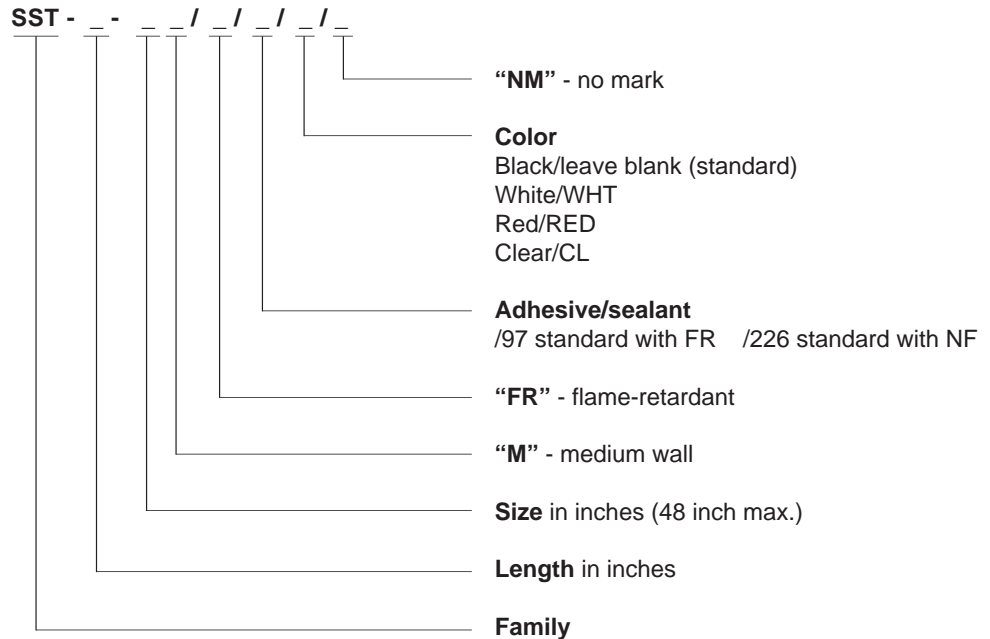

Example: SST-48-07M/FR/97/NM

Heat-Shrinkable, Flexible,
Chemical and Abrasion
Resistant Tubing

Product Facts

- Flame-retardant
- System 25 tubing
- Shrink ratio 2:1



Specifications/Approvals

DR-25



Applications

Specially formulated for optimum high temperature fluid resistance, and long term heat resistance. Resistant to aviation and diesel fuels, hydraulic fluids and lubricating oils.

Particularly suitable as a jacketing material for military ground vehicle cables and harnesses. It is also ideally suited for the demands of motorsport cable harnesses. When used in conjunction with System 25 heat-shrinkable molded shapes and S1125 high performance adhesive, these products provide a complete cable harness system.

Installation

Minimum shrink temperature: 150°C [302°F]
Minimum full recovery temperature: 175°C [347°F]

Operating Temperature Range

-75°C to 150°C
[-103°F to 302°F]
(per VG 95343 Part 5 Type D)

Series	Military	Raychem
DR-25	AMS-DTL-23053/16* VG95343 Part 5 Type D VDE 0341/Pt 9005 Def Stan 59-97 Issue 3 Type 6B BS 4G-198 Part 3 10A	RT-1116 RK-6008/1

*Formerly MIL-I-23053/16 and MIL-DTL-23053/16.

Available in:	Americas	Europe	Asia Pacific
	■	■	■

Product Dimensions

DR-25 (Continued)

Size	Inside Diameter		Recovered Wall Thickness** After Heating
	Minimum Expanded as Supplied	Maximum Recovered After Heating	
1/8	3.2 [0.125]	1.6 [0.062]	0.76 ± 0.15 [0.030 ± 0.006]
3/16	4.8 [0.187]	2.4 [0.093]	0.84 ± 0.15 [0.033 ± 0.006]
1/4	6.4 [0.250]	3.2 [0.125]	0.89 ± 0.15 [0.035 ± 0.006]
3/8	9.5 [0.375]	4.8 [0.187]	1.02 ± 0.20 [0.040 ± 0.008]
1/2	12.7 [0.500]	6.4 [0.250]	1.22 ± 0.20 [0.048 ± 0.008]
3/4	19.0 [0.748]	9.5 [0.375]	1.45 ± 0.28 [0.057 ± 0.011]
1	25.4 [1.000]	12.7 [0.500]	1.78 ± 0.28 [0.070 ± 0.011]
1 1/2	38.0 [1.500]	19.0 [0.748]	2.41 ± 0.41 [0.095 ± 0.016]
2	51.0 [2.000]	25.4 [1.000]	2.79 ± 0.41 [0.110 ± 0.016]
3	76.0 [3.000]	38.0 [1.500]	3.18 ± 0.50 [0.125 ± 0.020]

**Wall thickness will be less if tubing recovery is restricted during shrinkage.

Ordering Information

Color	Standard	Black (-0)
Size selection	Always order the largest size that will shrink snugly over the component to be covered. Special order sizes are available upon request.	
Standard packaging	On spools.	
Ordering description***	Specify product name, size and color (for example, DR-25 1/8-0)	

***Europe only. For supply to Def Stan and BS add -DS or -BS to ordering description.

High-Shrink-Ratio,
Adhesive-Lined, Semirigid
Polyolefin Caps

Product Facts

- 4:1 shrink ratio allows a few sizes to cover a wide range of splice and component diameters
- Mechanically tough jacket provides strain relief and abrasion protection
- Thick adhesive liner forms an effective barrier against fluids and moisture and performs well at an extended temperature range



ES Caps



Applications

Specially designed to provide mechanical and environmental protection of stub splices in electrical harnesses. Clear caps allow see-through inspection; black caps are flame-retardant.

Installation

Minimum shrink temperature: 100°C [212°F]
Minimum full recovery temperature: 135°C [275°F]

Operating Temperature Range

-40°C to 105°C
[-40°F to 221°F]

Specifications/Approvals

Series	UL 	Raychem
ES Caps	E85381 600 V, 125°C	RW-3006

Available in:	Americas	Europe	Asia Pacific
	■	■	■

Product Dimensions

ES Caps (Continued)

Part Number	Inside Diameter (Including Core)			Recovered Wall Thickness**		
	Standard Length* as Supplied (Millimeters)	Minimum Expanded as supplied	Maximum Recovered After Heating	Minimum Total Wall After Heating	Minimum Jacket Wall After Heating	Minimum Adhesive Wall After Heating
ES Cap-No.1	30, 35	5.72 [0.225]	1.27 [0.050]	1.20 [0.047]	0.64 [0.025]	0.56 [0.022]
ES Cap-No.2	30, 35	7.44 [0.293]	1.65 [0.065]	1.52 [0.060]	0.76 [0.030]	0.76 [0.030]
ES Cap-No.3	40, 50	10.85 [0.427]	2.41 [0.095]	1.91 [0.075]	0.89 [0.035]	1.02 [0.040]

*Other cap lengths available upon request.

**Wall thickness will be less if cap recovery is restricted during shrinkage.

Ordering Information

Color	Standard Black (-0), clear (-X)
Size selection	Always order the largest size that will shrink snugly over the component to be covered. Other cap lengths available on request.
Standard packaging	In pieces.
Marking	Caps will be marked with their numbered size (such as ES-1, ES-2, or ES-3).
Ordering description	Specify product name, size, color, and length (for example, ES CAP-NO.2-X-35MM).

Helical Convolex Tubing with a High Crush Resistance

Product Facts

- Highly flame-retardant
- Highly flexible and fluid resistant
- Not heat-shrinkable
- High crush resistance
- System 300 conduit tubing

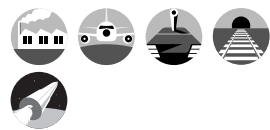

HCTE

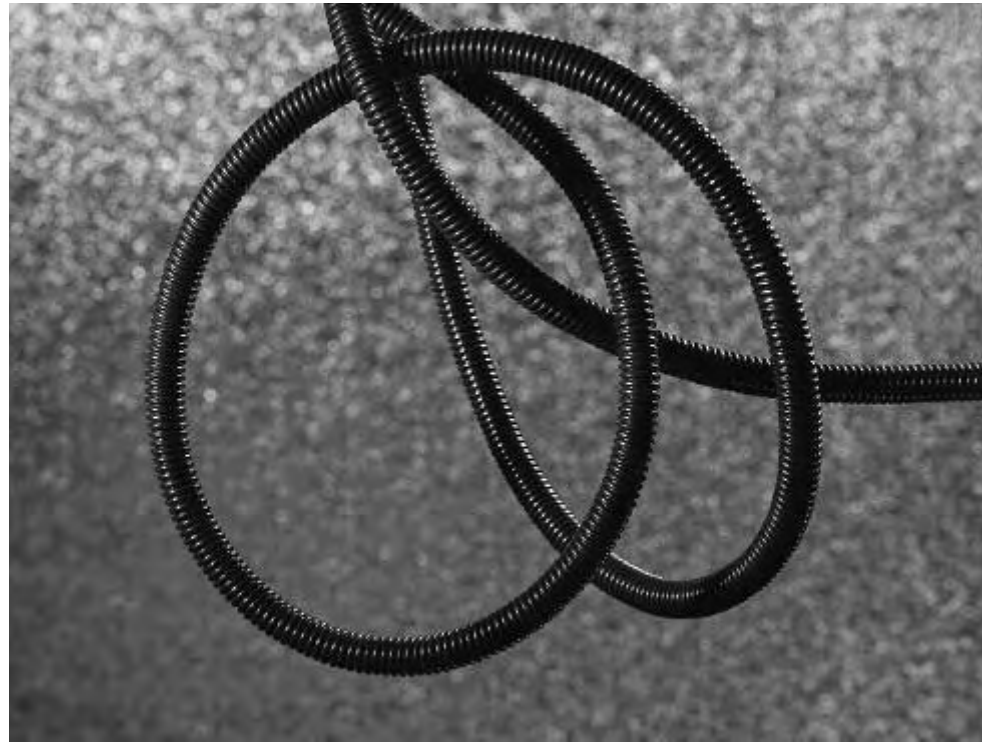

Applications

Used as a conduit to provide mechanical protection for electrical wiring systems in applications requiring flexibility, high-temperature performance and good resistance to a variety of fluids. Widely used in the military and commercial aerospace industries. Can be used in conjunction with other Raychem components to form an integrated harnessing system.

Installation

It is recommended that no more than 70% of the internal area ("fill factor") of the HCTE conduit be occupied by wires in any application.

Operating Temperature Range

-55°C to 200°C
[-67°F to 392°F]

Specifications/Approvals

Series	Military	Raychem
HCTE	VG 96936 Part 6	RT-1162

Available in:	Americas	Europe	Asia Pacific
	■	■	■

Product Dimensions

HCTE (Continued)

Size	Inside Diameter Minimum	Outside Diameter Maximum	Maximum Wall Thickness
0187	4.60 [0.181]	8.10 [0.320]	0.46 [0.018]
0281	6.90 [0.273]	10.50 [0.414]	0.46 [0.018]
0312	7.70 [0.306]	11.80 [0.450]	0.46 [0.018]
0375	9.20 [0.364]	12.90 [0.510]	0.46 [0.018]
0437	10.80 [0.427]	14.50 [0.571]	0.46 [0.018]
0500	12.30 [0.485]	16.50 [0.650]	0.58 [0.023]
0625	15.40 [0.608]	19.50 [0.770]	0.58 [0.023]
0750	17.90 [0.730]	23.60 [0.930]	0.58 [0.023]
0875	21.80 [0.860]	27.20 [1.073]	0.58 [0.023]
1000	24.70 [0.975]	31.10 [1.226]	0.58 [0.023]
1250	30.70 [1.210]	35.30 [1.539]	0.58 [0.023]
1500	36.50 [1.437]	46.50 [1.832]	0.58 [0.023]
1625	39.60 [1.562]	50.17 [1.975]	0.58 [0.023]
1750	42.67 [1.688]	52.88 [2.082]	0.58 [0.023]
2000	49.20 [1.937]	59.23 [2.332]	0.58 [0.023]

Ordering Information

Color	Standard	Black (-0)
Size selection	Always order a conduit size that will ensure that a "fill factor" of 70% is not exceeded.	
Standard packaging	On spools.	
Ordering description	Specify product name, size and color (for example, HCTE-0187-0).	

Electronics

HFT5000

Heat-Shrinkable Fabric Tubing

Product Facts

- Highly flexible woven fabric tubing
- Polyethylene/polyester construction for excellent abrasion resistance
- Halogen free
- Heat-shrinkable to grip substrates tightly without additional fixing
- 2:1 shrink ratio for easy installation onto different substrate diameters and sizes
- Highly flexible woven fabric construction for easy, compliant installation onto awkward substrates such as bent hoses
- Outstanding abrasion resistance over a wide temperature range
- Easily cut with standard industrial cutting equipment
- Resistant to harsh environments
- Multifilament construction that ensures soft, safe handling
- Low shrink temperature for safe installation onto heat sensitive substrates

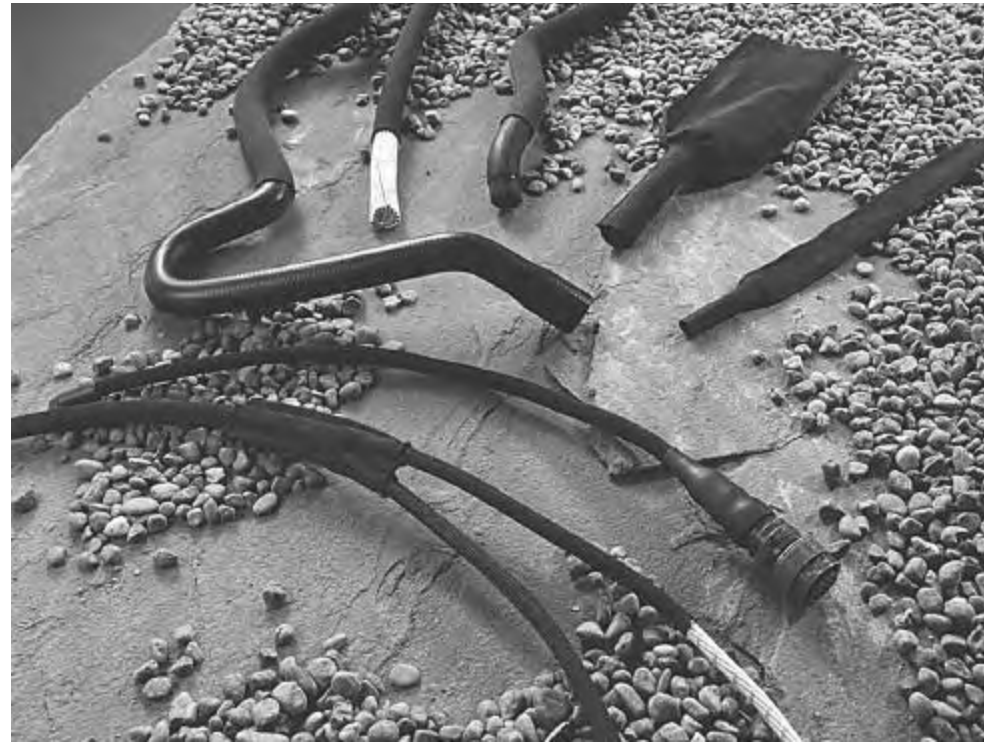

Applications

Designed primarily to provide mechanical abrasion protection for components such as rubber hoses, plastic pipes, and harness wiring bundles. Also suitable for other applications, such as noise and rattle suppression.

The woven construction makes HFT5000 extremely flexible and resistant to trapping water, heat and humidity. Provides outstanding abrasion, chafing and cutting protection, even at high temperatures.

Installation

Minimum shrink temperature: 80°C [176°F]
 Minimum full recovery temperature: 110°C [230°F]
 Maximum storage temperature: 60°C [140°F]

Operating Temperature Range

3000 hours: -40°C to 125°C [-40°F to 257°F]
 1000 hours: -40°C to 150°C [-40°F to 302°F]

Specifications/Approvals

Series	UL 	Raychem
HFT5000	E199379 Rated 135°C	RW-2060

Available in:	Americas	Europe	Asia Pacific
	■	■	■

HFT5000 (Continued)

Product Dimensions

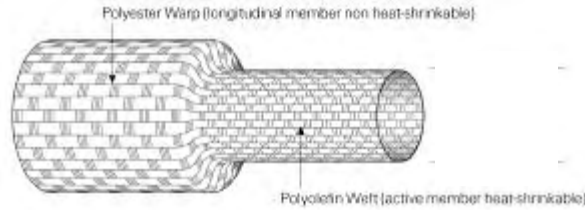

Size	Inside Diameter	
	Minimum Expanded as Supplied	Maximum Recovered After Heating
Standard		
12/6	12 [0.47]	6 [0.24]
20/10	20 [0.79]	10 [0.39]
30/15	30 [1.18]	15 [0.59]
40/20	40 [1.57]	20 [0.79]
50/25	50 [1.97]	25 [0.98]
60/30	60 [2.36]	30 [1.18]
70/35	70 [2.76]	35 [1.38]
Nonstandard High Volume		
25/12	25 [0.98]	12 [0.47]
34/17	34 [1.34]	17 [0.67]
80/40	80 [3.15]	40 [1.57]

Ordering Information

Color	Standard	Black (-0)
Standard packaging	On spools.	
Ordering description	Specify product name, size and color (for example, HFT5000-12/6-0)	

Small-Diameter,
High-Shrink-Ratio Tubing

Product Facts

- Small diameter
- High shrink ratio
- Thin wall
- Polyolefin and fluoropolymer materials



MicroFit



Applications

The MicroFit family of small-diameter, high-shrink-ratio tubing is ideal for electrical insulation, mechanical protection, and strain relief in smaller, more compact medical devices and commercial electronics products. Offered in a variety of materials. The RW-175 version of MicroFit tubing is suitable for use in space applications.

Installation

Minimum full recovery temperature:
 175°C [347°F] (MT1000)
 140°C [284°F] (MT2000)
 175°C [347°F] (RW-175)

Operating Temperature Range

MT1000: -55°C to 175°C
 [-67°F to 347°F]
 MT2000: -40°C to 105°C
 [-40°F to 221°F]
 RW-175: -55°C to 175°C
 [-67°F to 347°F]

Specifications/Approvals

Series	Material	Master File Number	Raychem
Altera MicroFit	USP Class VI (MT1000)	MAF-444 (MT1000)	Altera MicroFit SCD
	USP Class VI (MT2000)	MAF-727 (MT2000)	
RW-175 MicroFit	—	—	RW-175 MicroFit SCD

Available in:	Americas	Europe	Asia Pacific
	■	■	■

Product Dimensions

MicroFit (Continued)

Size	Inside Diameter		Wall Thickness	
	Minimum Expanded as Supplied	Maximum Recovered After Heating	As Supplied (Nominal)	Recovered*** (Maximum)
MFT*-No. 1-**	0.356 [0.014]	0.178 [0.007]	0.076 [0.003]	0.127 [0.005]
MFT*-No. 2-**	0.610 [0.024]	0.305 [0.012]	0.064 [0.0025]	0.152 [0.006]
MFT*-No. 33-**	1.143 [0.045]	0.432 [0.017]	0.064 [0.0025]	0.178 [0.007]
MFT*-No. 65-**	0.635 [0.025]	0.254 [0.010]	0.127 [0.005]	0.330 [0.013]

*Replace single asterisk with material type: MT1000, MT2000, or RW-175.

**Replace double asterisk with color-code number.

***Wall thickness will be less if tubing recovery is restricted during shrinkage.

Ordering Information

	MT1000	MT2000	RW-175
Color	Standard	Translucent (-X)	Black (-0), clear (-X)
	Nonstandard	Black (-0)	White (-9), red (-2), yellow (-4), blue (-6), orange (-3)
Size selection	Always order the largest size that will shrink snugly over the component to be covered.		
Standard packaging	On plastic spools****		
Ordering description	Specify product name, material, size and color (for example, MFT-MT2000-NO.1-0).		

****MFT-MT1000 and MFT-MT2000 are double bagged.

Altera Medical-Grade,
USP Class VI,
High-Temperature,
Semirigid,
Fluoropolymer Tubing

Product Facts

- 2:1 shrink ratio
- Tough, semirigid, very-thin-wall insulation
- Excellent resistance to a variety of fluids
- Optional inner adhesive lining in sizes 1/8" and larger (MT1000A)
- USP Class VI material, no heavy metals
- Double-bagged packaging
- Compatibility with gamma, ETO, steam, and dry-heat sterilization



MT1000

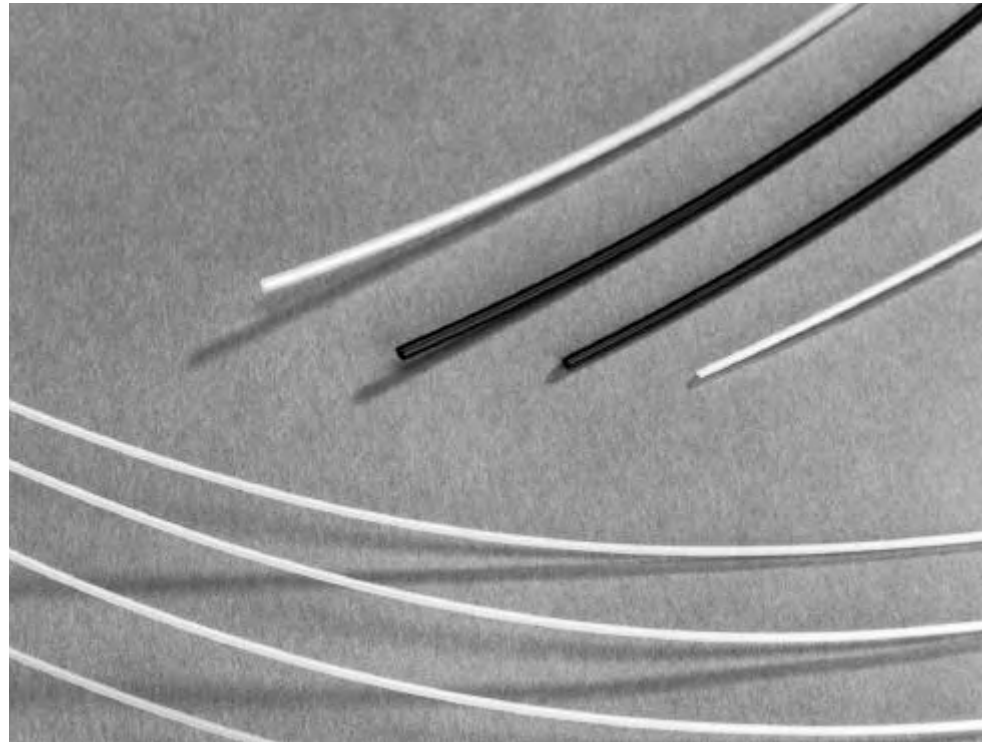

Applications

Ideal for electrical insulation and strain relief of components that are exposed to high temperatures - either during operation or during sterilization.

Thin-wall construction is well suited for applications with clearance constraints.

Installation

Minimum shrink temperature: 155°C [311°F]
Minimum full recovery temperature: 175°C [347°F]

Operating Temperature Range

-55°C to 175°C
[-67°F to 347°F]

Specifications/Approvals

Series	Material	Master File Number	Raychem
MT1000	USP Class VI	MAF-444	MT1000 SCD
MT1000A	USP Class VI	MAF-798	MT1000A SCD

Available in:	Americas	Europe	Asia Pacific
	■	■	■

Product Dimensions

MT1000 (Continued)

Size	Inside Diameter		Recovered Wall Thickness** After Heating
	Minimum Expanded as Supplied	Maximum Recovered After Heating	
3/64**	1.17 [0.046]	0.58 [0.023]	0.25 ± 0.05 [0.010 ± 0.002]
1/16	1.6 [0.063]	0.8 [0.031]	0.25 ± 0.05 [0.010 ± 0.002]
3/32	2.4 [0.093]	1.2 [0.046]	0.25 ± 0.05 [0.010 ± 0.002]
1/8	3.2 [0.125]	1.6 [0.062]	0.25 ± 0.05 [0.010 ± 0.002]
3/16	4.7 [0.187]	2.4 [0.093]	0.25 ± 0.05 [0.010 ± 0.002]
1/4	6.4 [0.250]	3.2 [0.125]	0.33 ± 0.05 [0.013 ± 0.002]
3/8	9.5 [0.375]	4.7 [0.187]	0.33 ± 0.05 [0.013 ± 0.002]
1/2	12.7 [0.500]	6.4 [0.250]	0.33 ± 0.05 [0.013 ± 0.002]
3/4**	19.1 [0.750]	9.5 [0.375]	0.43 ± 0.08 [0.017 ± 0.003]
1**	25.4 [1.000]	12.7 [0.500]	0.48 ± 0.08 [0.019 ± 0.003]

*Wall thickness will be less if tubing recovery is restricted during shrinkage.

**Nonstandard size; available by special order only.

Ordering Information

Color	Standard	Translucent (-X)
	Nonstandard	Black (-0)
Size selection	Always order the largest size that will shrink snugly over the component to be covered. Special order sizes are available upon request.	
Standard packaging	In 1.2-meter (4-foot) lengths, double bagged.	
Ordering description	Specify product name, size and color (for example, MT1000-1/8-X). Specify MT1000A for adhesive-lined constructions (special order).	

Altera Medical-Grade, USP Class VI, Lubricious, Thin-Wall, Polyolefin Tubing

Product Facts

- 2.5:1 shrink ratio
- Lubricity comparable to FEP
- Excellent electrical insulation properties
- Can be manufactured with a very thin wall
- Optional inner adhesive lining in sizes 3.0 and larger (MT2000A)
- USP Class VI material, no heavy metals
- Plastic spools and double-bagged packaging
- Compatibility with gamma and ETO sterilization



MT2000



Applications

Especially suitable for medical applications requiring lubricity, flexibility, and excellent electrical insulation performance. A cost-effective alternative to FEP (fluorinated ethylene-propylene) while maintaining performance after gamma sterilization.

Installation

Minimum shrink temperature: 110°C [230°F]
 Minimum full recovery temperature: 140°C [284°F]

Operating Temperature Range

-40°C to 105°C
 [-40°F to 221°F]

Specifications/Approvals

Series	Material	Master File Number	Raychem
MT2000	USP Class VI	MAF-727	MT2000 SCD
MT2000A	USP Class VI	MAF-799	MT2000A SCD

Available in:	Americas	Europe	Asia Pacific
	■	■	■

Product Dimensions

MT2000 (Continued)

Size	Inside Diameter		Wall Thickness	
	Minimum Expanded as Supplied	Maximum Recovered After Heating	As Supplied (Nominal)	Recovered* After Heating
1.0	1.0 [0.040]	0.45 [0.018]	0.12 [0.005]	0.25 ± 0.05 [0.010 ± 0.002]
2.0	2.0 [0.080]	0.80 [0.032]	0.12 [0.005]	0.25 ± 0.05 [0.010 ± 0.002]
3.0	3.0 [0.120]	1.20 [0.048]	0.12 [0.005]	0.25 ± 0.05 [0.010 ± 0.002]
6.0	6.0 [0.240]	2.40 [0.096]	0.12 [0.005]	0.25 ± 0.05 [0.010 ± 0.002]
10.0	10.0 [0.400]	4.00 [0.160]	0.15 [0.006]	0.36 ± 0.05 [0.014 ± 0.002]

*Wall thickness will be less if tubing recovery is restricted during shrinkage.

Ordering Information

Color	Standard	Black (-0), clear (-X)
	Nonstandard	White (-9), red (-2), blue (-6), yellow (-4), orange (-3)
Size selection	Always order the largest size that will shrink snugly over the component to be covered. Special order sizes are available upon request.	
Standard packaging	On plastic spools, double-bagged.	
Ordering description	Specify product name, size and color (for example, MT2000-3.0-0). Specify MT2000A for adhesive-lined constructions (special order).	

Altera Medical-Grade,
USP Class VI,
High-Temperature,
Flexible, Fluoropolymer
Tubing

Product Facts

- 2:1 shrink ratio
- Tough, flexible, very-thin-wall insulation
- Excellent resistance to a variety of fluids
- USP Class VI material, no heavy metals
- Plastic spools and double-bagged packaging
- Compatibility with steam (limited cycles), gamma, ETO, and dry-heat sterilization



MT3000

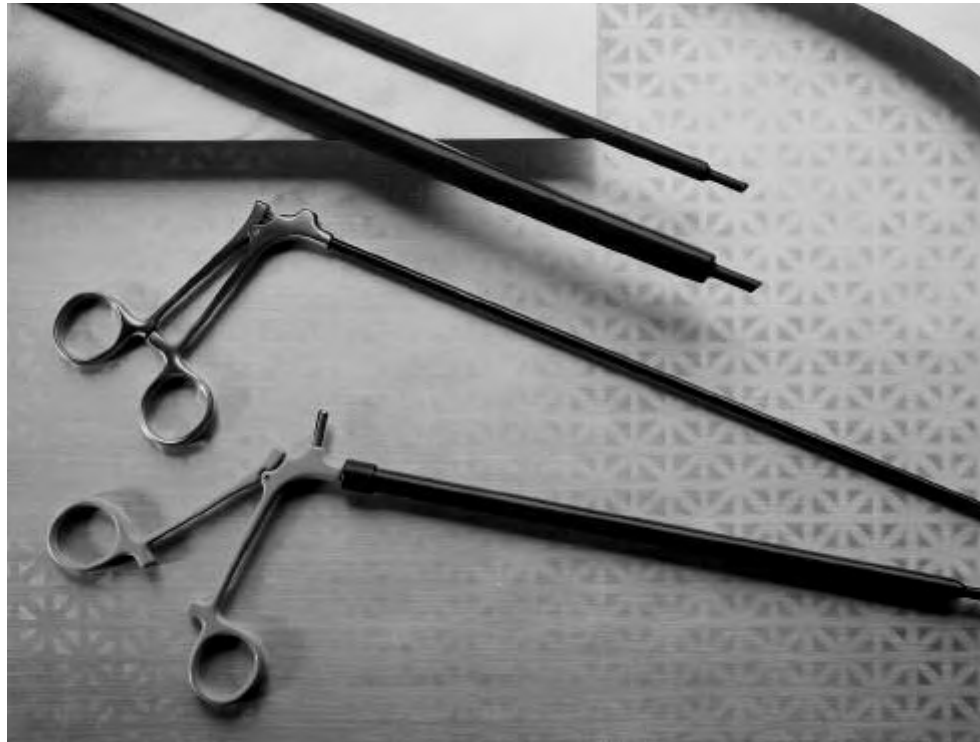

Applications

Used for electrical insulation and strain relief of components that are exposed to high temperatures - either during operation or during sterilization. Exceptional flexibility and thin-wall construction are well-suited for applications where pliancy coupled with small overall bundle size is desired.

Installation

Minimum shrink temperature: 110°C [230°F]
Minimum full recovery temperature: 150°C [302°F]

Operating Temperature Range

-55°C to 150°C
[-67°F to 302°F]

Specifications/Approvals

Series	Material	Master File Number	Raychem
MT3000	USP Class VI	MAF-472	MT3000 SCD

Available in:	Americas	Europe	Asia Pacific
	■	■	■

Product Dimensions

MT3000 (Continued)

Size	Inside Diameter		Recovered Wall Thickness* After Heating
	Minimum Expanded as Supplied	Maximum Recovered After Heating	
3/64**	1.17 [0.046]	0.58 [0.023]	0.25 ± 0.05 [0.010 ± 0.002]
1/16	1.6 [0.063]	0.8 [0.031]	0.25 ± 0.05 [0.010 ± 0.002]
3/32	2.4 [0.093]	1.2 [0.046]	0.25 ± 0.05 [0.010 ± 0.002]
1/8	3.2 [0.125]	1.6 [0.062]	0.25 ± 0.05 [0.010 ± 0.002]
3/16	4.7 [0.187]	2.4 [0.093]	0.25 ± 0.05 [0.010 ± 0.002]
1/4	6.4 [0.250]	3.2 [0.125]	0.30 ± 0.05 [0.012 ± 0.002]
3/8	9.5 [0.375]	4.7 [0.187]	0.30 ± 0.05 [0.012 ± 0.002]
1/2	12.7 [0.500]	6.4 [0.250]	0.30 ± 0.05 [0.012 ± 0.002]
3/4**	19.1 [0.750]	9.5 [0.375]	0.43 ± 0.08 [0.017 ± 0.003]
1**	25.4 [1.000]	12.7 [0.500]	0.48 ± 0.08 [0.019 ± 0.003]

*Wall thickness will be less if tubing recovery is restricted during shrinkage.

**Nonstandard size; available by special order only.

Ordering Information

Color	Standard	Black (-0)
	Nonstandard	White (-9)
Size selection	Always order the largest size that will shrink snugly over the component to be covered. Special order sizes are available upon request.	
Standard packaging	On plastic spools, double-bagged.	
Ordering description	Specify product name, size and color (for example, MT3000 1/4-0).	

Altera Medical-Grade,
USP Class VI, Flexible,
Polyolefin Tubing

Product Facts

- 2:1 shrink ratio
- Flexibility; variety of colors
- Excellent electrical insulation properties
- Inner adhesive lining optional in sizes 1/8" and larger (MT5000A)
- USP Class VI material, no heavy metals
- Plastic spools and double-bagged packaging
- Compatibility with gamma and ETO sterilization



MT5000



Applications

Especially suitable for applications requiring excellent electrical insulation performance and resistance to abrasion and harmful solvents such as electrosurgical instruments. Also used for strain relief, color coding, and identification of many medical components and devices.

Installation

Minimum shrink temperature: 90°C [194°F]
Minimum full recovery temperature: 110°C [230°F]

Operating Temperature Range

-70°C to 105°C
[-94°F to 221°F]

Specifications/Approvals

Series	Material	Master file number	Raychem
MT5000	USP Class VI	MAF-469	MT5000 SCD
MT5000A	USP Class VI	MAF-800	MT5000A SCD

Available in:	Americas	Europe	Asia Pacific
	■	■	■

Product Dimensions

MT5000 (Continued)

Size	Inside Diameter		Recovered Wall Thickness* After Heating
	Minimum Expanded as Supplied	Maximum Recovered After Heating	
3/64**	1.17 [0.046]	0.58 [0.023]	0.40 ± 0.08 [0.016 ± 0.003]
1/16	1.6 [0.063]	0.8 [0.031]	0.43 ± 0.08 [0.017 ± 0.003]
3/32	2.4 [0.093]	1.2 [0.046]	0.51 ± 0.08 [0.020 ± 0.003]
1/8	3.2 [0.125]	1.6 [0.062]	0.51 ± 0.08 [0.020 ± 0.003]
3/16	4.8 [0.187]	2.4 [0.093]	0.51 ± 0.08 [0.020 ± 0.003]
1/4	6.4 [0.250]	3.2 [0.125]	0.64 ± 0.08 [0.025 ± 0.003]
3/8	9.5 [0.375]	4.8 [0.187]	0.64 ± 0.08 [0.025 ± 0.003]
1/2	12.7 [0.500]	6.4 [0.250]	0.64 ± 0.08 [0.025 ± 0.003]
3/4**	19.1 [0.750]	9.5 [0.375]	0.76 ± 0.08 [0.030 ± 0.003]
1**	25.4 [1.000]	12.7 [0.500]	0.89 ± 0.12 [0.035 ± 0.005]

*Wall thickness will be less if tubing recovery is restricted during shrinkage.

**Nonstandard size; available by special order only.

Ordering Information

Color	Standard	Black (-0), clear (-X), and blue (-6)
	Nonstandard	White (-9), red (-2), yellow (-4)
Size selection	Always order the largest size that will shrink snugly over the component to be covered. Special order sizes are available upon request.	
Standard packaging	On plastic spools, double-bagged.	
Ordering description	Specify product name, size and color (for example, MT5000-1/4-0). Specify MT5000A for adhesive-lined constructions (special order).	

Flexible, General Purpose Modified Elastomeric Tubing

Product Facts

- Remains flexible at temperatures as low as -55°C [-67°F]
- Offers good resistance to abrasion and physical abuse while providing the flexibility and strain relief needed in general-purpose harnessing applications
- Resistant to most common fluids and solvents



NT



3 Heat-Shrinkable Tubing

Applications

Widely used for insulation, strain relief, and abrasion protection on cable harnesses and wire bundles in the commercial electronics industries where a reliable general-purpose tubing is needed. Suitable for applications requiring some exposure to common fluids and solvents.



Installation

Minimum shrink temperature: 90°C [194°F]
 Minimum full recovery temperature: 135°C [275°F]

Operating Temperature Range

-55°C to 90°C [-67°F to 194°F]

Specifications/Approvals

Series	UL 	CSA 	Raychem
NT	UL E35586 600V, 90°C	CSA LR31929 600V, 90°C	RT-510

Available in:	Americas	Europe	Asia Pacific
	■	■	■

Product Dimensions

NT (Continued)

Size	Inside Diameter		Recovered Wall Thickness** After Heating
	Minimum Expanded as Supplied	Maximum Recovered After Heating	
1/8	3.2 [0.125]	1.6 [0.061]	0.69 ± 0.20 [0.027 ± 0.008]
3/16	4.8 [0.187]	2.5 [0.100]	0.84 ± 0.25 [0.033 ± 0.010]
1/4	6.4 [0.250]	3.6 [0.143]	0.89 ± 0.25 [0.035 ± 0.010]
3/8	9.5 [0.375]	5.4 [0.211]	1.01 ± 0.25 [0.040 ± 0.010]
1/2	12.7 [0.500]	7.3 [0.286]	1.21 ± 0.38 [0.048 ± 0.015]
5/8	15.9 [0.625]	9.1 [0.357]	1.32 ± 0.38 [0.052 ± 0.015]
3/4	19.1 [0.750]	10.9 [0.428]	1.44 ± 0.38 [0.057 ± 0.015]
7/8	22.2 [0.875]	12.7 [0.500]	1.65 ± 0.38 [0.065 ± 0.015]
1	25.4 [1.000]	14.5 [0.570]	1.77 ± 0.51 [0.070 ± 0.020]
1 1/4	31.8 [1.250]	18.1 [0.714]	2.20 ± 0.51 [0.087 ± 0.020]
1 1/2	38.1 [1.500]	21.8 [0.857]	2.41 ± 0.51 [0.095 ± 0.020]
1 3/4	44.5 [1.750]	25.4 [1.000]	2.71 ± 0.51 [0.107 ± 0.020]
2	50.8 [2.000]	29.0 [1.140]	2.79 ± 0.51 [0.110 ± 0.020]
3	76.2 [3.000]	43.4 [1.710]	3.17 ± 0.51 [0.125 ± 0.020]
4	101.6 [4.000]	57.9 [2.280]	3.55 ± 0.51 [0.140 ± 0.020]

**Wall thickness will be less if tubing recovery is restricted during shrinkage.

Ordering Information

Color	Standard	Black (-0)
Size selection	Always order the largest size that will shrink snugly over the component to be covered. Special order sizes are available upon request.	
Standard packaging	On spools.	
Ordering description	Specify product name, size and color (for example, NT 1/4-0).	

Flexible, Rugged,
Modified Elastomeric
Tubing

Product Facts

- Remains flexible at temperatures as low as -70°C [-94°F] without cracking
- Withstands heat shock at 200°C [392°F] without dripping, flowing or cracking
- Offers outstanding resistance to abrasion and physical abuse while providing flexibility and strain relief needed in rugged harnessing applications
- Resistant to most fluids and solvents, including aviation and ground vehicle fuels, lubricating oil, and hydraulic fluids
- Meets the stringent requirements of SAE-AMS-DTL-23053/1, Classes 1 and 2



NT-MIL



3 Heat-Shrinkable Tubing

Applications

Widely used for insulation, strain relief and abrasion protection on cable harnesses and wire bundles in the military and aerospace industries where a reliable rugged tubing is needed. Especially suitable for applications requiring exposure to common fluids and solvents.

Installation

Minimum shrink temperature: 90°C [194°F]
Minimum full recovery temperature: 135°C [275°F]

Operating Temperature Range

-70°C to 121°C
[-94°F to 250°F]

Specifications/Approvals

Series	Military	Raychem
NT-MIL	AMS-DTL-23053/1*, Classes 1 & 2	RW-3030

*Formerly MIL-I-23053/1 and MIL-DTL-23053/1

Available in:	Americas	Europe	Asia Pacific
	■	■	■

Product Dimensions

NT-MIL (Continued)

Size	Inside Diameter		Recovered Wall Thickness* After Heating
	Minimum Expanded as Supplied	Maximum Recovered After Heating	
1/8	3.2 [0.125]	1.6 [0.061]	0.69 ± 0.20 [0.027 ± 0.008]
3/16	4.8 [0.187]	2.5 [0.100]	0.84 ± 0.25 [0.033 ± 0.010]
1/4	6.4 [0.250]	3.6 [0.143]	0.89 ± 0.25 [0.035 ± 0.010]
3/8	9.5 [0.375]	5.4 [0.211]	1.01 ± 0.25 [0.040 ± 0.010]
1/2	12.7 [0.500]	7.3 [0.286]	1.21 ± 0.38 [0.048 ± 0.015]
5/8	15.9 [0.625]	9.1 [0.357]	1.32 ± 0.38 [0.052 ± 0.015]
3/4	19.1 [0.750]	10.9 [0.428]	1.44 ± 0.38 [0.057 ± 0.015]
7/8	22.2 [0.875]	12.7 [0.500]	1.65 ± 0.38 [0.065 ± 0.015]
1	25.4 [1.000]	14.5 [0.570]	1.77 ± 0.51 [0.070 ± 0.020]
1 1/4	31.8 [1.250]	18.1 [0.714]	2.20 ± 0.51 [0.087 ± 0.020]
1 1/2	38.1 [1.500]	21.8 [0.857]	2.41 ± 0.51 [0.095 ± 0.020]
1 3/4	44.5 [1.750]	25.4 [1.000]	2.71 ± 0.51 [0.107 ± 0.020]
2	50.8 [2.000]	29.0 [1.140]	2.79 ± 0.51 [0.110 ± 0.020]
3	76.2 [3.000]	43.4 [1.710]	3.17 ± 0.51 [0.125 ± 0.020]
4	101.6 [4.000]	57.9 [2.280]	3.55 ± 0.51 [0.140 ± 0.020]

*Wall thickness will be less if tubing recovery is restricted during shrinkage.

Ordering Information

Color	Standard	Black (-0)
Size selection	Always order the largest size that will shrink snugly over the component to be covered. Special order sizes are available upon request.	
Standard packaging	On spools.	
Ordering description	Specify product name, size and color (for example, NT-MIL 1/4-0).	

Very Flexible, Rugged
Neoprene Elastomer
Tubing

Product Facts

- Remains flexible at low temperatures without cracking
- Offers outstanding resistance to abrasion and physical abuse while providing the flexibility and strain relief needed for rugged applications
- Resistant to most fluids and solvents, including aviation and ground-vehicle fuels, lubricating oil, and hydraulic fluids (see Raychem Specification RT-511)
- Performance exceeds the stringent requirements of SAE-AMS-DTL-23053/1, Class 2
- System 20



NTFR

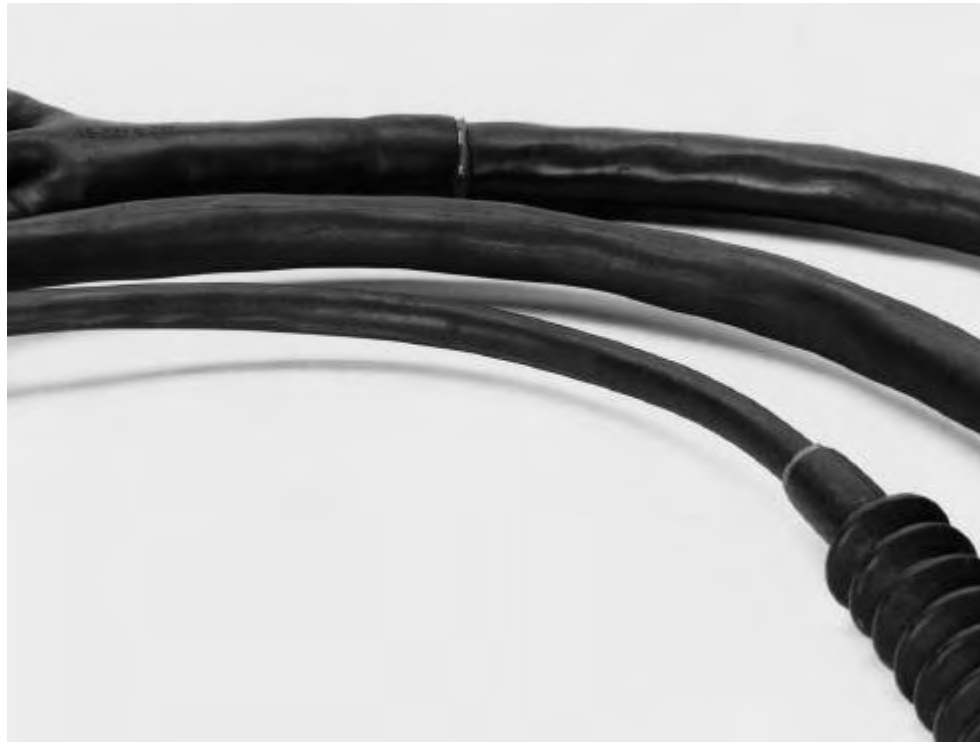

Applications

Widely used for insulation, strain relief, and abrasion protection on cable harnesses and wire bundles in the military and aerospace industries. Especially suitable for applications requiring exposure to fluids and solvents at elevated temperatures.

Installation

Minimum shrink temperature: 90°C [194°F]
Minimum full recovery temperature: 135°C [275°F]

Operating Temperature Range

-70°C to 121°C
[-94°F to 250°F]

Specifications/Approvals

Series	Military	Agency	Raychem
NTFR	SC-X-15112	AMS 3623	RT-511

Available in:	Americas	Europe	Asia Pacific
	■	■	■

Product Dimensions

NTFR (Continued)

Size	Inside Diameter		Recovered Wall Thickness** After Heating
	Minimum Expanded as Supplied	Maximum Recovered After Heating	
1/8	3.2 [0.125]	1.6 [0.061]	0.69 ± 0.20 [0.027 ± 0.008]
3/16	4.8 [0.187]	2.5 [0.100]	0.84 ± 0.25 [0.033 ± 0.010]
1/4	6.4 [0.250]	3.6 [0.143]	0.89 ± 0.25 [0.035 ± 0.010]
3/8	9.5 [0.375]	5.4 [0.211]	1.01 ± 0.25 [0.040 ± 0.010]
1/2	12.7 [0.500]	7.3 [0.286]	1.21 ± 0.38 [0.048 ± 0.015]
5/8	15.9 [0.625]	9.1 [0.357]	1.32 ± 0.38 [0.052 ± 0.015]
3/4	19.1 [0.750]	10.9 [0.428]	1.44 ± 0.38 [0.057 ± 0.015]
7/8	22.2 [0.875]	12.7 [0.500]	1.65 ± 0.38 [0.065 ± 0.015]
1	25.4 [1.000]	14.5 [0.570]	1.77 ± 0.51 [0.070 ± 0.020]
1 1/4	31.8 [1.250]	18.1 [0.714]	2.20 ± 0.51 [0.087 ± 0.020]
1 1/2	38.1 [1.500]	21.8 [0.857]	2.41 ± 0.51 [0.095 ± 0.020]
1 3/4	44.5 [1.750]	25.4 [1.000]	2.71 ± 0.51 [0.107 ± 0.020]
2	50.8 [2.000]	29.0 [1.140]	2.79 ± 0.51 [0.110 ± 0.020]
3	76.2 [3.000]	43.4 [1.710]	3.17 ± 0.51 [0.125 ± 0.020]

**Wall thickness will be less if tubing recovery is restricted during shrinkage.

Ordering Information

Color	Standard	Black (-0)
Size selection	Always order the largest size that will shrink snugly over the component to be covered. Special order sizes are available upon request.	
Standard packaging	On spools.	
Ordering description	Specify product name, size and color (for example, NTFR 1/4-0).	

Semirigid,
Encapsulant-Lined,
Polyolefin Caps

Product Facts

- 3:1 shrink ratio
- Permanent or temporary way to terminate wires
- Rapid, simple installation
- Rugged protection against abrasion, vibration, and flexing
- PD caps provide a splash-resistant, moisture-resistant covering (but not intended for use where immersion in fluids is required)



PD Caps



Applications

PD Caps offer an improved, inexpensive way to encapsulate crimped electrical connections, including those on motor coils. Their encapsulant lining melts and flows to fill surface irregularities of the substrate. These vibration-proof caps are used to insulate and terminate dead-end electrical cables, fixtures, connectors, and other electrical components.

Installation

Minimum shrink temperature: 125°C [257°F]
Minimum full recovery temperature: 135°C [275°F]

Operating Temperature Range

-55°C to 110°C
[-67°F to 230°F]

Specifications/Approvals

Series	UL	Raychem
PD Caps	E85381 600 V, 125°C	PD Caps SCD

Available in:	Americas	Europe	Asia Pacific
	■	■	■

Product Dimensions

PD Caps (Continued)

Size	Length		Inside Diameter		Recovered Wall Thickness** Total Wall After Heating
	Nominal Overall as Supplied	Minimum Open Barrel as Supplied*	Minimum Expanded as Supplied	Maximum Recovered After Heating	
1/8	22.0 [0.87]	12.7 [0.50]	3.2 [0.125]	0.58 [0.023]	1.22 ± 0.15 [0.048 ± 0.006]
3/16	25.4 [1.00]	15.2 [0.60]	4.8 [0.187]	1.52 [0.060]	1.57 ± 0.20 [0.062 ± 0.008]
1/4	28.4 [1.12]	15.2 [0.60]	6.4 [0.250]	2.03 [0.080]	1.98 ± 0.25 [0.078 ± 0.010]
3/8	31.8 [1.25]	18.3 [0.72]	9.5 [0.375]	2.29 [0.090]	2.08 ± 0.25 [0.082 ± 0.010]
1/2	38.1 [1.50]	21.6 [0.85]	12.7 [0.500]	2.29 [0.090]	2.54 ± 0.25 [0.100 ± 0.010]

*See glossary for definition of "barrel."

**Wall thickness will be less if recovery is restricted during shrinkage.

Ordering Information

Color	Standard	Black (-0)
Size selection	Always order the largest size that will shrink snugly over the component to be covered. Special order sizes are available upon request.	
Standard packaging	In pieces.	
Ordering description	Specify product name, size and color (for example, PD Caps 1/4-0).	

Heat-Shrinkable
Water-Blocking System

Product Facts

- Environmentally seals wire bundles of up to 20 wires
- Withstands temperature excursions to 105°C [221°F]
- Provides excellent strain relief and reduces noise
- Offers a low-profile installed product only marginally larger than the cable bundle itself

RayBlock 85



Applications

Designed to provide consistent sealing for cable bundles and the back of connectors. The wires are placed within the channels of a specially formulated hot-melt adhesive profile, then covered by dual-wall, heat-shrinkable tubing with a flame-retardant, radiation-crosslinked outer wall and hot-melt-adhesive inner wall. When the tubing is heated, the hot-melt adhesive melts and the tubing shrinks, forcing the molten adhesive to fill all the voids within the wire bundle and tubing. The result is a solid plug of adhesive molded around each wire in the bundle, creating a moisture-resistant seal.

Installation

Minimum shrink temperature: 80°C [176°F]
Minimum full recovery temperature: 110°C [230°F]

Operating Temperature Range

-40°C to 85°C
[-40°F to 185°F]

Specifications/Approvals

Series	Raychem
RayBlock 85	RayBlock 85 SCD RW-2101

Available in:	Americas	Europe	Asia Pacific
	■	■	■

Product Dimensions

RayBlock 85 (Continued)

Part No.	No. of Channels	Profile			Tubing Inside Diameter		
		Outside Height	Length	Width	Minimum Expanded as Supplied	Maximum Recovered After Heating	Nominal Length
RayBlock 85 Kit 0102-A0	2	8.5 [0.335]	2.75 [0.108]	8.50 [0.335]	12.0 [0.472]	3.0 [0.118]	40 [1.57]
RayBlock 85 Kit 0203-A0	3	8.5 [0.335]	2.75 [0.108]	12.25 [0.482]	24.0 [0.945]	6.0 [0.236]	47 [1.85]
RayBlock 85 Kit 0504-A0	4	8.5 [0.335]	2.75 [0.108]	16.00 [0.630]	16.0 [0.630]	4.0 [0.158]	40 [1.57]
RayBlock 85 Kit 0405-A0	5	8.5 [0.335]	2.75 [0.108]	19.75 [0.778]	24.0 [0.945]	6.0 [0.236]	45 [1.77]
RayBlock 85 Kit 0107-A0	7	8.5 [0.335]	2.75 [0.108]	27.25 [1.070]	24.0 [0.945]	6.0 [0.236]	65 [2.56]
RayBlock 85 Kit 0510-A0	10	8.5 [0.335]	2.75 [0.108]	38.50 [1.520]	32.0 [1.260]	8.0 [0.315]	55 [2.17]

Ordering Information

Color	Standard	Black (-0)
Size selection	For wire with an outside diameter smaller than 2.8 [0.110] , use a maximum of two wires per channel. For wire with an outside diameter of 2.8–3.5 [0.110 to 0.138], use a maximum of one wire per channel. Special order sizes are available upon request.	
Standard packaging	One kit (contains 1000 pcs. of profile and 1000 pcs. of tubing).	

Heat-Shrinkable
Water-Blocking System

Product Facts

- Environmentally seals wire bundles of up to 20 wires
- Withstands temperature excursions to 120°C [248°F]
- Provides excellent strain relief and reduces noise
- Offers a low-profile installed product only marginally larger than the cable bundle itself



RayBlock 105



Applications

Designed to provide consistent sealing for cable bundles and the back of connectors. The wires in the bundle are placed within the channels of a specially formulated hot-melt adhesive profile, and then covered by dual wall, heat-shrinkable tubing with a flame-retardant radiation-crosslinked outer wall and hot-melt-adhesive inner wall. When the tubing is heated, the hot-melt adhesive melts and the tubing shrinks, forcing the molten adhesive to fill all the voids within the wire bundle and tubing. The result is a solid plug of adhesive molded around each wire in the bundle, creating a moisture-resistant seal.

Installation

Minimum shrink temperature: 80°C [176°F]
Minimum full recovery temperature: 110°C [230°F]

Operating Temperature Range

-40°C to 105°C
[-40°F to 221°F]

Specifications/Approvals

Series	Raychem
RayBlock 105	RayBlock 105 SCD RW-2102

Available in:	Americas	Europe	Asia Pacific
	■	■	■

Product Dimensions

RayBlock 105 (Continued)

Part No.	No. of Channels	Profile			Tubing Inside Diameter		
		Outside Height	Length	Width	Minimum Expanded as Supplied	Maximum Recovered After Heating	Nominal Length
RayBlock 105 Kit 0102-A0	2	8.5 [0.335]	2.75 [0.108]	8.50 [0.335]	12.0 [0.472]	3.0 [0.118]	40 [1.57]
RayBlock 105 Kit 0103-A0	3	8.5 [0.335]	2.75 [0.108]	12.25 [0.482]	16.0 [0.630]	4.0 [0.158]	40 [1.57]
RayBlock 105 Kit 0504-A0	4	8.5 [0.335]	2.75 [0.108]	16.00 [0.630]	16.0 [0.630]	4.0 [0.158]	45 [1.77]
RayBlock 105 Kit 0105-A0	5	8.5 [0.335]	2.75 [0.108]	19.75 [0.778]	24.0 [0.945]	6.0 [0.236]	45 [1.77]
RayBlock 105 Kit 0107-A0	7	8.5 [0.335]	2.75 [0.108]	27.20 [1.070]	24.0 [0.945]	6.0 [0.236]	65 [2.56]
RayBlock 105 Kit 0110-A0	10	8.5 [0.335]	2.75 [0.108]	38.50 [1.520]	32.0 [1.260]	8.0 [0.315]	65 [2.56]

Ordering Information

Color	Standard	Black (-0)
Size selection	For wire with an outside diameter smaller than 2.8 [0.110], use a maximum of two wires per channel. For wire with an outside diameter of 2.8–3.5 [0.110–0.138], use a maximum of one wire per channel. Special order sizes are available upon request.	
Standard packaging	One kit (contains 1000 pcs. of profile and 1000 pcs. of tubing).	

PET and PFR Expandable,
Braided, Polyester Sleaving

Product Facts

- Excellent abrasion and cut-through resistance
- Lightweight
- Flexible (even at low temperatures)
- Fungus-proof
- Not affected by most chemicals and solvents, non-hygroscopic
- PFR meets UL VW-1, FAR25, and is Self-Extinguishing
- Fiber diameter is 0.254 [0.010]



Rayflex Tubing

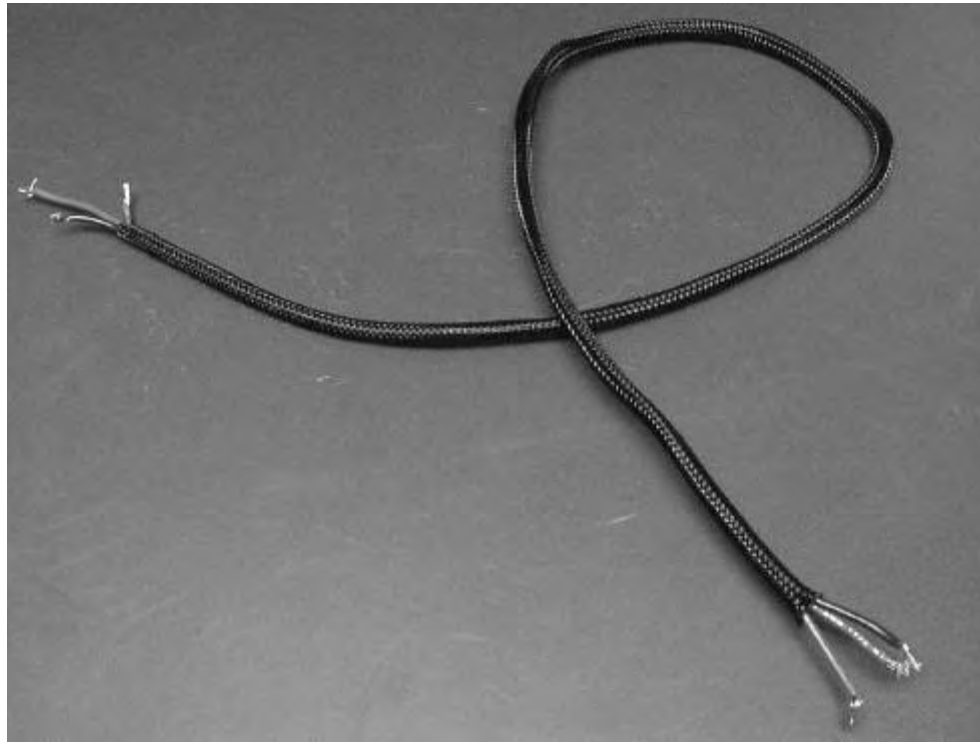

Applications

Rayflex tubing is suited for the mechanical protection of wire harnesses, hoses, and all other applications where exceptional flexibility combined with superior abrasion/cut resistance is required. It also serves as an economical means for wire bundling that will not trap heat or moisture; expanding easily to fit over irregular shapes, then contracting to conform and grip. To prevent fraying, these products should be cut to length using a hot knife.



Installation

This product is cold applied.

Operating Temperature Range

-50°C to 150°C
[-58°F to 302°F]
(220°C [428°F] for short periods)

Specifications/Approvals

Series	UL 	CSA 	Raychem
Rayflex PET			RW-2069
Rayflex PFR	E197586 Rated 125°C	LR31929 Rated 125°C	

Available in:	Americas	Europe	Asia Pacific
		■	■

Product Dimensions

Rayflex Tubing (Continued)

Size	Nominal Size	Size Range
RAYFLEX PET expandable polyester braid		
1/8	3 [0.125]	2.4-6.4 [0.094-0.250]
1/4	6 [0.250]	3.2-9.5 [0.125-0.375]
3/8	10 [0.375]	4.7-16 [0.188-0.630]
1/2	13 [0.500]	6.4-19 [0.250-0.750]
3/4	19 [0.750]	13-32 [0.500-1.250]
1-1/4	32 [1.250]	19-45 [0.750-1.750]
1-3/4	45 [1.750]	32-70 [1.250-2.750]
2	51 [2.000]	38-76 [1.500-3.000]
RAYFLEX PFR flame-retardant, expandable polyester braid		
1/8	3 [0.125]	2.4-6.4 [0.094-0.250]
1/4	6 [0.250]	3.2-9.5 [0.125-0.375]
3/8	10 [0.375]	4.7-16 [0.188-0.630]
1/2	13 [0.500]	6.4-19 [0.250-0.750]
3/4	19 [0.750]	13-32 [0.500-1.250]
1-1/4	32 [1.250]	19-45 [0.750-1.750]
1-3/4	45 [1.750]	32-70 [1.250-2.750]
2	51 [2.000]	38-76 [1.500-3.000]

Ordering Information

Color	Standard	RF-PET: Black (-0) RF-PFR: Black with white X-Cross tracers (-09)
Standard packaging	On spools.	
Ordering description	Specify product name, size and color (for example, RF-PET 1/8-0).	

Expandable, Braided,
Polyester Slewing

Product Facts

- Excellent abrasion and cut-through resistance
- Lightweight construction with 0.22 [.009] fiber
- Flexible (even at low temperatures)
- Fungus-resistant
- Resistant to most chemicals and solvents, non-hygroscopic
- Wide range of metric sizes



Rayflex PETM Tubing

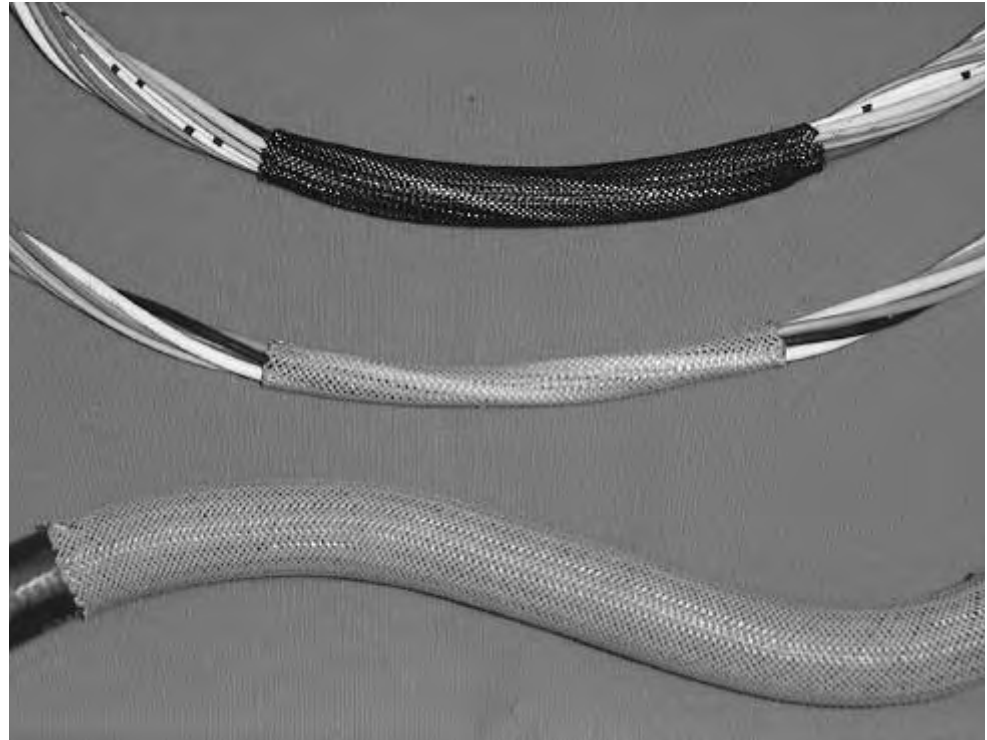

3 Heat-Shrinkable Tubing

Applications

Rayflex tubing is suited for the mechanical protection of wire harnesses, hoses, and all other applications where exceptional flexibility combined with superior abrasion/cut resistance is required. It also serves as an economical means for wire bundling that will not trap heat or moisture; expanding easily to fit over irregular shapes, then contracting to conform and grip. To prevent fraying, these products should be cut to length using a hot knife.

Installation

This product is cold applied.

Operating Temperature Range

-50°C to 150°C
[-58°F to 302°F]
(220°C [428°F] for short periods)

Available in:	Americas	Europe	Asia Pacific
		■	■

Product Dimensions

Rayflex PETM Tubing (Continued)

Nominal Size	Size Range	
	Minimum	Maximum
3 [0.119]	1 [0.039]	5 [0.197]
4 [0.158]	2 [0.079]	7 [0.276]
5 [0.197]	3 [0.118]	9 [0.354]
6 [0.236]	4 [0.158]	12 [0.472]
8 [0.315]	5 [0.197]	12 [0.472]
10 [0.394]	7 [0.276]	15 [0.591]
12 [0.472]	8 [0.315]	17 [0.669]
15 [0.591]	10 [0.394]	20 [0.787]
20 [0.787]	14 [0.551]	26 [1.024]
25 [0.984]	18 [0.709]	34 [1.339]
30 [1.181]	20 [0.787]	40 [1.575]
40 [1.575]	30 [1.181]	50 [1.969]
50 [1.969]	40 [1.575]	60 [2.362]

Ordering Information

Color	Standard	Black (-0), Grey (-8)
Standard packaging	On spools.	
Ordering description	Specify product name, size and color (for example, RF-PETM-03-0).	

Commercial Protective,
Self-Adhering, Edging
Material

Product Facts

- Flexible to allow for protection of curved edges



Rayrim Edging Material

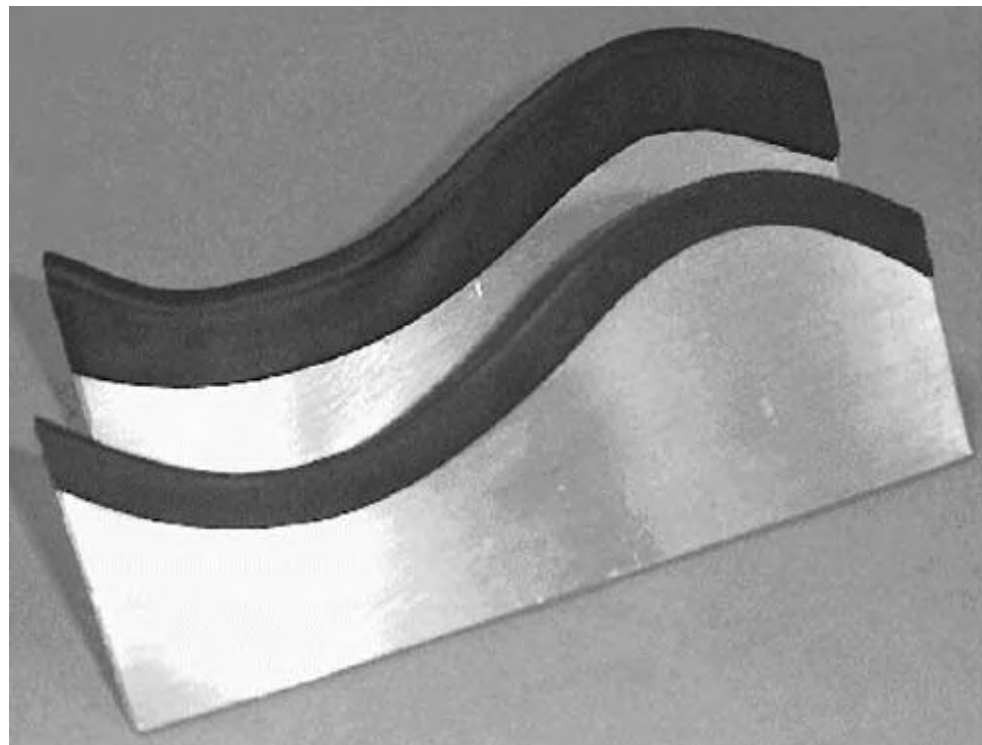

Applications

Raychem Rayrim edging material is an extruded strip internally coated with a heat activated adhesive, so that on heating the profile changes from a "V" to a "U" section and the adhesive bonds to the substrate profile.

Manufactured from a Raychem radiation cross-linked polyolefin material, the profile offers a clean and rapid means of covering metal, wood and glass edges for all-round protection.

The flexible nature of the product allows application to both internal and external radii, as well as straight edges, and the continuous operating temperature of -55°C to +80°C [-67°F to 176°F] means that the product can give protection under the most testing circumstances.

Installation

Minimum shrink temperature: 120°C [248°F]
Minimum full recovery temperature: 150°C [302°F]

Operating Temperature Range

-55°C to 80°C
[-67°F to 176°F]

Specifications/Approvals

Series	Raychem
Rayrim	RK-6182

Available in:	Americas	Europe	Asia Pacific
	■	■	■

Product Dimensions

Rayrim Edging Material (Continued)

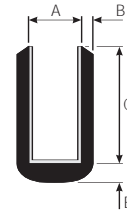
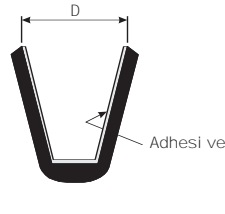

Size	A (maximum)	B (minimum)	C (minimum)	D (minimum)	E (typical)
Nr. 6	0.6 [0.024]	0.5 [0.020]	3.5 [0.138]	0.8 [0.032]	1.25 [0.049]
Nr. 7	1.0 [0.039]	0.9 [0.035]	4.8 [0.189]	1.6 [0.063]	1.25 [0.049]
Nr. 8	2.0 [0.079]	0.9 [0.035]	6.6 [0.260]	2.5 [0.098]	2.25 [0.089]
Nr. 9	4.2 [0.165]	0.9 [0.035]	13.5 [0.532]	4.5 [0.177]	2.20 [0.087]

Application range

Plate SWG	Thickness	Recommended minimum bend radius
30-24	0.31-0.56 [0.012-0.022]	10 [0.394]
23-16	0.61-1.63 [0.026-0.064]	15 [0.591]
15-10	1.83-3.25 [0.072-0.128]	20 [0.787]
9-5	3.66-5.38 [0.144-0.212]	25 [0.984]

Ordering Information

Color	Standard	Black (-0)
Size selection	Always order the largest size that will shrink snugly on edge of the panel.	
Standard packaging	1.2-meter [4-foot] lengths.	
Ordering description	Specify product name, size number and color (for example, Rayrim Nr.6-0).	

High-Performance,
Flame-Resistant, Flexible,
Fluoropolymer Tubing

Product Facts

- 2:1 shrink ratio
- Approximately 40 percent thinner walls than most general purpose polyolefin tubings
- High flame-resistance
- Excellent physical and electrical properties after exposure to many chemicals and solvents at 50°C [122°F] (but not recommended for use in direct contact with ketones)
- Recommended maximum temperature for use as a primary insulator: 135°C [275°F]



Applications

Can be used for jacketing and bundling of wires to form light-duty harnesses, especially where a low profile, abrasion resistance, and flexibility are needed. Can also be used to provide insulation and strain relief of electrical connections and wire terminations, identification of wires, and packaging of components.

Installation

Minimum shrink temperature: 110°C [230°F]
Minimum full recovery temperature: 150°C [302°F]

Operating Temperature Range

-55°C to 150°C
[-67°F to 302°F]

Specifications/Approvals

Series	UL 	Military	Raychem
RNF-150	E35586 VW-1 600 V, 150°C	AMS-DTL-23053/18*, Class 2	RT-370

*Formerly MIL-I-23053/18 and MIL-DTL-23053/18.

Available in:	Americas	Europe	Asia Pacific
	■	■	■

Product Dimensions

RNF-150 (Continued)

Size	Inside Diameter		Recovered Wall Thickness** After Heating
	Minimum Expanded as Supplied	Maximum Recovered After Heating	
3/64	1.2 [0.046]	0.6 [0.023]	0.25 ± 0.05 [0.010 ± 0.002]
1/16	1.6 [0.063]	0.8 [0.031]	0.25 ± 0.05 [0.010 ± 0.002]
3/32	2.4 [0.093]	1.2 [0.046]	0.25 ± 0.05 [0.010 ± 0.002]
1/8	3.2 [0.125]	1.6 [0.062]	0.25 ± 0.05 [0.010 ± 0.002]
3/16	4.8 [0.187]	2.4 [0.093]	0.25 ± 0.05 [0.010 ± 0.002]
1/4	6.4 [0.250]	3.2 [0.125]	0.30 ± 0.08 [0.012 ± 0.003]
3/8	9.5 [0.375]	4.8 [0.187]	0.30 ± 0.08 [0.012 ± 0.003]
1/2	12.7 [0.500]	6.4 [0.250]	0.30 ± 0.08 [0.012 ± 0.003]
3/4	19.1 [0.750]	9.5 [0.375]	0.43 ± 0.08 [0.017 ± 0.003]
1	25.4 [1.000]	12.7 [0.500]	0.48 ± 0.08 [0.019 ± 0.003]

**Wall thickness will be less if tubing recovery is restricted during shrinkage.

Ordering Information

Color	Standard	Black (-0)
	Nonstandard	White (-9)
Size selection	Always order the largest size that will shrink snugly over the component to be covered. Special order sizes are available upon request.	
Standard packaging	On spools.	
Ordering description***	Specify product name, size and color (for example, RNF-150 1/4-0).	

***Europe only. For supply to MIL, Def Stan and BS add -MS, -DS or -BS to ordering description.

Clear, Flame-Resistant,
Flexible, Fluoropolymer
Tubing

Product Facts

- 2:1 shrink ratio
- Exceptional clarity and clarity stability
- Toughness, chemical resistance, and high-temperature performance
- High flame-resistance
- Approximately 40 percent thinner walls than most general purpose polyolefin tubings
- Recommended maximum temperature for use as a primary insulator: 135°C [275°F]



RT-375

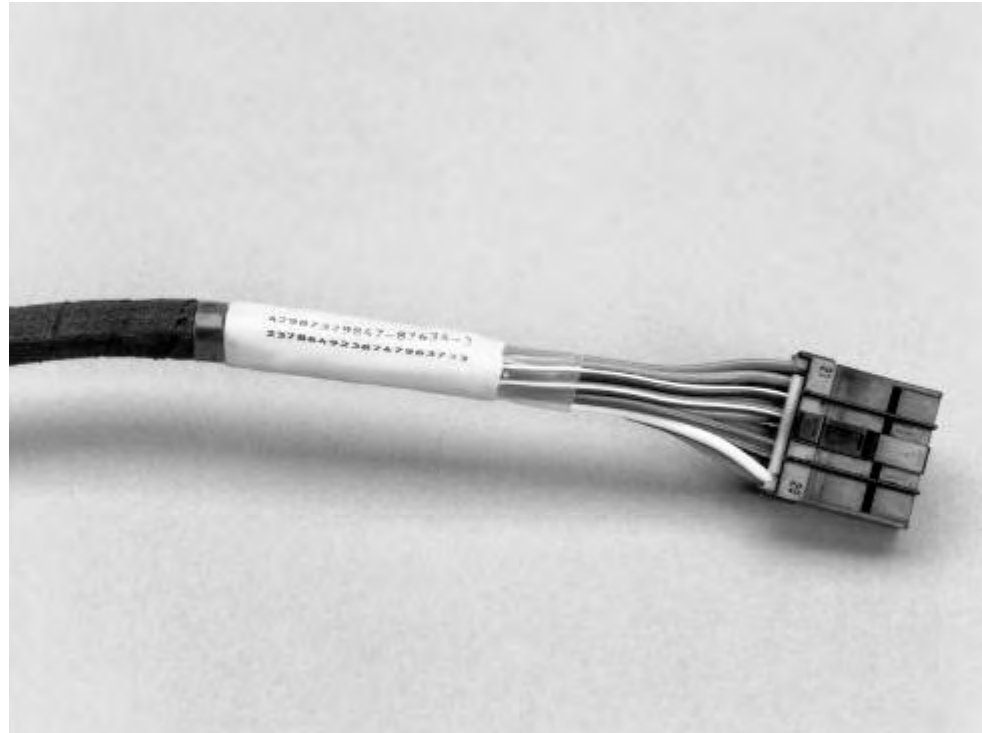

3 Heat-Shrinkable Tubing

Applications

Protects wire and cable markers subject to extreme abuse, while permitting full inspectability of each item covered. Provides bundling and jacketing of wires and cables, protecting them from mechanical and chemical abuse. Protects electronic components while permitting their identification and inspection.



Installation

Minimum shrink temperature: 125°C [257°F]
Minimum full recovery temperature: 150°C [302°F]

Operating Temperature Range

-55°C to 150°C
[-67°F to 302°F]

Specifications/Approvals

Series	UL 	CSA 	Military	Raychem
RT-375	E35586 VW-1 600 V, 150°C	LR31929 VW-1 600 V, 150°C	AMS-DTL-23053/18*, Class 2	RT-375

*Formerly MIL-I-23053/18 and MIL-DTL-23053/18.

Available in:	Americas	Europe	Asia Pacific
	■	■	■

Product Dimensions

RT-375 (Continued)

Size	Inside Diameter		Recovered Wall Thickness** After Heating
	Minimum Expanded as Supplied	Maximum Recovered After Heating	
3/64	1.2 [0.046]	0.6 [0.023]	0.25 ± 0.05 [0.010 ± 0.002]
1/16	1.6 [0.063]	0.8 [0.031]	0.25 ± 0.05 [0.010 ± 0.002]
3/32	2.4 [0.093]	1.2 [0.046]	0.25 ± 0.05 [0.010 ± 0.002]
1/8	3.2 [0.125]	1.6 [0.062]	0.25 ± 0.05 [0.010 ± 0.002]
3/16	4.8 [0.187]	2.4 [0.093]	0.25 ± 0.05 [0.010 ± 0.002]
1/4	6.4 [0.250]	3.2 [0.125]	0.30 ± 0.08 [0.012 ± 0.003]
3/8	9.5 [0.375]	4.8 [0.187]	0.30 ± 0.08 [0.012 ± 0.003]
1/2	12.7 [0.500]	6.4 [0.250]	0.30 ± 0.08 [0.012 ± 0.003]
3/4	19.1 [0.750]	9.5 [0.375]	0.43 ± 0.08 [0.017 ± 0.003]
1	25.4 [1.000]	12.7 [0.500]	0.48 ± 0.08 [0.019 ± 0.003]

**Wall thickness will be less if tubing recovery is restricted during shrinkage.

Ordering Information

Color	Standard	Clear (-X)
Size selection	Always order the largest size that will shrink snugly over the component to be covered. Special order sizes are available upon request.	
Standard packaging	On spools.	
Ordering description***	Specify product name, size and color (for example, RT-375 1/4-X).	

***Europe only. For supply to MIL, Def Stan and BS add -MS, -DS or -BS to ordering description.

Fluid-Resistant, Chemical-Resistant, Crosslinked Fluoropolymer Tubing with Extended Temperature Range

Product Facts

- Resistance to high temperatures, solvents, corrosive chemicals, and radiation
- Extreme resistance to hydrocarbons
- Low outgassing (successfully tested for NASA outgassing requirements)
- Highly flame-retardant
- 40 percent lighter weight than tubing made with Viton® fluoroelastomer
- System 300 tubing



RT555

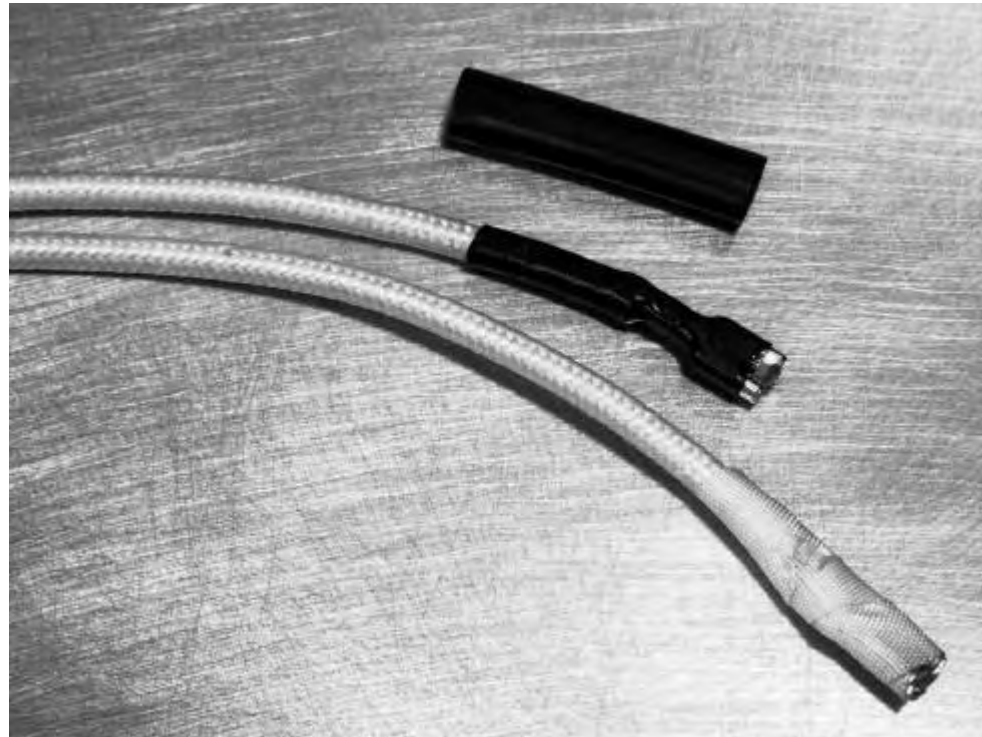

Applications

Suitable for commercial applications requiring heat resistance (electrical and hydraulic systems near aircraft or automotive engines or in fuel tanks), applications in chemically exposed environments (industrial process equipment in the pulp and paper, steel, and chemical industries), and equipment for handling caustic or dangerous chemicals or inks. Use for insulation and strain relief on appliances (electric ranges, microwave ovens, gas grills, and industrial paint-drying equipment) and for protection of delicate electronic instruments in down-hole applications.

Installation

Minimum shrink temperature: 150°C [302°F]
 Minimum full recovery temperature: 220°C [428°F]

Operating Temperature Range

-65°C to 200°C
 [-85°F to 392°F]

Specifications/Approvals

Series	UL RU	Raychem
RT555	Listed for 185°C for 100,000-hr continuous use (File E85381) Listed for 200°C for 40,000-hr cumulative intermittent exposure	RT-555

VITON is a trademark of Dupont Dow Elastomers LLC.

Available in:	Americas	Europe	Asia Pacific
	■	■	■

Catalog 1654025
 Revised 12-04
www.tycoelectronics.com

Dimensions are in millimeters and inches unless otherwise specified. Values in brackets are U.S. equivalents.

Dimensions are shown for reference purposes only. Specifications subject to change.

USA: 1-800-522-6752
 Canada: 1-905-470-4425
 Mexico: 01-800-733-8926
 C. America: 52-55-5-729-0425

South America: 55-11-3611-1514
 Japan: 81-44-900-5102
 Singapore: 65-4866-151
 UK: 44-1793-528171

Product Dimensions

RT555 (Continued)

Size	Inside diameter		Recovered wall thickness* After heating		
	Minimum expanded as supplied	Maximum recovered after heating	Recovered wall thickness*		
			Minimum	Maximum	Nominal
1/8	3.18 [0.125]	1.57 [0.062]	0.25 [0.010]	0.41 [0.016]	0.30 [0.012]
3/16	4.75 [0.187]	2.36 [0.093]	0.28 [0.011]	0.46 [0.018]	0.36 [0.014]
1/4	6.35 [0.250]	3.18 [0.125]	0.33 [0.013]	0.51 [0.020]	0.41 [0.016]
3/8	9.53 [0.375]	4.75 [0.187]	0.41 [0.016]	0.58 [0.023]	0.48 [0.019]
1/2	12.70 [0.500]	6.35 [0.250]	0.41 [0.016]	0.58 [0.023]	0.48 [0.019]
5/8	15.88 [0.625]	7.95 [0.313]	0.48 [0.019]	0.66 [0.026]	0.56 [0.022]
3/4	19.05 [0.750]	9.53 [0.375]	0.61 [0.024]	0.79 [0.031]	0.69 [0.027]
1	25.40 [1.000]	12.70 [0.500]	0.71 [0.028]	0.89 [0.035]	0.79 [0.031]
1 1/4	31.75 [1.250]	15.88 [0.625]	0.76 [0.030]	0.94 [0.037]	0.84 [0.033]
1 1/2	38.10 [1.500]	19.05 [0.750]	0.86 [0.034]	1.04 [0.041]	0.94 [0.037]
2	50.80 [2.000]	25.40 [1.000]	0.94 [0.037]	1.12 [0.044]	1.02 [0.040]

*Wall thickness will be less if tubing recovery is restricted during shrinkage.

Ordering Information

Color	Standard Black (-0)
Size selection	Always order the largest size that will shrink snugly over the component to be covered. Special order sizes are available upon request.
Standard packaging	On spools.
Ordering description	Specify product name, size and color (for example, RT555 1/8-0).

High temperature,
Chemical-Resistant,
Polyvinylidene Fluoride
Tubing

Product Facts

- 2:1 shrink ratio
- Tough, semirigid, very-thin-wall insulation
- High flame-resistance, meeting the requirements of AMS-DTL-23053*, Test C, with UL and CSA VW-1 rating
- High-temperature performance that meets or exceeds military and industrial standards
- Protection from most industrial solvents, fuels, and chemicals
- Recommended maximum temperature for use as a primary insulator: 135°C [275°F]



Applications

Especially suitable for applications requiring high-temperature performance, outstanding abrasion resistance and cut-through resistance, or superior chemical and solvent properties. Provides electrical insulation and strain relief of multipin connectors and solder joints. Ideal for applications that require dense packing of components or visual inspection of covered components.

Installation

Minimum shrink temperature: 155°C [311°F]
Minimum full recovery temperature: 175°C [347°F]

Operating Temperature Range

-55°C to 175°C
[-67°F to 347°F]

Specifications/Approvals

Series	UL	CSA	Military	Industry	Raychem
RW-175	E35586 VW-1 600 V, 150°C	LR31929 VW-1 600 V, 150°C	AMS-DTL-23053/8* Def. Stan. 59-97 Type 3 VG 95343 Pt 5 Type F BS 3G 198 Pt4	VDE 0341 Pt 9005	RW-3029/1 RW-3029/2

*Formerly MIL-I-23053 and MIL-DTL-23053/8.

Available in:	Americas	Europe	Asia Pacific
	■	■	■

Product Dimensions

RW-175 (Continued)

Size	Inside Diameter		Recovered Wall Thickness** After Heating
	Minimum Expanded as Supplied	Maximum Recovered After Heating	
3/64	1.2 [0.046]	0.6 [0.023]	0.25 ± 0.05 [0.010 ± 0.002]
1/16	1.6 [0.063]	0.8 [0.031]	0.25 ± 0.05 [0.010 ± 0.002]
3/32	2.4 [0.093]	1.2 [0.046]	0.25 ± 0.05 [0.010 ± 0.002]
1/8	3.2 [0.125]	1.6 [0.062]	0.25 ± 0.05 [0.010 ± 0.002]
3/16	4.8 [0.187]	2.4 [0.093]	0.25 ± 0.05 [0.010 ± 0.002]
1/4	6.4 [0.250]	3.2 [0.125]	0.33 ± 0.05 [0.013 ± 0.002]
3/8	9.5 [0.375]	4.8 [0.187]	0.33 ± 0.05 [0.013 ± 0.002]
1/2	12.7 [0.500]	6.4 [0.250]	0.33 ± 0.05 [0.013 ± 0.002]
3/4	19.1 [0.750]	9.5 [0.375]	0.43 ± 0.08 [0.017 ± 0.003]
1	25.4 [1.000]	12.7 [0.500]	0.48 ± 0.08 [0.019 ± 0.003]
1 1/2	38.1 [1.500]	19.1 [0.750]	0.51 ± 0.08 [0.020 ± 0.003]

**Wall thickness will be less if tubing recovery is restricted during shrinkage.

Ordering Information

Color	Standard	Clear (-X)
	Nonstandard	Black (-0)
Size selection	Always order the largest size that will shrink snugly over the component to be covered. Special order sizes are available upon request.	
Standard packaging	In 1.2-meter [4-foot] lengths.	
Ordering description***	Specify product name, size and color (for example, RW-175 3/64-X).	

***Europe only. For supply to MIL, Def Stan and BS add -MS, -DS or -BS to ordering description.

Very Flexible,
Flame-Retardant,
Silicone Elastomer
Tubing

Product Facts

- Outstanding low-temperature flexibility
- Resistance to hydraulic fluids, fuel, and lubricating oil
- Very good ablative characteristics: when exposed to flame, surface turns to insulative char or “ablates”

SFR



Applications

Provides cable jacketing, harness protection, and strain relief for electronic components, semi-conductor leads, and wire splices. Ideal for applications that require flexibility over a wide range of operating temperatures.

Installation

Minimum shrink temperature: 135°C [285°F]
Minimum full recovery temperature: 175°C [347°F]

Operating Temperature Range

-75°C to 180°C
[-103°F to 356°F]

Specifications/Approvals

Series	Military	Raychem
SFR	AMS-DTL-23053/10* MIL-PRF-46846, Type II, Class 1	RT-1140

*Formerly MIL-I-23053/10 and MIL-DTL-23053/10.

Available in:	Americas	Europe	Asia Pacific
	■	■	■

Product Dimensions

SFR (Continued)

Size	Inside Diameter		Recovered Wall Thickness** After Heating
	Minimum Expanded as Supplied	Maximum Recovered After Heating	
1/4	6.4 [0.250]	3.6 [0.143]	0.88 ± 0.25 [0.035 ± 0.010]
3/8	9.5 [0.375]	5.4 [0.214]	1.02 ± 0.25 [0.040 ± 0.010]
1/2	12.7 [0.500]	7.3 [0.286]	1.21 ± 0.38 [0.048 ± 0.015]
5/8	15.9 [0.625]	9.1 [0.357]	1.32 ± 0.38 [0.052 ± 0.015]
3/4	19.1 [0.750]	10.9 [0.428]	1.44 ± 0.38 [0.057 ± 0.015]
7/8	22.2 [0.875]	12.7 [0.500]	1.65 ± 0.38 [0.065 ± 0.015]
1	25.4 [1.000]	14.5 [0.570]	1.77 ± 0.51 [0.070 ± 0.020]
1 1/4	31.8 [1.250]	18.1 [0.714]	2.21 ± 0.51 [0.087 ± 0.020]
1 1/2	38.1 [1.500]	21.8 [0.857]	2.41 ± 0.51 [0.095 ± 0.020]
1 3/4	44.5 [1.750]	25.4 [1.000]	2.71 ± 0.51 [0.107 ± 0.020]
2	50.8 [2.000]	29.0 [1.140]	2.79 ± 0.51 [0.110 ± 0.020]

**Wall thickness will be less if tubing recovery is restricted during shrinkage.

Ordering Information

Color	Standard	Black (-0)
Size selection	Always order the largest size that will shrink snugly over the component to be covered. Special order sizes are available upon request.	
Standard packaging	On spools.	
Ordering description***	Specify product name, size and color (for example, SFR 1/4-0).	

***Europe only. For supply to MIL, Def Stan and BS add -MS, -DS or -BS to ordering description.

Highly Flexible, Silicone Rubber Tubing

Product Facts

- Highly flame-retardant
- Extremely flexible at high and low temperatures
- Shrink ratio 1.5:1 minimum except sizes 4/2.9 and 29/20



SRFR



Applications

Highly flexible and resistant to high and low temperatures. Unlike other silicone materials, SRFR displays outstanding physical strength. It resists extreme heat shocks, and exhibits good thermal insulation. SRFR is non-burning and has outstanding ablative properties as well as excellent physical and electrical properties. SRFR is used in medical equipment where its key

properties are outstanding flexibility and ability to withstand exposure to sterilization conditions. Other applications include thyristor power cable insulation, heating element and bus bar insulation, fiber optic bundle sheathing, and rocketry support cable protection.

Installation

Minimum shrink temperature: 135°C [275°F]
 Minimum full recovery temperature: 175°C [347°F]

Operating Temperature Range

-75°C to 200°C
 [-103°F to 392°F]

Specifications/Approvals

Series	UL	Raychem
SRFR	E85381 VW-1 600V, 200°C	RT-1142 RW- 2057

Available in:	Americas	Europe	Asia Pacific
	■	■	■

Product Dimensions

SRFR (Continued)

Size	Inside Diameter		Recovered Wall Thickness** After Heating (Nominal)
	Minimum Expanded as Supplied	Maximum Recovered After Heating	
2.9/1.7	2.9 [0.114]	1.7 [0.067]	1.0 ± 0.50 [0.039 ± 0.020]
4/2.9	4.0 [0.158]	2.9 [0.114]	1.0 ± 0.50 [0.039 ± 0.020]
7.8/4.6	7.8 [0.307]	4.6 [0.181]	1.0 ± 0.50 [0.039 ± 0.020]
10/6.5	10.0 [0.394]	6.5 [0.256]	1.5 ± 0.50 [0.059 ± 0.020]
15/9.6	15.0 [0.591]	9.6 [0.378]	1.5 ± 0.50 [0.059 ± 0.020]
21/13	21.0 [0.827]	13.0 [0.512]	2.0 ± 0.75 [0.079 ± 0.030]
29/20	29.0 [1.142]	20.0 [0.787]	2.0 ± 0.75 [0.079 ± 0.030]
41/27	41.0 [1.614]	27.0 [1.063]	3.0 ± 1.00 [0.118 ± 0.039]
51/33	51.0 [2.008]	33.0 [1.299]	3.0 ± 1.00 [0.118 ± 0.039]

**Wall thickness will be less if tubing recovery is restricted during shrinkage.

Ordering Information

Color	Standard	Gray (-8)
Size selection	Always order the largest size that will shrink snugly over the component to be covered.	
Standard packaging	On spools.	
Ordering description	Specify product name, size and color (for example, SRFR 2.9/1.7-8).	

High-Temperature,
Chemically Inert, Modified
Tubing made with Teflon®
Fluoropolymer

Product Facts

- Shrink ratio: 1.8:1 (TFE)
3.2:1 (TFE-R)
- High flame-resistance
- Excellent chemical resistance



TFE and TFE-R



Applications

Designed to provide insulation and mechanical protection in severe chemical and thermal environments. Used to cover hydraulic hose and couplings to prevent contamination and corrosion. The high mechanical strength and extremely low coefficient of friction make it ideal for reducing damage to bearing shafts and similar applications.

Installation

Minimum shrink temperature: 330°C [625°F]
Minimum full recovery temperature: 340°C [644°F]

Operating Temperature Range

-67°C to 250°C
[-88.6°F to 482°F]

Specifications/Approvals

Series	Military	Raychem
TFE, TFE-R	AMS-DTL-23053/12*, Classes 1 and 3 Def. Stan. 59-97 Type 5A (TFE) Def. Stan. 59-97 Type 5B (TFE-R)	RW-2055 (TFE) RW-2054 (TFE-R)

*Formerly MIL-I-23053/12 and MIL-DTL-23053/12.

TEFLON is a trademark of E.I. du Pont de Nemours and Company

Available in:	Americas	Europe	Asia Pacific
		■	■

Product Dimensions
(millimeters)

TFE and TFE-R (Continued)

Size		Inside Diameter				Recovered Wall Thickness**	
		Minimum Expanded as Supplied		Maximum Recovered After Heating		After Heating (Nominal)	
TFE	TFE-R	TFE	TFE-R	TFE	TFE-R	TFE	TFE-R
30	5/64	0.8	2.0	0.38	0.6	0.23	0.23
28	1/8	0.9	3.2	0.46	1.0	0.23	0.25
26	1/4	1.1	6.4	0.56	1.6	0.25	0.30
24	3/8	1.2	9.5	0.68	2.4	0.25	0.30
22	1/2	1.4	12.7	0.81	3.7	0.30	0.38
20	5/8	1.5	15.9	0.99	4.5	0.30	0.38
18	3/4	1.9	19.0	1.24	5.7	0.30	0.38
16	1	2.3	25.4	1.55	7.1	0.30	0.38
14	1 1/4	3.0	32.0	1.83	8.8	0.30	0.38
12		3.8		2.26		0.30	
10		4.8		2.84		0.30	
8		6.1		3.58	—	0.38	—
6	—	7.6	—	4.52	—	0.38	—
4	—	9.4	—	5.69	—	0.38	—
2	—	10.9	—	7.06	—	0.38	—
0	—	11.9	—	8.81	—	0.38	—

**Wall thickness will be less if tubing recovery is restricted during shrinkage.

Ordering Information

Color	Standard	Clear (-X)
Size selection	Always order the largest size that will shrink snugly over the component to be covered. Special order sizes are available upon request.	
Standard packaging	In 1.2-meter [4-foot] lengths.	
Ordering description***	Specify product name, size and color (for example, TFE 22-X).	

***Europe only. For supply to MIL, Def Stan and BS add -MS, -DS or -BS to ordering description.

Heat-Shrinkable,
Chemical-Resistant,
High-Temperature Tubing

Product Facts

- High resistance to impact and abrasion
- Resistance to a wide variety of fuels, lubricants, acids, and solvents at elevated temperatures
- Flexibility at low temperatures without cracking



Viton®/Viton®-HW/Viton®-E/Viton®-TW



Applications

Raychem premium heat-shrinkable tubing is fabricated from Viton® fluoro-elastomers – a crosslinked material designed for a wide range of applications. It is available in three configurations. Viton®-E is the thickest wall version, Viton®-HW has a thinner wall. Viton® and Viton®-TW have the thinnest wall for lighter weight applications. Offering fluid resistance, Viton® tubing can be used in applications up to 200°C [392°F].

Installation

Minimum shrink temperature: 100°C [212°F]
Minimum full recovery temperature: 175°C [347°F]

Operating Temperature Range

Viton®, Viton®-HW, and Viton®-TW: -40°C* to 200°C [-40°F to 392°F]
Viton®-E: -55°C to 200°C [-67°F to 392°F]

Specifications/Approvals

Series	Military	Raychem
Viton® Viton®-TW	AMS-DTL 23053/13**	RT-1146 RK-6014/2
Viton®-E	Def. Stan. 59-97 Issue 3 Type 4A VG 95343 Part 5 Type E VDE 0341/Pt9005 BS 4G-198 Part 3 12A	RK-6014
Viton®-HW	MIL-PRF-46846 Type III, Class I	RT-1145

*Viton®-TW is rated for -5°C when tested in accordance with RK-6014/2.
**Formerly MIL-I-23053/13 and MIL-DTL-23053/13.

VITON is a trademark of Dupont Dow Elastomers LLC.

Available in:	Americas	Europe	Asia Pacific
	■	■	■

Catalog 1654025
Revised 12-04
www.tycoelectronics.com

Dimensions are in millimeters and inches unless otherwise specified. Values in brackets are U.S. equivalents.

Dimensions are shown for reference purposes only. Specifications subject to change.

USA: 1-800-522-6752
Canada: 1-905-470-4425
Mexico: 01-800-733-8926
C. America: 52-55-5-729-0425

South America: 55-11-3611-1514
Japan: 81-44-900-5102
Singapore: 65-4866-151
UK: 44-1793-528171

Product Dimensions

Viton®/Viton®-HW/Viton®-E/Viton®-TW (Continued)

Size	Inside Diameter		Recovered Wall Thickness***		
	Minimum Expanded as Supplied	Maximum Recovered After Heating	After Heating (Nominal)		
			Viton®-E	Viton®-HW	Viton®/Viton®-TW
1/8	3.2 [0.125]	1.6 [0.062]	0.76 [0.030]	—	0.76 [0.030]
3/16	4.8 [0.187]	2.4 [0.093]	0.84 [0.033]	—	0.89 [0.035]
1/4	6.4 [0.250]	3.2 [0.125]	0.89 [0.035]	0.76 [0.030]	0.89 [0.035]
3/8	9.5 [0.375]	4.8 [0.187]	1.02 [0.040]	0.89 [0.035]	0.89 [0.035]
1/2	12.7 [0.500]	6.4 [0.250]	1.22 [0.048]	1.09 [0.043]	0.89 [0.035]
5/8	15.9 [0.625]	7.9 [0.312]	—	1.19 [0.047]	1.07 [0.042]
3/4	19.1 [0.750]	9.5 [0.375]	1.45 [0.057]	1.32 [0.057]	1.07 [0.042]
7/8	22.2 [0.875]	11.1 [0.437]	—	1.53 [0.060]	1.25 [0.049]
1	25.4 [1.000]	12.7 [0.500]	1.78 [0.070]	1.65 [0.065]	1.25 [0.049]
1 1/4	31.8 [1.250]	15.9 [0.625]	—	1.78 [0.070]	1.40 [0.055]
1 1/2	38.1 [1.500]	19.1 [0.750]	2.41 [0.095]	1.91 [0.075]	1.40 [0.055]
2	50.8 [2.000]	25.4 [1.000]	2.79 [0.110]	2.79 [0.110]	1.65 [0.065]

***Wall thickness will be less if tubing recovery is restricted during shrinkage.

Ordering Information

Color	Standard	Black (-0)
Size selection	Always order the largest size that will shrink snugly over the component to be covered. Special order sizes are available upon request.	
Standard packaging	On spools.	
Ordering description****	Specify product name, size and color (for example, Viton® 1/4-0).	

****Europe only. For supply to MIL, Def Stan and BS add -MS, -DS or -BS to ordering description.

VITON is a trademark of Dupont Dow Elastomers LLC.

Halogen-Free,
Flame-Retardant,
Heat-Shrinkable Tubing

Product Facts

- Emits minimal amounts of toxic or acid gases during combustion
- Meets performance requirements of MIL-C-24640 and MIL-C-24643 cable jackets
- Resists moisture, fungus, and weathering
- Available in expansion ratios as high as 3:1
- XFFR has the following approvals:
 - ABS (American Bureau of Shipping)
 - DNV (Det Norske Veritas)
 - Lloyd's (Lloyd's Register of Shipping)

XFFR



Applications

XFFR halogen-free tubing can be used for re-jacketing and repairing halogen-free cables in any enclosed area where a flame-retardant, halogen-free environment is required. These environments include tunnels, buildings, mass transit vehicles, and ships. When installed with SFTS-FR1 tape, the tubing can also be used in applications requiring water sealing and protection from abrasion and corrosion.

Installation

Minimum shrink temperature: 70°C [158°F]
Minimum full recovery temperature: 121°C [250°F]

Operating Temperature Range

-55°C to 105°C
[-67°F to 221°F]

Specifications/Approvals

Series	Military	Industry	Raychem
XFFR	MIL-C-24643	NES 713 NES 711	RW-2016

Available in:	Americas	Europe	Asia Pacific
	■	■	■

Product Dimensions

XFFR (Continued)

Size	Inside Diameter		Recovered Wall Thickness* After Heating (Nominal)
	Minimum Expanded as Supplied	Maximum Recovered After Heating	
XFFR-03	7.62 [0.300]	2.54 [0.100]	1.52 [0.060]
XFFR-04	10.16 [0.400]	3.81 [0.150]	1.52 [0.060]
XFFR-07	19.05 [0.750]	5.59 [0.220]	2.03 [0.080]
XFFR-11	27.94 [1.100]	9.52 [0.375]	2.67 [0.105]
XFFR-15	38.10 [1.500]	12.70 [0.500]	3.05 [0.120]
XFFR-20	50.80 [2.000]	19.05 [0.750]	3.05 [0.120]
XFFR-30	76.20 [3.000]	31.75 [1.250]	3.94 [0.155]

*Wall thickness will be less if tubing recovery is restricted during shrinkage.

Ordering Information

Color	Standard	Black (-0)
Size selection	Always order the largest size that will shrink snugly over the component to be covered.	
Standard packaging	1.2-meter [4-foot] or 7.5-meter [25-foot] lengths.	

Part Numbering System

XFFR - 03 X 4 / NM

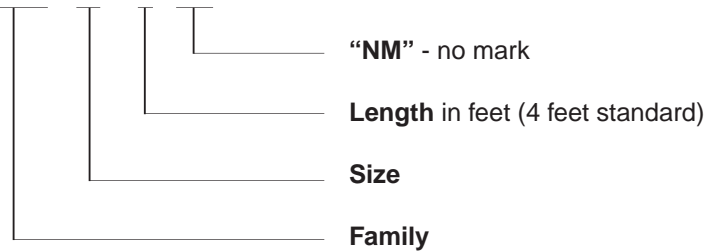

No adhesive.

Flexible, Thin-Wall, Low-Fire-Hazard Tubing

Product Facts

- 2:1 shrink ratio
- Low smoke emissions
- Flexible, flame-retardant
- No added halogens
- Low evolution of acid gases



ZH-100

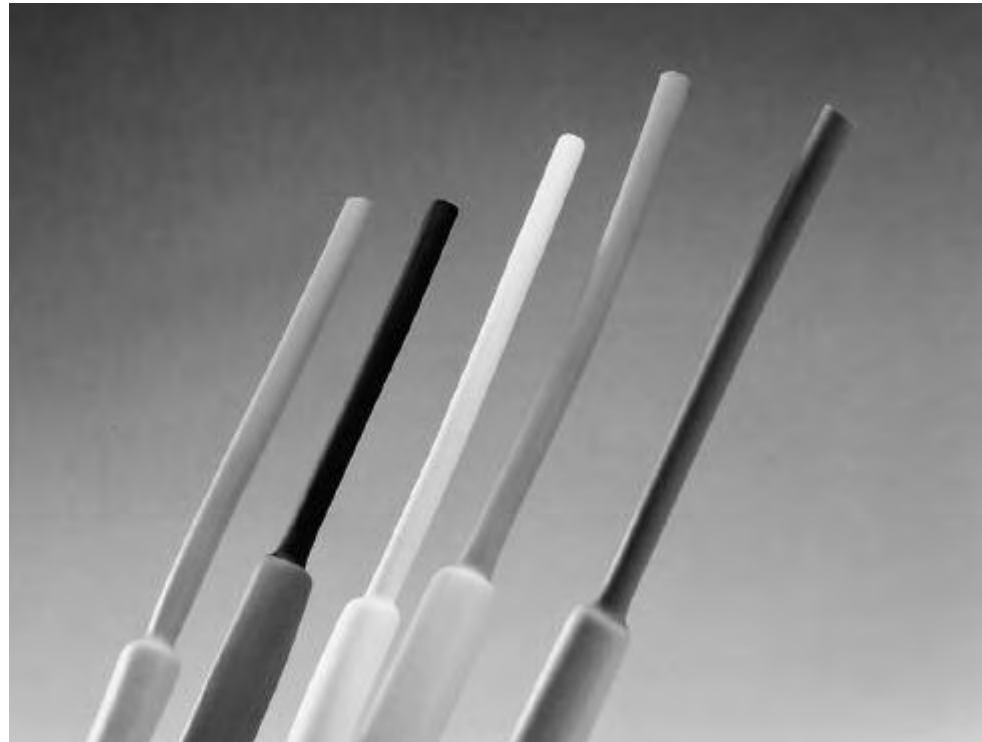

Applications

ZH-100 is a flexible, thin-wall, heat-shrinkable tubing designed for low-fire-hazard applications. ZH-100 contains no added halogens, and exhibits excellent fire safety characteristics combined with low evolution of acid gases, while retaining good mechanical and fluid resistance properties.

Installation

Minimum shrink temperature: 80°C [176°F]
 Minimum full recovery temperature: 120°C [248°F]

Operating Temperature Range

-30°C to 105°C
 [-22°F to 221°F]

Specifications/Approvals

Series	Military	Agency	Raychem
ZH-100	Def. Stan. 59-97 Issue 3 Type 8	BR 1326A BS 3G-198 Part 3 Type 15	RW-2031

Available in:	Americas	Europe	Asia Pacific
	■	■	■

Product Dimensions

ZH-100 (Continued)

Size	Inside Diameter		Recovered Wall Thickness* After Heating
	Minimum Expanded as Supplied	Maximum Recovered After Heating	
1/8	3.2 [0.125]	1.6 [0.062]	0.50 ± 0.10 [0.019 ± 0.004]
3/16	4.8 [0.187]	2.4 [0.093]	0.50 ± .0.10 [0.019 ± 0.004]
1/4	6.4 [0.250]	3.2 [0.125]	0.65 ± 0.15 [0.026 ± 0.006]
3/8	9.5 [0.375]	4.8 [0.187]	0.65 ± 0.15 [0.026 ± 0.006]
1/2	12.7 [0.500]	6.4 [0.250]	0.65 ± 0.15 [0.026 ± 0.006]
3/4	19.0 [0.750]	9.5 [0.375]	0.75 ± 0.15 [0.030 ± 0.006]
1	25.4 [1.000]	12.7 [0.500]	0.90 ± 0.15 [0.035 ± 0.006]
1 1/2	38.0 [1.500]	19.0 [0.750]	1.00 ± 0.20 [0.039 ± 0.008]
2	51.0 [2.000]	25.4 [1.000]	1.15 ± 0.25 [0.045 ± 0.010]

*Wall thickness will be less if tubing recovery is restricted during shrinkage.

Ordering Information

Color	Standard	Black (-0)
	Nonstandard	White (-9), red (-2), blue (-6), yellow (-4), green (-5)
Size selection	Always order the largest size that will shrink snugly over the component to be covered. Special order sizes are available upon request.	
Standard packaging	On spools.	
Ordering description**	Specify product name, size and color (for example, ZH-100 1/8-0).	

**Europe only. For supply to MIL, Def Stan and BS add -MS, -DS or -BS to ordering description.

Heat-Shrinkable, Flexible Tubing with Low Toxicity for Fire Safety Applications

Product Facts

- 2:1 shrink ratio
- Low smoke emission
- System 100 tubing



ZHTM



Heat-Shrinkable Tubing

Applications

A flexible, thick-wall, heat-shrinkable tubing to be used in conjunction with -100 molded parts and Zerohal cable to form Raychem System 100. This material exhibits excellent fire safety characteristics combined with low smoke emission and low evolution of acid gases while retaining good mechanical and fluid-resistance

properties. Used for insulation and protection of cables, harnesses, and electrical and electronic components in enclosed spaces, such as in marine applications, mass transit systems, and offshore installations, to reduce toxicity risks, or where equipment would be irreparably damaged by corrosive products of combustion.

Installation

Minimum shrink temperature: 80°C [176°F]
 Minimum full recovery temperature: 121°C [250°F]

Operating Temperature Range

-30°C to 105°C
 [-22°F to 221°F]

Specifications/Approvals

Series	Military	Agency	Industry	Raychem
ZHTM	Def. Stan. 59-97 Issue 3 Type 8	BS 4G-198 Part 3 Type 15 VG 95343 Part 5 Type L VDE 0341/Pt 9005	BR 1326A	RW-2058

Available in:	Americas	Europe	Asia Pacific
	■	■	■

Product Dimensions

ZHTM (Continued)

Size	Inside Diameter		Recovered Wall Thickness* After Heating
	Minimum Expanded as Supplied	Maximum Recovered After Heating	
3/1.5	3.0 [0.118]	1.5 [0.059]	0.70 ± 0.10 [0.028 ± 0.004]
5/2.5	5.0 [0.197]	2.5 [0.098]	0.75 ± 0.12 [0.030 ± 0.005]
8/4	8.0 [0.315]	4.0 [0.157]	0.80 ± 0.15 [0.031 ± 0.006]
12/6	12.0 [0.472]	6.0 [0.236]	0.90 ± 0.15 [0.035 ± 0.006]
18/9	18.0 [0.709]	9.0 [0.354]	1.00 ± 0.18 [0.039 ± 0.007]
24/12	24.0 [0.945]	12.0 [0.472]	1.10 ± 0.20 [0.043 ± 0.008]
40/20	40.0 [1.575]	20.0 [0.789]	1.30 ± 0.23 [0.051 ± 0.009]
50/30	50.0 [1.969]	30.0 [1.181]	1.50 ± 0.28 [0.059 ± 0.011]

*Wall thickness will be less if tubing recovery is restricted during shrinkage.

Ordering Information

Color	Standard	Black (-0)
Size selection	Always order the largest size that will shrink snugly over the component to be covered. Special order sizes are available upon request.	
Standard packaging	On spools.	
Ordering description**	Specify product name, size and color (for example, ZHTM 8/4-0).	

**Europe only. For supply to Def Stan and BS add -DS or -BS to ordering description.

Table of Contents

Overview	4-2
General Information	4-3, 4-4
Selection Tables	4-5, 4-6
Part Numbering System	4-7
Visual Selection Guide	4-8 to 4-20
Boot Adapter Selection Tables	4-21 to 4-23
Material Selection Table	4-24
Materials	
-3	Semirigid modified polyolefin
-4	Flexible polyolefin
-12	Modified fluoroelastomer
-25	Fluid-resistant modified elastomer
-25S	Fluid-resistant screened elastomer
-50	Fluid-resistant modified elastomer
-51	Chemical-resistant fluoroelastomer
-55	Flexible fluoropolymer
-71	Semirigid modified polyolefin
-100	Low-fire-hazard material
-100S	Low-fire-hazard screened material
-125	Flexible fluoropolymer
Caps	
101A011 to 094	End caps
SSC	Heat-shrinkable end caps
Boots	
202A111 to 196	Straight boot
202C611 to 663	Uniboot
202D121 to 196	Straight, lipped boot
202D211 to 299	Straight, lipped boot
202D921 to 963	Straight, lipped boot
202F211 to 274	Straight, lipped boot
202G211 to 253	Straight, lipped boot
202G611 to 653	Uniboot
202K121 to 185	Straight, lipped boot
214A011 to 052	D-subminiature, straight boot
214A311 to 352	D-subminiature, straight boot
214P009 to 037	D-subminiature, straight boot with jack screws
222A111 to 196	Right-angled boot
222D121 to 196	Right-angled, lipped boot
222D211 to 299	Right-angled, lipped boot
222D921 to 963	Right-angled, lipped boot
222F211 to 285	Right-angled, lipped boot
222K121 to 185	Right-angled, lipped boot
234A011 to 071	D-subminiature, right-angled boot
234A111 to 152	D-subminiature, side-entry boot
234A611 to 671	D-subminiature, 90° end-entry boot
242W042 to 63	45° angled boot
Feedthroughs	
207W213 to 256	Two-part feedthrough
Transitions	
301A011 to 048	T transition
301A511 to 514	Slimline T transition
322A112 to 158	T transition
342A012 to 058	45° side-breakout transition
362A014 to 114	30° side-breakout transition
381A301 to 304	Slimline Y transition
382A012 to 046	Y transition
382C312, 322 & 332	Slimline Y transition
462A011 to 060	Transition, one to three cables
462A421 to 424	Slimline transition, one to three cables
562A011 to 067	Transition, one to four cables
QFT	Configurable heat-shrink transition
SSB, T, F to 8S	Chem-X Heavy Duty Breakout Boots

Note: Users should independently evaluate the suitability of the product for their application. Before ordering, check with Tyco Electronics for most current data.

Table of Contents (Continued)

Accessories	
202W302 to 342	Heat-shrink bobbins 4-91, 4-92
400W242	Heat-shrink positioning ring 4-93, 4-94
CES	Heat-shrinkable cable entry seals 4-95 to 4-98
RayOLOn Kits	Roll-on sealing sleeve 4-99, 4-100
shrinkHOoP	Cable clamp heat-shrink grommet 4-101 to 4-103
XL Products	Conversion Table 4-104, 4-105

Overview

Raychem heat-shrinkable molded parts, with adhesive coating, form a watertight seal, protecting cables and equipment from corrosion and mechanical abuse while providing excellent electrical insulating properties. Meeting requirements for most mass-transit, military, and commercial marine applications, Raychem molded parts include:

- Raychem SSC end caps, which provide optimum waterproofing and environmental protection for underwater, underground, or outdoor applications. The end caps are highly resistant to moisture, fungus, and weathering.
- Raychem heat-shrinkable boots and transitions, which replace tapes, mold-in-place epoxies, and grease. These molded parts can be used for cable breakouts, transitions, and terminations. For example, they provide reliable sealing to specific altitudes on standard Navy cable jackets and on lead, steel, aluminum, copper, and most elastomeric insulation materials.

All of these molded parts fit a wide variety of applications.

To select the right part for your application, follow these steps:

- Select the necessary shape.
- Match the shape with the appropriate material.
- Select a compatible adhesive, if needed, to provide additional environmental protection. Adhesives come either preinstalled or as separate components (see Section 5).

Also available is an extensive line of adapters (see Section 6) and heat-shrinkable tubings (see Section 3) to further integrate and strengthen harness assemblies.

Whatever your application, Raychem molded parts almost always meet the performance characteristics you require, including operation in low- and high-temperature environments; mechanical strength; resistance to fluids, flame, and mechanical abuse; environmental sealing; and strain relief.



Bulbous Molded Parts

Raychem bulbous-shaped molded parts provide rugged mechanical and environmental protection, meet numerous specifications, and have been used successfully in military wire and cable harnesses for more than 30 years.

Most connector strain relief boots come in two versions:

- With an adapter lip molded into the "H" end, which locks into the groove on the backshell adapter (part number is identified with a "D" or "K").
- Without the adapter lip (the boot may be installed directly on the rear of connector threads 12 mm [.472] long or longer). This part number is identified with an "A."

Many other optional features are available, such as molding ports and drain holes. For other modifications and custom shapes, please contact Tyco Electronics.

Modifications

Certain variations of the standard shapes, such as shorter leg lengths or specific over expansions, are possible. Modifications must be requested prior to your order, for feasibility.

Molding Port Modifications (-00)

Some specifications call for potting the molded shape with sealant to provide additional protection from moisture. Most of the bulbous boots and transitions can be ordered with molding ports for this purpose.

Drain Hole Modification (-88)

Some specifications require drain holes in the molded part to provide an exit for condensation. Drain holes must be requested when you place your order.

Specials

Complete design, tooling, and production of custom molded shapes and special adaptations are also possible. Estimates are made upon request.

General Information (Continued)**Breakout Boots**

Heavy-duty breakouts provide mechanical strain relief and environmental sealing for power cables where the cable jacket is cut back and conductors broken out.

These boots are used widely in ship building and meet the requirements of the following:

- Lloyd's Register of Shipping
- Det Norske Veritas (DNV)
- American Bureau of Shipping (ABS)
- DOD-STD-2003
- MIL-I-81765/1A

**Cable End Caps**

Heat-shrinkable end caps provide a reliable method of sealing power cables, pipes, conduit, and other cylindrical objects against corrosion and moisture penetration.









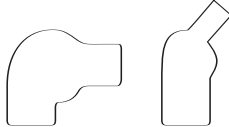

**Slim-Line Molded Parts**

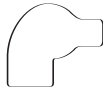
With their low profile, these flexible molded parts conform to cables better and create less bulk at transition points and connectors than bulbous molded parts.







Raychem molded parts are available in a variety of slim-line shapes, including straight and right-angle boots as well as transitions. A small family of parts can provide a wide variety of expansions (under expansion, over expansion, cut-off). Modifications are easily provided.

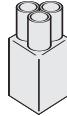

Boots

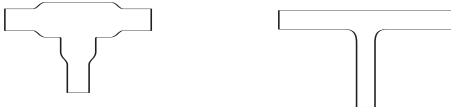
Application	Family Description	Typical Shapes	
Lipped boots for use with a circular adapter	202D121 to 196 222D121 to 196 202K121 to 185 222K121 to 185 242W042 to 063		
Nonlipped boots for use directly on a circular connector	202A111 to 196 222A111 to 196		
Low-profile lipped boots for use with a circular adapter	202D211 to 299 222D211 to 299 202F211 to 274 222F211 to 285 202G211 to 253		
Lipped boots for use with a circular adapter	202D921 to 963 222D921 to 963		
Lipped boots with compressible design for use with a circular adapter	202C611 to 663 202G611 to 653		
Adapter boots for use with D-subminiature connectors	214A011 to 052 234A011 to 071 214A311 to 352 234A111 to 152 234A611 to 671		

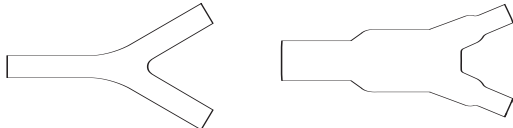
Transitions

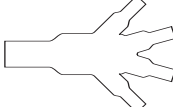
Application	Family Description	Typical Shapes			
Breakout Boots	SSB, T, F, 6S, 85				
"T" Transitions	301A011 to 048 301A511 to 514 322A112 to 158				
45° Transitions	342A012 to 058				
30° Transitions	362A014 to 114				
"Y" Transitions	381A301 to 304 382A012 to 046				
3:1 Transitions	462A011 to 060 462A421 to 424				
4:1 Transitions	562A011 to 067				

Shape Selection:
Other Products

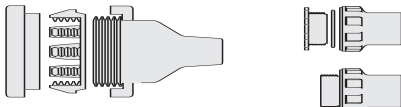
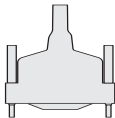
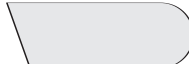
Application	Family Description	Typical Shapes	
Feedthroughs	207W213 to 256 and CES		
D-Subminiatures	214P009 to 037		
End Caps	101A011 to 094 and SSC		

2 0 2D 1 21 - 3 - 01 / 42 - 0

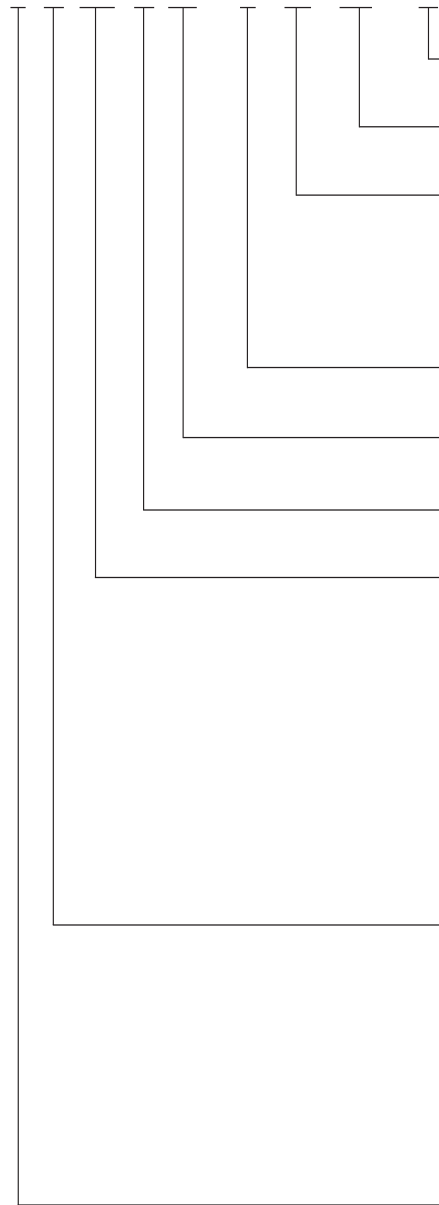

Color (TD-0 = Black). Other colors factory quote

Optional Adhesive* Coating (precoated in factory)

Modification (available on request)

- Over expansion
- Cutoff
- Molding ports (injection and vent)

Material**

Size of Part in Family: From 11 (= smallest) to 99 (= largest)

Family Number

Type of Part:

- A = Nonlipped boots/transitions
- C = Lipped boot
- D = Lipped boot
- F = Lipped boot
- K = Lipped boot
- S = Rayaten
- G = Lipped boot
- W, P = Other shapes

Angle of Part:

All openings	One opening
Circular	Noncircular
0 = Straight	0 = Straight
2 = 90°	3 = 90°
4 = 45°	5 = 45°
6 = 30°	7 = 30°

Number of openings in the part

*See section 5 for details on adhesives.
**See page 4-24 for details on materials.

Boots:
Circular Connectors —
Lipped

Lipped Boots for Use
With an Adapter

As supplied	
After recovery	
	202D121 through 196 202D211 through 299 202D921 through 963 202K121 through 185
As supplied	
After recovery	
	222B012 through 063 222B112 and 123 222D121 through 196 222D211 through 299
As supplied	
After recovery	
	222D921 through 963 202K121 through 185 242 A312 and 322 222K121

Boots:
Circular Connectors —
Nonlipped

Nonlipped Boots for Direct
Attachment on Connectors

As supplied					
After recovery					
	202A011 through 096	202A111 through 196	202A212 through 264	202A312 through 364	202A512
As supplied					
After recovery					
	202A915	202A921	202B422 and 433	203A021	
As supplied					
After recovery					
	203A211	203A312	204A011	204A311	
As supplied					
After recovery					
	204A411	204A511	204A612	208A011 through 098	222A011 through 096

Boots:
Circular Connectors —
Nonlipped (Continued)







































Nonlipped Boots for Direct
Attachment on Connectors

As supplied					
After recovery					
	222A111 through 196	222A213 through 255	222A313 through 355	223A213 through 233	224A012
As supplied					
After recovery					
	226A045 & 075	228A011 through 097	242A142	243A012 & 022	246A166
As supplied					
After recovery					
	202B521 through 598				

Boots: Circular
Connectors—Slim-Line

As supplied					
After recovery					
	202C611 through 633 202G621 through 653	202E334 through 346	202F211 through 274 202G211 through 253	222F211 through 285	







































Boots: Rectangular Connectors

As supplied					
After recovery					
	211A012	214A011 through 052	214A124 and 133	214A311 through 352	214A452
As supplied					
After recovery					
	214A511 thru 552	214A613	214A814	214A923	214B623
As supplied					
After recovery					
	214B713	234A011 through 071	234A111 through 152	234A313 through 333	234A413 through 434
As supplied					
After recovery					
	234A611 through 671	234A711 through 752	234A911 through 971	234B011 through 052	

Transitions: Bulbous

As supplied					
After recovery					
	301A011 through 048	302A012 through 037	302A214	322A012 through 037	322A112 through 158
As supplied					
After recovery					
	322A315	322A412 through 434	322A514	322B813	
As supplied					
After recovery					
	323A211	323A222	341A015	342A012 through 058	
As supplied					
After recovery					
	342A112 through 138	342A215	342A313 and 323	343A014 through 027	362A014 through 114

Transitions: Bulbous
(Continued)

As supplied					
After recovery					
	363A018 and 020	381A015	381A115	382A012 through 046	402A013
As supplied					
After recovery					
	403A123 through 155	413A013 and 024	422A011	422A114	422A414
As supplied					
After recovery					
	422A616	422A716	422A813	423A014	423A117
As supplied					
After recovery					
	453A017	453A215 and 225	462A011 through 060	462A214	

Transitions: Bulbous
(Continued)

As supplied



After recovery



502A516

502A812 through 845

522A013

561A017

As supplied



After recovery



562A011 through 067

602A012

602A022

602A114

602A212

As supplied



After recovery



622A014

703A155

704A011 and 012

902A014

Transitions: Slim-Line

As supplied



After recovery



































301A511 through 514

381A301 through 304

462A421 through 424

Covers

As supplied					
After recovery					
	102A911	102A951	102A961	102A962	102A981
As supplied					
After recovery					
	102A992	102A993	102A994	202A817	
As supplied					
After recovery					
	220A012 through 023	234A211	234B111 and 122	254A015	301A212 301A222, 302A312
As supplied					
After recovery					
	302A734	401A112 and 402A212			

Covers (Continued)

As supplied



After recovery



401A212 and 403A312 401A414 402A222 403A016 501A012 and 502A212

As supplied



After recovery



501A112 601A012

Sleeves

As supplied



After recovery



200A413 and 200A426 200D944 thru 988

As supplied



After recovery



201A711 through 792 202B211 through 302 (Not heat-shrinkable) 202B811 through 832

As supplied



After recovery



207W213 through 264 with A-type nut 207W213-x-01 through 264-x-01 with B-type nut

Caps

As supplied



After recovery



101A011 thru 094 102A811 through 865

Miscellaneous



204A711 and 002A011
Riser and Plug
(Not heat-shrinkable)

Selected Molded Shapes Families

As supplied

After recovery



202A111 through 196 Nonlipped boot

















As supplied

After recovery



202D121 through 196 Lipped boot

Selected Molded Shapes Families (Continued)

As supplied		
After recovery		
	202A212 through 264 Nonlipped boot	202D211 through 299 Lipped boot
As supplied		
After recovery		
	202D921 through 963 Lipped boot	202K121 through 185 Lipped boot
As supplied		
After recovery		
	207W213 through 264 Feedthrough	214A011 through 052 Rectangular boot
As supplied		
After recovery		
	222A111 through 196 90° boot nonlipped	222A213 through 255 90° boot nonlipped

Selected Molded Shapes Families (Continued)

As supplied



After recovery



222A313 through 355 90° boot nonlipped

222D121 through 196 90° boot lipped

As supplied

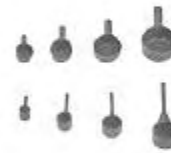

After recovery



222D211 through 299 90° boot lipped

222D921 through 963 90° boot lipped

As supplied



After recovery



222K121 through 185 90° boot lipped

301A011 through 048 T transition

Boot Adapter Selection Tables

Table 1. Boots

Boot Type	Material Dash Number	Part No.	Dimensions		Fits Adapter Order Number			
			Cable Diameter Range	Length	Solid	Spin Coupling	Entry Size Shielded	Tinel-Lock
Uni-boot	50, 51 71	202C611	4.83-9.65 [.19-.38]	120.65 [4.75]	—	—	04	04
		202C621	8.13-16.26 [.32-.64]	133.35 [5.25]	12	12-14	06-08	04-07
		202C632	12.70-25.40 [.50-1.00]	146.05 [5.75]	14-16	16-18	10-14	10-16
		202C642	17.53-35.05 [.69-1.38]	158.75 [6.25]	18-20	20	12-18	12-18
		202C653	22.35-44.20 [.88-1.74]	171.45 [6.75]	22-32	22-32	18-20	16-20
		202C663	22.86-55.63 [.90-2.19]	236.22 [9.30]	24, 28, 31	32, 36	—	—
	55	202G621	8.13-16.26 [.32-.64]	133.86 [5.27]	12-14	12-14	06-08	04-07
		202G632	12.70-25.40 [.50-1.00]	151.13 [5.95]	16	16-18	10-14	08-12
		202G642	17.53-35.05 [.69-1.38]	157.23 [6.19]	18-20	20	12-18	12-18
		202G653	22.35-44.20 [.88-1.74]	170.18 [6.70]	22-32	22-32	18-20	16-22
		—	—	—	16-24, 61	22-28, 61	—	—
		—	—	—	—	—	—	—
Low-profile, Straight	50, 51 71	202F211	6.60-15.75 [.26-.62]	105.16 [4.14]	10	08-10	04-07	04-07
		202F221	7.62-19.30 [.30-.76]	123.95 [4.88]	12-14	12-14	07-10	05-08
		202F232	8.89-22.86 [.35-.90]	146.30 [5.76]	16	16-18	10-14	08-12
		202F242	10.16-27.18 [.40-1.07]	172.21 [6.78]	18-20	20	12-18	12-16
		202F253	10.92-29.97 [.43-1.18]	185.16 [7.29]	22	22	18-20	16-18
		202F263	12.70-36.83 [.50-1.45]	213.61 [8.41]	24-28	24-28	20	18-20
	55	202F274	14.99-42.93 [.59-1.69]	203.20 [8.00]	24	32	—	—
		202G221	7.62-19.30 [.30-.76]	121.16 [4.77]	12-14	12-14	07-10	05-08
		202G232	8.89-22.86 [.35-.90]	138.68 [5.46]	16	16-18	10-14	10-12
		202G242	10.16-27.18 [.40-1.07]	159.51 [6.28]	18-20	20	14-18	12-16
		202G253	10.92-29.97 [.43-1.18]	177.80 [7.00]	22-28	22-24	16-20	16-18
		—	—	—	16-20	20-24	—	—
Low-profile, 90°	50, 51	222F211	6.60-15.75 [.26-.62]	105.16 [4.14]	10	08-10	04-07	04-07
		222F221	7.62-20.83 [.30-.82]	123.95 [4.88]	12-14	12-14	07-10	05-10
		222F232	8.89-22.86 [.35-.90]	146.30 [5.76]	16	16-18	10-14	08-12
		222F242	10.16-27.18 [.40-1.07]	172.21 [6.78]	18-20	20	12-18	12-16
	71	222F253	10.92-29.97 [.43-1.18]	185.16 [7.29]	22	22	18, 20	16-18
		222F263	12.70-36.83 [.50-1.45]	213.61 [8.41]	24-28	24-28	20	18, 20
		222F274	14.99-42.43 [.59-1.69]	224.54 [8.84]	24	32	—	—
		222F285	17.53-61.21 [.69-2.41]	227.33 [8.95]	24-32	32-40	—	—

(continued on next page)

Table 1. Boots (Continued)

Boot Type	Material Dash Number	Part No.	Dimensions		Fits Adapter Order Number			
			Cable Diameter Range	Length	Solid	Spin Coupling	Entry Size Shielded	Tinel-Lock
Low-profile, Straight	3,4,25	202D211	6.60-15.75 [26-.62]	105.92 [4.17]	08	08-10	06-07	04-07
		202D221	7.62-19.30 [30-.76]	121.16 [4.77]	08-10	08-10	08	06-07
		202D232	8.89-22.86 [35-.90]	138.68 [5.46]	10-12	10-12	10-12	08-10
		202D242	10.16-27.18 [40-1.07]	159.51 [6.28]	12-14	12-14	12-14	10-12
		202D253	10.92-29.97 [43-1.18]	177.80 [7.00]	16-18	16-18	16-18	14-16
		202D263	12.70-36.83 [50-1.45]	203.20 [8.00]	20-22	20-22	18-20	18-20
		202D274	14.99-42.93 [59-1.69]	203.20 [8.00]	24	28	22-24	22-24
		202D285	18.29-55.88 [72-2.20]	203.20 [8.00]	28	32-34	28	—
		202D296	20.07-59.69 [79-2.35]	203.20 [8.00]	—	40	—	—
		202D299	23.37-72.39 [92-2.85]	203.20 [8.00]	—	44	—	—
Low-profile, 90°	3,4,25	222D211	6.60-15.75 [26-.62]	105.16 [4.14]	08	08-10	06-07	04-07
		222D221	7.62-19.30 [30-.76]	123.95 [4.88]	08-10	08-10	08	06-08
		222D232	8.89-22.86 [35-.90]	146.30 [5.76]	10-12	10-12	10-12	08-10
		222D242	10.16-27.18 [40-1.07]	172.21 [6.78]	12-14	12-14	12-14	10-12
		222D253	10.92-29.97 [43-1.18]	185.16 [7.29]	16-18	16-18	16-18	14-16
		222D263	12.70-36.83 [50-1.45]	213.61 [8.41]	20-22	20-22	18-20	18-20
		222D274	14.99-42.93 [59-1.69]	224.54 [8.84]	24	28	22-24	22-24
		222D285	18.29-55.88 [72-2.20]	227.33 [8.95]	28	32-34	28	—
		222D296	20.07-59.69 [79-2.35]	233.43 [9.19]	—	40	—	—
		222D299	23.37-72.39 [92-2.85]	203.20 [8.00]	—	44	—	—
Bulbous, Straight	3,4,25	202D121	6.10-19.05 [24-.75]	38.10 [1.50]	—	08	04-05	04-07
		202D132	7.11-23.37 [28-.92]	54.86 [2.16]	08	10	06-07	06-08
		202D142	7.62-25.15 [30-.99]	66.80 [2.63]	10	12-14	09-10	07-10
		202D153	8.89-30.48 [35-1.20]	80.10 [3.15]	12-14	16-18	11-14	10-12
		202D163	10.41-34.29 [41-1.35]	103.63 [4.08]	16-18	20-22	15-16	14-16
		202D174	10.41-34.29 [41-1.35]	103.63 [4.08]	16-18	20-22	15-16	14-16
		202D185	20.83-53.34 [82-2.10]	165.10 [6.50]	—	—	24	24
		202D196	25.91-69.85 [102-2.75]	177.80 [7.00]	—	—	—	—
		202K121	6.10-19.05 [24-.75]	38.10 [1.50]	—	08	04-05	04-07
		202K132	7.11-23.37 [28-.92]	54.86 [2.16]	08	10	06-07	06-08
		202K142	7.62-25.15 [30-.99]	66.80 [2.63]	10	12-14	09-10	07-10
		202K153	8.89-30.48 [35-1.20]	80.10 [3.15]	12-14	16-18	11-14	10-12
		202K163	10.41-34.29 [41-1.35]	103.63 [4.08]	16-18	20-22	15-16	14-16
		202K174	10.41-34.29 [41-1.35]	103.63 [4.08]	16-18	20-22	15-16	14-16
		202K185	20.83-53.34 [82-2.10]	165.10 [6.50]	—	—	24	24
		222D121	6.10-19.05 [24-.75]	21.34 [0.84]	—	08	04-05	04-07
		222D132	7.11-23.37 [28-.92]	33.78 [1.33]	08	10	06-07	05-08
		222D142	7.62-25.15 [30-.99]	36.58 [1.44]	10	12-14	09-10	08-10
222D153	8.89-30.48 [35-1.20]	43.69 [1.72]	12-14	16-18	11-14	10-14		
222D163	10.41-34.29 [41-1.35]	53.59 [2.11]	16-18	20-22	15-16	14-18		
222D174	16.26-44.96 [64-1.77]	77.98 [3.07]	20-24	24	18-22	18-22		
222D185	20.83-53.34 [82-2.10]	97.54 [3.84]	—	—	24	24		
222D196	25.91-69.85 [102-2.75]	117.86 [4.64]	—	—	—	—		
222K121	6.10-19.05 [24-.75]	21.34 [0.84]	—	08	04-05	04-07		
222K132	7.11-23.37 [28-.92]	33.78 [1.33]	08	10	06-07	05-08		
222K142	7.62-25.15 [30-.99]	36.58 [1.44]	10	12-14	09-10	08-10		
222K153	8.89-30.48 [35-1.20]	43.69 [1.72]	12-14	16-18	11-14	10-14		
222K163	10.41-34.29 [41-1.35]	53.59 [2.11]	16-18	20-22	15-16	14-18		
222K174	16.26-44.96 [64-1.77]	77.98 [3.07]	20-24	24	18-22	18-22		
222K185	20.83-53.34 [82-2.10]	97.54 [3.84]	—	—	24	24		

Note: 202KXXX and 222KXXX parts Europe only.

Boot Adapter Selection Tables (Continued)

Table 2. Shims

Part No.	Cable Diameter Range	Shim Boot or Tubing
202C611	3.81-4.83 [.15-.19]	Tubing
202C621	6.35-8.13 [.25-.32]	Tubing
202C632	9.65-12.70 [.38-.50]	Tubing
202C632	3.30-9.65 [.13-.38]	202E334
202C632	14.48-17.53 [.57-.69]	Tubing
202C642	9.91-14.48 [.39-.57]	202E346
202C642	3.30-9.65 [.13-.38]	202E344
202C642	19.30-22.35 [.76-.88]	Tubing
202C653	9.91-19.30 [.39-.76]	202E346
202C653	3.30-9.65 [.13-.38]	202E344
202C658	17.53-22.86 [.69-.90]	Tubing
202C663	17.53-22.86 [.69-.90]	Tubing
202D211/202F211	5.08-6.60 [.20-.26]	Tubing
222D211/222F211	5.08-6.60 [.20-.26]	Tubing
202D221/202F221	5.84-7.62 [.23-.30]	Tubing
222D221/222F221	5.84-7.62 [.23-.30]	Tubing
202D221/202F221	5.92 [.233]	Tubing
222D221/222F221	5.92 [.233]	Tubing
202D232/202F232	6.86-8.89 [.27-.35]	Tubing
222D232/222F232	6.86-8.89 [.27-.35]	Tubing
202D242/202F242	7.87-10.16 [.31-.40]	Tubing
222D242/222F242	3.30-7.87 [.13-.31]	202E334
202D253/202F253	8.38-10.92 [.33-.43]	Tubing
222D253/222F253	3.30-8.38 [.13-.33]	202E334
202D263/202F263	9.65-12.70 [.38-.50]	Tubing
222D263/222F263	3.30-9.65 [.13-.38]	202E334
202D274/202F274	11.43-14.99 [.45-.59]	Tubing
222D274/222F274	9.91-11.43 [.39-.45]	202E346
222D274/222F274	3.30-9.65 [.13-.38]	202E344
222D274/222F274	13.46-17.53 [.53-.69]	Tubing
222D285/222F285	9.91-13.46 [.39-.53]	202E346
222D285/222F285	3.30-9.65 [.13-.38]	202E344
222D1XDU222D1XX	—	Use tubing as a shim if necessary

Material Selection Table

Applications

Tyco Electronics offers Raychem products in a variety of materials to enable designers and material specifiers to obtain optimum performance.

Material*	Characteristics
-3 Molded Part Material	A general purpose, heat-shrinkable semi rigid and flame retarded polyolefin molding compound with good resistance to fluids and heat. -3 molded parts are ideal for use in applications where toughness combined with resistance to occasional exposure to fluids or heat is required. -3 molded parts are recommended for use in System 10.
-3S Molded Part Material	A general purpose, heat-shrinkable flame retarded, polyolefin compound used to make shielded molded parts.-3S molded parts form part of the Rayaten shielding system and are ideal for use in applications where toughness combined with resistance to occasional exposure to fluids or heat is required. -3S molded parts are recommended for use in System 10.
-4 Molded Part Material	A general purpose, heat-shrinkable flexible and flame retarded polyolefin molding compound with good resistance to fluids and heat. -4 molded parts are ideal for use in applications where toughness combined with resistance to occasional exposure to fluids or heat is required. -4 molded parts are recommended for use in System 10.
-6 Molded Part Material	Designed for use in applications where extreme flexibility is required. The parts provide excellent strain relief and sealing over a broad temperature range and remain flexible at very low temperatures. The standard color is black.
-8 Molded Part Material	For use in outer space, where use of low outgassing components is required. The parts provide excellent strain relief at connector cable terminations. Please contact Raychem for available shapes. The standard color is black.
-12 Molded Part Material	A high temperature, heat-shrinkable, flexible, flame retarded, fluoroelastomeric molding compound with excellent resistance to long term fluid immersion and heat exposure. A wide range of shapes are available in this material. -12 molded parts are recommended for use in System 200.
-25 Molded Part Material	A heat-shrinkable, semi rigid, fluid and temperature resistant, elastomeric molding compound, designed to offer excellent performance in harsh environments. Ideal for use in military vehicles where high temperatures and long term exposure to hot fluids is expected. A wide range of shapes are available in this material. -25 molded parts are recommended for use in System 25.
-25S Molded Part Material	A heat-shrinkable, semi rigid, fluid and temperature resistant, elastomeric compound, used to make shielded molded parts. -25S molded parts form part of the Rayaten shielding system and are ideal for use in military vehicles where high temperatures and long term exposure to hot fluids is expected. -25S molded parts are recommended for use in System 25.
-50 Molded Part Material	A heat-shrinkable, highly flexible, fluid and temperature resistant, VPB molding compound, ideal for use in general purpose and high temperature military applications where exposure to petroleum based solvents is expected. Uniboosts and a wide range of low profile shapes are available in this material. -50 molded parts are recommended for use in System 30.
-51 Molded Part Material	A heat-shrinkable, rugged, flexible, fluid and temperature resistant, EPB molding compound, ideal for use in general purpose applications where exposure to petroleum based solvents is expected. Uniboosts and a wide range of low profile shapes are available in this material. -51 molded parts are recommended for use in System 20.
-55 Molded Part Material	A heat-shrinkable, flexible, flame retarded, fluid and high temperature resistant, modified fluoropolymer molding compound. A wide range of shapes is available. -55 molded parts are recommended for use in System 300.
-71 Molded Part Material	A heat-shrinkable, flexible, fluid and temperature resistant, polyolefin molding compound, ideal for use in general purpose applications where a good balance of fluid and heat resistance properties is required. Uniboosts and a wide range of low profile shapes are available. -71 molded parts are suitable for use in System 10.
-100 Molded Part Material	A heat-shrinkable, semi flexible, low fire hazard molding compound designed to offer excellent fire safety characteristics combined with low smoke and low acid gas emission -100 also exhibits good mechanical and fluid resistance properties. A wide range of shapes are available in this material. -100 molded parts are recommended for use in System 100.
-100S Molded Part Material	A heat-shrinkable, semi flexible, low fire hazard compound used to make shielded molded parts. 100S molded parts form part of the Rayaten shielding system and are designed to offer excellent fire safety characteristics combined with low smoke and low acid gas emission. -100S also exhibits good mechanical and fluid resistance properties. -100S molded parts are recommended for use in System 100.
-125 Molded Part Material	A heat-shrinkable, flame retarded, fluid and high temperature resistant, modified fluoropolymer molding compound. A range of shapes are available. -125 molded parts are recommended for use in System 300.
-130 Molded Part Material	Non flame-retarded molded material. Low shrink temperature.
-146 Molded Part Material	Flame retarded, ultra-high ratio heat-shrinkable material.
-152 Molded Part Material	Flame retarded, high ratio heat-shrinkable material.

*Check with specific part page for applicable materials.

Semi-Rigid Modified Polyolefin

Product Facts

- Heat-shrinkable
- Semi-Rigid
- Flame Retardant
- Good resistance to fluids and heat



Applications

Raychem molded parts in -3 material are designed for use in general harnessing applications where toughness is required and systems are occasionally exposed to fluids or heat. The adhesive-lined parts provide excellent sealing and strain relief at connector-cable terminations and transitions. A wide range of shapes are available in this material. The standard color is black.

Installation

Raychem -3 molded parts will shrink on the application of heat above 125°C [257°F].
Recommended installation temperature: 150°C [302°F]

Operating Temperature Range

-55°C to 135°C
[-67°F to 275°F]

Available in:	Americas	Europe	Asia Pacific
	■	■	■

-3 (Continued)

Specifications/Approvals

 UL	Military	Raychem
224, File E85381	SAE-AS81765/1, Type I Def. Stan. 59-97 Issue 3 Type DA (Europe) BS-G-198-5-DA (Europe)	RT-301

Product Characteristics

		Specification Requirements	Test Method
Physical	Tensile strength	10.5 MPa (min.)	ISO 37; ASTM D 412
	Ultimate elongation	250% (min.)	ISO 37; ASTM D 412
	2% secant modulus	80–160 MPa	ASTM D 882
	Specific gravity	1.4 (max.)	ISO 1183; ASTM D 792
Thermal	Heat aging for 168 h at 175°C [347°F]	Ultimate elongation 150% (min.)	ISO 188, ISO 37
	Heat shock for 4 h at 225°C [437°F]	No dripping, cracking, or flowing	ASTM D 2671
	Low-temperature flex at -55°C [-67°F]	No cracking during mandrel bend	RK-6703, CL 2.7: RT-301 Sec. 4.3.4
	Flammability	Self-extinguishing	RK-6703, CL 2.8: ASTM D 635
Electrical	Electric strength	8 MV/m (min.)	IEC 243
Water absorption	—	0.5% (max.)	ISO 62
Fluid resistance	Aviation fuel F40	Tensile strength 8.5 MPa (min.) Ultimate elongation 200% (min.)	ISO 1817 and ISO 37 after immersion for 24 h at 23°C [73°F]
	Lubricating oil O-149	Tensile strength 8.5 MPa (min.) Ultimate elongation 200% (min.)	ISO 1817 and ISO 37 after immersion for 24 h at 23°C [73°F]
	Phosphate ester hydraulic fluid (DTD 900/4881A)	Tensile strength 8.5 MPa (min.) Ultimate elongation 200% (min.)	ISO 1817 and ISO 37 after immersion for 24 h at 23°C [73°F]

Flexible Polyolefin

Product Facts

- Heat-shrinkable
- Flexible
- Flame Retardant
- Good resistance to fluids and heat

-4



Applications

Raychem molded parts in -4 material are designed for use in general harnessing applications where toughness is required and systems are occasionally exposed to fluids or heat. The adhesive-lined parts provide excellent sealing and strain relief at connector-cable terminations and transitions.

A wide range of shapes are available in this material. The standard color is black.

Installation

Raychem -4 molded parts will shrink on the application of heat above 100°C [212°F].

Recommended installation temperature: 150°C [302°F]

Operating Temperature Range

-55°C to 135°C
[-67°F to 275°F]

Available in:	Americas	Europe	Asia Pacific
	■	■	■

-4 (Continued)

 UL	Military	Raychem
224, File E85381	SAE-AS81765/1, Type II	RT-1304

Product Characteristics

		Specification Requirements	Test Method
Physical	Tensile strength	1800 psi (min.)	ASTM D 412
	Ultimate elongation	400% (min.)	ASTM D 412
	Specific gravity	1.3 (max.)	ASTM D 792
Thermal	Heat aging for 168 h at 175°C [347°F]	Ultimate elongation 300% (min.)	RT 1304 Sec. 4.3.3
	Heat shock for 4 h at 225°C [437°F]	No dripping, flowing, or cracking	RT 1304 Sec. 4.3.5
	Low-temperature flex at -55°C [-67°F]	No cracking	RT 1304 Sec. 4.3.4
	Flammability (burn time)	Average flame time: 120 s (max.)	ASTM D 635
Electrical	Dielectric strength	350 V/mil (min.)	ASTM D 149
Water absorption	—	0.3% (max.)	ASTM D 570
Fluid resistance	JP-4 fuel, aviation gasoline, water, hydraulic fluid	Tensile strength 8.5 MPa psi (min.) Ultimate elongation 200% (min.)	RT-1304 Sec. 4.3.3

Modified Fluoroelastomer

Product Facts

- Heat-shrinkable, flexible, fluid-resistant modified fluoro-elastomer
- Excellent resistance to long-term fuel immersion



Applications

Raychem -12 molded parts with Viton® fluoroelastomers are designed to be used in conjunction with tubing made from Viton® fluoro-elastomers or multi-conductor cable jackets and a suitable adhesive in Raychem System 200. This system provides excellent resistance to elevated temperatures and continuous fuel immersion. Available in a wide range of configurations, -12 molded parts will operate from -55°C [-67°F] to 200°C [392°F]. The standard color is black.

Installation

Raychem -12 molded parts will shrink on the application of heat above 175°C [347°F].
Recommended installation temperature: 220°C [428°F]

Operating Temperature Range

-55°C to 200°C
[-67°F to 392°F]

VITON is a trademark of Dupont Dow Elastomers LLC.

Available in:	Americas	Europe	Asia Pacific
	■	■	■

Catalog 1654025
Revised 12-04

www.tycoelectronics.com

Dimensions are in millimeters and inches unless otherwise specified. Values in brackets are U.S. equivalents.

Dimensions are shown for reference purposes only. Specifications subject to change.

USA: 1-800-522-6752
Canada: 1-905-470-4425
Mexico: 01-800-733-8926
C. America: 52-55-5-729-0425

South America: 55-11-3611-1514
Japan: 81-44-900-5102
Singapore: 65-4866-151
UK: 44-1793-528171

-12 (Continued)

Specifications/Approvals

Military	Raychem
SAE-AS81765/4	RT-1312
Def. Stan. 59-97 Issue 3 Type DD (Europe)	—
BS-G-198-5-DD-P (Europe)	—

Product Characteristics

		Specification Requirements	Test Method
Physical	Tensile strength	12.4 MPa (min.)	ISO 37
	Ultimate elongation	300% (min.)	ISO 37
	2% secant modulus	70 MPa (max.)	ASTM D 882
	Specific gravity	1.95 (max.)	ISO 1183
Thermal	Heat aging for 168 h at 250°C [482°F]	Ultimate elongation 250% (min.)	ISO 188, ISO 37
	Heat shock for 4 h at 300°C [572°F]	No dripping, cracking, or flowing	ASTM D 2671
	Low temperature flex at -55°C [-67°F]	No cracking	ASTM D 2671
	Flammability (burn time)	30 s (max.)	ASTM D 635
Electrical	Electric strength	8 MV/m (min.)	IEC 243
Water absorption	—	0.5% (max.)	ISO 62
Fluid resistance	Aviation fuel F40	Tensile strength 11 MPa (min.) Ultimate elongation 200% (min.)	ISO 1817 after immersion for 24 h at 23°C [73°F]
	Lubricating oil O-149	Tensile strength 11 MPa (min.) Ultimate elongation 200% (min.)	ISO 1817 after immersion for 24 h at 93°C [200°F]
	Hydraulic fluid H515	Tensile strength 11 MPa (min.) Ultimate elongation 200% (min.)	ISO 1817 after immersion for 24 h at 93°C [200°F]

Electronics

-25

Fluid-Resistant Modified Elastomer

Product Facts

- Heat-shrinkable, semi-rigid, chemical- and abrasion-resistant molded shapes
- Excellent resistance to high-temperature fluids
- Resistance to long-term exposure at elevated temperatures



Applications

Raychem heat-shrinkable molded parts in -25 material are designed to be used in conjunction with other System 25 components such as DR-25 tubing and S1125 adhesive, providing a complete cable harness system capability.

-25 parts have been specifically formulated and designed to provide optimum high-temperature fluid resistance and long-term heat resistance. This unique balance of properties makes -25 parts particularly suitable for sealing and strain relief at connector-cable terminations and cable-to-cable transitions on military vehicle cables and harnesses. Available in a wide range of configurations, -25 parts will operate from -75°C to 150°C [-103°F to 302°F] for long periods. The standard color is black.

Installation

Raychem -25 molded parts will shrink on the application of heat above 135°C [275°F].

Recommended installation temperature: 175°C [347°F]

Operating Temperature Range

-75°C to 150°C
[-103°F to 302°F]

Available in:	Americas	Europe	Asia Pacific
	■	■	■

Specifications/Approvals

Military	Raychem
VG95343 Parts 6, 7, 8 and 9 (Europe)	RT-1325
Def Stan 59-97, Issue 3, Type DE (Europe)	—
BSG-198-5-DE-P	—

Product Characteristics

		Specification Requirements	Test Method
Physical	Tensile strength	15 MPa (min.)	ASTM D 412
	Ultimate elongation	350% (min.)	ASTM D 412
	Specific gravity	1.5 (max.)	ASTM D 792
Thermal	Heat aging for 168 h at 150°C [302°F]	Ultimate elongation 300% (min.)	ASTM D 412
	Heat shock for 4 h at 225°C [437°F]	No dripping, cracking, or flowing	ASTM D 2671
	Low-temperature flex for 4 h at -70°C [-94°F]	No cracking during mandrel bend	ASTM D 2671
	Flammability (burn time)	120 s (max.)	ASTM D 635
Electrical	Electric strength	8 MV/m	ASTM D 149
Fluid resistance	Aviation fuel JP-4 (MIL-T-5624)	Tensile strength 12 MPa (min.) Ultimate elongation 300% (min.)	ASTM D 412 after immersion for 24 h at 25°C [77°F]
	Hydraulic fluid (MIL-H-6083)	Tensile strength 12 MPa (min.) Ultimate elongation 300% (min.)	ASTM D 412 after immersion for 24 h at 25°C [77°F]
	Diesel fuel (VV-F-800 No 2)	Tensile strength 12 MPa (min.) Ultimate elongation 300% (min.)	ASTM D 412 after immersion for 24 h at 50°C [122°F]
	Automotive gasoline (MIL-G-3056)	Tensile strength 12 MPa (min.) Ultimate elongation 300% (min.)	ASTM D 412 after immersion for 24 h at 25°C [77°F]

Fluid-Resistant Screened Elastomer

Product Facts

- Fuel and heat resistance
- RFI, EMI protection

-25S



Applications

Rayaten screened molded parts in -25S material are designed for use with FDR-25 or DR-25 jacketed screened multiconductor cable and S1125 adhesive to provide a complete high-performance harness system offering high levels of RFI and EMI protection. This -25 material provides optimum high-temperature fluid-resistance and long-term heat-aging properties. The material is particularly suitable for providing encapsulation, mechanical protection, and strain relief on terminations and cable transitions in harsh environments. The standard color is black. Products made from this material are normally used in an assembly (see section 7).

Operating Temperature Range

-55°C to 150°C
[-67°F to 302°F]

Available in:	Americas	Europe	Asia Pacific
	■	■	■

Specifications/Approvals

Military	Raychem
VG 95343 Pt. 20, Pt. 22	RK-6719

Product Characteristics

	Specification Requirements*	Screening effectiveness in dB at		
		3 KHz to 30 MHz (min.)	>30 MHz to 100 MHz (min.)	
Initial values	Tensile strength: 12 MPa (min.)	—	—	
	Ultimate elongation: 400% (min.)	—	—	
	Metal adhesion: 15 N/cm (min.)	—	—	
	Shielding effectiveness	75	70	
Thermal	Heat shock (1/2 h at 200°C [392°F])	Tensile strength: 12 MPa (min.)	—	
		Ultimate elongation: 400% (min.)	—	
		Shielding effectiveness	75	
	Heat aging (168 h at 160°C [320°F])	Tensile strength: 12 MPa (min.)	—	
		Ultimate elongation: 400% (min.)	—	
		Shielding effectiveness	75	
3 thermal cycles of -75°C to 150°C [-103°F to 302°F]	Shielding effectiveness	75	70	
Immersion in the following fluids for 24 h:	Lubricating oil (O-156, at 100°C [212°F])	Tensile strength: 10 MPa (min.)	—	
		Ultimate elongation: 300% (min.)	—	
		Shielding effectiveness	75	
	Hydraulic fluid H515, at 50°C [122°F]	Tensile strength: 10 MPa (min.)	—	
		Ultimate elongation: 300% (min.)	—	
		Shielding effectiveness	75	
	Chemical	Aviation fuel JP4 F40, at 23°C [73°F]	Tensile strength: 10 MPa (min.)	—
			Ultimate elongation: 300% (min.)	—
			Shielding effectiveness	75
		Diesel fuel F54, at 23°C [73°F]	Tensile strength: 10 MPa (min.)	—
			Ultimate elongation: 300% (min.)	—
			Shielding effectiveness	75
	1, 1, 1, trichloroethane (1 h, at 23°C [73°F])	Tensile strength: 10 MPa (min.)	—	
		Ultimate elongation: 300% (min.)	—	
		Shielding effectiveness	75	

*Values quoted are for the polymer/metal composite in all cases when terminated using epoxy adhesives.

Fluid-Resistant Modified Elastomer

Product Facts

- Excellent heat and fluid resistance
- Low profile
- Rugged
- Lightweight



Applications

A high-performance blend of Viton® and other polymers, Raychem -50 offers excellent fluid and temperature resistance. It is suitable for use in most areas of military vehicle harnessing. This material is available in the Uniboot range and should be chosen in applications that use System 30 components. The standard color is black.

Installation

Raychem -50 molded parts will shrink on the application of heat above 125°C [257°F]. Recommended installation temperature is 175°C [347°F]

Operating Temperature Range

-55°C to 150°C
[-67°F to 302°F]

VITON is a trademark of Dupont Dow Elastomers LLC.

Available in:	Americas	Europe	Asia Pacific
	■	■	■

Catalog 1654025
Revised 12-04

www.tycoelectronics.com

Dimensions are in millimeters and inches unless otherwise specified. Values in brackets are U.S. equivalents.

Dimensions are shown for reference purposes only. Specifications subject to change.

USA: 1-800-522-6752
Canada: 1-905-470-4425
Mexico: 01-800-733-8926
C. America: 52-55-5-729-0425

South America: 55-11-3611-1514
Japan: 81-44-900-5102
Singapore: 65-4866-151
UK: 44-1793-528171

Specifications/Approvals

Military	Raychem
SC-X-15111 (U.S.)	RT-1313

Product Characteristics

		Specification Requirements	Test Method
Physical	Tensile strength	15 MPa (min.)	ASTM D 412
	Ultimate elongation	350% (min.)	ASTM D 412
	Specific gravity	1.5 (max.)	ASTM D 792
Thermal	Heat aging for 168 h at 150°C [302°F]	Ultimate elongation 300% (min.)	ASTM D 412
	Heat shock for 4 h at 225°C [437°F]	No dripping, cracking, or flowing	ASTM D 2671
	Low-temperature flex for 4 h at -70°C [-94°F]	No cracking during mandrel bend	ASTM D 2671
	Flammability (burn time)	120 s (max.)	ASTM D 635
Electrical	Electric strength	8 MV/m	ASTM D 149
Fluid resistance	Aviation fuel JP-4 (MIL-T-5624)	Tensile strength 12 MPa (min.) Ultimate elongation 300% (min.)	ASTM D 412 after immersion for 24 h at 25°C [77°F]
	Hydraulic fluid (MIL-H-6083)	Tensile strength 12 MPa (min.) Ultimate elongation 300% (min.)	ASTM D 412 after immersion for 24 h at 25°C [77°F]
	Diesel fuel (VV-F-800 No 2)	Tensile strength 12 MPa (min.) Ultimate elongation 300% (min.)	ASTM D 412 after immersion for 24 h at 50°C [122°F]
	Automotive gasoline (MIL-G-3056)	Tensile strength 12 MPa (min.) Ultimate elongation 300% (min.)	ASTM D 412 after immersion for 24 h at 25°C [77°F]

Chemical-Resistant Fluoroelastomer

Product Facts

- Excellent fuel resistance
- Low profile
- Rugged
- Lightweight



4 Molded Parts



Applications

A high-performance elastomeric blend of polymers, Raychem -51 offers excellent fluid resistance.

It is suitable for use in most areas of military vehicle harnessing. This material is available in the Uniboot range and other slimline boots and transitions. The standard color is black.

Installation

Raychem -51 molded parts will shrink on the application of heat above 125°C [257°F].

Recommended installation temperature is 150°C [302°F]

Operating Temperature Range

-55°C to 135°C
[-67°F to 275°F]

Available in:	Americas	Europe	Asia Pacific
	■	■	■

Specifications/Approvals

Military	Raychem
SC-X-15112 (U.S.)	RT-1321

Product Characteristics

	Specification Requirements	Test Method
Physical	Tensile strength	1500 psi (min.)
	Ultimate elongation	300% (min.)
	Specific gravity	1.6 (max.)
Thermal	Heat aging for 168 h at 121°C [250°F]	Tensile strength 1200 psi. (min.) Elongation 250% (min.)
	Heat shock for 4 h at 200°C [392°F]	No dripping, flowing, or cracking
	Low-temperature flex for 4 h at -55°C [-67°F]	No cracking
	Flammability (burn time)	120 seconds, 1 inch (max.)
Electrical	Dielectric strength	200 V/mil (min.)
Fluid resistance	Lubricating oil, diesel oil, water for 24 h at 25°C [77°F]	Tensile strength 1000 psi (min.) Elongation 225% (min.) Weight increase 10% (max.)
	Gasoline for 24 h at 25°C [77°F]	Tensile strength 800 psi (min.) Elongation 225% (min.) Weight increase 25% (max.)
	Isopropyl alcohol, cleaning fluid for 24 h at 25°C [77°F]	Tensile strength 1400 psi (min.) Elongation 225% (min.) Weight increase 10% (max.)
	Hydraulic fluid for 24 h at 71°C [160°F]	Tensile strength 1000 psi (min.) Elongation 225% (min.) Weight increase 25% (max.)

Flexible Fluoropolymer

Product Facts

- Flame retardant
- Abrasion and cut through resistance
- Flexible
- High temperature resistance
- High fluid resistance
- Environmentally sealed



Materials

-55

Applications

A heat-shrinkable, flexible, flame retardant, fluid and high temperature resistant, modified fluoropolymer molding compound. -55 molded parts are ideal for use in applications where chemical resistance and abrasion resistance is required. A wide range of shapes are available. -55 molded parts are recommended for use in System 300.

Use the System 300 family of parts in military and industrial applications where excellent high temperature performance and good physical and chemical properties are a requirement.

System 300 jacketing is based on a modified fluoropolymer and features a one part epoxy adhesive in tape form.

Installation

This specification covers the requirements for one type of flexible, electrical insulating molded component whose expanded dimensions will reduce to a predetermined size upon the application of heat in excess of 220°C [428°F].

Operating Temperature Range

-65°C to 200°C
[-85°F to 392°F]

Specifications/Approvals

RT-1330

Product Characteristics

Physical	Tensile Strength	psi (MPa)	3500 minimum (24.1)	Section 4.3.3
	Ultimate Elongation	percent	200 minimum	ASTM D 2671
	Specific Gravity	—	2.0 maximum	ASTM D 792
	Low Temperature Flexibility 4 hours at -65 ± 2°C [-85 ± 4°F]	—	No cracking	Section 4.3.4
	Heat Shock 4 hours at 300°C [572°F]	—	No dripping, flowing or cracking	Section 4.3.5
	Heat Resistance 336 hours at 250°C [482°F]	—	—	Section 4.3.6
	Followed by tests for: Tensile Strength	psi (MPa)	2000 minimum (13.8)	Section 4.3.3
	Elongation	percent	150 minimum	ASTM D 2671

Available in:	Americas	Europe	Asia Pacific
	■	■	■

Product Characteristics (Continued)

Materials

-55 (Continued)

Electrical			
Dielectric Strength	volts/mil	200 minimum	ASTM D 149
Volume Resistivity	ohm-cm	1011 minimum	ASTM D 257
Chemical			
Corrosive Effect 16 hours at 200 ± 3°C [392 ± 5°F]	—	Noncorrosive	Section 4.3.7 ASTM D 2671 Procedure A
Flammability			
Average Time of Burning	seconds	15 maximum	ASTM D 635
Average Extent of Burning	inches (mm)	0.5 maximum (12.5)	
Fungus Resistance	—	Rating of 1 or less	ASTM G 21
Water Absorption 24 hours at 23 ± 3°C [73 ± 5°F]	percent	0.5 maximum	ASTM D 570
Fluid Resistance 24 hours at 23 ± 3°C [73 ± 5°F] in: Gasoline, Aviation Grade 100 (ASTM D 910) 1,1,1 Trichloroethane (MIL-T-81533) Coolanol 25 Followed by tests for:	—	—	Section 4.3.8
Tensile Strength	psi (MPa)	3000 minimum (20.7)	Section 4.3.3
Ultimate Elongation	percent	150 minimum	ASTM D 2671
24 hours at 50 ± 3°C [122 ± 5°F] in: JP-5 (MIL-T-5624) Deicing Fluid (MIL-A-8243) Cleaning Compound (MIL-C-43616) 5% Salt Solution (O-S-1926) Fuel Oil, Diesel (VV-F-800, DF-2) Followed by tests for:			
Tensile Strength	psi (MPa)	3000 minimum (20.7)	Section 4.3.3
Ultimate Elongation	percent	150 minimum	ASTM D 2671
24 hours at 75 ± 3°C [167 ± 5°F] in: Hydraulic Fluid (MIL-H-5606) Skydrol® 500 Lubricating Oil (MIL-L-2104) Lubricating Oil (MIL-L-7808) Followed by tests for:	—	—	Section 4.3.8
Tensile Strength	psi (MPa)	3000 minimum (20.7)	Section 4.3.3
Ultimate Elongation	percent	150 minimum	ASTM D 2671
Fluid Resistance 5 hours at 23 ± 3°C [73 ± 5°F]	—	—	Section 4.3.8
Tensile Strength	psi (MPa)	3500 minimum (24.1)	Section 4.3.3
Ultimate Elongation	Percent	150 minimum	ASTM D 2671
Nuclear			
Radiation Resistance Followed by tests for:			
Tensile Strength	psi (MPa)	3500 minimum (24.1)	—
Ultimate Elongation	percent	150 minimum	

Electronics

Semirigid Modified Polyolefin

Product Facts

- Flexible
- Flame-retardant

-71



Applications

Raychem -71 is a flexible, flame-retardant polyolefin suitable for use in general harnessing applications. The material is very flexible and offers a good balance of fluid and heat resistance. If Uniboot molded parts are required, -71 should be chosen as a replacement for -3. The standard color is black.

Installation

Raychem -71 molded parts will shrink on the application of heat above 100°C [212°F].

Recommended installation temperature is 150°C [302°F]

Operating Temperature Range

-55°C to 135°C
-67°F to 275°F]

Available in:	Americas	Europe	Asia Pacific
	■	■	■

-71 (Continued)

Military	Raychem
SAE-AS81765/1, Type I	RT-1316

Product Characteristics

		Specification Requirements	Test Method
Physical	Tensile strength	10 MPa (min.)	ASTM D 412
	Ultimate elongation	250% (min.)	ASTM D 412
	Specific gravity	1.40 (max.)	ASTM D 792
Thermal	Heat aging for 168 hr at 175°C [347°F]	Ultimate elongation 200% (min.)	ASTM D 412
	Heat shock for 4 h at 250°C [482°F]	No dripping, cracking, or flowing	ASTM D 2671
	Low-temperature flex for 4 h at -55°C [-67°F]	No cracking during mandrel bend	ASTM D 2671
	Flammability (burn time)	90 s (max.)	ASTM D 635
Electrical	Electric strength	8 MV/m	ASTM D 149
Water absorption	—	0.5% (max.)	ASTM D 570
Fluid resistance	Aviation fuel JP-4 (MIL-T-5624)	Tensile strength 5 MPa (min.) Ultimate elongation 200% (min.)	ASTM D 412 after immersion for 24 h at 25°C [77°F]
	Lubricating oil O-149 (MIL-L-7808)	Tensile strength 5 MPa (min.) Ultimate elongation 200% (min.)	ASTM D 412 after immersion for 24 h at 25°C [77°F]
	Hydraulic fluid (MIL-H-5606)	Tensile strength 5 MPa (min.) Ultimate elongation 200% (min.)	ASTM D 412 after immersion for 24 h at 25°C [77°F]
	Skydrol® 500	Tensile strength 5 MPa (min.) Ultimate elongation 200% (min.)	ASTM D 412 after immersion for 24 h at 25°C [77°F]

Low-Fire-Hazard Material

Product Facts

- Heat-shrinkable, semiflexible molded shapes for low fire hazard applications
- Low-smoke index as defined by BS G 198 Part 5
- Low-toxicity index as defined by NES 713
- High-temperature index as defined by ISO 4589-3



Applications

Raychem heat-shrinkable molded parts in -100 material form part of Raychem's System 100. The molded parts are designed for use in conjunction with Raychem Zerohal cable and tubing for applications where hazard reduction in the event of fire is crucial. The material exhibits excellent fire safety characteristics combined with low-smoke and low-acid-gas emission while retaining good mechanical and fluid-resistant properties. -100 parts with adhesive lining provide location, sealing, and strain relief of cable-connector terminations and cable-cable transitions on harnesses used where

there is a need to lower the risk (such as in marine applications, mass transit systems, and offshore installations), or where equipment would be irreparably damaged by the corrosive products of combustion. Available in a wide range of configurations, -100 parts will operate continuously from -30°C to 105°C [-22°F to 221°F]. The standard color is black.

Operating Temperature Range

-30°C to 105°C
[-22°F to 221°F]

Installation

Raychem -100 molded parts will shrink on the application of heat above 120°C [248°F].

Recommended installation temperature: 150°C [302°F]

Available in:	Americas	Europe	Asia Pacific
	■	■	■

-100 (Continued)

Specifications/Approvals

Military/NAVSEA	Raychem
5617649 (U.S.)	RT-1323
	RK-6717
Def. Stan 59-97, Issue 3, Type DF (Europe)	—
BSG 198 Part 5 Type DF (Europe)	—
BR1326 listed Class C	—

Product Characteristics

		Specification Requirements	Test Method
Physical	Tensile strength	8 MPa (min.)	ISO 37
	Ultimate elongation	200% (min.)	ISO 37
	2% secant modulus	130 MPa (max.)	ASTM D 882
	Specific gravity	1.5 (max.)	ISO 1183
Thermal	Heat aging for 168 h at 150°C [302°F]	Ultimate elongation 100% (min.)	ISO 188, ISO 37
	Heat shock for 4 h at 225°C [437°F]	No dripping, cracking, or flowing	ASTM D 2671
	Low-temperature flex at -30°C [-22°F]	No cracking during mandrel bend	ASTM D 2671
Fire safety properties	Limiting oxygen index	29 min.	ISO 4589-2
	Temperature index	250°C [482°F] (min.)	ISO 4589-3
	Flammability (burn time)	100 s (max.)	ASTM D 635
	Smoke index	20 (max.)	BSG 198 Part 5
	Toxicity index	5 (max.) per 100 g	NES 713
Electrical	Electric strength	15 MV/m (min.)	IEC 243
Water absorption	—	0.75% (max.) at 23°C [73°F] 3.5% (max.) at 70°C [158°F]	ISO 62
Fluid resistance	ISO 1817 Gasoline fuel	Tensile strength 5 MPa (min.) Ultimate elongation 150% (min.)	ISO 1817 and ISO 37 after immersion for 24 h at 23°C [73°F]
	Lubricating oil O-149	Tensile strength 5 MPa (min.) Ultimate elongation 150% (min.)	ISO 1817 and ISO 37 after immersion for 24 h at 50°C [122°F]
	Hydraulic fluid H515	Tensile strength 5 MPa (min.) Ultimate elongation 150% (min.)	ISO 1817 and ISO 37 after immersion for 24 h at 23°C [73°F]

Low-Fire-Hazard Screened Material

Product Facts

- Screened Zerohal material
- Low smoke index as defined by NES 711
- Low toxicity index as defined by NES 713
- High temperature index as defined by NES 715



Applications

-100S is the Zerohal material option in Raychem Rayaten shield (screen) termination system. This material combines the fire safety properties of -100 with the excellent EMI and RFI screening of Rayaten screened molded parts where there is a need to lower the risk.

-100S is suitable for high-performance screen terminations in areas where Raychem Zerohal materials are required.

The standard color is black. Products made from these materials are normally used in an assembly (see section 7).

Operating Temperature Range

-30°C to 105°C
[-22°F to 221°F]

Available in:	Americas	Europe	Asia Pacific
	■	■	■

-100S (Continued)

Military	Raychem
VG 95343 Pt. 20, Pt. 22	RK-6724

Product Characteristics

	Specification Requirements*	Screening Effectiveness in dB at	
		3 KHz to 30 MHz (min.)	>30 MHz to 100 MHz (min.)
Initial values	Tensile strength: 7 MPa (min.) Metal adhesion: 15 N/cm (min.) Shielding effectiveness	75	70
Thermal	Heat shock (1/2 h at 200°C [392°F])	75	70
	Heat aging (168 h at 150°C [302°F])	75	70
Fluids	Immersion in the following fluids for 24 h:		
	Phosphate ester hydraulic fluid DTD900/4881 at 23°C [73°F]	75	70
	Water at 23°C [73°F]	75	70
	Lubricating oil O-149 at 50°C [122°F]	75	70
	Transformer oil S-756 at 50°C [122°F]	75	70

*Values quoted are for the polymer/metal composite in all cases when terminated using epoxy adhesives. (Refer to section 5.)

-125

Flexible Fluoropolymer

Product Facts

- Flame retardant
- Abrasion and cut through resistance
- High temperature resistance
- High fluid resistance
- Environmentally sealed



Applications

A heat-shrinkable, flame retardant, fluid and high temperature resistant, modified fluoropolymer molding compound. A range of shapes is available. -125 molded parts are recommended for use in System 300.

Use the System 300 family of parts in military and industrial applications where excellent high temperature performance and good physical and chemical properties are a requirement.

System 300 jacketing is based on a modified fluoropolymer and features a one part epoxy adhesive in tape form.

Installation

This specification covers the requirements for one type of electrically insulating molded component whose dimensions will reduce to a predetermined size upon the application of heat in excess of 160°C ± 3°C [320°F ± 5°F].

Operating Temperature Range

-55°C to 175°C
[-67°F to 347°F]

Specifications/Approvals

RT-1334

Product Characteristics

Physical	Elastic Memory	Percent	275 minimum expansion 90 minimum retraction	Section 4.3.2
	Tensile Strength	psi (MPa)	4000 minimum (27.5)	Section 4.3.3
	Ultimate Elongation	Percent	300 minimum	ASTM D 412
	Secant Modulus	psi (MPa)	100,000 maximum (689)	Section 4.3.4 ASTM D 882
	Specific Gravity	—	1.85 maximum	ASTM D 792
	Low Temperature Flexibility 4 hours at -57 ± 3°C [-70 ± 5°F]	—	No cracking	Section 4.3.5
	Heat Shock 4 hours at 300 ± 5°C [572 ± 9°F]	—	No dripping, flowing or cracking	Section 4.3.6
	Heat Resistance 168 hours at 250 ± 5°C [482 ± 9°F] Followed by tests for:	—	—	Section 4.3.7.1
	Tensile Strength	psi (MPa)	3500 minimum (24.1)	Section 4.3.3
	Ultimate Elongation	Percent	250 minimum	Section 4.3.3 Section 4.3.7.2
	2000 hours at 150 ± 3°C [302 ± 5°F] Followed by tests for:	—	—	—
	Tensile Strength	psi (MPa)	3500 minimum (24.1)	Section 4.3.3
	Ultimate Elongation	Percent	250 minimum	Section 4.3.3

Available in:	Americas	Europe	Asia Pacific
	■	■	■

-125 (Continued)

Electrical			
Dielectric Strength	Volts/mil (kV/mm)	300 minimum (11.9)	ASTM D 149
Volume Resistivity	ohm-cm	1013 minimum	ASTM D 257
Chemical			
Corrosive Effect 16 hours at 175 ± 3°C [347 ± 5°F]	—	Noncorrosive	Section 4.3.8 ASTM D 2671 Procedure A
Flammability Initial			
Average Time of Burning	Seconds	15 maximum	ASTM D 635
Average Extent of Burning After Fluid Immersion 24 hours at 23 ± 3°C [73 ± 5°F] Gasoline, Automotive, Combat MIL-G-3056	Inches (mm)	1 maximum (25)	Section 4.3.10
Fuel Oil, Diesel VV-F-800 DF-2 Turbine Fuel, Aviation, JP-4 MIL-T-5624	Seconds Inches (mm)	30 maximum 1 maximum (25)	ASTM D 635
Average Time of Burning Average Extent of Burning			
Fungus Resistance	—	Rating of 1 or less	ASTM G 21
Water Absorption 24 hours at 23 ± 3°C [73 ± 5°F]	Percent	0.5 maximum	ASTM D 570
Fluid Resistance 24 hours at 23 ± 3°C [73 ± 5°F] Gasoline, Automotive, Combat MIL-G-3056 24 hours at 50 ± 3°C [122 ± 5°F] Fuel Oil Diesel VV-F-800 DF-2 Turbine Fuel, Aviation, JP-4 MIL-T-5624 Electrolyte 10873919 5% Salt Solution O-S-1926 Anti-Icing & Defrosting Fluid MIL-A-8243 Lube Oil, Aircraft, Synthetic MIL-L-23699 Lube Oil MIL-L-2104 Lube Oil, Aircraft, Synthetic MIL-L-7808 24 hours at 100 ± 3°C [212 ± 5°F] Hydraulic Fluid, Synthetic MIL-H-46170 4 hours at 50 ± 3°C [122 ± 5°F] Cleaning Compound PC-437 5 hours at 23 ± 3°C [73 ± 5°F] Decontaminating Agent, DS-2 MIL-D-50030 Decontaminating Agent STB MIL-D-12468 Followed by tests for:	—	—	Section 4.3.9
Tensile Strength	psi (MPa)	3000 minimum (20.7)	Section 4.3.3
Ultimate Elongation	Percent	250 minimum	Section 4.3.3
Weight Increase	Percent	3 maximum	Section 4.3.9
Adhesive Compatibility Lap Shear Strength NSM to S-1264 to DCNS	psi (kPa)	100 minimum (689)	Section 4.3.11
Nuclear			
Radiation Resistance Followed by tests for:			Section 4.3.12
Tensile Strength	psi (MPa)	4000 (27.6)	Section 4.3.3
Ultimate Elongation	Percent	250	



End Caps, 101A011 to 094

Raychem end caps provide optimum waterproofing and environmental protection for underwater, underground, or outdoor applications. The end caps are highly resistant to moisture, fungus, and weathering.

Applications

Use for protecting cables and pipes or capping unused outlets in transitions. Provides an environmental seal when used with adhesive.

As Supplied (a)



After Unrestricted Recovery (b)

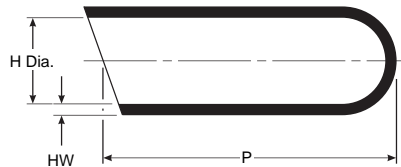

Product Dimensions

Part No.	H		P Min. b	HW ±20% b
	Min. a	Max. b		
101A011	5.10 [.20]	2.00 [.08]	22.90 [.90]	1.02 [.04]
101A021	7.40 [.29]	3.30 [.13]	25.40 [1.00]	1.27 [.05]
101A031	10.20 [.40]	4.80 [.18]	30.50 [1.20]	1.52 [.06]
101A041	15.20 [.60]	6.40 [.25]	40.60 [1.60]	1.78 [.07]
101A052	20.60 [.81]	9.40 [.37]	61.00 [2.40]	2.03 [.08]
101A062	25.40 [1.00]	11.40 [.45]	68.80 [2.70]	2.29 [.09]
101A073	39.40 [1.56]	18.00 [.71]	91.40 [3.60]	2.54 [.10]
101A083	50.80 [2.00]	22.90 [.90]	101.60 [4.00]	2.79 [.11]
101A094	83.80 [3.30]	38.10 [1.50]	114.30 [4.50]	3.05 [.12]

Note: Coating is optional. As supplied dimensions appearing in table are for uncoated parts. When coating is added, entry diameters will be reduced by 1.5 [.06] max.

Available in:	Americas	Europe	Asia Pacific
	■	■	■

End Caps, 101A011 to 094 (Continued)

Material*	Material Description	Precoating No.	Adhesive Part No.**
-3	Semirigid polyolefin	/42 or /86	S-1017 or S-1048
-4	Flexible polyolefin	/42 or /86	S-1017 or S-1048
-12	Viton®	N/A	S-1255-04
-25	Fluid-resistant elastomer	/42 or /86	S-1017 or S-1048 or S-1125
-100	Polyolefin, Zerohal	/180	S-1030

*For more information, please see the appropriate material page in this section.

**For more information, please see section 5.

VITON is a trademark of Dupont Dow
Elastomers LLC.

Heat-Shrinkable End Caps

Product Facts

- Self-sealing for waterproofing (sealant-coated parts only)
- Electrical insulation to 1000 V
- Abrasion-resistance
- Mechanical protection
- Easy installation, requiring no special skills
- Operating temperature range of -40°C to 85°C [-40°F to 185°F]
- Minimum shrink temperature of 121°C [250°F]



Applications

These SSC heat-shrinkable end caps are made from a thermally stabilized, modified polyolefin, which makes them highly resistant to moisture, fungus, and weathering. The end caps also have excellent electrical properties. End caps coated with sealant are available for underwater

or underground applications with a pressure differential up to 20 psi between the inside of the cable and the outside environment. End caps may be used over lead, steel, aluminum, copper, polyethylene, polyolefin, EPR, and PVC jacketing materials.

Available in:	Americas	Europe	Asia Pacific
	■	■	■

Specifications/Approvals

Caps

SSC (Continued)

Type	Raychem	Military/Commercial
SSC-X and SSC-XTV	SSC specification control drawing	PPS-3011/6
—	RT-1050-1	—
—	RW-2019	—
—	RW-2024	—

Caps have 1239 adhesive, Raychem Specification PPS 3012/70

Product Dimensions

Part No.	Inner Diameter* As Supplied (min.)	Part Length Recovered (max.)	Wall Thickness (nom.) Recovered ± 10 %	Recovered ± 20 %
SSC-1	10.00 [.390]	4.00 [.160]	33.50 [1.320]	2.00 [.080]
SSC-2	20.00 [.790]	7.50 [.300]	55.30 [2.180]	2.30 [.090]
SSC-3	35.00 [1.380]	15.00 [.590]	89.90 [3.540]	3.00 [.120]
SSC-4	55.00 [2.170]	25.00 [.980]	143.20 [5.640]	3.30 [.130]
SSC-5	75.00 [2.950]	32.00 [1.250]	150.10 [5.910]	3.30 [.130]
SSC-5M1	75.00 [2.950]	32.00 [1.250]	79.25 [3.120]	3.30 [.130]
SSC-6	100.00 [3.940]	45.00 [1.770]	162.50 [6.400]	4.00 [.160]
SSC-7	120.00 [4.720]	70.00 [2.760]	145.00 [5.710]	3.80 [.150]

Note: Coating is optional. As supplied dimensions appearing in table are for uncoated parts. When coating is added, entry diameters will be reduced by 1.5 [.06] max.

*Adhesive is optional. As-supplied dimensions appearing in table are for uncoated parts. When adhesive is added, entry diameters will be reduced by 1.5 [.06] maximum.

Ordering Information

Military	
SSC-XTV	Sealing end cap with adhesive
SSC-X	Sealing end cap with adhesive
SSC-XU	End cap, uncoated

Straight Boot

As Supplied (a)

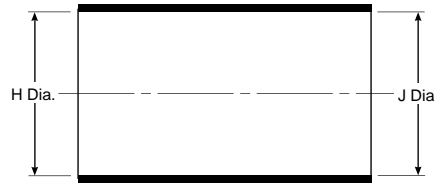

After Unrestricted Recovery (b)

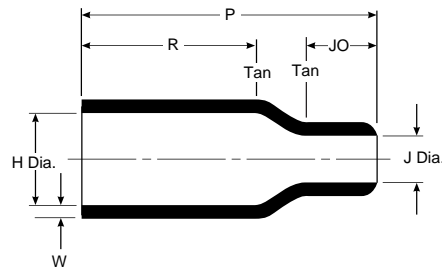

Applications

Use for mechanical protection and connector/cable strain relief. This family of boots has no lip, so that a boot can be installed directly onto the connector accessory thread.

Materials Available

Material*	Material Description	Precoating No.	Adhesive Part No.**
-3	Semirigid polyolefin	/42 or /86	S-1017 or S-1048
-4	Flexible polyolefin	/42 or /86	S-1017 or S-1048
-12	Viton®	N/A	S-1255-04
-25	Fluid-resistant elastomer	/42 or /86 or /225	S-1017 or S-1048 or S-1125
-100	Polyolefin, Zerohal	/86 or /180	S-1048 or S-1030

*For more information, please see the appropriate material page in this section.

**For more information, please see section 5.

Product Dimensions

Part No.	H			J			P ±10% b	R ±10% b	JO Ref. b	W ±20% b
	Min.		Max. b	Min.		Max. b				
	-3, -4, -25 a	-12, -100 a		-3, -4, -25 a	-12, -100 a					
202A111	16.5 [.65]	16.5 [.65]	7.9 [.31]	16.5 [.65]	11.9 [.47]	3.8 [.15]	25.4 [1.00]	14.2 [.56]	5.8 [.23]	1.27 [.05]
202A121	24.6 [.97]	22.6 [.89]	9.9 [.39]	24.6 [.97]	17.8 [.70]	5.3 [.21]	38.1 [1.50]	21.8 [.86]	9.1 [.36]	1.52 [.06]
202A132	28.4 [1.12]	26.2 [1.03]	14.2 [.56]	28.4 [1.12]	20.3 [.80]	6.6 [.26]	51.3 [2.02]	27.9 [1.10]	13.0 [.51]	1.78 [.07]
202A142	31.0 [1.22]	31.0 [1.22]	17.8 [.70]	31.0 [1.22]	25.4 [1.00]	7.4 [.29]	66.8 [2.63]	35.6 [1.40]	17.8 [.70]	1.78 [.07]
202A153	36.1 [1.42]	36.1 [1.42]	21.9 [.86]	36.1 [1.42]	26.2 [1.03]	8.6 [.34]	73.7 [2.90]	41.4 [1.63]	16.0 [.63]	1.78 [.07]
202A163	42.7 [1.68]	42.7 [1.68]	27.4 [1.08]	42.7 [1.68]	27.2 [1.07]	9.4 [.37]	99.1 [3.90]	62.7 [2.47]	18.0 [.71]	2.03 [.08]
202A174	51.8 [2.04]	48.3 [1.90]	35.3 [1.39]	51.8 [2.04]	48.3 [1.90]	16.0 [.63]	130.0 [5.13]	64.8 [2.55]	41.9 [1.65]	3.30 [.13]
202A185	66.0 [2.60]	66.0 [2.60]	43.7 [1.72]	66.0 [2.60]	54.1 [2.13]	19.6 [.77]	161.3 [6.35]	90.2 [3.55]	47.8 [1.88]	3.81 [.15]
202A196	86.4 [3.40]	86.4 [3.40]	57.2 [2.25]	86.4 [3.40]	71.4 [2.81]	26.9 [1.06]	212.6 [8.37]	113.0 [4.45]	62.2 [2.45]	4.06 [.16]

Note: Coating is optional. As supplied dimensions appearing in table are for uncoated parts. When coating is added, entry diameters will be reduced by 1.5 [.06] max.

VITON is a trademark of Dupont Dow Elastomers LLC.

Available in:	Americas	Europe	Asia Pacific
	■	■	■

Catalog 1654025
Revised 12-04

www.tycoelectronics.com

Dimensions are in millimeters and inches unless otherwise specified. Values in brackets are U.S. equivalents.

Dimensions are shown for reference purposes only. Specifications subject to change.

USA: 1-800-522-6752
Canada: 1-905-470-4425
Mexico: 01-800-733-8926
C. America: 52-55-5-729-0425

South America: 55-11-3611-1514
Japan: 81-44-900-5102
Singapore: 65-4866-151
UK: 44-1793-528171

Uniboot

As Supplied (a)



After Unrestricted Recovery (b)

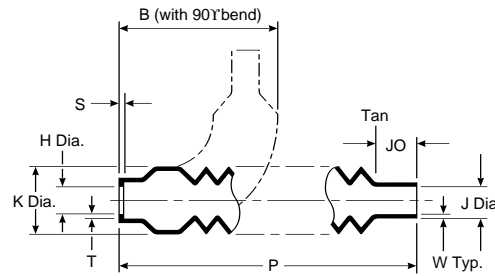

Applications

Use to provide abrasion protection for connectors. The flexibility of design allows a variety of cable outlet angles. When installed on a spin-coupling adapter, cold reentry to the

connector is possible by compressing the molded part. When used with adhesive it provides environmental sealing.

Materials Available

Material*	Material Description	Precoating No.	Adhesive Part No.**
-50	Viton® polymer blend	N/A	S-1125
-51	Elastomer polymer blend	/164	S-1124
-71	Flexible polyolefin	/42 or /86	S-1017 or S-1048

*For more information, please see the appropriate material page in this section.

**For more information, please see section 5.

Product Dimensions

Part No.	H			J			K Max. b	P ±10% b	JO ±10% b	S ±.03[0.76] b	T ±.03[0.76] b	W Min. b	B Nom. b
	Min. a-50, -51	a-71	Max. b	Min. a-50, -51	a-71	Max. b							
202C611	14.2 [.56]	17.5 [.69]	6.9 [.27]	11.2 [.44]	14.2 [.56]	4.8 [.19]	21.1 [.83]	120.7 [4.75]	17.5 [.69]	1.52 [.06]	1.27 [.05]	0.33 [.013]	62.5 [2.46]
202C621	22.4 [.88]	26.4 [1.04]	11.7 [.46]	17.8 [.70]	26.4 [1.04]	8.1 [.32]	26.7 [1.05]	133.4 [5.25]	19.0 [.78]	1.52 [.06]	1.27 [.05]	0.46 [.018]	67.8 [2.67]
202C632	34.0 [1.34]	38.1 [1.50]	17.5 [.69]	26.9 [1.06]	38.1 [1.50]	12.7 [.50]	32.8 [1.29]	146.1 [5.75]	22.4 [.88]	1.78 [.07]	1.27 [.05]	0.51 [.020]	73.4 [2.89]
202C642	44.2 [1.74]	47.8 [1.88]	22.4 [.88]	36.6 [1.44]	47.8 [1.88]	17.5 [.69]	37.8 [1.49]	158.8 [6.25]	25.4 [1.00]	1.78 [.07]	1.27 [.05]	0.61 [.024]	78.2 [3.08]
202C653	21.2 [53.8]	54.9 [2.16]	27.9 [1.10]	45.7 [1.80]	54.9 [2.16]	22.4 [.88]	42.9 [1.69]	171.5 [6.75]	28.4 [1.12]	1.78 [.07]	2.03 [.08]	0.61 [.024]	82.8 [3.26]
202C663	22.5 [57.2]	77.2 [3.04]	40.6 [1.60]	57.2 [2.25]	54.6 [2.15]	22.9 [.90]	62.2 [2.45]	236.2 [9.30]	35.1 [1.38]	2.03 [.08]	2.03 [.08]	0.66 [.026]	138.4 [5.45]

Note: Coating is optional. As supplied dimensions appearing in table are for uncoated parts. When coating is added, entry diameters will be reduced by 1.5 [.06] max.

VITON is a trademark of Dupont Dow Elastomers LLC.

Available in:	Americas	Europe	Asia Pacific
	■	■	■

Straight, Lipped Boot

As Supplied (a)

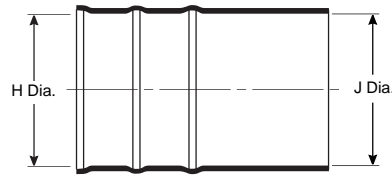

After Unrestricted Recovery (b)

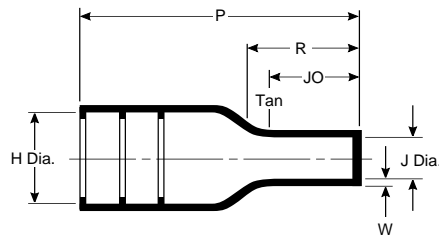

Applications

Use in conjunction with Raychem adapters to provide strain relief for harness systems using circular connectors. Boot is compatible with all Raychem grooved adapters of appropriate shell size.

Materials Available

Material*	Material Description	Precoating No.	Adhesive Part No.**
-3	Semirigid polyolefin	/42 or /86	S-1017 or S-1048
-4	Flexible polyolefin	/42 or /86	S-1017 or S-1048
-12	Viton®	N/A	S-1255-04
-25	Fluid-resistant elastomer	/42 or /86 or /225	S-1017 or S-1048 or S-1125
-100	Polyolefin, Zerohal	/180	S-1030

*For more information, please see the appropriate material page in this section.
 **For more information, please see section 5.

Product Dimensions

Part No.	H		J			P ±10% b	JO ±10% b	W ±20% b	RR ±10% b
	Min. a	Max. b	Min.		Max. b				
			-3, -4, -25 a	-12, -100 a					
202D121	23.3 [.92]	10.5 [.41]	23.3 [.92]	12.4 [.49]	5.6 [.22]	38.1 [1.50]	10.2 [.40]	1.78 [.07]	—
202D132	28.4 [1.12]	14.3 [.56]	28.4 [1.12]	14.7 [.58]	6.6 [.26]	54.9 [2.16]	16.5 [.65]	1.78 [.07]	21.6 [.85]
202D142	31.0 [1.22]	17.8 [.70]	31.0 [1.22]	16.0 [.63]	7.2 [.28]	66.8 [2.63]	17.8 [.70]	2.03 [.08]	24.5 [.96]
202D153	36.0 [1.42]	22.4 [.88]	36.0 [1.42]	18.5 [.73]	8.4 [.33]	80.0 [3.15]	20.8 [.82]	2.03 [.08]	29.7 [1.17]
202D163	42.7 [1.68]	28.2 [1.11]	42.7 [1.68]	22.0 [.87]	9.9 [.39]	103.6 [4.08]	24.6 [.97]	2.29 [.09]	36.7 [1.44]
202D174	51.8 [2.04]	35.1 [1.38]	51.8 [2.04]	35.3 [1.39]	15.8 [.62]	130.3 [5.13]	39.6 [1.56]	3.30 [.13]	53.8 [2.12]
202D185	66.0 [2.60]	44.5 [1.75]	66.0 [2.60]	45.7 [1.80]	20.4 [.80]	165.1 [6.50]	48.3 [1.90]	4.06 [.16]	65.6 [2.59]
202D196	81.7 [3.22]	57.6 [2.27]	81.7 [3.22]	57.1 [2.25]	25.4 [1.00]	177.8 [7.00]	47.8 [1.88]	4.06 [.16]	67.1 [2.64]

Note: Coating is optional. As supplied dimensions appearing in table are for uncoated parts. When coating is added, entry diameters will be reduced by 1.5 [.06] max.

VITON is a trademark of Dupont Dow Elastomers LLC.

Available in:	Americas	Europe	Asia Pacific
	■	■	■

Straight, Lipped Boot

As Supplied (a)



After Unrestricted Recovery (b)

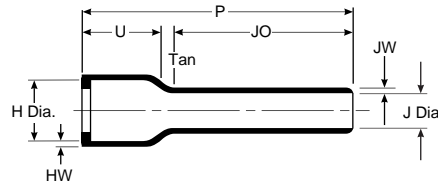

Applications

Use with circular connectors and the appropriate Raychem backshell adapter to provide connector/cable strain relief. Boot is used on

open-wire-bundle airborne harnesses, or applications where the long tail replaces cable jacketing removed during termination.

Materials Available

Material*	Material Description	Precoating No.	Adhesive Part No.**
-3	Semirigid polyolefin	/42 or /86	S-1017 or S-1048
-4	Flexible polyolefin	/42 or /86	S-1017 or S-1048
-12	Viton®	N/A	S-1255-04
-25	Fluid-resistant elastomer	/42 or /86 or /225	S-1017 or S-1048 or S-1125
-100	Polyolefin, Zerohal	/86 or /180	S-1048 or S-1030

*For more information, please see the appropriate material page in this section.

**For more information, please see section 5.

Product Dimensions

Part No.	H		J			P ±10% b	JO ±10% b	U ±10% b	HW ±20% b	JW ±20% b
	Min. a	Max. b	Min.							
			-3, -4, -25 a	-12, -100 a	Max. b					
202D211	22.4 [.88]	11.4 [.45]	22.4 [.88]	14.0 [.55]	6.4 [.25]	105.9 [4.17]	86.4 [3.40]	14.2 [.56]	1.52 [.06]	1.14 [.045]
202D221	25.7 [1.01]	15.0 [.59]	25.7 [1.01]	16.0 [.63]	7.4 [.29]	121.2 [4.77]	98.6 [3.88]	15.0 [.59]	1.52 [.06]	1.14 [.045]
202D232	29.5 [1.16]	18.8 [.74]	29.5 [1.16]	18.3 [.72]	8.4 [.33]	138.7 [5.46]	112.8 [4.44]	15.5 [.61]	1.78 [.07]	1.14 [.045]
202D242	34.0 [1.34]	22.9 [.90]	34.0 [1.34]	21.3 [.84]	9.7 [.38]	159.5 [6.28]	130.8 [5.15]	15.7 [.62]	1.78 [.07]	1.14 [.045]
202D253	37.3 [1.47]	29.5 [1.16]	37.3 [1.47]	23.1 [.91]	10.4 [.41]	177.8 [7.00]	142.2 [5.60]	18.0 [.71]	2.0 [.08]	1.14 [.045]
202D263	43.7 [1.72]	34.0 [1.34]	43.7 [1.72]	27.2 [1.07]	12.2 [.48]	203.2 [8.00]	163.1 [6.42]	19.8 [.78]	2.0 [.08]	1.14 [.045]
202D274	50.0 [1.97]	41.2 [1.62]	50.0 [1.97]	31.5 [1.24]	14.2 [.56]	203.2 [8.00]	157.7 [6.21]	20.8 [.82]	2.3 [.09]	1.40 [.055]
202D285	62.7 [2.47]	47.0 [1.85]	62.7 [2.47]	39.1 [1.54]	17.5 [.69]	203.2 [8.00]	153.2 [6.03]	23.4 [.92]	2.5 [.10]	1.40 [.055]
202D296	69.3 [2.73]	59.7 [2.35]	69.3 [2.73]	43.2 [1.70]	19.6 [.77]	203.2 [8.00]	143.3 [5.64]	23.6 [.93]	2.5 [.10]	1.40 [.055]
202D299	81.8 [3.22]	67.1 [2.64]	81.8 [3.22]	51.1 [2.01]	22.9 [.90]	203.2 [8.00]	138.4 [5.45]	31.2 [1.23]	2.5 [.10]	1.40 [.055]

Note: Coating is optional. As supplied dimensions appearing in table are for uncoated parts. When coating is added, entry diameters will be reduced by 1.5 [.06] max.

VITON is a trademark of Dupont Dow Elastomers LLC.

Available in:	Americas	Europe	Asia Pacific
	■	■	■

Straight, Lipped Boot

As Supplied (a)

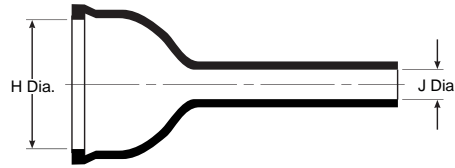

After Unrestricted Recovery (b)

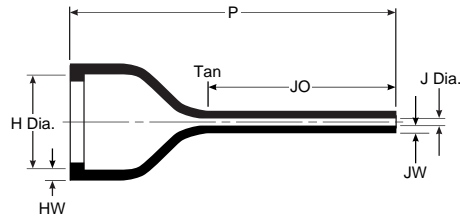

Applications

Use with circular connectors and the appropriate Raychem backshell adapter to provide connector/cable strain relief. Boot is used in applications where only a small number of the available contacts are utilized, thus resulting in a high ratio between the adapter and cable diameters.

Materials Available

Material*	Material Description	Precoating No.	Adhesive Part No.**
-3	Semirigid polyolefin	/42 or /86	S-1017 or S-1048
-4	Flexible polyolefin	/42 or /86	S-1017 or S-1048
-12	Viton®	N/A	S-1255-04
-25	Fluid-resistant elastomer	/42 or /86 or /225	S-1017 or S-1048 or S-1125
-100	Polyolefin, Zerohal	/86 or /180	S-1048 or S-1030

*For more information, please see the appropriate material page in this section.

**For more information, please see section 5.

Product Dimensions

Part No.	H		J			P ±10% b	JO ±10% b	HW ±20% b	JW ±20% b
	Min. a	Max. b	Min.						
			-3, -4, -25 a	-12, -100 a	Max. b				
202D921	19.3 [.76]	13.0 [.51]	6.3 [.25]	4.5 [.18]	2.1 [.08]	60.2 [2.37]	37.6 [1.48]	1.52 [.06]	1.14 [.045]
202D932	26.1 [1.03]	19.1 [.75]	7.6 [.30]	5.5 [.22]	2.6 [.10]	74.2 [2.92]	45.0 [1.77]	1.78 [.07]	1.14 [.045]
202D953	34.2 [1.35]	26.0 [1.02]	9.6 [.38]	6.6 [.26]	3.1 [.12]	84.3 [3.32]	51.1 [2.01]	1.78 [.07]	1.14 [.045]
202D963	43.6 [1.72]	34.1 [1.34]	11.4 [.45]	7.8 [.31]	3.6 [.14]	99.6 [3.92]	57.7 [2.27]	1.78 [.07]	1.14 [.045]

Note: Coating is optional. As supplied dimensions appearing in table are for uncoated parts. When coating is added, entry diameters will be reduced by 1.5 [.06] max.

VITON is a trademark of Dupont Dow Elastomers LLC.

Available in:	Americas	Europe	Asia Pacific
	■	■	■

Straight, Lipped Boot

As Supplied (a)



After Unrestricted Recovery (b)

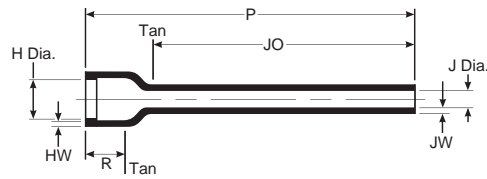

Applications

Use in conjunction with Raychem adapters to provide strain relief for harness systems using circular connectors. Boot is compatible with all Raychem grooved adapters of the appropriate shell size.

Materials Available

Material*	Material Description	Precoating No.	Adhesive Part No.**
-50	Flexible Viton® polymer blend	N/A	S-1125
-51	Flexible elastomer polymer blend	/164	S-1124
-71	Flexible polyolefin	/42 or /86	S-1017 or S-1048

Product Dimensions

Part No.	H		J		P	JO	HW	JW
	Min. a	Max. b	Min. a	Max. b	±10% b	±10% b	±20% b	±20% b
202F211	23.9 [.94]	9.9 [.39]	17.3 [.68]	6.6 [.26]	105.9 [4.17]	86.4 [3.40]	1.5 [.06]	1.5 [.06]
202F221	27.2 [1.07]	13.2 [.52]	20.8 [.82]	7.6 [.30]	121.2 [4.77]	98.6 [3.88]	1.5 [.06]	1.5 [.06]
202F232	31.0 [1.22]	18.5 [.73]	24.4 [.96]	8.9 [.35]	138.7 [5.46]	112.8 [4.44]	1.8 [.07]	1.5 [.06]
202F242	35.6 [1.40]	22.1 [.87]	28.7 [1.13]	10.2 [.40]	159.5 [6.28]	130.8 [5.15]	1.8 [.07]	1.5 [.06]
202F253	38.9 [1.53]	28.2 [1.11]	31.5 [1.24]	10.9 [.43]	177.8 [7.00]	142.2 [5.60]	1.8 [.07]	1.5 [.06]
202F263	45.2 [1.78]	32.3 [1.27]	38.4 [1.51]	12.7 [.50]	203.2 [8.00]	163.1 [6.42]	1.8 [.07]	1.5 [.06]
202F274	51.6 [2.03]	41.1 [1.62]	45.5 [1.79]	15.0 [.59]	203.2 [8.00]	157.7 [6.21]	1.8 [.07]	1.8 [.07]

Note: Coating is optional. As supplied dimensions appearing in table are for uncoated parts. When coating is added, entry diameters will be reduced by 1.5 [.06] max.

VITON is a trademark of Dupont Dow Elastomers LLC.

Available in:	Americas	Europe	Asia Pacific
	■	■	■

Straight, Low Profile Lipped Boot

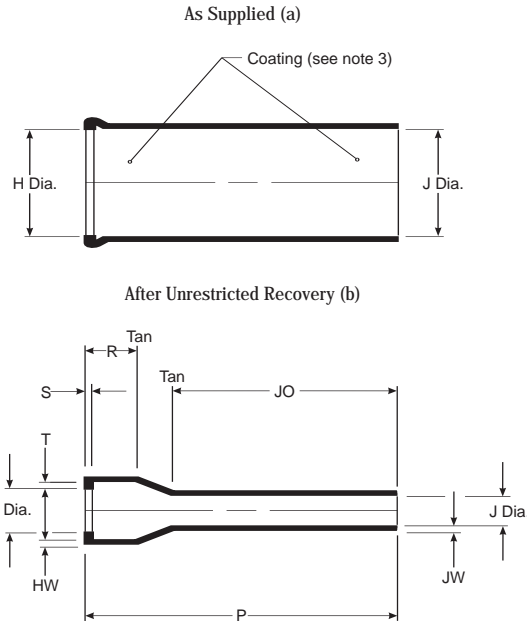

Applications

Use in conjunction with Raychem adapters to provide strain relief for harness systems using circular connectors. This range of parts is compatible with all Raychem grooved adapters of appropriate shell or entry size. When used with adhesive it provides environmental sealing.

Materials Available

Material Dash No.	Material Description	Adhesive
-55	Fluoropolymer	S-1255-04

Product Dimensions

Part No.	H		J		P ±10% b	R ±10% b	S Ref. b	T Ref. b	JO ±10% b	HW Ref. b	JW Ref. b
	Min. a	Max. b	Min. a	Max. b							
202G211	23.9 [.94]	9.9 [.39]	23.9 [.94]	7.4 [.29]	105.9 [4.17]	11.7 [.46]	1.0 [.04]	1.3 [.05]	86.4 [3.40]	1.0 [.04]	0.7 [.03]
202G221	27.2 [1.07]	13.2 [.52]	27.2 [1.07]	8.4 [.33]	121.2 [4.77]	12.2 [.48]	1.0 [.04]	1.3 [.05]	87.4 [3.44]	1.0 [.04]	0.7 [.03]
202G232	31.0 [1.22]	18.5 [.73]	31.0 [1.22]	9.4 [.37]	138.7 [5.46]	12.2 [.48]	1.0 [.04]	1.3 [.05]	104.4 [4.11]	1.0 [.04]	0.7 [.03]
202G242	31.7 [1.25]	22.1 [.87]	31.7 [1.25]	10.7 [.42]	159.5 [6.28]	12.2 [.48]	1.0 [.04]	1.5 [.06]	124.5 [4.90]	1.0 [.04]	0.7 [.03]
202G253	38.9 [1.53]	28.2 [1.11]	38.9 [1.53]	11.9 [.47]	177.8 [7.00]	10.6 [.42]	1.3 [.05]	1.8 [.07]	143.5 [5.65]	1.3 [.05]	1.0 [.04]

Available in:	Americas	Europe	Asia Pacific
	■	■	■

Uniboot

As Supplied (a)



After Unrestricted Recovery (b)

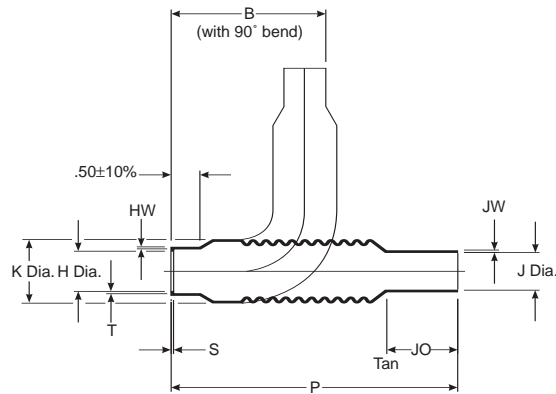

Applications

Use to provide abrasion protection for connectors. The flexibility of design allows a variety of cable outlet angles. When installed on a spin-coupling adapter, cold re-entry to the connector is possible by

unscrewing the adapter and compressing the molded part. When used with adhesive it provides environmental sealing.

Materials Available

Material Dash No.	Material Description	Adhesive
-55	Fluoropolymer	S-1255-04

Product Dimensions

Part No.	H		J		K Max. b	P ±10% b	JO ±10% b	HW Ref. b	JW Ref. b	S Ref. b	T Ref. b	B Nom. b
	Min. a	Max. b	Min. a	Max. b								
202G611	14.2 [1.56]	6.9 [2.7]	11.2 [1.44]	4.8 [1.9]	21.1 [8.3]	120.7 [4.75]	17.5 [6.9]	1.0 [0.4]	0.7 [0.3]	1.0 [0.4]	1.3 [0.5]	62.5 [2.46]
202G621	26.6 [1.05]	11.7 [4.6]	26.6 [1.05]	8.1 [3.2]	26.6 [1.05]	133.8 [5.27]	19.9 [7.8]	1.0 [0.4]	0.7 [0.3]	1.0 [0.4]	1.3 [0.5]	67.8 [2.67]
202G632	33.0 [1.30]	17.5 [6.9]	33.0 [1.30]	12.7 [5.0]	32.7 [1.29]	151.1 [5.95]	22.4 [8.8]	1.0 [0.4]	0.7 [0.3]	1.0 [0.4]	1.3 [0.5]	73.4 [2.89]
202G642	35.5 [1.40]	22.3 [8.8]	35.5 [1.40]	17.5 [6.9]	37.8 [1.49]	157.2 [6.19]	25.4 [1.00]	1.3 [0.5]	1.0 [0.4]	1.3 [0.5]	1.3 [0.5]	78.2 [3.08]
202G653	42.6 [1.68]	27.9 [1.10]	42.6 [1.68]	22.4 [8.8]	42.9 [1.69]	170.2 [6.70]	28.4 [1.12]	1.3 [0.5]	1.0 [0.4]	1.3 [0.5]	1.5 [0.6]	82.8 [3.26]

Available in:	Americas	Europe	Asia Pacific
	■	■	■

Straight, Lipped Boot

As Supplied (a)

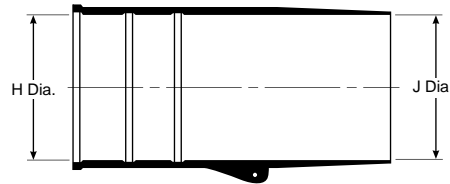

After Unrestricted Recovery (b)

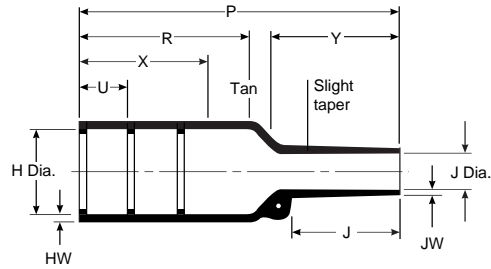

202K121 - 153 = 2 lips
 202K163 - 185 = 3 lips
 Mod 01 = 1 lip removed
 Mod 02 = 2 lips removed
 (only available in sizes 163, 174, 185).
 For eyelet clip, order CS-1858 option.



Applications

Use in conjunction with Raychem adapters to provide strain relief for harness systems using circular connectors.

Boot is compatible with all Raychem grooved adapters of the appropriate shell size.

Materials Available

Material*	Material Description	Precoating No.	Adhesive Part No.**
-3	Semirigid polyolefin	/42 or /86	S-1017 or S-1048
-4	Flexible polyolefin	/42 or /86	S-1017 or S-1048
-12	Viton®	N/A	S-1255-04
-25	Fluid-resistant elastomer	/42 or /86 or /225	S-1017 or S-1048 or S-1125
-100	Polyolefin, Zerohal	/86 or /180	S-1048 or S-1030

*For more information, please see the appropriate material page in this section.

**For more information, please see section 5.

Product Dimensions

Part No.	H		J				P	R	U	JO	HW	JW	X	Y	
	Min.	Max.	Min.	Min.	Max.	Min.									Max.
	-3, -4, -12, -25	b	-3, -4, -25	-12	-100	a	a	b	b	b	b	b	b	b	b
202K121	24.0 [1.95]	10.4 [.41]	24.0 [1.95]	13.0 [.51]	14.0 [.55]	5.6 [.22]	38.0 [1.50]	21.0 [.83]	12.0 [.47]	8.5 [.33]	1.6 [.06]	.41 [.016]	24.0 [.94]	13.0 [.51]	
202K132	30.0 [1.18]	14.2 [.56]	30.0 [1.18]	14.0 [.55]	15.0 [.59]	5.9 [.23]	55.0 [2.17]	32.0 [1.26]	12.0 [.47]	11.5 [.45]	1.8 [.07]	.81 [.032]	24.0 [.94]	18.0 [.71]	
202K142	31.0 [1.22]	18.0 [.71]	31.0 [1.22]	16.0 [.63]	18.0 [.71]	7.1 [.28]	67.0 [2.64]	35.0 [1.38]	20.0 [.79]	17.0 [.67]	1.8 [.07]	.81 [.032]	32.0 [1.26]	25.0 [.98]	
202K153	36.0 [1.42]	22.4 [.88]	36.0 [1.42]	19.0 [.75]	21.0 [.83]	8.4 [.33]	80.0 [3.15]	42.0 [1.65]	20.0 [.79]	19.5 [.76]	2.0 [.08]	.81 [.032]	32.0 [1.26]	30.0 [1.18]	
202K163	43.0 [1.69]	28.2 [1.11]	43.0 [1.69]	22.0 [.87]	25.0 [.98]	9.9 [.39]	99.0 [3.90]	61.0 [2.40]	20.0 [.79]	21.0 [.82]	2.2 [.08]	.81 [.032]	52.0 [2.05]	30.0 [1.18]	
202K174	60.0 [2.36]	35.1 [1.38]	60.0 [2.36]	35.0 [1.38]	39.0 [1.54]	15.7 [.62]	130.0 [5.12]	72.0 [2.83]	20.0 [.79]	39.0 [1.53]	3.3 [.13]	1.02 [.040]	52.0 [2.05]	50.0 [1.97]	
202K185	66.0 [2.60]	44.5 [1.75]	66.0 [2.60]	38.0 [1.50]	42.0 [1.65]	16.8 [.66]	170.0 [6.69]	90.0 [3.54]	20.0 [.79]	51.5 [2.02]	3.8 [.15]	1.63 [.064]	52.0 [2.05]	70.0 [2.76]	

Note: Coating is optional. As supplied dimensions appearing in table are for uncoated parts. When coating is added, entry diameters will be reduced by 1.5 [.06] max.

VITON is a trademark of Dupont Dow Elastomers LLC.

Available in:	Americas	Europe	Asia Pacific
	■	■	■

Catalog 1654025
 Revised 12-04

www.tycoelectronics.com

Dimensions are in millimeters and inches unless otherwise specified. Values in brackets are U.S. equivalents.

Dimensions are shown for reference purposes only. Specifications subject to change.

USA: 1-800-522-6752
 Canada: 1-905-470-4425
 Mexico: 01-800-733-8926
 C. America: 52-55-5-729-0425

South America: 55-11-3611-1514
 Japan: 81-44-900-5102
 Singapore: 65-4866-151
 UK: 44-1793-528171

D-Subminiature, Straight Boot

As Supplied (a)

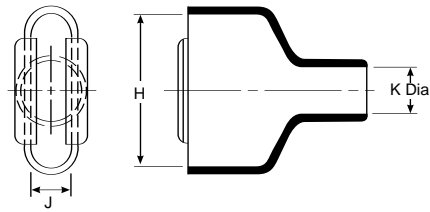

After Unrestricted Recovery (b)

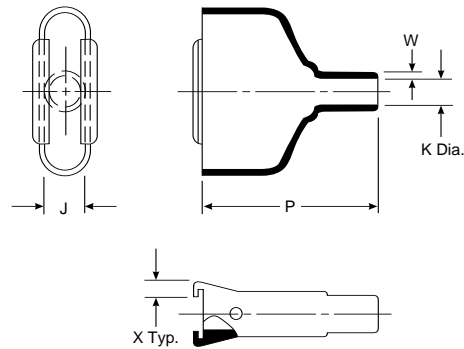

Applications

Provides strain relief and mechanical protection on D-subminiature connector terminations.

Materials Available

Material*	Material Description	Precoating No.	Adhesive Part No.**
-3	Semirigid polyolefin	/42 or /86	S-1017 or S-1048
-4	Flexible polyolefin	/42 or /86	S-1017 or S-1048
-12	Viton®	N/A	S-1255-04
-25	Fluid-resistant elastomer	/42 or /86 or /225	S-1017 or S-1048 or S-1125
-100	Polyolefin, Zerohal	/86 or /180	S-1048 or S-1030

*For more information, please see the appropriate material page in this section.
 **For more information, please see section 5.

Product Dimensions

Part No.	H		J		K		P	W	X	This Boot Fits	
	±5% a	±5% b	±5% a	±5% b	Min. a	Max. b				±10% b	±20% b
214A011	20.3 [.80]	20.3 [.80]	10.7 [.42]	10.7 [.42]	7.9 [.31]	4.1 [.16]	33.3 [1.31]	1.0 [.04]	3.0 [.12]	DE-9	XX09X
214A021	28.2 [1.11]	28.2 [1.11]	10.7 [.42]	10.7 [.42]	10.2 [.40]	5.3 [.21]	38.9 [1.53]	1.0 [.04]	3.0 [.12]	DA-15	XX15X
214A032	42.2 [1.66]	42.2 [1.66]	10.7 [.42]	10.7 [.42]	14.0 [.55]	8.1 [.32]	45.0 [1.77]	1.0 [.04]	3.0 [.12]	DB-25	XX25X
214A042	58.7 [2.31]	58.7 [2.31]	10.7 [.42]	10.7 [.42]	17.3 [.68]	8.6 [.34]	53.3 [2.10]	1.0 [.04]	3.0 [.12]	DC-37	XX37X
214A052	57.9 [2.28]	57.9 [2.28]	13.7 [.54]	13.7 [.54]	19.1 [.75]	10.7 [.42]	61.0 [2.40]	1.0 [.04]	3.0 [.12]	DD-50	XX50X

Note: Coating is optional. As supplied dimensions appearing in table are for uncoated parts. When coating is added, entry diameters will be reduced by 1.5 [.06] max.

VITON is a trademark of Dupont Dow Elastomers LLC.

Available in:	Americas	Europe	Asia Pacific
	■	■	■

D-Subminiature, Straight Boot

As Supplied (a)

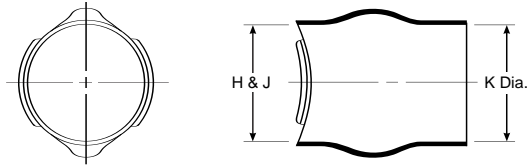

After Unrestricted Recovery (b)

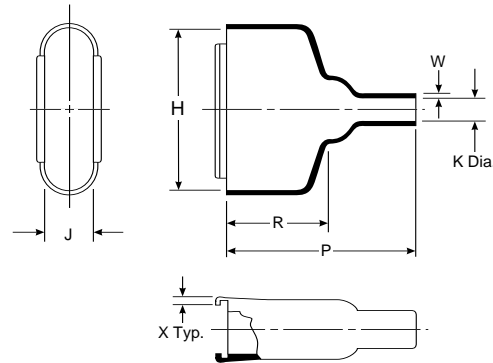

Applications

Provides strain relief and mechanical protection on D-subminiature connector terminations.

Materials Available

Material*	Material Description	Precoating No.	Adhesive Part No.**
-3	Semirigid polyolefin	/42 or /86	S-1017 or S-1048
-4	Flexible polyolefin	/42 or /86	S-1017 or S-1048
-25	Fluid-resistant elastomer	/42 or /86	S-1017 or S-1048 or S-1125

*For more information, please see the appropriate material page in this section.

**For more information, please see section 5.

Product Dimensions

Part No.	H		J		K		P ±10% b	R ±10% b	W ±20% b	X ±20% b	This Boot Fits	
	±5% a	±5% b	±5% a	±5% b	Min. a	Max. b					Cannon/ Cinch	Amphenol Series 17
214A311	16.0 [.63]	20.3 [.80]	16.0 [.63]	10.7 [.42]	16.0 [.63]	4.1 [.16]	33.3 [1.31]	19.1 [.75]	1.02 [.04]	3.05 [.12]	DE-9	XX09X
214A321	19.1 [.75]	28.2 [1.11]	19.1 [.75]	10.7 [.42]	19.1 [.75]	5.3 [.21]	38.9 [1.53]	22.1 [.87]	1.02 [.04]	3.05 [.12]	DA-15	XX15X
214A332	29.2 [1.15]	42.2 [1.66]	29.2 [1.15]	10.7 [.42]	29.2 [1.15]	8.1 [.32]	45.0 [1.77]	25.4 [1.00]	1.02 [.04]	3.05 [.12]	DB-25	XX25X
214A342	34.3 [1.35]	58.7 [2.31]	34.3 [1.35]	10.7 [.42]	34.3 [1.35]	8.6 [.34]	53.3 [2.10]	28.4 [1.12]	1.02 [.04]	3.05 [.12]	DC-37	XX37X
214A352	37.6 [1.48]	57.9 [2.28]	37.6 [1.48]	13.7 [.54]	37.6 [1.48]	10.7 [.42]	61.0 [2.40]	31.8 [1.25]	1.02 [.04]	3.05 [.12]	DD-50	XX50X

Note: Coating is optional. As supplied dimensions appearing in table are for uncoated parts. When coating is added, entry diameters will be reduced by 1.5 [.06] max.

Available in:	Americas	Europe	Asia Pacific
	■	■	■

D-Subminiature, Straight Boot with Jack Screws

As Supplied (a)

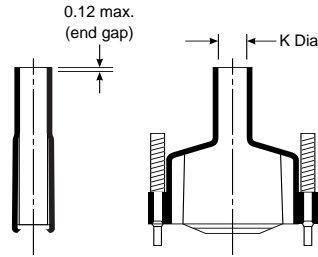

After Unrestricted Recovery (b)

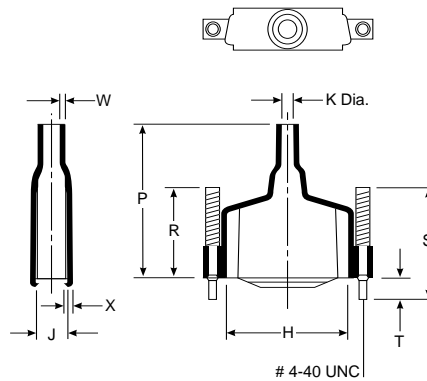

Applications

Provides strain relief and mechanical protection on D-subminiature connector terminations.

Materials Available

Material*	Material Description
-111-0	Semirigid polyolefin (black)
-111-8	Semirigid polyolefin (gray)

*Contact Tyco Electronics for information on material properties.

Product Dimensions

Part No.	H ±5% b	J ±10% b	K		P ±10% b	R Ref. b	S Nom. b	T Nom. b	X ±20% b	W ±20% b	Fits Connector Size
			Min. a	Max. b							
214P009-XXX	17.3 [.68]	12.0 [.47]	9.0 [.35]	3.8 [.15]	43.0 [1.69]	22.0 [.87]	29.0 [1.14]	6.4 [.25]	1.80 [.07]	1.5 [.06]	9 pin
214P015-XXX	25.2 [.99]	12.0 [.47]	10.5 [.41]	3.8 [.15]	44.0 [1.73]	23.0 [.90]	29.0 [1.14]	6.4 [.25]	2.03 [.08]	1.5 [.06]	15 pin
214P025-XXX	38.4 [1.51]	12.0 [.47]	12.0 [.47]	5.1 [.20]	49.0 [1.87]	25.0 [.98]	29.0 [1.14]	6.4 [.25]	2.16 [.085]	1.5 [.06]	25 pin
214P037-XXX	54.2 [2.13]	12.0 [.47]	12.0 [.47]	5.8 [.22]	55.0 [2.16]	25.0 [.98]	29.0 [1.14]	6.4 [.25]	2.26 [.089]	1.5 [.06]	37 pin

Note: Coating is optional. As supplied dimensions appearing in table are for uncoated parts. When coating is added, entry diameters will be reduced by 1.5 [.06] max.

Available in:	Americas	Europe	Asia Pacific
	■	■	■

Right-Angled Boot

As Supplied (a)

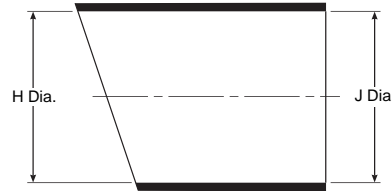

After Unrestricted Recovery (b)

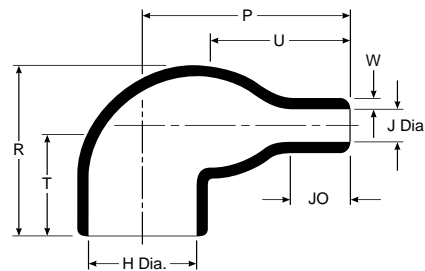

Applications

Use for mechanical protection and connector-cable strain relief. This family of boots has no lip, so a boot can be installed directly onto the connector accessory thread.

Materials Available

Material*	Material Description	Precoating No.	Adhesive Part No.**
-3	Semirigid polyolefin	/42 or /86	S-1017 or S-1048
-4	Flexible polyolefin	/42 or /86	S-1017 or S-1048
-12	Viton®	N/A	S-1255-04
-25	Fluid-resistant elastomer	/42 or /86 or /225	S-1017 or S-1048 or S-1125
-100	Polyolefin, Zerohal	/86 or/180	S-1048 or S-1030

*For more information, please see the appropriate material page in this section.

**For more information, please see section 5.

Product Dimensions

Part No.	H		J				P ±10% b	R ±10% b	T ±10% b	U ±10% b	JO ±10% b	W ±20% b
	Min. a	Max. b	Min. -3, -4, -25 a	Min. -100 a	Min. -12 a	Max. b						
222A111	17.8 [.70]	7.9 [.31]	17.8 [.70]	10.9 [.43]	9.9 [.39]	3.8 [.15]	17.3 [.68]	20.1 [.79]	—	11.4 [.45]	4.3 [.17]	1.02 [.04]
222A121	24.9 [.98]	10.2 [.40]	24.9 [.98]	16.0 [.63]	18.0 [.71]	5.3 [.21]	21.3 [.84]	22.6 [.89]	—	14.7 [.58]	5.8 [.23]	1.27 [.05]
222A132	30.0 [1.18]	14.2 [.56]	30.0 [1.18]	21.1 [.83]	20.6 [.81]	6.4 [.25]	26.9 [1.06]	26.7 [1.05]	19.1 [.75]	17.8 [.70]	7.1 [.28]	1.52 [.06]
222A142	32.5 [1.28]	17.3 [.68]	32.5 [1.28]	22.9 [.90]	22.9 [.90]	6.9 [.27]	36.6 [1.44]	30.5 [1.20]	19.1 [.75]	24.9 [.98]	10.2 [.40]	1.78 [.07]
222A152	36.1 [1.42]	21.8 [.86]	36.1 [1.42]	27.4 [1.08]	26.4 [1.04]	8.4 [.33]	43.7 [1.72]	35.1 [1.38]	19.1 [.75]	30.0 [1.18]	12.7 [.50]	1.78 [.07]
222A163	43.9 [1.73]	27.4 [1.08]	43.9 [1.73]	28.4 [1.12]	27.4 [1.08]	9.4 [.37]	53.6 [2.11]	43.9 [1.73]	19.1 [.75]	34.0 [1.34]	17.3 [.68]	2.03 [.08]
222A174	53.1 [2.09]	33.8 [1.33]	53.1 [2.09]	48.3 [1.90]	46.7 [1.84]	15.0 [.59]	75.7 [2.98]	52.8 [2.08]	25.4 [1.00]	53.3 [2.10]	32.0 [1.26]	3.30 [.13]
222A185	67.6 [2.66]	44.2 [1.74]	67.6 [2.66]	58.4 [2.30]	54.4 [2.14]	20.3 [.80]	97.5 [3.84]	66.0 [2.60]	25.4 [1.00]	71.1 [2.80]	40.6 [1.60]	3.81 [.15]
222A196	87.6 [3.45]	55.4 [2.18]	87.6 [3.45]	68.8 [2.71]	63.0 [2.48]	23.4 [.92]	128.0 [5.04]	79.2 [3.12]	25.4 [1.00]	87.6 [3.45]	56.4 [2.22]	4.57 [.18]

Note: Coating is optional. As supplied dimensions appearing in table are for uncoated parts. When coating is added, entry diameters will be reduced by 1.5 [.06] max.

VITON is a trademark of Dupont Dow Elastomers LLC.

Available in:	Americas	Europe	Asia Pacific
	■	■	■

Catalog 1654025
Revised 12-04

www.tycoelectronics.com

Dimensions are in millimeters and inches unless otherwise specified. Values in brackets are U.S. equivalents.

Dimensions are shown for reference purposes only. Specifications subject to change.

USA: 1-800-522-6752
Canada: 1-905-470-4425
Mexico: 01-800-733-8926
C. America: 52-55-5-729-0425

South America: 55-11-3611-1514
Japan: 81-44-900-5102
Singapore: 65-4866-151
UK: 44-1793-528171

Right-Angled, Lipped Boot

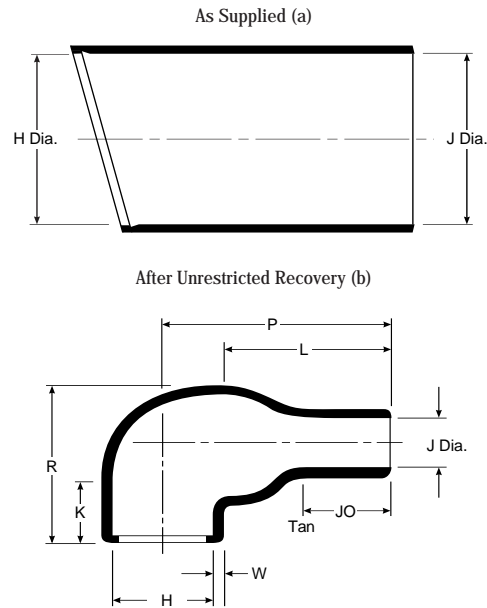

Applications

Use in conjunction with Raychem adapters to provide strain relief for harness systems using circular connectors. Boot is compatible with all Raychem grooved adapters of the appropriate shell size.

Materials Available

Material*	Material Description	Precoating No.	Adhesive Part No.**
-3	Semirigid polyolefin	/42 or /86	S-1017 or S-1048
-4	Flexible polyolefin	/42 or /86	S-1017 or S-1048
-12	Viton®	N/A	S-1255-04
-25	Fluid-resistant elastomer	/42 or /86 or /225	S-1017 or S-1048 or S-1125
-100	Polyolefin, Zerohal	/86 or /180	S-1048 or S-1030

*For more information, please see the appropriate material page in this section.
 **For more information, please see section 5.

Product Dimensions

Part No.	H		J				P ±10% b	R Ref. b	JO ±10%	W ±20%	K ±10% b	L ±10% b
	Min. a	Max. a	-3, -4, -25 b	Min. -100 b	-12 b	Max. b						
222D121	23.4 [.92]	10.4 [.41]	23.4 [.92]	14.0 [.55]	12.4 [.49]	5.6 [.22]	21.3 [.84]	22.6 [.89]	5.8 [.23]	1.27 [.05]	15.2 [.60]	14.7 [.58]
222D132	28.4 [1.12]	14.2 [.56]	28.4 [1.12]	15.0 [.59]	14.7 [.58]	6.6 [.26]	33.8 [1.33]	27.2 [1.07]	15.5 [.65]	1.52 [.06]	19.1 [.75]	24.9 [.98]
222D142	31.0 [1.22]	17.8 [.70]	31.0 [1.22]	18.0 [.71]	16.0 [.63]	7.1 [.28]	36.6 [1.44]	31.0 [1.22]	12.7 [.50]	1.78 [.07]	19.1 [.75]	24.9 [.98]
222D152	36.0 [1.42]	22.4 [.88]	36.0 [1.42]	21.0 [.83]	18.5 [.73]	8.4 [.33]	43.7 [1.72]	35.1 [1.38]	14.5 [.57]	1.78 [.07]	19.1 [.75]	30.0 [1.18]
222D163	42.7 [1.68]	28.2 [1.11]	42.7 [1.68]	25.0 [.98]	22.1 [.87]	9.9 [.39]	53.6 [2.11]	43.9 [1.73]	17.5 [.69]	2.03 [.08]	19.3 [.76]	33.0 [1.30]
222D174	51.8 [2.04]	35.1 [1.38]	51.8 [2.04]	39.0 [1.54]	35.3 [1.39]	15.7 [.62]	78.0 [3.07]	52.8 [2.08]	33.5 [1.32]	3.30 [.13]	25.4 [1.00]	53.8 [2.12]
222D185	66.0 [2.60]	44.5 [1.75]	66.0 [2.60]	42.0 [1.65]	45.7 [1.80]	20.3 [.80]	97.5 [3.84]	66.0 [2.60]	40.1 [1.58]	3.81 [.15]	25.4 [1.00]	71.1 [2.80]
222D196	81.8 [3.22]	60.5 [2.38]	81.8 [3.22]	57.2 [2.25]	57.2 [2.25]	25.4 [1.00]	117.9 [4.64]	83.8 [3.30]	38.1 [1.50]	4.06 [.16]	25.4 [1.00]	80.0 [3.15]

Note: Coating is optional. As supplied dimensions appearing in table are for uncoated parts. When coating is added, entry diameters will be reduced by 1.5 (.06) max.

VITON is a trademark of Dupont Dow Elastomers LLC.

Available in:	Americas	Europe	Asia Pacific
	■	■	■

Right-Angled, Lipped Boot

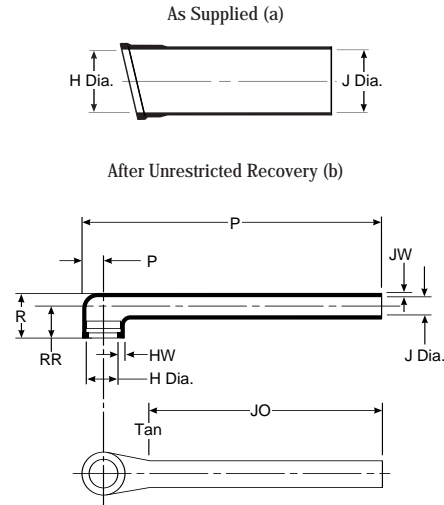

Applications

Provides strain relief and mechanical protection between cable and connector. Boot is usually used on open-wire-bundle airborne harnesses, or applications where the long tail replaces cable jacketing removed during termination.

Materials Available

Material*	Material Description	Precoating No.	Adhesive Part No.**
-3	Semirigid polyolefin	/42 or /86	S-1017 or S-1048
-4	Flexible polyolefin	/42 or /86	S-1017 or S-1048
-12	Viton®	N/A	S-1255-04
-25	Fluid-resistant elastomer	/42 or /86 or /225	S-1017 or S-1048 or S-1125
-100	Polyolefin, Zerohal	/86 or /180	S-1048 or S-1030

*For more information, please see the appropriate material page in this section.

**For more information, please see section 5.

Product Dimensions

Part No.	H		J			P ±10% b	R Ref b	JO ±10% b	PP ±10% b	RR 10% b	HW ±20%	JW ±20%
	Min. a	Max. b	Min. -3, -4, -25 a -12, -100 b		Max. b							
222D211	22.4 [.88]	11.4 [.45]	22.4 [.88]	14.0 [.55]	6.4 [.25]	105.2 [4.14]	18.5 [.73]	87.6 [3.45]	6.9 [.27]	12.4 [.49]	1.52 [.06]	1.14 [.045]
222D221	25.7 [1.01]	15.0 [.59]	25.7 [1.01]	16.0 [.63]	7.4 [.29]	124.0 [4.88]	19.8 [.78]	99.1 [3.90]	8.4 [.33]	15.0 [.59]	1.52 [.06]	1.14 [.045]
222D232	29.5 [1.16]	18.8 [.74]	29.5 [1.16]	18.3 [.72]	8.4 [.33]	146.3 [5.76]	20.8 [.82]	114.3 [4.50]	10.4 [.41]	15.5 [.61]	1.78 [.07]	1.14 [.045]
222D242	34.0 [1.34]	22.9 [.90]	34.0 [1.34]	21.3 [.84]	9.7 [.38]	172.2 [6.78]	21.8 [.86]	132.6 [5.22]	12.2 [.48]	15.7 [.62]	1.78 [.07]	1.14 [.045]
222D253	37.3 [1.47]	29.5 [1.16]	37.3 [1.47]	23.1 [.91]	10.4 [.41]	185.2 [7.29]	24.4 [.96]	143.8 [5.66]	15.5 [.61]	17.8 [.70]	2.03 [.08]	1.14 [.045]
222D263	43.7 [1.72]	34.0 [1.34]	43.7 [1.72]	27.2 [1.07]	12.2 [.48]	231.6 [8.41]	27.4 [1.08]	169.2 [6.66]	18.3 [.72]	19.8 [.78]	2.03 [.08]	1.14 [.045]
222D274	50.0 [1.97]	41.1 [1.62]	50.0 [1.97]	31.5 [1.24]	14.2 [.56]	224.5 [8.84]	29.5 [1.16]	173.2 [6.82]	21.1 [.83]	20.8 [.82]	2.29 [.09]	1.40 [.055]
222D285	62.7 [2.47]	47.0 [1.85]	62.7 [2.47]	39.1 [1.54]	17.5 [.69]	227.3 [8.95]	33.3 [1.31]	168.1 [6.62]	24.1 [.95]	23.4 [.92]	2.54 [.10]	1.40 [.055]
222D296	69.3 [2.73]	59.7 [2.35]	69.3 [2.73]	43.2 [1.70]	19.6 [.77]	233.4 [9.19]	35.1 [1.38]	157.2 [6.19]	30.0 [1.18]	23.6 [.93]	2.54 [.10]	1.40 [.055]
222D299	81.8 [3.22]	67.1 [2.64]	81.8 [3.22]	51.1 [2.01]	22.9 [.90]	237.0 [9.33]	44.5 [1.75]	151.1 [5.95]	33.3 [1.31]	31.2 [1.23]	2.54 [.10]	1.40 [.055]

Note: Coating is optional. As supplied dimensions appearing in table are for uncoated parts. When coating is added, entry diameters will be reduced by 1.5 [.06] max.

VITON is a trademark of Dupont Dow Elastomers LLC.

Available in:	Americas	Europe	Asia Pacific
	■	■	■

Catalog 1654025
Revised 12-04
www.tycoelectronics.com

Dimensions are in millimeters and inches unless otherwise specified. Values in brackets are U.S. equivalents.

Dimensions are shown for reference purposes only. Specifications subject to change.

USA: 1-800-522-6752
Canada: 1-905-470-4425
Mexico: 01-800-733-8926
C. America: 52-55-5-729-0425

South America: 55-11-3611-1514
Japan: 81-44-900-5102
Singapore: 65-4866-151
UK: 44-1793-528171

Right-Angled, Lipped Boot

As Supplied (a)

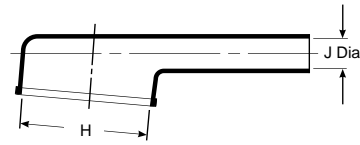

After Unrestricted Recovery (b)

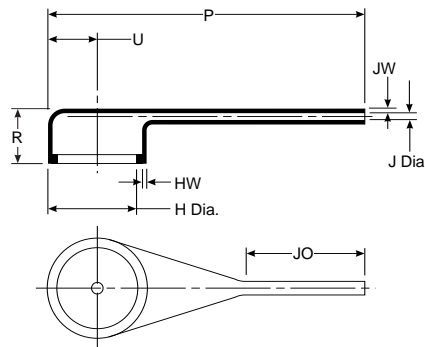

Applications

Provides strain relief and mechanical protection between cable and connector. It is used in applications where only a small number of the available contacts are utilized, resulting in a high ratio between the adapter and cable diameters.

Materials Available

Material*	Material Description	Precoating No.	Adhesive Part No.**
-3	Semirigid polyolefin	/42 or /86	S-1017 or S-1048
-4	Flexible polyolefin	/42 or /86	S-1017 or S-1048
-12	Viton®	N/A	S-1255-04
-25	Fluid-resistant elastomer	/42 or /86 or /225	S-1017 or S-1048 or S-1125
-100	Polyolefin, Zerohal	/86 or /180	S-1048 or S-1030

Product Dimensions

Part No.	H		J			P ±10% b	R Ref. b	U ±10% b	JO ±10% b	HW ±20% b	JW ±20% b
	Min. a	Max. b	Min. -3, -4, -25 a		Max. b						
222D921	19.3 [.76]	13.0 [.51]	6.3 [.25]	4.5 [.18]	2.1 [.08]	44.5 [1.75]	16.3 [.64]	5.6 [.22]	21.8 [.86]	1.52 [.06]	1.14 [.045]
222D932	26.1 [1.03]	19.1 [.75]	7.6 [.30]	5.6 [.22]	2.6 [.10]	67.3 [2.65]	18.0 [.71]	8.4 [.33]	29.2 [1.15]	1.78 [.07]	1.14 [.045]
222D953	34.2 [1.35]	26.0 [1.02]	9.6 [.38]	6.6 [.26]	3.0 [.12]	81.3 [3.20]	18.8 [.74]	11.4 [.45]	36.3 [1.39]	1.78 [.07]	1.14 [.045]
222D963	43.6 [1.72]	34.1 [1.34]	11.4 [.45]	7.8 [.31]	3.6 [.14]	115.6 [4.55]	21.3 [.84]	15.5 [.61]	47.0 [1.85]	1.78 [.07]	1.14 [.045]

Note: Coating is optional. As supplied dimensions appearing in table are for uncoated parts. When coating is added, entry diameters will be reduced by 1.5 mm [.06"] max.

VITON is a trademark of Dupont Dow Elastomers LLC.

Available in:	Americas	Europe	Asia Pacific
	■	■	■

Right-Angled, Lipped Boot

As Supplied (a)



After Unrestricted Recovery (b)

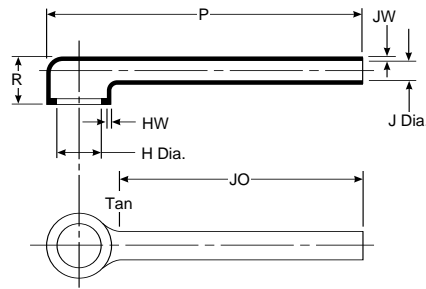

Applications

Use in conjunction with Raychem adapters to provide strain relief for harness systems using circular connectors. Boot is compatible with all Raychem grooved adapters of the appropriate shell size.

Materials Available

Material*	Material Description	Precoating No.	Adhesive Part No.**
-50	Viton® polymer blend	N/A	S-1125
-51	Elastomer polymer blend	/164	S-1124
-71	Flexible polyolefin	/42 or /86	S-1017 or S-1048

*For more information, please see the appropriate material page in this section.

**For more information, please see section 5.

Product Dimensions

Part No.	H		J		P ±10% b	R ±10% b	JO ±10% b	HW +.06 to -.03 b	JW ±.03 b
	Min. a	Max. b	Min. a	Max. b					
222F211	23.9 [.94]	9.9 [.39]	17.3 [.68]	6.6 [.26]	105.2 [4.14]	18.5 [.73]	87.6 [3.45]	1.52 [.06]	1.52 [.06]
222F221	27.2 [1.07]	13.2 [.52]	20.8 [.82]	7.6 [.30]	124.0 [4.88]	19.8 [.78]	99.1 [3.90]	1.52 [.06]	1.52 [.06]
222F232	31.0 [1.22]	18.5 [.73]	24.4 [.96]	8.9 [.35]	146.3 [5.76]	20.8 [.82]	114.3 [4.50]	1.78 [.07]	1.52 [.06]
222F242	35.6 [1.40]	22.1 [.87]	28.7 [1.13]	10.2 [.40]	172.2 [6.78]	21.8 [.86]	132.6 [5.22]	1.78 [.07]	1.52 [.06]
222F253	38.9 [1.53]	28.2 [1.11]	31.5 [1.24]	10.9 [.43]	185.2 [7.29]	24.4 [.96]	143.8 [5.66]	1.78 [.07]	1.52 [.06]
222F263	45.2 [1.78]	32.3 [1.27]	38.4 [1.51]	12.7 [.50]	213.6 [8.41]	27.4 [1.08]	169.2 [6.66]	1.78 [.07]	1.52 [.06]
222F274	51.6 [2.03]	41.1 [1.62]	44.5 [1.75]	15.0 [.59]	224.5 [8.84]	29.5 [1.16]	173.2 [6.82]	1.78 [.07]	1.78 [.07]
222F285	62.7 [2.47]	42.9 [1.69]	47.2 [1.86]	17.5 [.69]	227.3 [8.95]	33.3 [1.31]	168.1 [6.62]	2.03 [.08]	1.78 [.07]

Note: Coating is optional. As supplied dimensions appearing in table are for uncoated parts. When coating is added, entry diameters will be reduced by 1.5 [.06] max.

VITON is a trademark of Dupont Dow Elastomers LLC.

Available in:	Americas	Europe	Asia Pacific
	■	■	■

Catalog 1654025
Revised 12-04

www.tycoelectronics.com

Dimensions are in millimeters and inches unless otherwise specified. Values in brackets are U.S. equivalents.

Dimensions are shown for reference purposes only. Specifications subject to change.

USA: 1-800-522-6752
Canada: 1-905-470-4425
Mexico: 01-800-733-8926
C. America: 52-55-5-729-0425

South America: 55-11-3611-1514
Japan: 81-44-900-5102
Singapore: 65-4866-151
UK: 44-1793-528171

Right-Angled, Lipped Boot

As Supplied (a)

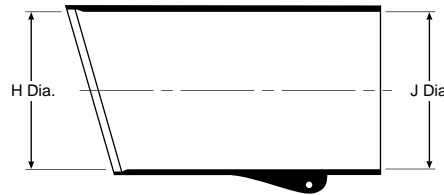

After Unrestricted Recovery (b)

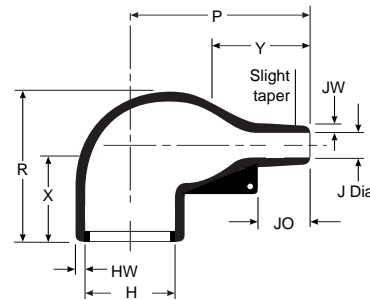

For eyelet clip, order CS-1858 option.



Applications

Use in conjunction with Raychem adapters to provide strain relief for harness systems using circular connectors. Boot is compatible with all Raychem grooved adapters of the appropriate shell size.

Materials Available

Material*	Material Description	Precoating No.	Adhesive Part No.**
-3	Semirigid polyolefin	/42 or /86	S-1017 or S-1048
-4	Flexible polyolefin	/42 or /86	S-1017 or S-1048
-12	Viton®	N/A	S-1255-04
-25	Fluid-resistant elastomer	/42 or /86 or /225	S-1017 or S-1048 or S-1125
-100	Polyolefin, Zerohal	/86 or /180	S-1048 or S-1030

*For more information, please see the appropriate material page in this section.

**For more information, please see section 5.

Product Dimensions

Part No.	H			J				P	R	JO	HW	JW	X	Y
	Min.		Max.	Min.		Max.								
	-3, -4, -25	-100		-3, -4, -25	-100									
	a	a	b	a	a	b	b	b	b	b	b	b	b	b
222K121	24.0 [.95]	24.0 [.95]	10.4 [.41]	24.0 [.95]	14.0 [.55]	5.6 [.22]	25.0 [.98]	25.0 [.98]	8.5 [.33]	1.3 [.05]	.41 [.016]	18.0 [.71]	16.0 [.63]	
222K132	30.0 [1.18]	30.0 [1.18]	14.2 [.56]	30.0 [1.18]	15.0 [.59]	5.9 [.23]	32.0 [1.26]	27.0 [1.06]	8.5 [.33]	1.5 [.06]	.61 [.024]	18.0 [.71]	20.0 [.79]	
222K142	31.0 [1.22]	31.0 [1.22]	18.0 [.71]	31.0 [1.22]	18.0 [.71]	7.1 [.28]	39.0 [1.54]	31.0 [1.22]	15.0 [.59]	1.8 [.07]	.81 [.032]	18.0 [.71]	20.0 [.79]	
222K152	36.0 [1.42]	36.0 [1.42]	22.4 [.88]	36.0 [1.42]	21.0 [.83]	8.4 [.33]	46.0 [1.81]	38.0 [1.50]	18.0 [.63]	1.8 [.07]	.81 [.032]	25.0 [.98]	25.0 [.98]	
222K163	43.0 [1.69]	43.0 [1.69]	28.2 [1.11]	43.0 [1.69]	25.0 [.98]	9.9 [.39]	55.0 [2.17]	45.0 [1.77]	17.5 [.69]	2.0 [.08]	.81 [.032]	25.0 [.98]	30.0 [1.18]	
222K174	60.0 [2.36]	60.0 [2.36]	35.1 [1.38]	60.0 [2.36]	39.0 [1.54]	15.7 [.62]	80.0 [3.15]	54.0 [2.13]	32.0 [1.26]	3.3 [.13]	1.02 [.040]	25.0 [.98]	45.0 [1.77]	
222K185	66.0 [2.60]	66.0 [2.60]	44.5 [1.75]	66.0 [2.60]	42.0 [1.65]	16.8 [.66]	108.0 [4.25]	68.0 [2.68]	48.0 [1.89]	3.8 [.15]	1.63 [.064]	35.0 [1.38]	70.0 [2.76]	

Note: Coating is optional. As supplied dimensions appearing in table are for uncoated parts. When coating is added, entry diameters will be reduced by 1.5 [.06] max.

VITON is a trademark of Dupont Dow Elastomers LLC.

Available in:	Americas	Europe	Asia Pacific
	■	■	■

D-Subminiature,
Right-Angled Boot

As Supplied (a)

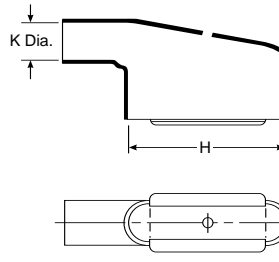

After Unrestricted Recovery (b)

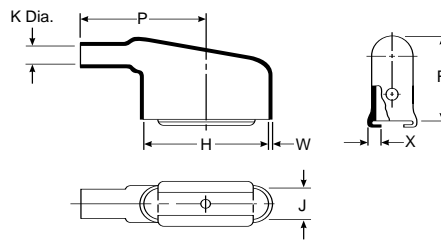

Applications

Provides strain relief and mechanical protection on D-subminiature connector terminations.

Materials Available

Material*	Material Description	Precoating No.	Adhesive Part No.**
-3	Semirigid polyolefin	/42 or /86	S-1017 or S-1048
-4	Flexible polyolefin	/42 or /86	S-1017 or S-1048
-12	Viton®	N/A	S-1255-04
-25	Fluid-resistant elastomer	/42 or /86 or /225	S-1017 or S-1048 or S-1125
-100	Polyolefin, Zerohal	/86 or /180	S-1048 or S-1030

*For more information, please see the appropriate material page in this section.
**For more information, please see section 5.

Product Dimensions

Part No.	H		J		K		P ±10% b	R ±10% b	W ±20% b	X ±20% b	This Boot Fits Cannon/Cinch
	±5% a	±5% b	±5% a	±5% b	Min. a	Max. b					
234A011	20.3 [.80]	20.3 [.80]	10.7 [.42]	10.7 [.42]	7.9 [.31]	4.1 [.16]	25.9 [1.02]	21.6 [.85]	1.02 [.04]	3.05 [.12]	DE-9
234A021	28.2 [1.11]	28.2 [1.11]	10.7 [.42]	10.7 [.42]	10.2 [.40]	5.3 [.21]	30.7 [1.21]	24.6 [.97]	1.02 [.04]	3.05 [.12]	DA-15
234A032	42.2 [1.66]	42.2 [1.66]	10.7 [.42]	10.7 [.42]	14.0 [.55]	7.4 [.29]	42.9 [1.69]	27.9 [1.10]	1.02 [.04]	3.05 [.12]	DB-25
234A042	58.7 [2.31]	58.7 [2.31]	10.7 [.42]	10.7 [.42]	17.3 [.68]	8.6 [.34]	53.3 [2.10]	30.5 [1.20]	1.02 [.04]	3.05 [.12]	DC-37
234A052	57.9 [2.28]	57.9 [2.28]	13.7 [.54]	13.7 [.54]	19.1 [.75]	10.7 [.42]	55.9 [2.20]	32.3 [1.27]	1.02 [.04]	3.05 [.12]	DD-50
234A061	20.3 [.80]	20.3 [.80]	10.7 [.42]	10.7 [.42]	7.9 [.31]	3.8 [.15]	25.9 [1.02]	18.5 [.73]	1.02 [.04]	3.05 [.12]	DE-9
234A071	28.2 [1.11]	28.2 [1.11]	10.7 [.42]	10.7 [.42]	10.2 [.40]	5.1 [.20]	30.7 [1.21]	19.8 [.78]	1.02 [.04]	3.05 [.12]	DA-15

Note: Coating is optional. As supplied dimensions appearing in table are for uncoated parts. When coating is added, entry diameters will be reduced by 1.5 (.06) max.

VITON is a trademark of Dupont Dow Elastomers LLC.

Available in:	Americas	Europe	Asia Pacific
	■	■	■

Catalog 1654025
Revised 12-04

www.tycoelectronics.com

Dimensions are in millimeters and inches unless otherwise specified. Values in brackets are U.S. equivalents.

Dimensions are shown for reference purposes only. Specifications subject to change.

USA: 1-800-522-6752
Canada: 1-905-470-4425
Mexico: 01-800-733-8926
C. America: 52-55-5-729-0425

South America: 55-11-3611-1514
Japan: 81-44-900-5102
Singapore: 65-4866-151
UK: 44-1793-528171

D-Subminiature, Side-Entry Boot

As Supplied (a)

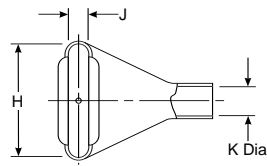

After Unrestricted Recovery (b)

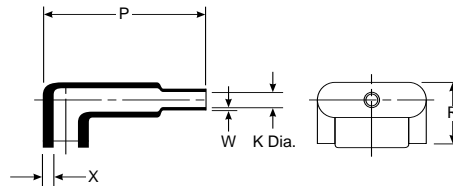
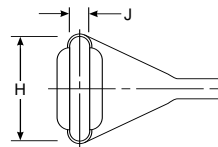

Applications

Provides strain relief and mechanical protection on D-subminiature connector terminations.

Materials Available

Material*	Material Description	Precoating No.	Adhesive Part No.**
-3	Semirigid polyolefin	/42 or /86	S-1017 or S-1048
-4	Flexible polyolefin	/42 or /86	S-1017 or S-1048
-25	Fluid-resistant elastomer	/42 or /86 or /225	S-1017 or S-1048 or S-1125

*For more information, please see the appropriate material page in this section.

**For more information, please see section 5.

Product Dimensions

Part No.	H		J		K		P ±10%	R ±10%	W ±20%	X ±20%	This Boot Fits Cannon/Cinch
	±5% a	±5% b	±5% a	±5% b	Min. a	Max. b					
234A111	20.3 [.80]	20.3 [.80]	10.7 [.42]	10.7 [.42]	7.9 [.31]	4.1 [.16]	27.9 [1.10]	18.5 [.73]	1.02 [.04]	3.05 [.12]	DE-9
234A121	28.2 [1.11]	28.2 [1.11]	10.7 [.42]	10.7 [.42]	10.2 [.40]	5.3 [.21]	35.1 [1.38]	18.8 [.74]	1.02 [.04]	3.05 [.12]	DA-15
234A132	42.2 [1.66]	42.2 [1.66]	10.7 [.42]	10.7 [.42]	14.0 [.55]	6.4 [.25]	47.5 [1.87]	20.1 [.79]	1.02 [.04]	3.05 [.12]	DB-25
234A142	58.7 [2.31]	58.7 [2.31]	10.7 [.42]	10.7 [.42]	17.3 [.68]	7.9 [.31]	59.7 [2.35]	20.1 [.79]	1.02 [.04]	3.05 [.12]	DC-37
234A152	57.9 [2.28]	57.9 [2.28]	13.7 [.54]	13.7 [.54]	19.1 [.75]	9.1 [.36]	63.2 [2.49]	26.4 [1.04]	1.02 [.04]	3.05 [.12]	DD-50

Note: Coating is optional. As supplied dimensions appearing in table are for uncoated parts. When coating is added, entry diameters will be reduced by 1.5 [.06] max.

Available in:	Americas	Europe	Asia Pacific
	■	■	■

D-Subminiature,
90° End-Entry Boot

As Supplied (a)

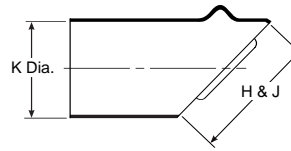

After Unrestricted Recovery (b)

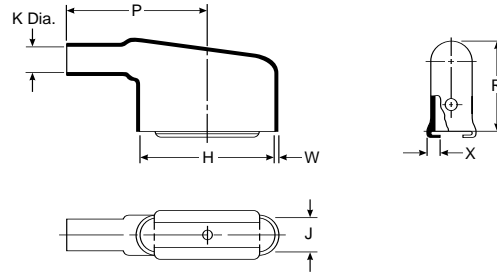

Applications

Provides strain relief and mechanical protection on D-subminiature connector terminations.

Materials Available

Material*	Material Description	Precoating No.	Adhesive Part No.**
-3	Semirigid polyolefin	/42 or /86	S-1017 or S-1048
-4	Flexible polyolefin	/42 or /86	S-1017 or S-1048
-25	Fluid-resistant elastomer	/42 or /86	S-1017 or S-1048 or S-1125

*For more information, please see the appropriate material page in this section.

**For more information, please see section 5.

Product Dimensions

Part No.	H		J		K		P ±10%	R ±10%	W ±20%	X ±20%	This Boot Fits Cannon/Cinch
	±5% a	±5% b	±5% a	±5% b	Min. a	Max. b					
234A611	16.0 [.63]	20.3 [.80]	16.0 [.63]	10.7 [.42]	16.0 [.63]	4.1 [.16]	25.9 [1.02]	21.6 [.85]	1.02 [.04]	3.05 [.12]	DE-9
234A621	19.1 [.75]	28.2 [1.11]	19.1 [.75]	10.7 [.42]	19.1 [.75]	5.3 [.21]	30.7 [1.21]	24.6 [.97]	1.02 [.04]	3.05 [.12]	DA-15
234A632	29.2 [1.15]	42.2 [1.66]	29.2 [1.15]	10.7 [.42]	29.2 [1.15]	7.4 [.29]	42.9 [1.69]	27.9 [1.10]	1.02 [.04]	3.05 [.12]	DB-25
234A642	34.3 [1.35]	58.7 [2.31]	34.3 [1.35]	10.7 [.42]	34.3 [1.35]	8.6 [.34]	53.3 [2.10]	30.5 [1.20]	1.02 [.04]	3.05 [.12]	DC-37
234A652	37.6 [1.48]	57.9 [2.28]	37.6 [1.48]	13.7 [.54]	37.6 [1.48]	10.7 [.42]	55.9 [2.20]	32.3 [1.27]	1.02 [.04]	3.05 [.12]	DD-50
234A661	16.0 [.63]	20.3 [.80]	16.0 [.63]	10.7 [.42]	16.0 [.63]	3.8 [.15]	25.9 [1.02]	18.5 [.73]	1.02 [.04]	3.05 [.12]	DE-9
234A671	19.1 [.75]	28.2 [1.11]	19.1 [.75]	10.7 [.42]	19.1 [.75]	5.1 [.20]	30.7 [1.21]	19.8 [.78]	1.02 [.04]	3.05 [.12]	DA-15

Note: Coating is optional. As supplied dimensions appearing in table are for uncoated parts. When coating is added, entry diameters will be reduced by 1.5 [.06] max.

Available in:	Americas	Europe	Asia Pacific
	■	■	■

242W042 to 63

45° Angled Boot

Applications

Designed for use in the aggressive environments found adjacent to engines in automotive, aerospace and military applications, heat-shrinkable molded parts provide rugged protection, strain relief and a full 360° environmental seal. The introduction of the 45° option means there is now a choice of three routes to the connector for closer positioning and greater design freedom.

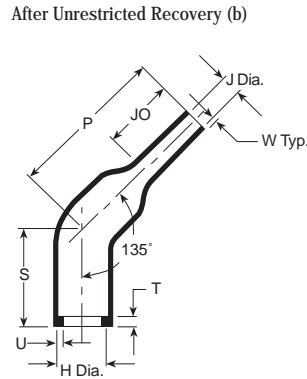
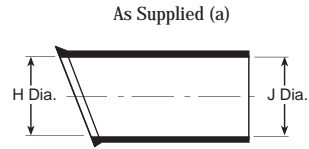

Compatibility Chart

Material Dash Number	Material Description	Precoating No.	Adhesive Part No.
-3	Polyolefin, semirigid	/42, /86	S-1017 or S-1048
-4	Polyolefin, flexible	/42, /86	S-1017 or S-1048
-25	Elastomer, fluid-resistant	/42, /86, /225	S-1017, S-1125 or S-1048
-130	Polyolefin, commercial flexible	/42, /86	S-1017 or S-1048
-12	Viton®	N/A	S-1255-04
-100	Polyolefin, Zerohal	/180	S-1030

Product Dimensions

Part No.	H		J		P ± 10% b	S ± 10% b	T ± 10% b	U ± 10% b	JO ± 10% b	W ± 20% b	
	Min. a	Max. b	Min. a	Max. b							
242W042	31.0 [1.22]	17.9 [0.70]	18.0 [0.71]	31.0 [1.22]	55.0 [2.17]	35.0 [1.38]	3.5 [0.14]	2.0 [0.08]	25.0 [0.98]	1.8 [0.07]	
242W053	36.0 [1.42]	22.1 [0.87]	21.0 [0.83]	36.0 [1.42]	60.0 [2.36]	40.0 [1.58]	3.5 [0.14]	2.0 [0.08]	30.0 [1.18]	2.0 [0.08]	
242W063	43.0 [1.69]	27.9 [1.10]	25.0 [0.99]	43.0 [1.69]	9.9 [0.39]	65.0 [2.56]	45.0 [1.77]	3.5 [0.14]	2.0 [0.08]	35.0 [1.38]	2.2 [0.09]

As supplied dimensions are for uncoated parts, when coating is added, entry diameters will reduce by 1.5 [0.06] max.

Ordering Information

242W0XX-X/XX-0

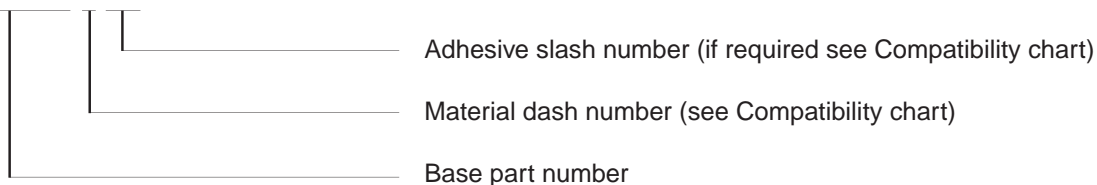

VITON is a trademark of Dupont Dow Elastomers LLC.

Available in:	Americas	Europe	Asia Pacific
	■	■	■

Two-Part Feedthrough

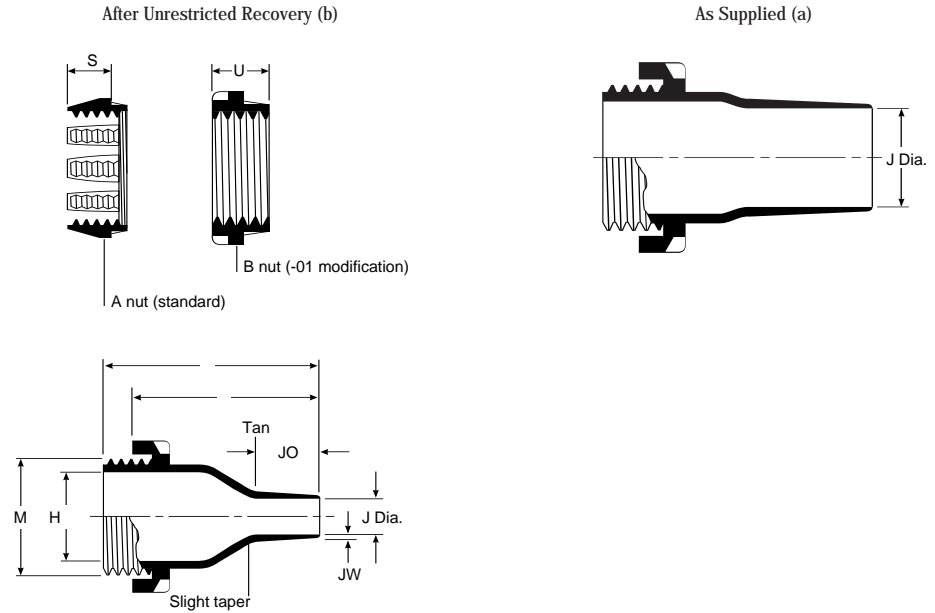

Applications

Use for strain relief and abrasion protection when cables pass through equipment boxes or panels.

Materials Available

Material Dash Number	Material Description	Precoating No.	Adhesive Part No.
-3	Semirigid polyolefin	/42 or /86	S-1017 or S-1048
-4	Flexible polyolefin	/42 or /86	S-1017 or S-1048
-12	Viton®	N/A	S-1255-04
-25	Fluid-resistant elastomer	/42 or /86 or /225	S-1017 or S-1048 or S-1125
-100	Polyolefin, Zerohal	/86 or /180	S-1048 or S-1030

*For more information, please see the appropriate material page in this section.

**For more information, please see section 5.

Product Dimensions

Part No.	H Ref. b	J		JO Max. b	M Thread b	P ±10% b	R ±10% b	S ±10% b	U ±10% b	JW ±20% b	Hole Dia. ±.51 [.02]	
		Min. -3, -4, -12, -25 a	Max. -100 a									
207W213	11.9 [.47]	9.9 [.39]	8.5 [.33]	4.1 [.16]	15.2 [.60]	20.1 [.79]	62.0 [2.44]	49.0 [1.93]	13.0 [.51]	9.9 [.39]	1.3 [.05]	23.9 [.94]
207W223	20.1 [.79]	18.0 [.71]	16.5 [.65]	7.1 [.28]	19.3 [.76]	30.0 [1.18]	71.9 [2.83]	58.9 [2.32]	16.0 [.63]	9.9 [.39]	1.8 [.07]	34.0 [1.34]
207W234	30.1 [1.22]	27.9 [1.10]	26.5 [1.04]	11.9 [.47]	26.9 [1.06]	41.9 [1.65]	87.1 [3.43]	73.9 [2.91]	18.0 [.71]	9.9 [.39]	2.03 [.08]	47.0 [1.85]
207W245	45.0 [1.77]	41.9 [1.65]	40.5 [1.59]	18.0 [.71]	32.0 [1.26]	55.9 [2.20]	102.1 [4.02]	88.9 [3.50]	18.0 [.71]	9.9 [.39]	3.05 [.12]	60.5 [2.38]
207W256	68.1 [2.68]	64.0 [2.52]	64.5 [2.54]	30.0 [1.18]	39.1 [1.54]	80.0 [3.15]	121.9 [4.80]	109.0 [4.29]	18.0 [.71]	9.9 [.39]	3.05 [.12]	85.1 [3.35]

Note: Coating is optional. As supplied dimensions appearing in table are for uncoated parts. When coating is added, entry diameters will be reduced by 1.5 [.06] max.

VITON is a trademark of Dupont Dow Elastomers LLC.

T Transition

As Supplied (a)

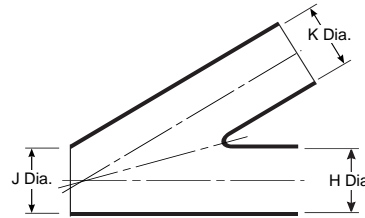

After Unrestricted Recovery (b)

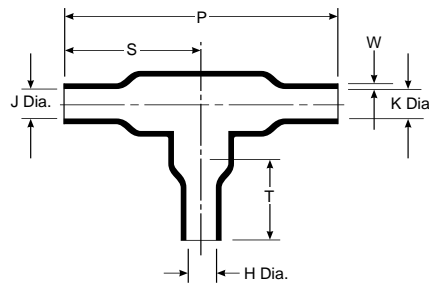

Applications

Provides strain relief and mechanical protection on cable harness assemblies.

Materials Available

Material Dash Number	Material Description	Precoating No.	Adhesive Part No.
-3	Semirigid polyolefin	/42 or /86	S-1017 or S-1048
-4	Flexible polyolefin	/42 or /86	S-1017 or S-1048
-12	Viton®	N/A	S-1255-04
-25	Fluid-resistant elastomer	/42 or /86 or /225	S-1017 or S-1048 or S-1125
-100	Polyolefin, Zerohal	/86, /180	S-1048 or S-1030

*For more information, please see the appropriate material page in this section.

**For more information, please see section 5.

Product Dimensions

Part No.	H, J & K		P ±10% b	S ±10% b	T ±10% b	W ±30% b
	Min. a	Max. b				
301A011	6.6 [.26]	3.6 [.14]	29.7 [1.17]	15.1 [.59]	—	1.02 [.04]
301A022	13.2 [.52]	6.9 [.27]	58.7 [2.31]	29.5 [1.16]	17.5 [.69]	1.52 [.06]
301A028	20.0 [0.79]	10.2 [.40]	90 [3.54]	45 [1.77]	30 [1.18]	2.0 [.08]
301A034	26.9 [1.06]	13.5 [.53]	120.1 [4.73]	60.2 [2.37]	35.6 [1.40]	2.29 [.09]
301A048	55.6 [2.19]	30.2 [1.19]	246.4 [9.70]	123.2 [4.85]	70.9 [2.79]	3.05 [1.12]

Note: Coating is optional. As supplied dimensions appearing in table are for uncoated parts. When coating is added, entry diameters will be reduced by 1.5 [.06] max.

VITON is a trademark of Dupont Dow Elastomers LLC.

Slimline T Transition

As Supplied (a)

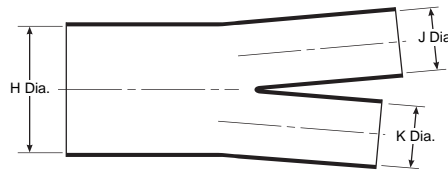

After Unrestricted Recovery (b)

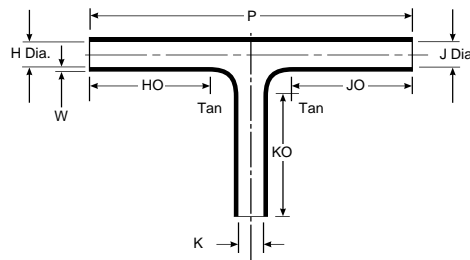

Applications

Provides strain relief and mechanical protection on cable harness assemblies.

Materials Available

Material Dash Number	Material Description	Precoating No.	Adhesive Part No.
-50	Viton® polymer blend	N/A	S-1125
-51	Elastomer polymer blend	/164	S-1124
-71	Flexible polyolefin	/42 or /86	S-1017 or S-1048
-125	Fluoropolymer	N/A	S-1255-04

*For more information, please see the appropriate material page in this section.

**For more information, please see section 5.

Product Dimensions

Part No.	H		J & K		HO, JO, & KO ±10% b	W Nom. b	P Nom. b
	Min. a	Max. b	Min. a	Max. b			
301A511	19.8 [.78]	6.6 [.26]	13.2 [.52]	6.6 [.26]	25.4 [1.00]	1.02 [.04]	80.8 [3.18]
301A512	34.3 [1.35]	11.4 [.45]	22.9 [.90]	11.4 [.45]	41.1 [1.62]	1.27 [.05]	120.4 [4.74]
301A513	60.2 [2.37]	20.1 [.79]	40.1 [1.58]	20.1 [.79]	63.5 [2.50]	1.52 [.06]	175.8 [6.92]
301A514*	83.3 [3.28]	33.3 [1.31]	54.9 [2.16]	33.3 [1.31]	88.9 [3.50]	1.78 [.07]	242.3 [9.54]

Note: Coating is optional. As supplied dimensions appearing in table are for uncoated parts. When coating is added, entry diameters will be reduced by 1.5 [.06] max.

*301A514 is not available in -125 Fluoropolymer material.

VITON is a trademark of Dupont Dow Elastomers LLC.

T Transition

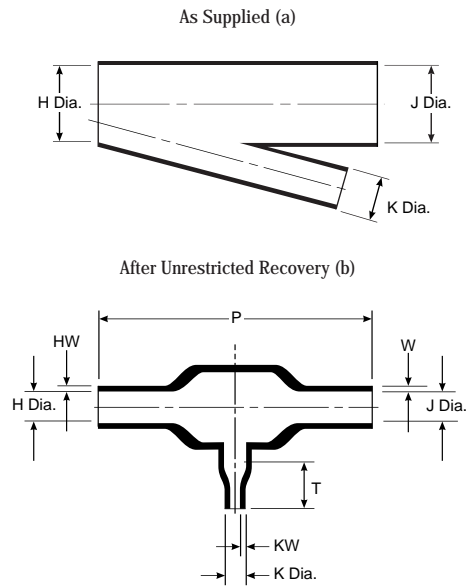

Applications

Provides strain relief and mechanical protection on cable harness assemblies.

Materials Available

Material Dash Number	Material Description	Precoating No.	Adhesive Part No.
-3	Semirigid polyolefin	/42 or /86	S-1017 or S-1048
-4	Flexible polyolefin	/42 or /86	S-1017 or S-1048
-12	Viton®	N/A	S-1255-04
-25	Modified elastomer	/42 or /86 or /225	S-1017 or S-1048 or S-1125
-100	Polyolefin, Zerohal	/86 or /180	S-1048 or S-1030

*For more information, please see the appropriate material page in this section.

**For more information, please see section 5.

Product Dimensions

Part No.	H & J		K		P ±10% b	T ±10% b	HW & W ±20% b	KW ±20% b
	Min. a	Max. b	Min. a	Max. b				
322A112	13.2 [.52]	5.8 [.23]	6.6 [.26]	3.0 [.12]	52.3 [2.06]	—	1.52 [.06]	1.02 [.04]
322A123	26.9 [1.06]	12.4 [.49]	6.6 [.26]	3.0 [.12]	83.3 [3.28]	10.7 [.42]	2.54 [.10]	1.02 [.04]
322A134	26.9 [1.06]	12.7 [.50]	13.2 [.52]	5.8 [.23]	107.7 [4.24]	20.3 [.80]	2.54 [.10]	1.52 [.06]
322A148	55.6 [2.19]	25.4 [1.00]	13.2 [.52]	5.8 [.23]	180.6 [7.11]	25.4 [1.00]	4.57 [.18]	1.52 [.06]
322A158	55.6 [2.19]	25.4 [1.00]	26.9 [1.06]	12.4 [.49]	222.3 [8.75]	38.1 [1.50]	4.57 [.18]	2.54 [.10]

Note: Coating is optional. As supplied dimensions appearing in table are for uncoated parts. When coating is added, entry diameters will be reduced by 1.5 [.06] max.

VITON is a trademark of Dupont Dow Elastomers LLC.

45° Side-Breakout Transition

As Supplied (a)

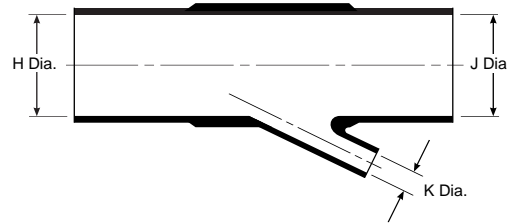

After Unrestricted Recovery (b)

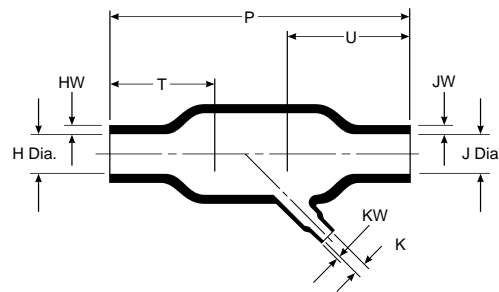

Applications

Provides strain relief and mechanical protection on cable harness assemblies.

Materials Available

Material*	Material Description	Precoating No.	Adhesive Part No.**
-3	Semirigid polyolefin	/42 or /86	S-1017 or S-1048
-4	Flexible polyolefin	/42 or /86	S-1017 or S-1048
-12	Viton®	N/A	S-1255-04
-25	Fluid-resistant elastomer	/42 or /86 or /225	S-1017 or S-1048 or S-1125
-100	Polyolefin, Zerohal	/86 or /180	S-1048 or S-1030

*For more information, please see the appropriate material page in this section.
 **For more information, please see section 5.

Product Dimensions

Part No.	H & J		K		P ±10% b	T ±10% b	U ±10% b	HW & JW ±20% b	KW ±20% b
	Min. a	Max. b	Min. a	Max. b					
342A012	13.2 [.52]	6.9 [.27]	6.6 [.26]	3.6 [.14]	49.3 [1.94]	19.6 [.77]	19.6 [.77]	1.52 [.06]	1.02 [.04]
342A024	26.9 [1.06]	12.7 [.50]	6.6 [.26]	3.6 [.14]	92.5 [3.64]	31.8 [1.25]	39.6 [1.56]	2.54 [.10]	1.02 [.04]
342A034	26.9 [1.06]	13.7 [.54]	13.2 [.52]	6.1 [.24]	144.8 [5.70]	50.8 [2.00]	50.8 [2.00]	2.54 [.10]	1.52 [.06]
342A048	55.6 [2.19]	26.9 [1.06]	13.2 [.52]	6.9 [.27]	184.9 [7.28]	63.5 [2.50]	63.5 [2.50]	4.57 [.18]	1.52 [.06]
342A058	55.6 [2.19]	26.9 [1.06]	26.9 [1.06]	13.7 [.54]	203.5 [8.01]	66.0 [2.60]	66.0 [2.60]	4.57 [.18]	2.54 [.10]

Note: Coating is optional. As supplied dimensions appearing in table are for uncoated parts. When coating is added, entry diameters will be reduced by 1.5 [.06] max.

VITON is a trademark of Dupont Dow Elastomers LLC.

30° Side-Breakout Transition

As Supplied (a)

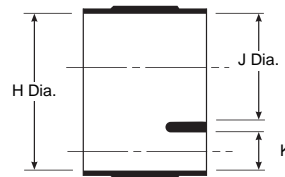

After Unrestricted Recovery (b)

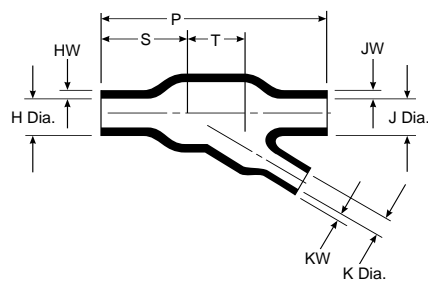

Applications

Provides strain relief and mechanical protection on cable harness assemblies.

Materials Available

Material*	Material Description	Precoating No.	Adhesive Part No.**
-3	Semirigid polyolefin	/42 or /86	S-1017 or S-1048
-4	Flexible polyolefin	/42 or /86	S-1017 or S-1048
-12	Viton®	N/A	S-1255-04
-25	Fluid-resistant elastomer	/42 or /86 or /225	S-1017 or S-1048 or S-1125
-100	Polyolefin, Zerohal	/86 or /180	S-1048 or S-1030

*For more information, please see the appropriate material page in this section.

**For more information, please see section 5.

Product Dimensions

Part No.	H & J		K		P ±10% b	S ±10% b	T ±10% b	HW & JW ±20% b	KW ±20% b
	Min. a	Max. b	Min. a	Max. b					
362A014	30.5 [1.20]	15.7 [.62]	20.3 [.80]	10.7 [.42]	82.6 [3.25]	31.8 [1.25]	21.1 [.63]	2.54 [.10]	1.78 [.07]
362A024	35.6 [1.40]	18.3 [.72]	15.2 [.60]	8.6 [.34]	63.5 [2.50]	19.1 [.75]	22.4 [.88]	2.54 [.10]	1.52 [.06]
362A114	35.6 [1.40]	18.8 [.74]	10.2 [.40]	5.3 [.21]	61.0 [2.40]	19.1 [.75]	21.3 [.84]	2.79 [.11]	1.52 [.06]

Note: Coating is optional. As supplied dimensions appearing in table are for uncoated parts. When coating is added, entry diameters will be reduced by 1.5 [.06] max.

VITON is a trademark of Dupont Dow Elastomers LLC.

Slimline Y Transition

As Supplied (a)

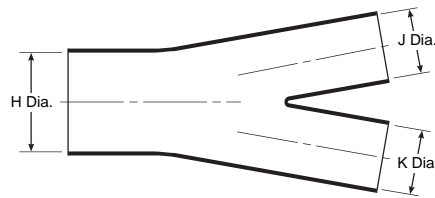

After Unrestricted Recovery (b)

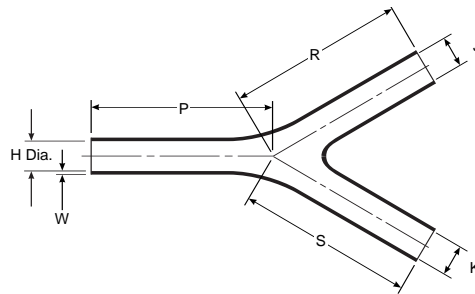

Applications

Provides strain relief and mechanical protection on cable harness assemblies.

Materials Available

Material*	Material Description	Precoating No.	Adhesive Part No.**
-50	Viton® polymer blend	N/A	S-1125
-51	Elastomer polymer blend	/164	S-1124
-71	Flexible polyolefin	/42 or /86	S-1017 or S-1048
-125	Fluoropolymer	—	S-1255-04

*For more information, please see the appropriate material page in this section.
**For more information, please see section 5.

Product Dimensions

Part No.	H		J & K		W Nom. b	P Nom. b	R & S Nom. b
	Min. a	Max. b	Min. a	Max. b			
381A301	19.8 [.78]	6.6 [.26]	13.2 [.52]	6.6 [.26]	1.0 [.04]	40.6 [1.60]	40.6 [1.60]
381A302	34.3 [1.35]	11.4 [.45]	22.9 [.90]	11.4 [.45]	1.3 [.05]	63.0 [2.48]	63.0 [2.48]
381A303	60.2 [2.37]	20.1 [.79]	40.1 [1.58]	20.1 [.79]	1.5 [.06]	94.7 [3.73]	94.7 [3.73]
381A304*	83.3 [3.28]	33.3 [1.31]	54.9 [2.16]	33.3 [1.31]	1.8 [.07]	133.9 [5.27]	133.9 [5.27]

Note: Coating is optional. As supplied dimensions appearing in table are for uncoated parts. When coating is added, entry diameters will be reduced by 1.5 [.06] max.

*381A304 is not available in -125 Fluoropolymer material.

VITON is a trademark of Dupont Dow Elastomers LLC.

Y Transition

As Supplied (a)

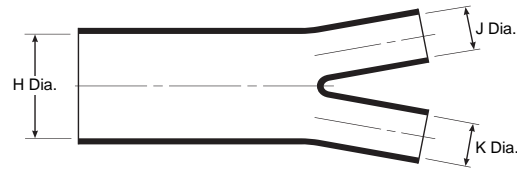

After Unrestricted Recovery (b)

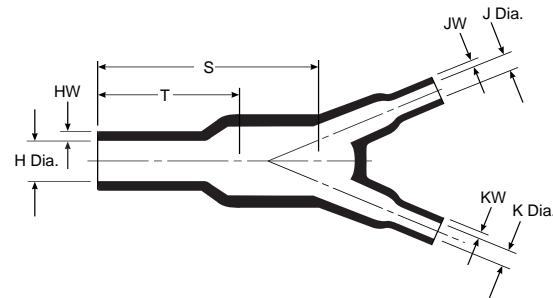

Applications

Provides strain relief and mechanical protection on cable harness assemblies.

Materials Available

Material*	Material Description	Precoating No.	Adhesive Part No. **
-3	Semirigid polyolefin	/42 or /86	S-1017 or S-1048
-4	Flexible polyolefin	/42 or /86	S-1017 or S-1048
-12	Viton®	N/A	S-1255-04
-25	Fluid-resistant elastomer	/42 or /86 or /225	S-1017 or S-1048 or S-1125
-100	Polyolefin, Zerohal	/86 or /180	S-1048 or S-1030

*For more information, please see the appropriate material page in this section.

**For more information, please see section 5.

Product Dimensions

Part No.	H		J & K		S ±10% b	T ±10% b	HW ±20% b	JW & KW ±20% b
	Min. a	Max. b	Min. a	Max. b				
382A012	13.2 [.52]	6.1 [.24]	6.6 [.26]	3.3 [.13]	23.9 [.94]	15.5 [.61]	1.52 [.06]	1.02 [.04]
382A023	26.9 [1.06]	12.4 [.49]	13.2 [.52]	6.1 [.24]	53.3 [2.10]	33.0 [1.30]	2.54 [.10]	1.52 [.06]
382A034	38.6 [1.52]	18.0 [.71]	26.9 [1.06]	12.4 [.49]	78.7 [3.10]	55.9 [2.20]	3.05 [.12]	2.54 [.10]
382A046	55.6 [2.19]	25.9 [1.02]	26.9 [1.06]	12.7 [.50]	111.8 [4.40]	71.1 [2.80]	4.57 [.18]	2.54 [.10]

Note: Coating is optional. As supplied dimensions appearing in table are for uncoated parts. When coating is added, entry diameters will be reduced by 1.5 [.06] max.

VITON is a trademark of Dupont Dow Elastomers LLC.

Slimline Y Transition

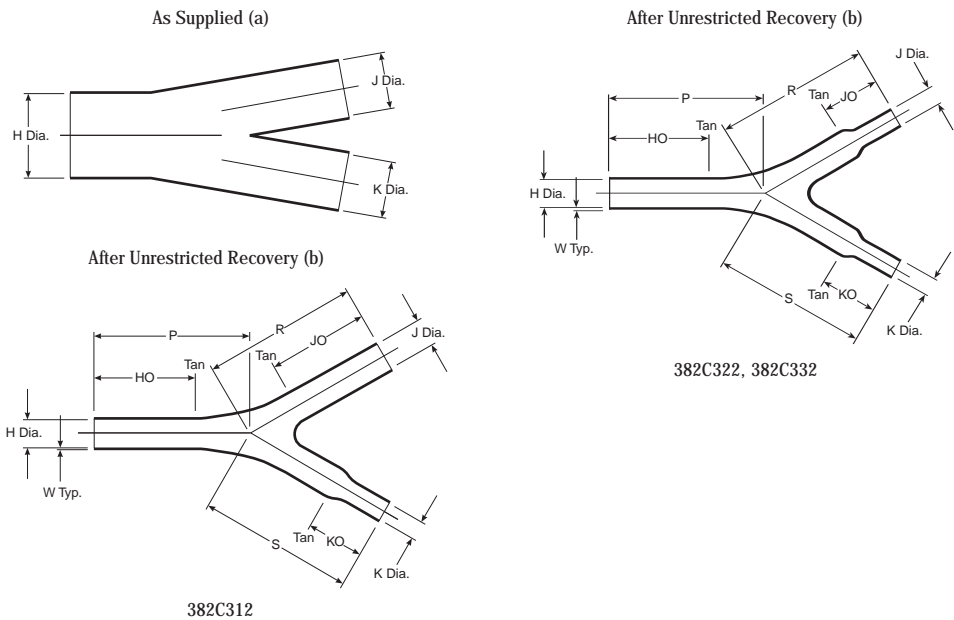

Applications

Provides strain relief and mechanical protection at two into one Y junctions in cable harness assemblies.

When used with adhesive it provides environmental sealing. These parts are based on the 382A3 range. They have the branched

outlet(s) reduced in size to accommodate smaller cable diameters without the need for packing or shimming.

Materials Available

Material	Material Description	Precoating No.	Adhesive Part No.
-50	Viton® polymer blend	N/A	S-1125
-51	Elastomer polymer blend	/164	S-1124
-71	Flexible polyolefin	/42 or /86	S-1017 or S-1048
-125	Fluoropolymer	N/A	S-1255-04

Product Dimensions

Part No.	H		J		K		P, R & S Nom. b	KO ±15% b	HO & JO ±15% b	W Nom. b
	Min. a	Max. b	Min. a	Max. b	Min. a	Max. b				
382C312	1.20 [30.5]	.45 [11.4]	.90 [22.9]	.45 [11.4]	.60 [15.2]	.30 [7.6]	2.48 [63.0]	.85 [21.6]	1.62 [41.1]	.04 [1.0]

Part No.	H		J & K		P, R & S Nom. b	HO ±15% b	JO & KO ±15% b	W Nom. b
	Min. a	Max. b	Min. a	Max. b				
382C322	.90 [22.9]	.45 [11.4]	.40 [10.2]	.20 [5.1]	2.48 [63.0]	1.62 [41.1]	.85 [21.6]	.04 [1.0]

Part No.	H		J & K		P, R & S Nom. b	HO ±15% b	JO & KO ±15% b	W Nom. b
	Min. a	Max. b	Min. a	Max. b				
382C332	1.00 [25.4]	.45 [11.4]	.60 [15.2]	.30 [7.5]	2.48 [63.0]	1.62 [41.1]	.85 [21.6]	.04 [1.0]

Note: Coating is optional. As supplied dimensions appearing in table are for uncoated parts. When coating is added, entry diameters will be reduced by 1.5 [.06] max.

VITON is a trademark of Dupont Dow Elastomers LLC.

Transition, One to Three Cables

As Supplied (a)



After Unrestricted Recovery (b)

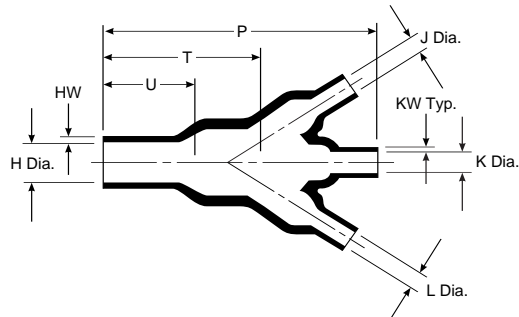

Applications

Provides strain relief and mechanical protection on cable harness assemblies.

Materials Available

Material*	Material Description	Precoating No.	Adhesive Part No.**
-3	Semirigid polyolefin	/42 or /86	S-1017 or S-1048
-4	Flexible polyolefin	/42 or /86	S-1017 or S-1048
-12	Viton®	N/A	S-1255-04
-25	Fluid-resistant elastomer	/42 or /86 or /225	S-1017 or S-1048 or S-1125
-100	Polyolefin, Zerohal	/86 or /180	S-1048 or S-1030

*For more information, please see the appropriate material page in this section.
 **For more information, please see section 5.

Product Dimensions

Part No.	H		J, K&L		P ±10% b
	Min. a	Max. b	Min. a	Max. b	
462A011	13.2 [.52]	6.6 [.26]	6.6 [.26]	3.6 [.14]	46.2 [1.82]
462A023	26.9 [1.06]	13.2 [.52]	13.2 [.52]	6.9 [.27]	93.2 [3.67]
462A034	38.6 [1.52]	18.8 [.74]	19.3 [.76]	9.7 [.38]	135.1 [5.32]
462A046	55.6 [2.19]	25.4 [1.00]	26.9 [1.06]	12.4 [.49]	192.0 [7.56]
462A060	91.4 [3.60]	54.6 [2.15]	45.7 [1.80]	27.4 [1.08]	390.4 [15.37]

Part No.	T ±10% b	U ±10% b	HW ±20% b	KW ±10% b
462A011	30.5 [1.20]	15.7 [.62]	1.52 [.06]	1.02 [.04]
462A023	57.2 [2.25]	33.0 [1.30]	2.54 [.10]	1.52 [.06]
462A034	88.9 [3.50]	45.7 [1.80]	3.05 [.12]	1.78 [.07]
462A046	121.9 [4.80]	71.1 [2.80]	4.57 [.18]	3.05 [.12]
462A060	254.0 [10.00]	127.0 [5.00]	7.11 [.28]	4.57 [.18]

Note: Coating is optional. As supplied dimensions appearing in table are for uncoated parts. When coating is added, entry diameters will be reduced by 1.5 [.06] max.

VITON is a trademark of Dupont Dow Elastomers LLC.

Slimline Transition, One to Three Cables

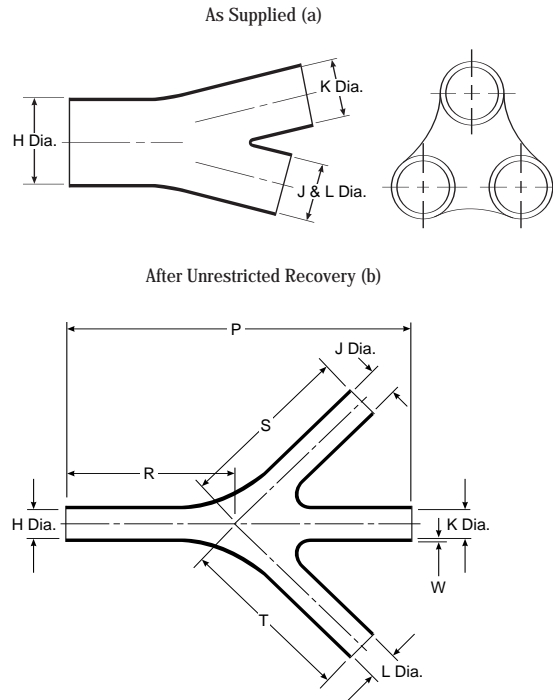

Applications

Provides strain relief and mechanical protection on cable harness assemblies.

Materials Available

Material*	Material Description	Precoating No.	Adhesive Part No.**
-50	Viton® polymer blend	N/A	S-1125
-51	Elastomer polymer blend	/164	S-1124
-71	Flexible polyolefin	/42 or /86	S-1017 or S-1048

Product Dimensions

Part No.	H		J, K & L		W Nom. b	P Nom. b	R, S & T Nom. b
	Min. a	Max. b	Min. a	Max. b			
462A421	19.8 [.78]	6.6 [.26]	13.2 [.52]	6.6 [.26]	1.0 [.04]	85.9 [3.38]	42.9 [1.69]
462A422	34.3 [1.35]	11.4 [.45]	20.6 [.81]	11.4 [.45]	1.3 [.05]	135.6 [5.34]	67.8 [2.67]
462A423	60.2 [2.37]	20.1 [.79]	36.1 [1.42]	20.1 [.79]	1.5 [.06]	207.3 [8.16]	103.6 [4.08]
462A424*	99.8 [3.93]	33.3 [1.31]	54.9 [2.16]	33.3 [1.31]	1.8 [.07]	207.2 [8.16]	103.6 [4.08]

*-01 modification only

Materials Available

Material*	Material Description	Precoating No.	Adhesive Part No.**
-125	Fluoropolymer	—	S-1255-04

*For more information, please see the appropriate material page in this section.

**For more information, please see section 5.

Product Dimensions

Part No.	H		J, K & L		W Nom. b	P Nom. b	R, S & T Nom. b
	Min. a	Max. b	Min. a	Max. b			
462A421	19.8 [.78]	6.6 [.26]	13.2 [.52]	6.6 [.26]	1.0 [.04]	85.9 [3.38]	42.9 [1.69]
462A422	34.3 [1.35]	11.4 [.45]	20.6 [.81]	11.4 [.45]	1.3 [.05]	135.6 [5.34]	67.8 [2.67]
462A423	60.2 [2.37]	20.1 [.79]	36.1 [1.42]	20.1 [.79]	1.5 [.06]	207.3 [8.16]	103.6 [4.08]

Note: Coating is optional. As supplied dimensions appearing in table are for uncoated parts. When coating is added, entry diameters will be reduced by 1.5 [.06] max.

VITON is a trademark of Dupont Dow Elastomers LLC.

Transition, One to Four Cables

As Supplied (a)

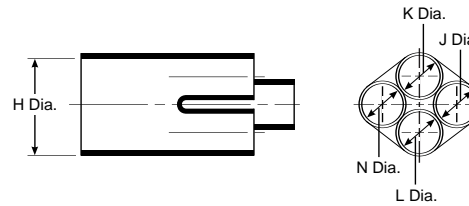

After Unrestricted Recovery (b)

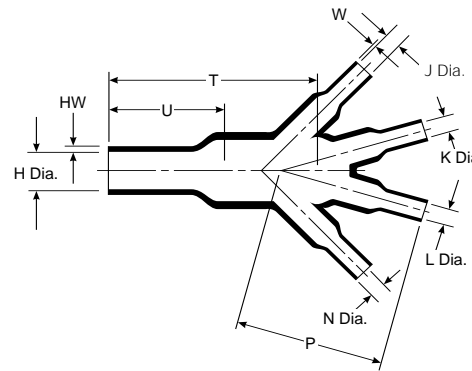

Applications

Provides strain relief and mechanical protection on cable harness assemblies.

Materials Available

Material*	Material Description	Precoating No.	Adhesive Part No.**
-3	Semirigid polyolefin	/42 or /86	S-1017 or S-1048
-4	Flexible polyolefin	/42 or /86	S-1017 or S-1048
-12	Viton®	N/A	S-1255-04
-25	Fluid-resistant elastomer	/42 or /86 or /225	S-1017 or S-1048 or S-1125
-100	Polyolefin, Zerohal	/86 or /180	S-1048 or S-1030

*For more information, please see the appropriate material page in this section.

**For more information, please see section 5.

Product Dimensions

Part No.	H		J, K, L & N		P ±10% b	T ±10% b	U ±10% b	HW ±20% b	W ±20% b
	Min. a	Max. b	Min. a	Max. b					
562A011	13.2 [.52]	6.9 [.27]	6.6 [.26]	3.4 [.14]	24.1 [.95]	43.9 [1.73]	18.0 [.71]	1.52 [.06]	1.02 [.04]
562A022	19.3 [.76]	9.7 [.38]	9.4 [.37]	5.3 [.21]	35.6 [1.40]	43.2 [1.70]	23.1 [.91]	1.78 [.07]	1.02 [.04]
562A032	19.3 [.76]	9.7 [.38]	13.2 [.52]	6.9 [.27]	49.3 [1.94]	50.5 [1.99]	25.4 [1.00]	1.78 [.07]	1.52 [.06]
562A043	26.9 [1.06]	13.0 [.51]	13.2 [.52]	6.9 [.27]	49.3 [1.94]	65.8 [2.59]	33.5 [1.32]	2.54 [.10]	1.52 [.06]
562A054	38.6 [1.52]	18.5 [.73]	19.3 [.76]	9.7 [.38]	71.9 [2.83]	95.3 [3.75]	46.5 [1.83]	3.05 [.12]	1.78 [.07]
562A067	55.6 [2.19]	26.7 [1.05]	26.9 [1.06]	13.0 [.51]	101.6 [4.00]	135.1 [5.32]	65.5 [2.58]	4.57 [.18]	2.54 [.10]

Note: Coating is optional. As supplied dimensions appearing in table are for uncoated parts. When coating is added, entry diameters will be reduced by 1.5 [.06] max.

VITON is a trademark of Dupont Dow Elastomers LLC.

Configurable Heat-Shrink Transition

Product Facts

- Configurable heat-shrink transition
- Low cost commercial polyolefin
- 80°C [176°F] shrink temperature
- High shrink ratio
- Specially engineered easy-to-use crimp tool

QFT

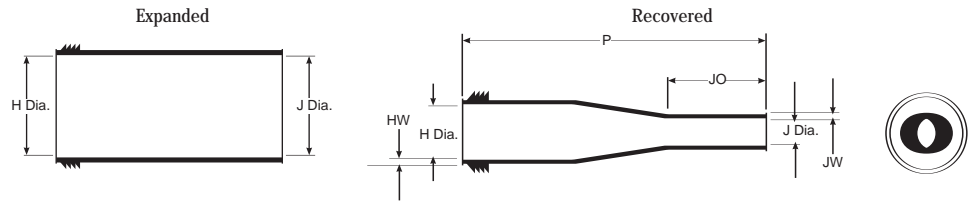

Applications

QFT heat-shrinkable transitions form a watertight seal protecting cable splices from corrosion and mechanical abuse while providing excellent electrical insulating properties. QFT products use special crimps that allow

them to be employed as 1:2, 1:3, and even 1:4 transitions. With their high shrink ratio and crimps the configurable QFT product line can accommodate almost all of your transition needs with only 3 product sizes.

Operating Temperature Range

-20°C to 70°C
[-4°F to 158°F]

Specifications/Approvals

Raychem	RW 2008	Molded Part
	RT1050/1	Adhesive

Temperature Ratings

Operating temperature range	-20°C to 70°C [-4°F to 158°F] (125°C [257°F] without sealant)
Minimum recovery temperature	55°C [131°F]
Maximum storage temperature	40°C [104°F]

Dimensions Table

	H		J		P +/- 10%	JO +/- 10%	HW +/- 20%	JW +/- 20%
	Min.	Max.	Min.	Max.				
QFT1	31.0 [1.22]	9.0 [.35]	31.0 [1.22]	4.4 [.17]	60.0 [2.36]	12.0 [.47]	1.5 [.06]	1.0 [.039]
QFT2	43.0 [1.69]	14.0 [.55]	43.0 [1.69]	7.0 [.28]	75.0 [2.95]	18.0 [.71]	1.8 [.07]	1.0 [.039]
QFT3	57.0 [2.24]	24.0 [.95]	57.0 [2.24]	12.0 [.47]	90.0 [3.53]	25.0 [.98]	1.8 [.07]	1.0 [.039]

Typical QFT Performance

Transitions

QFT (Continued)

	Property	Performance	Test method
Physical	Tensile strength	10 MPa (1500psi) minimum	ISO 37
	Ultimate elongation	250% minimum	ISO 37
	Longitudinal change	0 to 20% maximum	ISO 1183
	Specific gravity	1.4 maximum	ISO 1183
	Heat aging 168 hours at 120°C [248°F]	Minimum 200% ultimate elongation Tensile Strength 10 MPa min.	ISO 188 ISO 37
	Heat shock 4 hours at 105°C	No cracking, dripping or flowing	ASTM D 2671
Electrical	Dielectric strength	8MV/m minimum	IEC 243-1
	Fluid resistance 1 Engine Oil	(24 +/- 2h immersion at 23C+/- 2C) (SAE 20W/50)	ISO 1817 —
Chemical	Hydraulic Fluid Tensile Strength	10 MPa minimum	ISO 37
	Ultimate Elongation	200% minimum	—
	Fluid resistance 2	(30 +/- 3m immersion at 23C+/- 2C)	ISO 1817
	Automotive gasoline	(BS 4040)	—
	Diesel fuel	(BS 2869)	—
	Cleaning fluid	(TL 6850-07)	—
	Antifreeze	(Ethylene Glycol/Water 50/50 v/v)	—
	Engine cleaning fluid Tensile strength	(Gunk) 10 MPa minimum	ISO 37
	Ultimate elongation	200% minimum	—

Part Numbering System

QFT3 - 130/42 - 0*

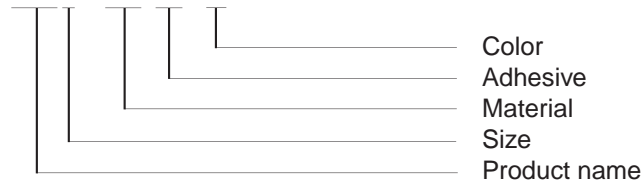

*Available in bulk pack, part number QFT3-130/42-0-B500 (US and UK).

Ordering Information

Color	Standard Code	Black (-0) 0
Packaging	Standard	10 pieces per bag, 30 clips
	Bulk pack	500 pieces per box and 500 clips per bag (clips ordered separately) - contact Tyco Electronics for details
Crimp tool	QFT-Crimp-Tool-Manual (069172-000)	

Heavy Duty Breakout Boots

Product Facts

- Watertight
- Easy installation, requiring no special skills
- Compatibility with polyethylene, PVC, lead, steel, aluminum, standard Navy cable jackets, and copper wire and cable
- Four configurations and twelve sizes
- Minimum shrink temperature of 121°C [250°F]
- Type approval by:
 - ABS (American Bureau of Shipping)
 - DNV (Det Norske Veritas)
 - Lloyd's (Lloyd's Register of Shipping)



Applications

These flame-retardant heat-shrinkable transitions are especially designed for shipboard applications and meet or exceed all of the U.S. Navy specifications described in MIL-I-81765/1A (as of 5/02). The transitions are made of a rugged, thermally stabilized, modified polyolefin and factory-

coated with a thermoplastic adhesive sealant. As a result, they offer excellent water sealing, mechanical abrasion-protection, corrosion-resistance, weatherproofing, and electrical insulation. The transitions replace tapes, epoxies, and grease in applications involving cable breakouts, transitions, and terminations.

SSB, D, T, F to 8S (Continued)

Commercial	Military
RW-2024	MIL-STD-2003
	MIL-I-81765/1A

Product Dimensions

Description	Number of Legs	ID Base		ID legs		Leg	Length Body
		Min. Exp.	Max. Rec.	Min. Exp.	Min. Rec.		
SSB-1202 FR	2	40.64[1.60]	11.43 [0.45]	13.97[0.55]	3.81[0.15]	36.83[1.45]	62.23[2.45]
SSB-2002 FR	2	50.8[2.00]	35.56[1.40]	19.05[0.75]	8.89[0.35]	69.85[2.75]	88.90[3.50]
D3-9 FR	2	20.32[0.80]	9.39[0.37]	8.38[0.33]	2.79[0.11]	17.78[0.7]	50.8[2]
D14-30 FR	2	30.48[1.2]	15.24[0.6]	12.7[0.5]	4.32[0.17]	25.4[1]	63.5[2.5]
D50-100 FR	2	48.26[1.9]	22.86[0.9]	19.05[0.75]	7.62[0.3]	30.48[1.2]	76.2[3]
D200-400 FR	2	76.2[3]	38.1[1.5]	36.83[1.45]	12.7[0.5]	38.1[1.5]	88.9[3.5]
T3-9 FR	3	22.86[0.9]	9.14[0.36]	8.38[0.33]	2.29[0.09]	19.05[0.75]	50.80[2.0]
T14-23 FR	3	30.48[1.2]	17.78[0.70]	12.70[0.5]	4.57[0.18]	25.4[1]	60.96[2.40]
T14-50 FR	3	38.1[1.5]	12.7[0.5]	16.51[0.65]	4.06[0.16]	30.48[1.2]	76.2[2.3]
T42-100 FR	3	43.18[1.7]	22.86[0.9]	20.32[0.8]	4.83[0.19]	30.48[1.25]	57.15[2.25]
T150-300 FR	3	60.96[2.4]	35.56[1.4]	30.48[1.25]	12.70[0.5]	40.6[1.6]	88.90[3.50]
T400 FR	3	81.28[3.2]	50.8[2]	35.56[1.4]	17.78[0.7]	40.6[1.6]	88.9[3.5]
T500-600 FR	3	124.46[4.90]	58.93[2.32]	50.8[2]	22.86[0.9]	50.8[2]	187.96[7.40]
F3-9 FR	4	22.86[0.9]	10.92[0.43]	7.11[0.28]	2.79[0.11]	19.05[0.75]	50.8[2]
F-23 FR	4	31.75[1.25]	20.32[0.8]	12.7[0.5]	5.08[0.2]	27.94[1.1]	63.50[2.50]
F42-60 FR	4	44.45[1.75]	25.4[1]	20.32[0.8]	8.13[0.32]	30.48[1.25]	63.50[2.50]
F75-100 FR	4	59.69[2.35]	25.4[1]	25.4[1]	8.89[0.35]	43.18[1.7]	165.1[6.5]
F133-200 FR	4	67.31[2.65]	35.56[1.4]	30.48[1.2]	10.92[0.43]	38.1[1.5]	91.44[3.6]
F150-400 FR	4	133.35[5.25]	76.2[3]	34.29[1.35]	13.97[0.55]	76.2[3]	152.4[6]
6S100-200 FR	6	60.96[2.4]	36.83[1.45]	20.32[0.8]	8.89[0.35]	69.85[2.75]	86.36[3.4]
8S23-75 FR	8	35.56[1.4]	21.59[0.85]	10.16[0.4]	3.3[0.13]	30.48[1.25]	50.8[2]
8S14-50 FR	8	57.15[2.25]	21.59[0.85]	14.22[0.56]	3.3[0.13]	30.48[1.25]	50.8[2]
8S42-100 FR	8	63.50[2.50]	21.59[0.85]	22.1[0.87]	3.3[0.13]	30.48[1.25]	50.8[2]

Heat-Shrink Bobbins

Product Facts

- Fast installation
- Temperature range of -40°C to 105°C [-40°F to 221°F]
- Fits range of diameters
- Low cost, high volume installation
- Shrinks onto hose/pipe/ wire harnesses
- Good mechanical, thermal and chemical properties
- Good abrasion resistance
- Excellent location, cushioning and protection of cable or hoses from P clips and wire ties
- Stays in place when heated.
- Suits most hoses/pipes/wire harnesses
- No expensive tooling required
- Engine area solution

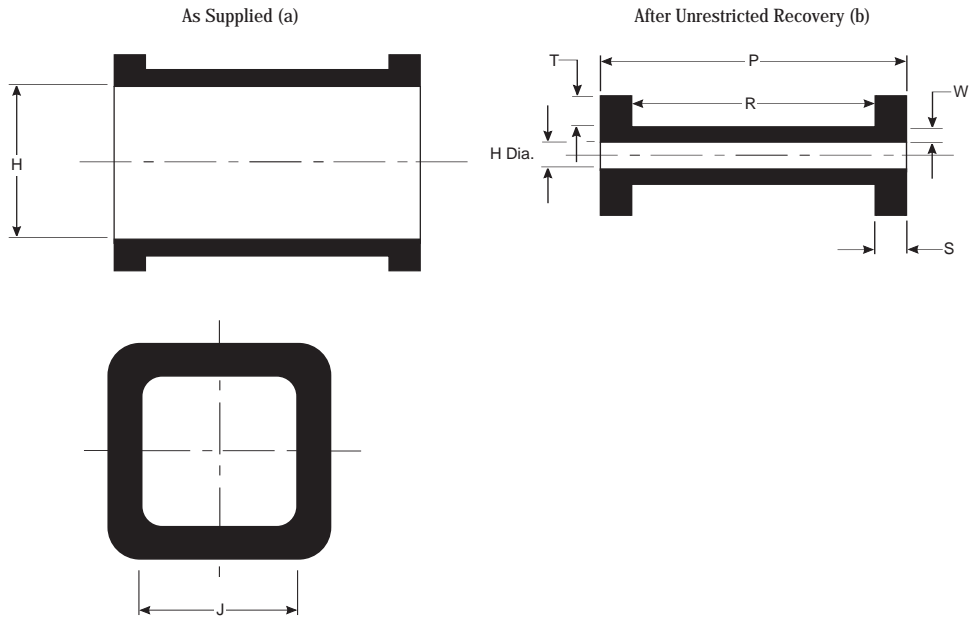
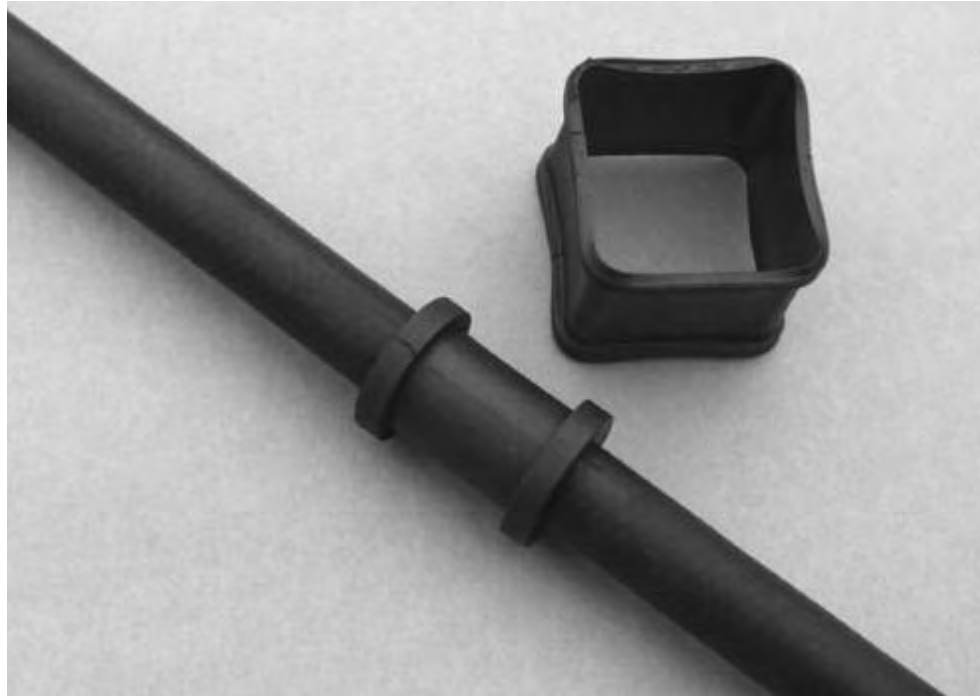

Square expanded = -130 material
 Circular expanded = -12 and -25 material
 -3, -4

Materials Available

202W302 to 342 (Continued)

Material	Material Description	Precoating No.	Adhesive Part No.
-3	Polyolefin, semi-rigid	/42, /86	S-1017, S-1048
-4	Polyolefin, flexible	/42, /86	S-1017, S-1048
-12	Viton®	N/A	S-1255-04
-25	Fluid resistant elastomer	/86 or /225	S-1017 or S-1048 or S-1125
-130	Flexible polyolefin	/42, /86	S-1017

Product Dimensions

Part No.	H		J Min. a	P ±10% b	R ±10% b	S ±10% b	T ±10% b	W ±20% b	Recommended Hose Sizes	
	Min. a	Max. b							Min.	Max.
202W302	29.0 [1.142]	9.5 [.374]	29.0 [1.142]	35.0 [1.378]	25.0 [.984]	5.0 [.197]	3.0 [.118]	1.5 [.059]	11.0 [.433]	25.0 [.984]
202W312	39.0 [1.535]	12.7 [.500]	39.0 [1.535]	35.0 [1.378]	25.0 [.984]	5.0 [.197]	3.0 [.118]	2.0 [.079]	14.0 [.551]	34.0 [1.339]
202W321	10.0 [.394]	3.0 [.118]	10.0 [.394]	29.0 [1.142]	23.0 [.906]	3.0 [.118]	3.0 [.118]	1.5 [.059]	4.0 [.157]	8.0 [.315]
202W331	19.0 [.748]	6.4 [.252]	19.0 [.748]	29.0 [1.142]	24.0 [.945]	2.5 [.098]	2.0 [.079]	1.5 [.059]	8.0 [.315]	17.0 [.669]
202W342	54.0 [2.126]	18.0 [.709]	54.0 [2.126]	35.0 [1.378]	25.0 [.984]	5.0 [.197]	3.0 [.118]	2.0 [.079]	20.0 [.787]	48.0 [1.889]

Note: Coating is optional. As supplied dimensions appearing in table are for uncoated parts. When coating is added, entry diameters will be reduced by 1.5 [.06] max.

VITON is a trademark of Dupont Dow Elastomers LLC.

Electronics

400W242

Heat-Shrink Positioning Ring

Product Facts

- Easy to install
- Close fit to hose/pipe
- Fits range of diameters due to high expansion
- Low cost, high volume installation
- Shrinks onto hose/pipe
- Minimum distance between substrates
- Good mechanical, thermal and chemical properties
- Push on fit to hose/pipe
- Stays in place when installed
- No expensive tooling required
- Positions where needed
- Keeps hoses/pipes together, optimizing space
- Under body solution
- Engine area solution
- Twinning two hoses/pipes rationalizes part descriptions
- Hose/pipe can be orientated correctly for ease of fitting to vehicle



As Supplied (a)

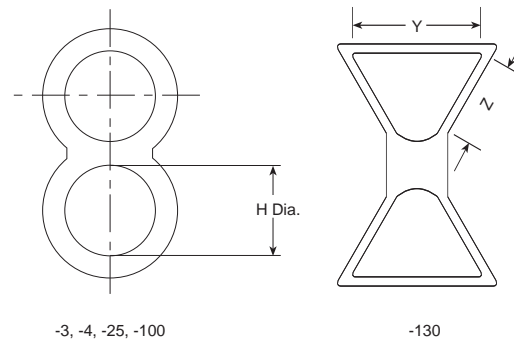

-3, -4, -25, -100

-130

After Unrestricted Recovery (b)

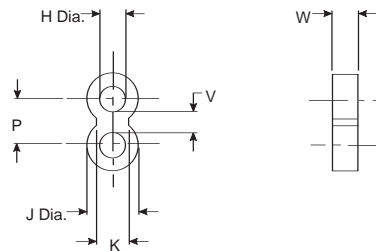

Materials Available

Accessories

400W242 (Continued)

Material	Material Description	Precoating no.	Adhesive part no.
-3	Polyolefin, semi-rigid	/42, /86	S-1017 or S-1048
-4	Polyolefin, flexible	/42, /86	S-1017 or S-1048
-25	Elastomer, fluid resistant	/86, /225	S-1017 or S-1048
-100	Polyolefin, Zerohal	-100-CS1972 (S1030 tape supplied in bag)	S-1030
-130	Flexible polyolefin	/42, /86	S-1017

As supplied dimensions are for uncoated parts, when coating is added, entry diameters will reduce by 1.5 [.06] max.

Part Numbering System

400W242 -/**-0**

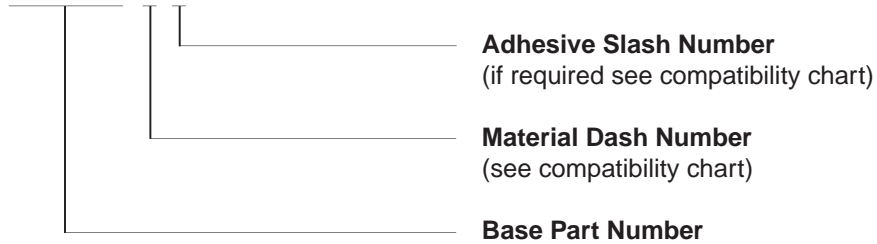

Product Dimensions

Part No.	H		J	K	P	V	W	Y*	Z*
	Min. a	Max. b	Max. b	± 1.2 b	± 1.7 b	± 0.45 b	± 1 b	± 2 a	± 2 a
400W242	28 [1.102]	10.2 [.402]	19.3 [.760]	12 [.472]	17 [.669]	7.0 [.276]	10 [.394]	29 [1.142]	25 [.984]

*Applicable for -130 only.

Heat-Shrinkable Cable Entry Seals

Product Facts

- Comes in many sizes and configurations
- Seals multicable openings
- SAE-AS81765/1 Type 1
- Seals per U.S. Coast Guard HQ 3774 in wet, dry, and corrosive locations



CES



Applications

Raychem Heat-Shrinkable Cable-Entry Seals (CESs) provide a watertight, fume-tight seal where cables enter connection boxes, bulkheads, or other enclosures.

CESs are available in two basic types: standard and threaded. The standard CES for thin-wall enclosures consists of a three-part assembly — a rigid plastic

nylon nut, an O-ring, and a heat-shrinkable molded area. The CES for threaded-hole applications is a one-part assembly that combines a tapered national pipe thread (NPT) in rigid plastic nylon with a heat-shrinkable molded area.

All CESs are available with the molded area configured with one opening for a single wire or cable entry or with two, three, or four legs

of equal size to seal multiple wires or cables at the entry to enclosures and/or bulkheads. To meet sealing requirements, all CESs have factory-applied adhesive that provides the seal to wire and cable jackets. When armored cable is being sealed it may be necessary to use additional sealants, such as G.E. RTV 112 or Dow Corning RTV 732, to form the water seal.

Standard cable entry seal installation instructions

Cable entry seal number	Torque	
	in-pounds	Nm
1	15-20	1.7-2.3
2	15-20	1.7-2.3
3	20-25	2.3-2.8
4	40-45	4.5-5.1
5	45-50	5.1-5.7

Step 1

Place rigid, externally threaded nut through hole so flanged end is on the inside of the can or cabinet.

Step 2

Place O-ring over threaded end and position against outside of can or cabinet.

Step 3

Screw shrinkable, internally threaded component onto the rigid nut and tighten, using appropriate

spanner wrenches, until O-ring is slightly flattened — or use the torque values shown in the table to the left.

Step 4

Insert cable through expanded opening and make necessary connections (see note following Step 4 in the next section).

Step 5

Shrink expanded nose by applying 121°C-135°C [250°F-275°F] of heat from a heat gun with circular reflector, or a gas torch, or other heat source.* When part has shrunk to the cable, and when the sealant is seen to flow, discontinue heat. Additional heating **will not** make the component shrink tighter.

*Follow the safety precautions of the manufacturer of the heater.

Threaded cable entry seal installation instructions

Note: Surfaces to be sealed should be clean and free of burrs, pits, or deep scratches.

Step 1

Apply a thread sealant to the threaded end and then screw threaded cable entry seal into pre-tapped hole or pipe fitting.

Step 2

Tighten by applying wrench to hexagonal nut.

Step 3

Insert cable through expanded opening and make necessary connection (see Note).

Step 4

Shrink expanded nose by applying 121°C-135°C [250°F-275°F] of heat from a heat gun with circular reflector, gas torch, or other heat source.* When part has shrunk to the cable, and when the sealant is seen to flow, discontinue heat. Additional heating **will not** make the component shrink tighter.

Note

If armored cable is used, the factory-applied sealant will not fill

the interstices of the armor. The armor must be cut back so that the part is allowed to shrink and seal to the cable sheath as well as come down over the armor. To keep the armor from unraveling, some armor must be approximately 1/4 inch to 3/8 inch [.01 to .02 mm] inside the cable entry seal leg.

*Follow the safety precautions of the manufacturer of the heater.

CES (Continued)

Standard CES

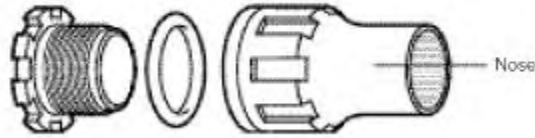

Temperature

Temperature rating	-55°C to 90°C [-67°F to 194°F]
Minimum shrink temperature	121°C [250°F]

Specifications

Type	Raychem	
Molded heat-shrink nose	RT-301	Flame retardant polyolefin
Adhesive	RW-2019	Hot melt adhesive

Product Dimensions

Part No.	No. of Legs	Overall Nom. Recommended Length	Min. Expanded I.D. Nose	Max. Recovered I.D. Nose	Max. I.D. of Part	Drill Size	Max. O.D. of Nut
CES-1	1	69.85 [2.75]	12.70 [0.50]	4.32 [0.17]	19.05 [0.75]	25.40 [1.00]	35.81 [1.410]
CES-2	1	69.85 [2.75]	19.05 [0.75]	6.35 [0.25]	19.05 [0.75]	25.40 [1.00]	35.81 [1.410]
CES-3	1	95.25 [3.75]	28.45 [1.12]	12.70 [0.50]	27.94 [1.10]	35.05 [1.38]	48.31 [1.902]
CES-4	1	114.30 [4.50]	40.64 [1.60]	19.05 [0.75]	39.62 [1.56]	50.80 [2.00]	69.09 [2.720]
CES-4S*	1	114.30 [4.50]	50.80 [2.00]	19.05 [0.75]	53.34 [2.10]	59.94 [2.36]	85.09 [3.350]
CES-5	1	177.80 [7.00]	69.85 [2.75]	36.32 [1.43]	73.66 [2.90]	88.90 [3.50]	103.38 [4.070]

*Part configuration may be different than depicted in figure. Contact Tyco Electronics for specification.

Breakout CES

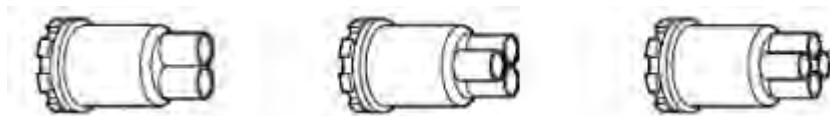

Product Dimensions

Part No.	No. of Legs	Overall Nom. Recommended Length	Min. Expanded I.D. (Each Leg)	Max. Recovered I.D. (Each Leg)	Max. I.D. of Part	Drill Size	Max. O.D. of Nut
CES-2-D1A	2	69.85 [2.75]	15.24 [0.60]	2.79 [0.11]	19.05 [0.75]	25.40 [1.00]	35.81 [1.41]
CES-2-T1	3	69.85 [2.75]	10.16 [0.40]	2.79 [0.11]	19.05 [0.75]	25.40 [1.00]	35.81 [1.41]
CES-2-T1B	3	88.90 [3.50]	15.24 [0.60]	4.32 [0.17]	19.05 [0.75]	25.40 [1.00]	35.81 [1.41]
CES-2-F1A	4	69.85 [2.75]	10.16 [0.40]	2.79 [0.11]	19.05 [0.75]	25.40 [1.00]	35.81 [1.41]
CES-2-F1	4	88.90 [3.50]	15.24 [0.60]	4.32 [0.17]	19.05 [0.75]	25.40 [1.00]	35.81 [1.41]
CES-3-D1	2	88.90 [3.50]	15.24 [0.60]	4.32 [0.17]	27.94 [1.10]	35.05 [1.38]	48.26 [1.90]
CES-3-T1	3	88.90 [3.50]	15.24 [0.60]	4.32 [0.17]	27.94 [1.10]	35.05 [1.38]	48.26 [1.90]
CES-3-F1	4	88.90 [3.50]	15.24 [0.60]	4.32 [0.17]	27.94 [1.10]	35.05 [1.38]	48.26 [1.90]
CES-4-D3	2	101.60 [4.00]	22.86 [0.90]	7.62 [0.30]	40.64 [1.60]	50.80 [2.00]	69.09 [2.72]
CES-4-T1	3	101.60 [4.00]	22.86 [0.90]	7.62 [0.30]	40.64 [1.60]	50.80 [2.00]	69.09 [2.72]
CES-4-F1	4	101.60 [4.00]	22.86 [0.90]	7.62 [0.30]	40.64 [1.60]	50.80 [2.00]	69.09 [2.72]
CES-5-T4	3	127.00 [5.00]	31.75 [1.25]	12.70 [0.50]	73.66 [2.90]	63.50 [2.50]	103.38 [4.07]
CES-5-F4	4	127.00 [5.00]	31.75 [1.25]	12.70 [0.50]	73.66 [2.90]	63.50 [2.50]	103.38 [4.07]

CES (Continued)

Threaded CES

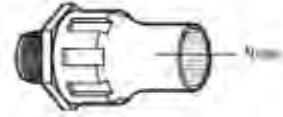

Part No.	Overall Nom. Recommended Length	Min. Expanded I.D. Nose	Max. Recovered I.D. Nose	National Adapter I.D.	Pipe Thread Size
CES-2-A50	83.82 [3.30]	19.05 [0.75]	6.35 [0.25]	12.70 [0.50]	1/2-14
CES-2-A75	83.82 [3.30]	19.05 [0.75]	6.35 [0.25]	19.05 [0.75]	3/4-14
CES-2-A100	83.82 [3.30]	19.05 [0.75]	6.35 [0.25]	19.05 [0.75]	1-11 1/2
CES-3-A100	111.00 [4.37]	28.45 [1.12]	12.70 [0.50]	25.40 [1.00]	1-11 1/2
CES-3-A150	117.35 [4.62]	28.45 [1.12]	12.70 [0.50]	27.94 [1.10]	1 1/2-11 1/2
CES-4A-A150*	127.00 [5.00]	50.80 [2.00]	19.05 [0.75]	35.56 [1.40]	1 1/2-11 1/2
CES-5-A250*	152.40 [6.00]	69.85 [2.75]	25.40 [1.00]	60.96 [2.40]	2 1/2-10

* Not illustrated - refer to Specification Control Drawing for details.

Threaded Breakout CES

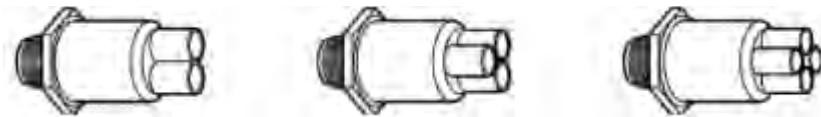

Product Dimensions

Part No.	No. of Legs	Overall Nom. Recommended Length	Min. Expanded I.D. (Each Leg)	Max. Recovered I.D. (Each Leg)	Max. I.D. of Part	Pipe Thread Size (NPT)
CES-2A-T1	3	95.25 [3.75]	10.16 [0.4]	2.79 [0.11]	12.70 [0.50]	1/2-14
CES-2A-F1	4	95.25 [3.75]	10.16 [0.4]	2.79 [0.11]	12.70 [0.50]	1/2-14
CES-2A-D1	2	95.25 [3.75]	15.24 [0.6]	2.79 [0.11]	19.05 [0.75]	3/4-14
CES-2A-T2	3	95.25 [3.75]	10.16 [0.4]	2.79 [0.11]	19.05 [0.75]	3/4-14
CES-2A-F2	4	95.25 [3.75]	10.16 [0.4]	2.79 [0.11]	19.05 [0.75]	3/4-14
CES-3A-D1	2	95.25 [3.75]	15.24 [0.6]	4.32 [0.17]	25.40 [1.00]	1-11 1/2
CES-2A-T3	3	95.25 [3.75]	15.24 [0.6]	4.32 [0.17]	25.40 [1.00]	1-11 1/2
CES-3A-F1	4	95.25 [3.75]	15.24 [0.6]	4.32 [0.17]	25.40 [1.00]	1-11 1/2
CES-3A-D2	2	95.25 [3.75]	15.24 [0.6]	4.32 [0.17]	27.94 [1.10]	1 1/2-11 1/2
CES-3A-T2	3	95.25 [3.75]	15.24 [0.6]	4.32 [0.17]	27.94 [1.10]	1 1/2-11 1/2
CES-3A-F2	4	95.25 [3.75]	15.24 [0.6]	4.32 [0.17]	27.94 [1.10]	1 1/2-11 1/2
CES-4A-D3	2	95.25 [3.75]	22.86 [0.9]	7.62 [0.30]	37.34 [1.47]	1 1/2-11 1/2
CES-4A-T3	3	95.25 [3.75]	22.86 [0.9]	7.62 [0.30]	37.34 [1.47]	1 1/2-11 1/2
CES-4A-F3	4	95.25 [3.75]	22.86 [0.9]	7.62 [0.30]	37.34 [1.47]	1 1/2-11 1/2

Note: Coating is optional. As supplied dimensions appearing in table are for uncoated parts. When coating is added, entry diameters will be reduced by 1.5 [.06] max.

Right-Angle Threaded CES

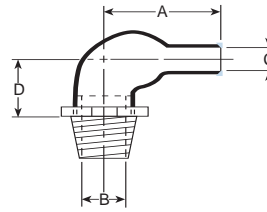

Part No.	C		B ID Min	Length		NPT Size
	Min. Exp. ID	Max. Rec. ID		A	D	
CES-2R-A50	12.70 [0.50]	7.11 [0.28]	12.70 [0.50]	35.56 [1.4]	25.40 [1.00]	1/2-14
CES-2R-A75	18.03 [0.71]	8.38 [0.33]	19.05 [0.75]	43.18 [1.7]	27.94 [1.10]	3/4-14
CES-3R-A100	27.94 [1.10]	9.65 [0.38]	25.40 [1.00]	53.34 [2.1]	33.78 [1.33]	1-11 1/2
CES-3R-A150	40.64 [1.60]	15.75 [0.62]	27.94 [1.10]	78.74 [3.1]	39.62 [1.56]	1 1/2-11 1/2

Right-Angle Breakout CES

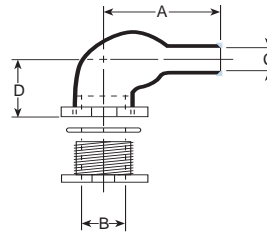

Part No.	C		B ID Min	Length		Drill Size
	Min. Exp. ID	Max. Rec. ID		D	A	
CES-1R	12.70 [0.50]	7.11 [0.28]	12.70 [0.50]	35.56 [1.4]	42.67 [1.68]	25.40 [1.00]
CES-2R	18.03 [0.71]	8.38 [0.33]	19.05 [0.75]	43.18 [1.7]	44.96 [1.77]	25.40 [1.00]
CES-3R	27.94 [1.10]	9.65 [0.38]	27.94 [1.10]	53.34 [2.1]	58.42 [2.30]	34.80 [1.37]
CES-4R	40.64 [1.60]	15.75 [0.62]	40.64 [1.60]	78.74 [3.1]	71.12 [2.80]	50.80 [2.00]

RayOLOn Kits

Roll-On Sealing Sleeve

Product Facts

- A Raychem heatless sealing solution
- Re-useable sealing solution
- Roll-on to seal, roll-off to re-enter
- Enhanced sealing with gel strips
- Protection of connectors and splices against corrosion
- Available in many conveniently packaged kits



Applications

RayOLOn re-useable roll-on sealing sleeves are a family of products designed to protect connectors, electrical cable splices, and other cylindrical substrates from harsh environmental elements like salt spray and water moisture. RayOLOn sleeves are a part of Raychem's "heatless" sealing products that require no

heat guns or torches. This is useful in the areas where the use of motorized heat sources or open flames are prohibited or undesirable.

RayOLOn sealing sleeves provide the sealing of the substrates by simply rolling the sleeve over the area to be protected. If the substrate requires servicing, the sleeve can be rolled off to provide access to the

component under the sleeve. After the service is completed, the sleeve can be rolled on the part again to provide the protection. This operation may be done many times throughout the life of the sleeve providing time and material cost savings.

Operating Temperature Range

-40°C to 70°C
[-40°F to 158°F]

Specifications and Approvals

Raychem	RW 3031
---------	---------

Temperature Ratings

Continuous operating temperature range	-40°C to 70°C [-40°F to 158°F]
Short term temperature exposure	-63°C to 90°C [-81°F to 194°F]
Minimum installation	-25°C [-13°F]

Sleeve Dimensions
Inches (millimeters)

Base Part No.	Available Kits	Dimensions (Reference)		Recommended Use Range	Connection Length
		Diameter	Lengths		
LNCL-11-125	GK	0.51 [13.0]	4.92 [125]	0.22 - 0.68 [6 - 17]	3.00 [75]
LNCL-11-205	GK	0.51 [13.0]	8.07 [205]	0.22 - 0.68 [6 - 17]	6.00 [150]
LNCL-12-140	GK, CK-N	0.56 [14.2]	5.51 [140]	0.48 - 0.90 [12 - 23]	4.00 [100]
LNCL-12-240	GK, CK-N	0.56 [14.2]	9.45 [240]	0.48 - 0.90 [12 - 23]	7.00 [175]
LNCL-13-155	GK, TK-8	0.75 [19.0]	6.10 [155]	0.69 - 1.20 [18 - 30]	4.00 [100]
LNCL-13-305	GK	0.75 [19.0]	12.00 [305]	0.69 - 1.20 [18 - 30]	9.00 [225]
LNCL-14-185	GK, TK-7	1.02 [25.9]	7.28 [185]	0.96 - 1.50 [25 - 38]	5.00 [125]
LNCL-14-355	GK	1.02 [25.9]	14.00 [355]	0.96 - 1.50 [25 - 38]	10.0 [250]
LNCL-15-185	GK, TK-1, TK-5, TK-6	1.45 [36.8]	7.28 [185]	1.40 - 2.00 [36 - 46]	5.00 [125]
LNCL-15-260	GK, SS	1.45 [36.8]	10.2 [260]	1.40 - 2.00 [36 - 46]	7.50 [190]
LNCL-15-450	GK, SS	1.45 [36.8]	17.72 [450]	1.40 - 2.00 [36 - 46]	12.0 [300]

Refer to Raychem specification control drawing LNCL-XX-125 thru LNCL-XX-450 for more details.
*Tyco Electronics Gel and Sealant product information available at www.tycoelectronics.com

Typical RayOLOn Roll-On Sealing Sleeve Properties

RayOLOn Kits (Continued)

	Property	Performance	Test method
Physical/ Chemical	Tensile strength	8.3 MPa (1200 psi) minimum	ASTM D 2671
	Ultimate elongation	100 % minimum	ASTM D 412
	Density	1.1 g/cm ³ maximum	ASTM D 792
	Water absorption 24 hours at 23°C [73°F]	0.5 % maximum	ASTM D 570
	Flammability	40 mm/min maximum	ASTM D 635
Electrical	Dielectric strength	90 kV/cm (225 V/mil) minimum	ASTM D 149
	Volume resistivity	1x10 ¹² Ω-cm	ASTM D 257

Refer to Raychem specification RW3031 for more requirements and performance information.

Notes:

1. The sleeve is not intended to be heated during the installation process.
2. DO NOT CUT LNCL roll-on sealing sleeve.
3. In case of a conflict between this data sheet and RW3031, RW3031 takes precedence.
4. Not recommended for extended exposure to hydrocarbon based fuel or fluids.

Part Numbering System

LNCL - XX - XXX - XX - XX

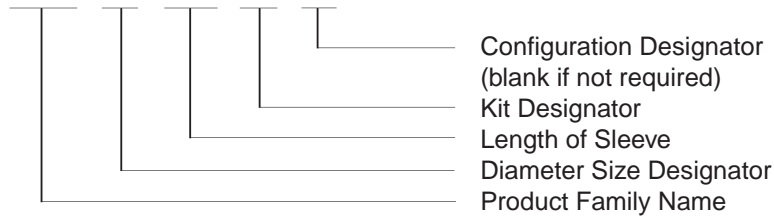

Kits

GK—General kit:	Roll-on sleeve, gel strip, cable tie, core tube, installation instruction
CK—Connector sealing kit:	Roll-on sleeve, cable tie, connector flange cover, gel strip, installation instruction
TK—Panel boot sealing kit:	Roll-on sleeve, ferrule, gel strip, cable tie, installation instruction
SS—Ship-or-shore kit:	Roll-on sleeve, connection shield, installation instruction

Note: Not all sizes and lengths are available for all kit combinations. Please refer to the table on the previous page.

Cable Clamp Heat-Shrink Grommet

Product Facts

- Less assembly time
- Superior strain-relief
- Fewer errors — less rework
- Rework made easier
- No build-up taping or feeding wire through grommet
- Typical installation in just 10-20 seconds
- Re-expandable I.D. allows wire addition to a cable bundle

shrinkHOoP



Applications

shrinkHOoP grommet (URHR) is an ultra high ratio heat-shrinkable-strain-relief grommet that can be placed over the cable assembly after the connector pinning operation is completed. The ultra-high expansion ratio material conveniently fills the space between the clamp type connector accessory and the cable. (When clamped into position, shrinkHOoP grommet provides strain relief that is more consistent and convenient than many conventional practices — for example, taping, grommet, or tape/grommet combination). The high ratio conformity of shrinkHOoP grommets will match most

typical cable configurations from single conductor to the high density multiple conductor arrangements.

With shrinkHOoP grommet, repairs and rework are a snap – simply heat the grommet until soft, slide a NON-METALLIC probe through the center of the wire bundle (enlarging the grommet I.D.). Once cooled, the grommet will remain open allowing wires to be added, removed or reworked. The system can then be checked, the grommet reheated (shrinking it down again), positioned, and clamped in place.

Operating Temperature Range

-55°C to 135°C
[-67°F to 275°F]

shrinkHOoP (Continued)

RW

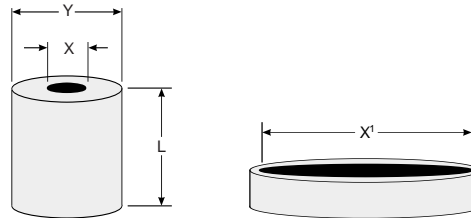

Product Dimensions
Inches (millimeters)

Part No.	I.D. Expanded (X1) min.	I.D. Recovered (X) max.	O.D. (Y) Ref.	Length (L) Ref.	Wt. (gm) Ref.	Notes
URHR-1	1 [25]	.08 [2.1]	0.25 [6]	0.5 [13]	0.75	
URHR-2	1.23 [31]	.10 [2.6]	0.375 [10]	0.5 [13]	1	
URHR-3	1.44 [37]	.14 [3.6]	0.5 [13]	0.5 [13]	1.5	
URHR-4	1.85 [47]	0.18 [4.7]	0.562 [14]	0.75 [19]	3.5	
URHR-5	2 [51]	0.20 [5.1]	0.812 [21]	0.75 [19]	5	

a) Recovered length will allow for 1.91 [0.075] either side of the collar, minimum in most cases.

Typical shrinkHOoP Grommet
Performance

	Property	Performance	Test Method
Physical	Tensile strength	1500 psi (10.3 Mpa)	ASTM D-412
	Ultimate elongation	250% minimum	ASTM D-412
	Specific gravity	1.4 maximum	ASTM D-792
	Water absorption	0.5 % maximum	ASTM D-570 A
	Flammability	Pass	ASTM D-635
	Corrosion resistance	Pass	ASTM D-2671 A
	Low temperature flex 4 hours at - 55+/-1°C [67+/-2°F]	Pass	ASTM D-2671 C
	Heat resistance	200% ultimate elongation, minimum	ASTM D-2671
Elastic Memory	168 hrs at 175+/-1°C [347+/-2°F]	1200 psi (8.3 Mpa) tensile strength, minimum	
	Heat shock 4 hrs at 225+/-2°C [437+/-5°F]	No cracking, dripping or flowing	ASTM D 2671
Electrical	Dielectric strength	275% minimum expansion to 4 inch (10 cm) of a fully recovered test specimen, and 93% recovery of expanded specimen after oven conditioning for 1 minute at 150+/-2°C[302 +/- 4°F]	—
	Volume resistivity	200 v/mil (7880 v/mm) minimum	ASTM D-876
Chemical Fluid Resistance	—	10 14 ohm-cm minimum	ASTM D-257
	Flammability*	200% ultimate Elongation, minimum 1200 psi (8.3 Mpa) tensile strength, minimum	ASTM F-146
		Avg. flame time = 30 sec. max Avg. burn length = 3 in. max. Avg. flame time from drippings = 3 sec. max	FAR part 25, Appendix F, part 1 (a), section 3

*applies to sizes 2, 3, and 4 only

Selection chart

shrinkHOoP (Continued)

Connector Series	Connector Size				
	8 (9)	10, 12 (11, 13)	14, 16 (15, 17)	18, 20 (19, 21)	22, 24, 28*
MIL-C-5015					
MS3451, 52, 56, 59	1	2	3	4	5
MS3450	2	3	4	5	*
MIL-C-26500**					
MS24266	1	2	3	4	5
MS24264, 265	2	3	4	5	*
MIL-C-26482					
MS3120, 21, 22, 26	1	2	3	4	5
MS3470, 71, 74, 75, 76	1	2	3	4	5
MS3124, MS3472	2	3	4	5	*
MIL-C-83723 Series I					
M83723/01 & 02, 05 & 06	1	2	3	4	5
07 & 08, 13 & 14, 23 & 24	1	2	3	4	5
M83723/03 & 04	2	3	4	5	*
MIL-C-83723 Series II					
M83723/17 & 18, 23 & 24	1	2	3	4	5
M83723/12 & 20, 21 & 22	2	3	4	5	*
MIL-C-83723 Series III					
M83723/71 & 72 thru 97 & 98	1	2	3	4	5
M83723/66, 67, 68 & 69	2	3	4	5	*
MIL-C-38999 Series I					
MS27469	1	2	3	4	5
MS27466, 68, 96, 27505, 27656	2	3	4	5	*
MIL-C-38999 Series II					
MS27472, 97, 98, 27508, 27513	1	2	3	4	5
MS27473, 84, 27474	2	3	4	5	*
MIL-C-38999 Series III					
38999/26	1	2	3	4	5
38999/20, 24	3	4	5	5	*
Boeing					
BACC45, F, M, N, P, R, S, T	—	2	3	4	5
BACC 63X	—	3	4	5	*
Boeing					
DC39, 31, 34, 35, 50-57	1	2	3	4	5
DC32, 33, 36, 37, 60, 61, 62, 63	2	3	4	5	*

* Consult Tyco Electronics for availability of larger sizes.

** Note: cable support clamp I.D. may effect the size of shrinkHOoP grommet selected.

Tyco Electronics Corporation has acquired XL Technologies. Use the information in the following table to convert the XL part number into the new Tyco Electronics Raychem product description.



Ordering Information

Description	Convert to
XL Part No.	Description
080EK025	SSC-2/239
080EK025-woA	SSC-2/U
137EK050	SSC-3/239
137EK050-woA	SSC-3/U
1-8117-2A	CES-2A-D1
1-8117-3A	CES-2A-T1
1-8117-4A	CES-2A-F1
200EK075	SSC-4/239
200EK075-woA	SSC-4/U
20432242	CES-4/HR-3
2-8115-2A	CES-2-D1A
2-8115-2AOE	CES-2-D1A
2-8115-2B	CES-2-D1
2-8115-3A	CES-2-T1
2-8115-3B	CES-2-T1B
2-8115-4A	CES-2-F1A
2-8115-4B	CES-2-F1
2-8117-2A	CES-2A-D1
2-8117-2AOE	CES-2A-D1
2-8117-3A	CES-2A-T2
2-8117-4A	CES-2A-F2
2-8118-3A	CES-2-T1
2S-8115-2A	CES-2-D1A
2S-8115-3A	CES-2-T1
2S-8115-4A	CES-2-F1A
380EK150	SSC-6/239
380EK150woA	SSC-6/U
3-8115-2B	CES-3-D1
3-8115-3B	CES-3-T1
3-8115-4B	CES-3-F1
3-8118-4B	CES-3-F1
3A-8117-2B	CES-3A-D1
3A-8117-3B	CES-2A-T3
3A-8117-4B	CES-3A-F1
4-8115-2C	CES-4-D3
4-8115-3C	CES-4-T1
4-8115-4C	CES-4-F1
4-8117-2B	CES-3A-D2
4-8117-3B	CES-3A-T2
4-8117-4B	CES-3A-F2
4A-8117-2C	CES-4A-D3
4A-8117-3C	CES-4A-T3
4A-8117-4C	CES-4A-F3
52451-2X12A	91385-2/12
5-8115-3D	CES-5-T4
8114-1	CES-1
1/2/14	CES-1-2
8114-1-49R	CES-1R
8114-2	CES-2
8114-2-50R	CES-2R
8114-2S	CES-2
8114-2V	CES-2V
8114-2VL	CES-2V
8114-3	CES-3
8114-3-51R	CES-3R
8114-3L	CES-3L
8114-3S	CES-3S
8114-4	CES-4
8114-4-54R	CES-4R
8114-4N	CES-4
8114-4S	CES-4S

Description	Convert to
XL Part No.	Description
8114-4S/C	CES-4S
8114-5	CES-5
8116-1	CES-2-A50
8116-1-49R	CES-2R-A50
8116-1A	CES-2-A50
8116-2	CES-2-A75
8116-2-50R	CES-2R-A75
8116-3	CES2-A100
8116-3-51R	CES-3R-A100
8116-3A	CES-3-A100
8116-4	CES-3-A150
8116-4-52R	CES-3R-A150
8116-4A	CES-4A-A150
8116-5	CES-5-A250
8118-2	CES-2
91342-1	D3-9 FR
91342-12	D3-30 FR
91342-2	D14-30 FR
91342-23	D14-100 FR
91342-3X2.5	D50-200 FR
91342-3	D50-100 FR
91342-34	D50-400 FR
91342-4	D200-400 FR
91343-1	T3-9 FR
91343-2	T14-23 FR
91343-2A	T14-50 FR
91343-3	T42-100 FR
91343-4	T150-300 FR
91343-5	T-400 FR
91343-5678	T3-100 FR
91343-6	T500-600 FR
91343-910	T150-400 FR
91344-1	F3-9 FR
91344-1213	F3-23 FR
91344-1415	F42-100 FR
91344-1617	F75-200 FR
91344-2	F-23 FR
91344-3	F42-60 FR
91344-4	F75-100 FR
91344-5	F133-200 FR
91344-6	F150-400 FR
91346-3	6S100-200 FR
91346-30	202A111-3-0
91346-31	202A111-3/42-0
91346-32	202A111-3/86-0
91347-30	202A121-3-0
91347-31	202A121-3/42-0
91347-32	202A121-3/86-0
91348-1	8S23-75 FR
91348-2	8S14-50 FR
91348-3	8S42-100 FR
91348-30	202A132-3-0
91348-31	202A132-3/42-0
91348-32	202A132-3/86-0
91349-30	202A142-3-0
91349-31	202A142-3/42-0
91349-32	202A142-3/86-0
91350-30	202A153-3-0
91350-31	202A153-3/42-0
91350-32	202A153-3/86-0
91351-30	202A163-3-0

Ordering Information (Continued)

Description XL Part No.	Convert to Description
91351-31	202A163-3/42-0
91351-32	202A163-3/86-0
91352-30	202A174-3-0
91352-31	202A174-3/42-0
91352-32	202A174-3/86-0
91353-30	202A185-3-0
91353-31	202A185-3/42-0
91353-32	202A185-3/86-0
91354-30	202A196-3-0
91354-31	202A196-3/42-0
91354-32	202A196-3/86-0
913L87-30	202D921-3/-0
913L87-31	202D921-3/42-0
913L87-32	202D921-3/86-0
91387-30	202A921-3/-0
91387-31	202A921-3/42-0
913L47-30	202D121-3/-0
913L47-31	202D121-3/42-0
913L47-32	202D121-3/86-0
913L48-30	202D132-3/-0
913L48-31	202D132-3/42-0
913L48-32	202D132-3/86-0
913L49-30	202D142-3/-0
913L49-31	202D142-3/42-0
913L49-32	202D142-3/86-0
913L50-30	202D153-3-0
913L50-31	202D153-3/42-0
913L50-32	202D153-3/86-0
913L51-30	202D163-3-0
913L51-31	202D163-3/42-0
913L51-32	202D163-3/86-0
913L52-30	202D174-3-0
913L52-31	202D174-3/42-0
913L52-32	202D174-3/86-0
913L53-30	202D185-3-0
913L53-31	202D185-3/42-0
913L53-32	202D185-3/86-0
913L54-31	202D196-3/42-0
913L54-32	202D196-3/86-0
913L66-30	202D211-3-0
913L66-31	202D211-3/42-0
913L66-32	202D211-3/86-0
913L67-30	202D221-3-0
913L67-31	202D221-3/42-0
913L67-32	202D221-3/86-0
913L68-30	202D232-3-0
913L68-31	202D232-3/42-0
913L68-32	202D232-3/86-0
913L69-30	202D242-3-0
913L69-31	202D242-3/42-0
913L69-32	202D242-3/86-0
913L70-30	202D253-3-0
913L70-31	202D253-3/42-0

Description XL Part No.	Convert to Description
913L70-32	202D253-3/86-0
913L87-30	202D921-3-0
913L87-31	202D921-3/42-0
913L87-32	202D921-3/86-0
913R48-30	222A132-3-0
913R48-31	222A132-3/42-0
913R48-32	222A132-3/86-0
913R49-30	222A142-3-0
913R49-31	222A142-3/42-0
913R49-32	222A142-3/86-0
913R50-30	222A152-3-0
913R50-31	222A152-3/42-0
913R50-32	222A152-3/86-0
913R51-30	222A163-3-0
913R51-31	222A163-3/42-0
913R51-32	222A163-3/86-0
913R52-30	222A174-3-0
913R52-31	222A174-3/42-0
913R52-32	222A174-3/86-0
913RL48-30	222D132-3-0
913RL48-31	222D132-3/42-0
913RL48-32	222D132-3/86-0
913RL49-30	222D142-3-0
913RL49-31	222D142-3/42-0
913RL49-32	222D142-3/86-0
913RL50-30	222D152-3-0
913RL50-31	222D152-3/42-0
913RL50-32	222D152-3/86-0
913RL51-30	222D163-3-0
913RL51-31	222D163-3/42-0
913RL51-32	222D163-3/86-0
913RL52-30	222D174-3-0
913RL52-31	222D174-3/42-0
913RL52-32	222D174-3/86-0
913Y95-30	381A301-71/-0
913Y95-31	381A301-71/42-0
913Y95-32	381A301-71/86-0
913Y96-30	381A302-71/-0
913Y96-31	381A302-71/42-0
913Y96-32	381A302-71/86-0
HHW-1.3/6A	SST-6-13FR/97-0
HHW-13/6A	SST-6-13FR/97-0
HHW-15/12	SST-12-15FR/97-0
HHW-15/6	SST-6-15FR/97-0
HHW-15/9	SST-9-15FR/97-0
HHW-20/9	SST-9-20FR/97-0
HRSR-1	URHR-1
HRSR-2	URHR-2
HRSR-3	URHR-3
HRSR-4	URHR-4
HRSR-5	URHR-5
XHTA	RHW
XHTU	RHW
XMTA	RPRD

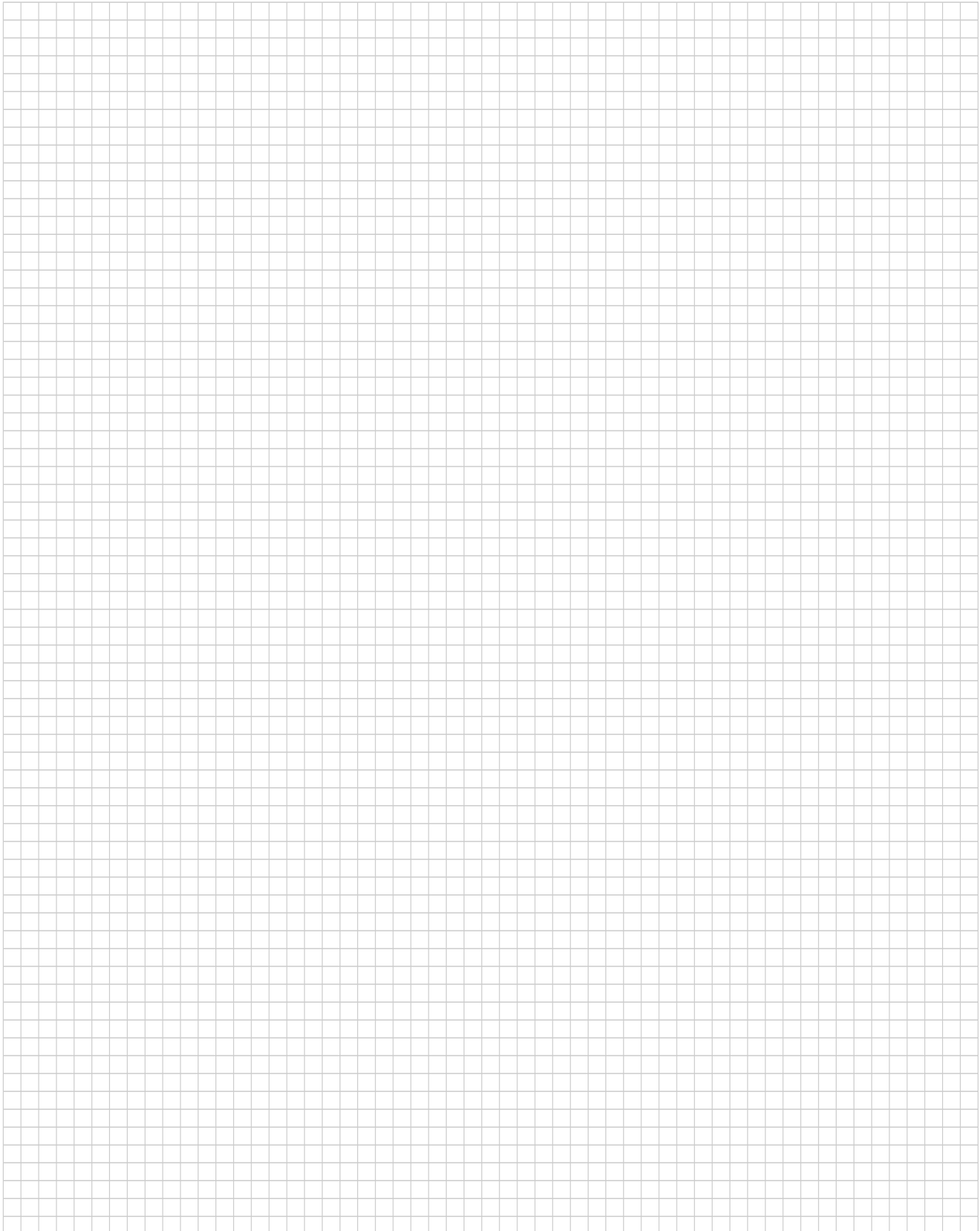

Tyco Electronics manufactures Raychem adhesives and sealants to accommodate a wide range of applications, materials, and environmental conditions.

Raychem adhesives include both thermosets and thermoplastics.

Thermosets are curable two-part epoxies or crosslinked elastomers.

Thermoplastics are hot-melt adhesives that flow when heated and set when cooled. They reflow when reheated to simplify component repair.

Tyco Electronics also manufactures Raychem products that include a thermoplastic adhesive or a mastic-type sealant for water holdout applications. The sealants adhere to non-oily substrates and can be removed where reentry is necessary.

Table of Contents

Selection Guide 5-1
 Adhesive/Sealant Product Characteristics Table 5-2, 5-3
 Adhesive/Sealant Selection Table 5-4
Installation Guide 5-5 to 5-7

Selection Guide



To determine the adhesive or sealant most compatible with a Raychem part, you must know the part's product type.

Use the Adhesive/Sealant Selection Table on page 5-4 to determine a Raychem part's product type and the adhesive/sealant compatible with that type.

Use the Adhesive/Sealant Product Characteristics Table (pages 5-2 and 5-3) to be sure the adhesive or sealant has the product characteristics your application requires.

To use the Selection Table, follow these four steps:

1. Under "Substrate Category," find the product material and product name/part number for the Raychem part.
2. Across the top of the table, find the part's product type and dash number.
3. At the intersection of the substrate category (product material/name/part number) and the product type (by designated dash number) you will find the part number for the most compatible adhesive for the Raychem part.

4. See the Adhesive/Sealant Product Characteristics Table to verify the characteristics of the adhesive/sealant you selected.

Note: Users should independently evaluate the suitability of the product for their application. Before ordering, check with Tyco Electronics for most current data.

Product Type	Precoat Designation	Type	Operating Temperature Range	Product Designation	Available Form/Packaging
Thermosets					
S-1006	—	Epoxy/polyamide two-part paste	-55°C to 135°C [-67°F to 275°F]	S-1009 Kit 8	50-ml dual syringe
				S-1006 Kit A	Ten 3-gram packs
S-1009	—	Epoxy/polymercaptan two-part paste	-55°C to 135°C [-67°F to 275°F]	S-1009 Kit A	Ten 3-gram packs
				S-1009 Kit 8	50-ml dual syringe
S-1255-04	—	One-part epoxy tape adhesive	-55°C to 200°C [-67°F to 392°F]	S-1255-04	Tape [3/4 in. x .020 x 100 ft.]
S-1125	—	Epoxy/polyamide two-part paste	-55°C to 150°C [-67°F to 302°F]	S-1125 Kit 1	Five 10-gram packs
				S-1125 Kit 2	Two 10-gram packs
				S-1125 Kit 3	One 100-gram pack
				S-1125 Kit 4	Five 10-gram packs
				S-1125 Kit 5	One 10-gram pack
				S-1125 Kit 8	50-ml dual syringe
	/225	Precoated latent-curing epoxy/polyamide	-75°C to 150°C [-103°F to 302°F]	Precoat only on -25 molded parts	—
Thermoplastics					
S-1017	/42	Hot-melt/polyamide	-20°C to 60°C*** [-4°F to 140°F]	S-1017	Tape [1 in. x .010 in. x 50 ft.]
S-1030	/180	Hot-melt/polyolefin	-80°C to 80°C [-112°F to 176°F]	S-1030	Tape [3/4 in. x .010 in. x 33 ft.]
S-1048	/86	Hot-melt, high performance	-55°C to 120°C [-67°F to 248°F]	S-1048	Tape [1 in. x .026 in. x 100 ft.]
S-1124	/164	Hot-melt/elastomeric polymer	-55°C to 105°C [-67°F to 221°F]	S-1124	Tape [3/4 in. x .018 in. x 10 ft.]
S-1297	/97	Hot-melt/polyamide adhesive	-20°C to 90°C [-4°F to 194°F]	S-1297	Tape [1 in. x .010 in. x 10 ft.]
Sealants					
S-1278	—	Hot-melt grey butyl sealant	-40°C to 90°C [-40°F to 194°F]	S-1278-01	Tape [1 in. x .062 in. x 25 ft.]
				S-1278-02	Tape [33/4 in. x .125 in. x 10 ft.]
S-1305	—	Hot-melt grey butyl sealant	-40°C to 90°C [-40°F to 194°F]	S-1305-01	Tape [1 in. x .062 in. x 25 ft.]

*Shelf life from date of manufacture.
 **For specific adhesion properties, see product specification sheets.
 ***Passes cold bend at -40°C [-40°F] per RT-4204.
 ****Only S-1006 Kit A conforms to MIL-A-46864.

Pot Life at 23°C [73.4°F]	Curing Conditions	Shelf life* at or below 25°C [77°F]	Specifications**	Comments
1 h	96 h at 20°C [68°F] min. or 1 hr at 120°C [248°F]	2 years 1 year Kit 8	RT-1006 RK-6612 MIL-A-46864****	General purpose harnessing adhesive. Not used on Viton® fluoroelastomers, silicone or Kynar®; 20-minute pot life
20 min.	24 h at 20°C [68°F] min. or 1 hr at 95°C [203°F]	2 years 1 year Kit 8	RT-1009	General purpose harnessing adhesive. Not used on Viton® fluoroelastomers or silicone; 20-minute pot life
	45 min at 120°C [248°F] 2 h at 155°C [311°F] min. or 15 min at 240°C [464°F]	1 year	RT-1014	One-part epoxy tape used with Viton® fluoroelastomer harness systems. Heat cure required (2 hours at 155°C [311°F])
90 min.	24 h at 20°C min. or 1 hr at 85°C [185°F]	18 months 1 year Kit 8	RT-1011 RK-6619 VG-95343	Good fluid-resistant epoxy used with System 25
	Cure during installation of molded parts	36 months	VG-95343 RK-6630	Precoated epoxy system for System 25
—	120°C [248°F]	Unlimited	RT-1050/1	General purpose harnessing adhesive. Standard precoated adhesive for -3 and -4 molded parts
—	120°C [248°F]	Unlimited	RT-1050/6 RK-6017	Good low-temperature flexibility. Available as a preinstalled tape for molded parts
—	160°C [320°F]	Unlimited	RT-1050/3 RK-6626	Requires high temperature to achieve bonding. Highest service temperature for hot melt
—	135°C [275°F]	Unlimited	RT-1050/13	Requires reflowing in an oven at 150°C [302°F] for 90 minutes. Designed to bond to -51 molded parts.
—	120°C [248°F]	Unlimited	RW-2019	General purpose harnessing adhesive. Standard precoated adhesive in Sigmaform molded parts, CES and CSGA cable entry seals, and SST-FR heat-shrinkable tubing
—	110°C [230°F]	Unlimited	RW-2020	General purpose sealant and cable breakout area filler
—	110°C [230°F]	Unlimited	RW-2021	Halogen-free, flame-retardant sealant and cable breakout area filler

*Shelf life from date of manufacture.

**For specific adhesion properties, see product specification sheets.

***Passes cold bend at -40°C [-40°F] per RT-4204.

****Only S-1006 Kit A conforms to MIL-A-46864.

VITON is a trademark of Dupont Dow Elastomers LLC

Catalog 1654025
Revised 12-04

www.tycoelectronics.com

Dimensions are in millimeters and inches unless otherwise specified. Values in brackets are U.S. equivalents.

Dimensions are shown for reference purposes only. Specifications subject to change.

USA: 1-800-522-6752
Canada: 1-905-470-4425
Mexico: 01-800-733-8926
C. America: 52-55-5-729-0425

South America: 55-11-3611-1514
Japan: 81-44-900-5102
Singapore: 65-4866-151
UK: 44-1793-528171

Adhesive/Sealant Selection Table

Substrate Category	Product Name Examples	Molded Part Material Dash Number												
		-3	-4	-6	-8	-12	-25	-50	-51	-55	-71	-100	-125	-130
Polyolefin	RNF-100	S-1006	S-1006	—	—	—	—	—	—	—	S-1006	—	—	S-1006
	Versafit	S-1009	S-1009	—	—	—	—	—	—	—	S-1009	—	—	S-1009
	CRN	S-1017	S-1017	—	—	—	—	—	—	—	S-1017	—	—	S-1017
	BSTS	S-1030	S-1030	—	—	—	—	—	—	—	S-1030	—	—	—
	SST	S-1048	S-1048	—	—	—	—	—	—	—	S-1048	—	—	—
	HR	S-1297	S-1297	—	—	—	—	—	—	—	S-1297	—	—	—
Fluoro-polymer	Kynar®	S-1009	S-1009	—	S-1009	—	S-1125	—	—	—	S-1009	—	S-1009	—
		S-1048	S-1048	—	—	—	—	—	—	—	S-1048	—	S-1048	—
		S-1125	S-1125	—	—	—	—	—	—	—	S-1125	—	S-1125	—
	RT555	—	—	—	—	S-1255	—	—	—	S-1255	—	—	S-1255	—
	HCTE	—	—	—	—	S-1255	S-1125	—	—	S-1255	—	—	—	—
CONVOLEX	—	—	—	—	S-1125	—	—	—	S-1125	—	—	—	—	
Vinyl	PVC	S-1006	S-1006	—	—	—	—	—	—	—	S-1006	—	—	—
		S-1009	S-1009	—	—	—	—	—	—	—	S-1009	—	—	—
		S-1017	S-1017	—	—	—	—	—	—	—	S-1017	—	—	—
Elastomer	DR-25	—	—	—	—	—	S-1125	S-1125	S-1125	—	—	—	—	—
		S-1006	S-1006	—	—	—	—	—	S-1124	—	S-1006	—	—	—
	NT	S-1009	S-1009	—	—	—	—	—	—	—	S-1009	—	—	—
		S-1017	S-1017	—	—	—	—	—	—	—	S-1017	—	—	—
	NT-FR	—	—	—	—	—	S-1125	—	S-1124	—	—	—	—	—
	SFR	—	—	*	—	—	—	—	—	—	—	—	—	—
	SRFR	—	—	*	—	—	—	—	—	—	—	—	—	—
	Viton®	—	—	—	—	S-1255	—	—	—	S-1255	—	—	S-1255	—
VPB	—	—	—	—	—	—	S-1125	—	—	—	—	—	—	
Zerohal	XFFR	—	—	—	—	—	—	—	—	—	—	S-1030	—	—
	ZHTM	—	—	—	—	—	—	—	—	—	—	S-1030	—	—

*GE RTV 108 used with SFR SRFR and -6 (silicone) molded parts.

VITON is a trademark of Dupont Dow Elastomers LLC

Installation Guide

Substrate Preparation Procedures

Preparation of the substrate depends on the part to be bonded. Following are two preparation procedures. The first applies to plated metals and adapters; the second applies to polymer molded parts, cable jackets, and tubing materials.

Plated Metals and Adapters

Thoroughly degrease the surface with a clean cloth or paper wipe dampened with a solvent. The cloth or paper should not be saturated with the solvent.

Allow the part to stand for a minute or two to allow complete evaporation of the solvent.

Molded Parts, Cable Jackets, and Tubing Materials

Carefully and evenly abrade the surface with #320 emery cloth. Wipe contaminants and abraded particles away with a clean cloth or paper wipe dampened with a solvent. The cloth or paper should not be saturated with the solvent. Allow the part to stand for a minute or two to allow complete evaporation of the solvent.

Note:

- Avoid contamination of the prepared surface. If using primer, apply it according to the manufacturer's instructions and allow it to dry.
- Epoxy adhesives may cause skin and eye irritation. Be sure to observe the handling instructions.
- When using hot-melt adhesives on substrates with high heat-sink capacity (such as connector backshells), preheat the substrate until it is hot to touch, then apply the adhesive tape and shrink the molded part in place.

Caution:

The use of cleaning solvent is described in the preparation of various components for adhesive bonding. Please observe the solvent manufacturer's safety recommendations. Several Raychem epoxy adhesives and solvent base primers are also described in some cases. For specific handling precautions, please consult the appropriate Raychem material safety data sheet for the adhesive being used.

Installation Procedures

The three sets of installation instructions that follow are based on the type and/or form of adhesive or sealant to be used.

Select the set of instructions that applies to your application.

Tape Adhesives and Sealants Connector Boot

1. Degrease the area of the adapter to which the boot will be bonded, using appropriate solvent on a paper tissue or clean cloth. Do not abrade the adapter.
2. Lightly abrade the bonding area of the cable jacket with #320 emery cloth, then wipe off loose particles with a tissue or clean cloth dampened with a solvent.
3. Lightly abrade and wipe 25.4 [1.0] back inside each end of the boot.
4. When using primer, apply a thin, uniform coating to the bonding surface and let it air dry (15–20 minutes).
5. Double-wrap the adhesive tape around the cleaned area of the adapter, placing slight tension on the tape as you wrap. Tack the ends in place with a soldering iron or hot tool.

6. Double-wrap adhesive tape around the cable jacket where the end of the boot is to be located.
7. Position the boot on the adapter and the cable. Apply heat, starting at the connector end.
8. Recover the connector end of the boot onto the adapter and continue heating until the area is fully recovered and the adhesive tape is properly melted.
9. Complete the recovery of the boot, continuing toward the cable end. Heat the cable end of the boot where the adhesive is placed, until the part is fully recovered and the tape has properly melted or flowed. The tape should appear wet, form a bead or fillet between the cable and boot, and show no definition between the layers of tape.
10. Where oven curing is required to complete adhesive bonding, heat the assembled harness in a preheated oven according to the following schedule:
S-1255-02:
2 hours at 155°C [311°F]
S-1124:
90 minutes at 150°C [302°F]

Transition

1. Lightly abrade the bonding area of the cable jacket with #320 emery cloth, then wipe off loose particles with a tissue or clean cloth dampened with a solvent.
2. Abrade and wipe the inside of each transition opening.
3. When using primer, apply a thin, uniform coating to the bonding surface and let it air dry (15–20 minutes).

Installation Guide (Continued)

4. Double-wrap the tape around the abraded areas of the cable, placing slight tension on the tape as you wrap. Tack the ends in place with a soldering iron or hot tool.
5. Center the molded part over the transition area. When properly positioned, the part should not fit tightly in the "branched" area of the breakout. A tight fit may cause the part to crease or wrinkle as it recovers. The tape should extend slightly beyond the end of the transition.
6. Apply heat to the center of the transition. Recover one leg of the transition, moving heat from the center of the transition to the adhesive opening of the leg. Repeat the procedure on each leg of the transition.
7. Continue heating each end of the transition until the part is fully recovered and the adhesive tape has properly melted or flowed. The tape should now appear wet, form a bead or fillet between the cable and transition, and show no definition between the layers of tape.
8. Where oven curing is required to complete adhesive bonding, heat the assembled harness in a preheated oven according to the following schedule:

S-1255-02:
2 hours at 155°C [311°F]

S-1124:
90 minutes at 150°C [302°F]

Thermosets**Connector Boot**

1. Thoroughly mix the two parts according to the instructions provided with the kit.
2. Degrease the area of the adapter to which the boot will be bonded, using appropriate solvent on a paper tissue or clean cloth. Do not abrade the adapter.
3. Lightly abrade the bonding area of the cable jacket with #320 emery cloth, then wipe off loose particles with a tissue or clean cloth.
4. Lightly abrade back 25.4 mm [1.0] inside each end of the boot.
5. Using a spatula, apply the mixed adhesive to the adapter and shrink the boot to the end of the adapter.
6. Apply adhesive to the cable jacket and complete the shrinking process.
7. With a clean cloth, remove excess adhesive from all areas immediately.
8. Follow the curing conditions outlined in this guide.

Transition

1. Thoroughly mix the two parts according to the instructions provided with the kit.
2. Lightly abrade the bonding area of the cable jacket with #320 emery cloth, then wipe off loose particles with a tissue or clean cloth.
3. Abrade and wipe inside each opening of the transition.
4. Using a spatula, apply the mixed adhesive to the cable jacket.
5. Apply heat to the center of the transition. Recover one leg of the transition, moving heat from the center of the transition to the adhesive opening of the leg. Repeat the procedure on each leg.
6. Remove excess adhesive from all areas immediately with a clean cloth.
7. Follow the curing conditions specified for "thermosets" in the "Adhesive/Sealant Product Characteristics Table" on pages 5-2 and 5-3.

Installation Guide (Continued)**Molded Parts Pre-coated
with Thermoplastic
Adhesive****Connector Boot**

1. Degrease the area of the adapter to which the boot will be bonded, using appropriate solvent on a paper tissue or clean cloth. Do not abrade the adapter or inside surface of the boot.
2. Lightly abrade the bonding area of the cable jacket with #320 emery cloth, then wipe off loose particles with a tissue or clean cloth dampened with solvent.
3. Position the boot on the adapter and cable. Apply heat starting at the connector end.
4. Recover the connector end of the boot onto the adapter and continue heating until the area is fully recovered and the adhesive is properly melted.
5. Complete the recovery of the boot, continuing toward the cable end of the boot until the part is fully recovered and the adhesive is properly melted. The adhesive should form a bead or fillet between the cable and boot when fully melted.
6. With a clean cloth, remove excess adhesive from all areas immediately.
7. Follow the curing conditions outlined in this guide.

Transition

1. Lightly abrade the bonding area of the cable jacket with #320 emery cloth, then wipe off loose particles with a tissue or clean cloth dampened with solvent.
2. Center the molded part over the transition area.
3. Apply heat to the center of the transition. Recover one leg of the transition, moving heat from the center of the transition to the adhesive opening of the leg. Repeat the procedure on each leg of the transition.
4. Continue heating each end until the part is fully recovered and the adhesive has properly melted. The adhesive should form a bead or fillet between the cable and transition when fully melted.
5. Follow the curing conditions specified for "thermosets" in the "Adhesive/Sealant Product Characteristics Table" on pages 5-2 and 5-3.

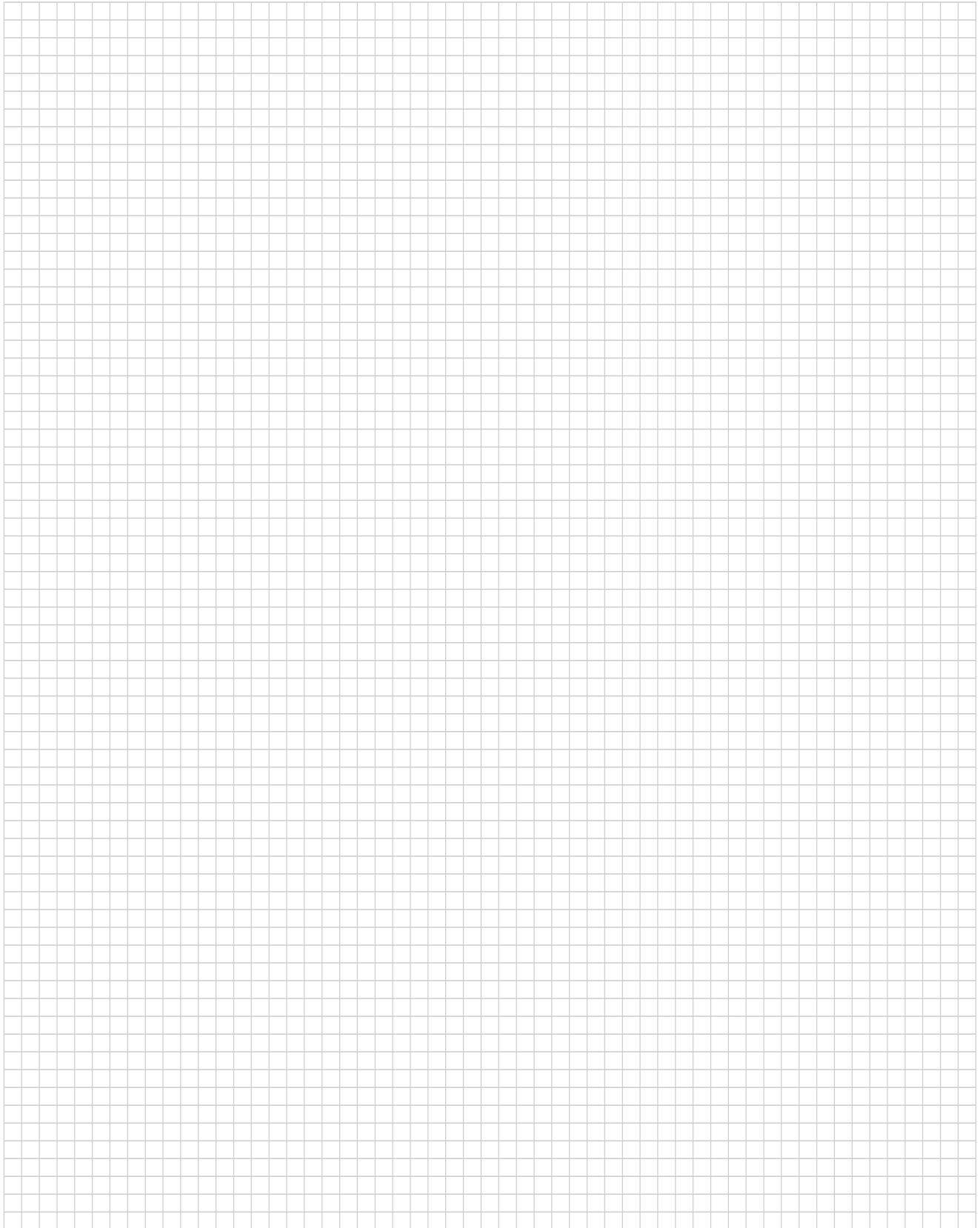

For high-performance sealing and strain relief, the perfect mate for a Raychem molded part in a wiring application is a Raychem adapter.

Tyco Electronics offers a variety of Raychem adapters for applications in many industries, including aerospace, marine, and mass transit.

These adapters are:

- Available in many configurations to match applications
- Easy to install
- Ideal for high-reliability applications
- Kitted for customer convenience.

In this section we present Raychem spin-coupling adapters and Tinel-Lock adapters.

The Tinel-Lock adapter utilizes Raychem's Tinel ring to terminate the overall shield to the adapter. The Tinel ring is a low-profile, high-strength, shape-memory-alloy shield-termination device available in many sizes to accommodate various entry sizes and shield configurations.

Tinel-Lock adapters are ideal for lightweight aerospace applications requiring repeated high-to-low temperature cycles.

Note: Users should independently evaluate the suitability of the product for their application. Before ordering, check with Tyco Electronics for most current data.

Table of Contents

Adapter Fundamentals

Definitions 6-2
 Types of Adapters 6-3, 6-4
 Adapter Selection Process 6-5

Adapter Selection

Raychem Adapter Code 6-6 to 6-15
 Raychem Adapter Family 6-16
 Raychem Part Number 6-17, 6-18
 Material and Finish 6-19
 Entry Size 6-20 to 6-25
 Tinel-Lock Ring 6-26
 CRES-Lock Bands/BND Adapters 6-27

Adapter Products

Code 18 MIL-C-5015 (MS3100)

Braided Adapters 6-28, 6-29
 Solid Adapters 6-30, 6-31
 Spin-Coupling Adapters 6-32, 6-33
 Tinel-Lock Adapters 6-34 to 6-36

Code 21 MIL-C-26482 Series 1

Braided Adapters 6-37
 Solid Adapters 6-38
 Spin-Coupling Adapters 6-39
 Tinel-Lock Adapters 6-40, 6-41
 CRES-Lock Adapters/BND Adapters 6-42, 6-43

Code 32 MIL-C-22992

Braided Adapters 6-44, 6-45
 Spin-Coupling Adapters 6-46
 Tinel-Lock Adapters 6-47
 CRES-Lock Adapters/BND Adapters 6-48, 6-49

Code 40 MIL-C-38999 Series III and IV

Braided Adapters 6-50, 6-51
 Solid Adapters 6-52
 Spin-Coupling Adapters 6-53
 Tinel-Lock Adapters 6-54, 6-55
 CRES-Lock Adapters/BND Adapters 6-56, 6-57

Code 41 MIL-C-38999 Series I and II

Braided Adapters 6-58, 6-59
 Solid Adapters 6-60
 Spin-Coupling Adapters 6-61
 Tinel-Lock Adapters 6-62, 6-63
 CRES-Lock Adapters/BND Adapters 6-64, 6-65

Code 54 MIL-C-5015 (MS3400), MIL-C-26482 Series 2,

MIL-C-83723 Series I and III, MIL C-81703 Series III

Braided Adapters 6-66, 6-67
 Solid Adapters 6-68
 Spin-Coupling Adapters 6-69
 Tinel-Lock Adapters 6-70, 6-71
 CRES-Lock Adapters/BND Adapters 6-72, 6-73

Code 76 BS 9522 F0017 (Pattern 105)

Spin-Coupling Adapters 6-74
 Tinel-Lock Adapters 6-75, 6-76

Introduction

For high-performance sealing and strain relief, the perfect mate for a Raychem molded part in a wiring application is a Raychem adapter.

Tyco Electronics offers a variety of Raychem adapters for applications in many industries, including aerospace, marine, and mass transit.

These adapters are:

- Available in many configurations to match applications
- Easy to install
- Ideal for high-reliability applications
- Kitted for customer convenience.

In this section we present Raychem spin-coupling adapters and Tinel-Lock adapters.

The Tinel-Lock adapter utilizes Raychem's Tinel ring to terminate the overall shield to the adapter. The Tinel ring is a low-profile, high-strength, shape-memory-alloy shield-termination device available in many sizes to accommodate various entry sizes and shield configurations.

Tinel-Lock adapters are ideal for lightweight aerospace applications requiring repeated high-to-low temperature cycles.

Definitions

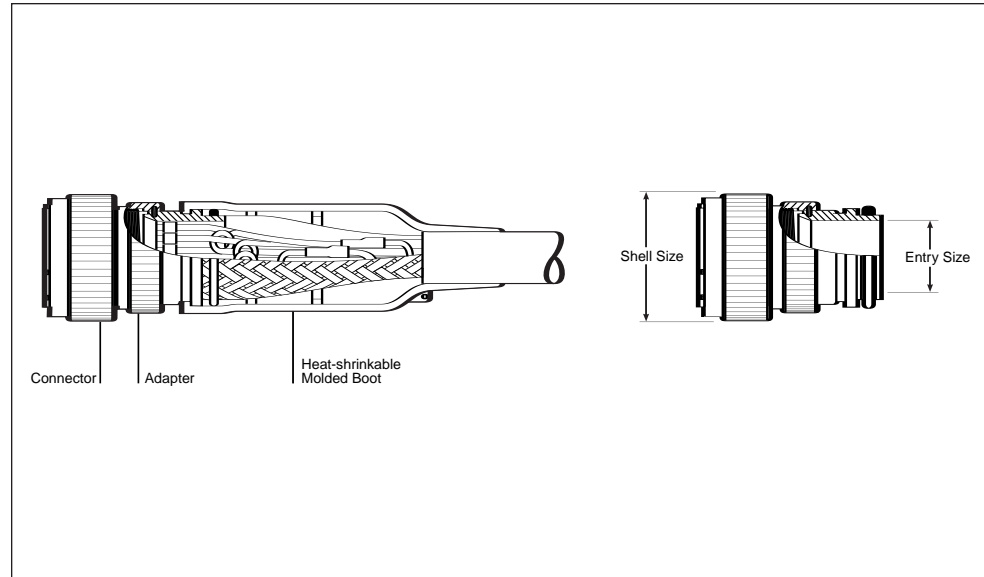

Adapter Type

Tyco Electronics offers four Raychem adapter types: solid (sometimes called "fixed"), spin-coupling, braided, and Tinel-Lock. Each is designed to offer a suitable interface between a connector and a heat-shrinkable molded part.

Raychem Adapter Code

A numerical code is used to identify connectors with similar adapter interfaces. This code is used to determine the adapter family and part number.

Adapter Part Number

The part number is the sequence of numbers and letters that describes the adapter family (or series), size, material, finish, and modifications. The part numbering system is explained on pages 6-17 and 6-18.

Adapter Family

Tyco Electronics offers several families (or series) of Raychem adapter products. Each Raychem adapter part number begins with an alphanumeric prefix denoting the Raychem product family.

Entry Size

Entry size is the diameter of the hole through which the cable enters into the adapter. For example, the 08 entry is 12.7 [0.5]. Entry sizes are specified on braided and Tinel-Lock adapters only.

Ring Designator

This is a two-letter code that is part of each Tinel-Lock adapter part number. It specifies the size of the Tinel-Lock ring suited to specific types of cable braid.

Shell Size

This is the size of a connector as specified by the connector manufacturer. It is normally a two-digit number between 08 and 24, although certain connectors are obtainable in either larger or smaller sizes and some use letter codes.

Order Number

This is a two-digit number that specifies the size of the adapter that will mate to the corresponding shell size of a connector. The order number is frequently the same as the connector shell size, but should be checked by reference to the appropriate product page(s) in this catalog.

Types of Adapters

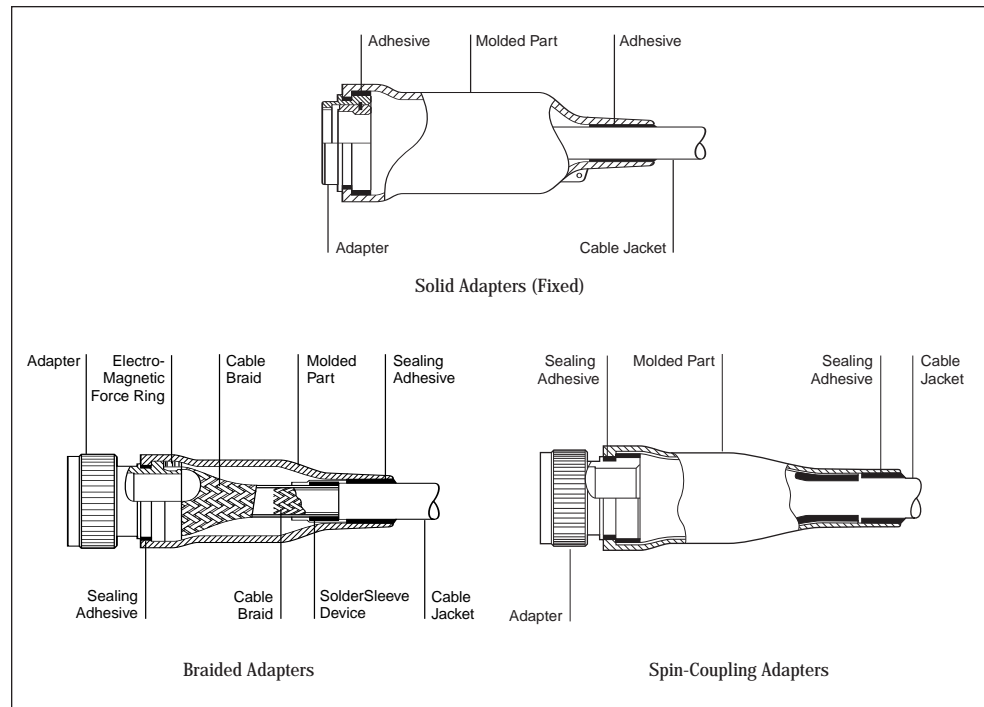

Adapter Types

Tyco Electronics offers several types of Raychem adapters for unscreened and screened termination systems. The choice is largely dependent upon the screening level required and the braid termination method.

The four principal adapter types are:

- Solid (fixed)
- Spin-Coupling
- Braided
- Tinel-Lock

Solid Adapters (Fixed)

Solid adapters are designed for use where no access is required; for example, when potting is necessary or a lower space profile is needed.

These adapters have a boot groove to accommodate a lipped heat-shrinkable boot. Repair cannot be made without removing the boot.

Spin-Coupling Adapters

Spin-coupling adapters are two-part components that have a rotatable coupling nut and a grooved body designed to accommodate lipped-type heat-shrinkable boots.

Spin-couplings with an appropriate molded part are used for environmental protection and strain relief of unscreened cable terminations. Cable repairs can be made without damaging the boot.

Braided Adapters

These are spin-coupling adapters that have a short length of tubular braided shield attached to the rear of the adapter. The braid is constructed from tinned copper wire and has a handling characteristic that enables it to be pulled down onto a wide range of cable diameters. This allows a standard entry size to be used with most cable sizes.

The shield is terminated to the cable braid using a Solder Sleeve device, which provides screen continuity through to the connector. Straight, 45°, and 90° configurations are available.

Types of Adapters (Continued)

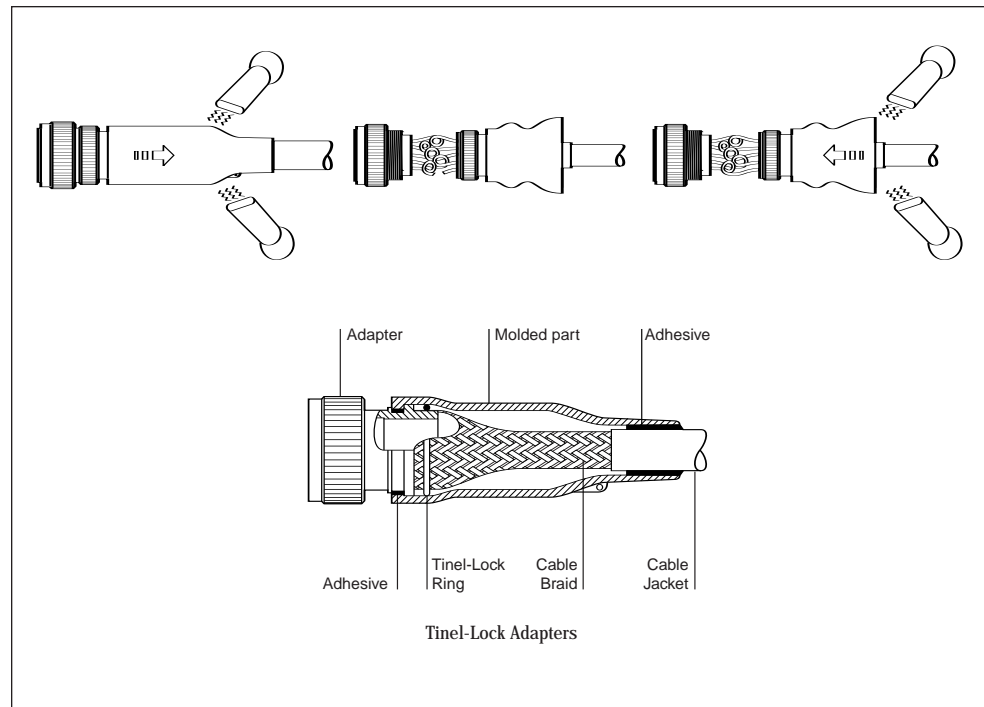

Tinel-Lock Adapters

This termination system consists of a modified spin-coupling adapter with a Tinel-Lock ring. The Tinel-Lock ring is made from a special shape memory metal that shrinks uniformly when heated (see Application Tooling, section 10).

The Tinel-Lock ring is used to terminate copper cable braid directly onto the rear of the adapter. The adapter entry size and ring designator must be selected to suit the cable diameter and braid type.

The resulting 360° termination withstands severe shock, vibration, temperature cycling, and corrosion. Straight, 45°, and 90° configurations are available.

Roll-back Repair with Adapters

More than 85 percent of cable repairs are made within 75 [3.0] of the connectors—usually because of a broken pin or wire. By reheating the heat-shrinkable boot and unscrewing the adapter coupling nut, the boot can be “rolled back,” providing access to the rear of the connector for repair. This technique is applicable to spin-coupling, shielded, and Tinel-Lock adapters.

Step-by-Step Selection Process

Adapter Selection Process

Selecting an adapter for your application involves a five-step process:

1. From the connector number, determine:
 - Order number (shell size)
 - Material
 - Plating
2. Decide what adapter type you need for the connector.
3. Determine the Raychem connector code for that adapter type. (Use Table A, B, or C on pages 6-6 to 6-15).

4. Determine the Raychem adapter family for that connector code. (Use Table D on page 6-16).

5. Build the adapter part number. (See page 6-17).

The chart below will lead you through these steps.

Adapter Selection Flowchart

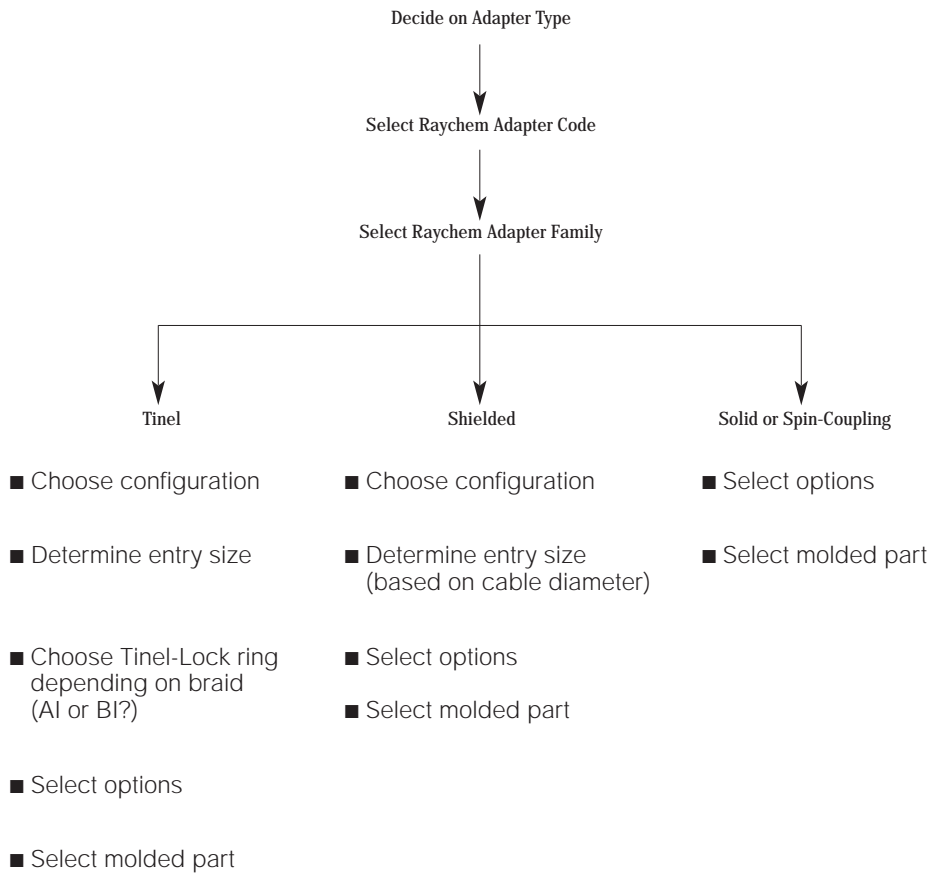

Table A. Raychem Adapter Code by Military Part Number

Selecting the Raychem Adapter Code

Tables A, B, and C that follow provide Raychem adapter codes for typical connectors.

If you know the military part number for the connector, you can obtain the Raychem adapter code from Table A that begins on this page.

If you know the manufacturer's prefix for the connector, you can obtain the Raychem adapter code from Table B that begins on page 6-10.

If you know the connector specification, you can obtain the Raychem adapter code from Table C on page 6-15

Raychem Adapter Code

Military Part No.	Connector Specification	Series/Class	Raychem Adapter Code
D38999/20	MIL-C-38999	Series III: Class C, F, K, W	40
D38999/24	MIL-C-38999	Series III: Class C, F, K, W	40
D38999/26	MIL-C-38999	Series III: Class C, F, K, W	40
D38999/40	MIL-C-38999	Series IV: Class C, F, W	40
D38999/42	MIL-C-38999	Series IV: Class C, F, W	40
D38999/44	MIL-C-38999	Series IV: Class C, F, W	Contact Tyco Electronics
D38999/46	MIL-C-38999	Series IV: Class F, W	40
D38999/47	MIL-C-38999	Series IV: Class C, W	40
M28840/10	MIL-C-28840	Class D, DS	30
M28840/11	MIL-C-28840	Class D, DS	30
M28840/14	MIL-C-28840	Class D, DS	30
M28840/16	MIL-C-28840	Class D, DS	30
M81511/01	MIL-C-81511	Series 2: Class A, E, F	61
M81511/03	MIL-C-81511	Series 2: Class A, E, F	61
M81511/05	MIL-C-81511	Series 2: Class A, E, F	61
M81511/06	MIL-C-81511	Series 2: Class A, E, F	61
M81511/21	MIL-C-81511	Series 1: Class A, E, F	61
M81511/23	MIL-C-81511	Series 1: Class A, E, F	61
M81511/25	MIL-C-81511	Series 1: Class A, E, F	61
M81511/26	MIL-C-81511	Series 1: Class A, E, F	61
M81511/31	MIL-C-81511	Series 2: Class C, P, T	61
M81511/32	MIL-C-81511	Series 2: Class C, P, T	61
M81511/33	MIL-C-81511	Series 2: Class C, P, T	61
M81511/34	MIL-C-81511	Series 2: Class C, P, T	61
M81511/35	MIL-C-81511	Series 1: Class C, P, T	61
M81511/36	MIL-C-81511	Series 1: Class C, P, T	61
M81511/37	MIL-C-81511	Series 1: Class C, P, T	61
M81511/38	MIL-C-81511	Series 1: Class C, P, T	61
M81511/41	MIL-C-81511	Series 3: Class A, E, F	61
M81511/45	MIL-C-81511	Series 3: Class A, E, F	61
M81511/46	MIL-C-81511	Series 3: Class A, E, F	61
M81511/49	MIL-C-81511	Series 3: Class A, E, F	61
M81511/51	MIL-C-81511	Series 4: Class A, E, F	61
M81511/53	MIL-C-81511	Series 4: Class A, E, F	61
M81511/55	MIL-C-81511	Series 4: Class A, E, F	61
M81511/56	MIL-C-81511	Series 4: Class A, E, F	61
M83723/01	MIL-C-83723	Series I: Class A, G, R	54
M83723/02	MIL-C-83723	Series I: Class A, G, R	54
M83723/03	MIL-C-83723	Series I: Class A, G, R	54
M83723/04	MIL-C-83723	Series I: Class A, G, R	54
M83723/05	MIL-C-83723	Series I: Class A, G, R	54
M83723/06	MIL-C-83723	Series I: Class A, G, R	54
M83723/07	MIL-C-83723	Series I: Class A, G, R	54
M83723/08	MIL-C-83723	Series I: Class A, G, R	54
M83723/13	MIL-C-83723	Series I: Class A, G, R	54
M83723/14	MIL-C-83723	Series I: Class A, G, R	54
M83723/17	MIL-C-83723	Series II: Class A, G, R	19
M83723/18	MIL-C-83723	Series II: Class A, G, R	19
M83723/19	MIL-C-83723	Series II: Class A, G, R	19
M83723/20	MIL-C-83723	Series II: Class A, G, R	19
M83723/23	MIL-C-83723	Series II: Class A, G, R	19
M83723/24	MIL-C-83723	Series II: Class A, G, R	19
M83723/36	MIL-C-83723	Series I: Class A, G, R	54
M83723/37	MIL-C-83723	Series I: Class A, G, R	54
M83723/38	MIL-C-83723	Series I: Class A, G, R	54
M83723/39	MIL-C-83723	Series I: Class A, G, R	54
M83723/40	MIL-C-83723	Series I: Class A, G, R	54
M83723/41	MIL-C-83723	Series I: Class A, G, R	54
M83723/42	MIL-C-83723	Series I: Class G, R	54
M83723/43	MIL-C-83723	Series I: Class G, R	54
M83723/48	MIL-C-83723	Series I: Class G, R	54

Table A. Raychem Adapter Code by Military Part Number (Continued)

Raychem Adapter Code (Continued)

Military Part No.	Connector Specification	Series/Class	Raychem Adapter Code
M83723/49	MIL-C-83723	Series I: Class G, R	54
M83723/52	MIL-C-83723	Series II: Class K	19
M83723/53	MIL-C-83723	Series II: Class K	19
M83723/65	MIL-C-83723	Series III: Class H	54
M83723/66	MIL-C-83723	Series III: Class A, G, R	54
M83723/67	MIL-C-83723	Series III: Class A, G, R	54
M83723/68	MIL-C-83723	Series III: Class A, G, R	54
M83723/69	MIL-C-83723	Series III: Class A, G, R	54
M83723/71	MIL-C-83723	Series III: Class A, G, R	54
M83723/72	MIL-C-83723	Series III: Class A, G, R	54
M83723/73	MIL-C-83723	Series III: Class A, G, R	54
M83723/74	MIL-C-83723	Series III: Class A, G, R	54
M83723/75	MIL-C-83723	Series III: Class A, G, R	54
M83723/76	MIL-C-83723	Series III: Class A, G, R	54
M83723/77	MIL-C-83723	Series III: Class G, R	54
M83723/78	MIL-C-83723	Series III: Class G, R	54
M83723/82	MIL-C-83723	Series III: Class A, G, K, R, S	54
M83723/83	MIL-C-83723	Series III: Class A, G, K, R, S	54
M83723/84	MIL-C-83723	Series III: Class A, G, K, R, S	54
M83723/85	MIL-C-83723	Series III: Class A, G, K, R, S	54
M83723/86	MIL-C-83723	Series III: Class A, G, K, R	54
M83723/87	MIL-C-83723	Series III: Class A, G, K, R	54
M83723/91	MIL-C-83723	Series III: Class G, R, W	54
M83723/92	MIL-C-83723	Series III: Class G, R, W	54
M83723/95	MIL-C-83723	Series III: Class A, G, K, R	54
M83723/96	MIL-C-83723	Series III: Class A, G, K, R	54
M83723/97	MIL-C-83723	Series III: Class S	54
M83723/98	MIL-C-83723	Series III: Class S	54
MS17343	MIL-C-22992	Class C, J, R	32
MS17344	MIL-C-22992	Class C, J, R	32
MS17345	MIL-C-22992	Class C, J, R	32
MS17346	MIL-C-22992	Class C, R	32
MS17347	MIL-C-22992	Class C, J, R	32
MS17348	MIL-C-22992	Class C, R	32
MS24264	MIL-C-26500 (AL)	Class F, G, R Type B&T aluminum shell	51
MS24264	MIL-C-26500 (SST)	Class E Type B&T stainless steel shell	52
MS24265	MIL-C-26500 (AL)	Class F, G, R Type B&T aluminum shell	51
MS24265	MIL-C-26500 (SST)	Class E Type B&T stainless steel shell	52
MS24266	MIL-C-26500 (SST)	Class E Type B&T stainless steel shell	52
MS24266	MIL-C-26500 (AL)	Class F, G, R Type B&T aluminum shell	51
MS27466	MIL-C-38999	Series I: Class E, P, T	41
MS27467	MIL-C-38999	Series I: Class E, P, T	41
MS27468	MIL-C-38999	Series I: Class E, P, T	41
MS27469	MIL-C-38999	Series I: Class Y	Contact Tyco Electronics
MS27472	MIL-C-38999	Series II: Class T	41
MS27473	MIL-C-38999	Series II: Class E, P, T	41
MS27474	MIL-C-38999	Series II: Class T	41
MS27475	MIL-C-38999	Series II: Class Y	Contact Tyco Electronics
MS27479	MIL-C-38999	Series II: Class T	41
MS27480	MIL-C-38999	Series II: Class E, T	41
MS27481	MIL-C-38999	Series II: Class T	41
MS27482	MIL-C-38999	Series II: Class Y	Contact Tyco Electronics
MS27484	MIL-C-38999	Series II: Class E, T	41
MS27497	MIL-C-38999	Series II: Class T	41
MS27515	MIL-C-38999	Series I: Class E	Contact Tyco Electronics

Table A. Raychem Adapter Code by Military Part Number (Continued)

Raychem Adapter Code (Continued)

Military Part No.	Connector Specification	Series/Class	Raychem Adapter Code
MS27613	MIL-C-26500 (SST)	Class K Type B&T stainless steel shell	52
MS27614	MIL-C-26500 (SST)	Class K Type B&T stainless steel shell	52
MS27615	MIL-C-26500 (SST)	Class K Type B&T stainless steel shell	52
MS27652	MIL-C-38999	Series I: Class E, T	41
MS27653	MIL-C-38999	Series I: Class E, T	41
MS27654	MIL-C-38999	Series I: Class E, T	Contact Tyco Electronics
MS27656	MIL-C-38999	Series I: Class E, T	41
MS27661	MIL-C-38999	Series I	41
MS27665	MIL-C-38999	Series I	41
MS3100	MIL-C-5015	Class A, E, F, R less endbell; solder contact	18
MS3101	MIL-C-5015	Class A, E, F, R less endbell; solder contact	18
MS3106	MIL-C-5015	Class A, E, F, R less endbell; solder contact	18
MS3107	MIL-C-5015	Class A, E, F, R less endbell; solder contact	18
MS3108	MIL-C-5015	Solder contact with endbell	15
MS3110	MIL-C-26482	Series 1: Class E, F, J, P	21
MS3111	MIL-C-26482	Series 1: Class E, F, J, P	21
MS3114	MIL-C-26482	Series 1: Class E, F, P	24'
MS3116	MIL-C-26482	Series 1: Class E, F, J, P	21
MS3120	MIL-C-26482	Series 1: Class E, F, J, P	21
MS3121	MIL-C-26482	Series 1: Class E, F, J, P	21
MS3124	MIL-C-26482	Series 1: Class E, F, P	24'
MS3126	MIL-C-26482	Series 1: Class E, F, J, P	21
MS3128	MIL-C-26482	Series 1: Class E, F, J, P	21
MS3130	MIL-C-81703	Series 1: Class E, P, J	71
MS3132	MIL-C-81703	Series 1: Class E	71
MS3134	MIL-C-81703	Series 1: Class E, P, J	71
MS3137	MIL-C-81703	Series 1: Class E, P, J	71
MS3138	MIL-C-81703	Series 1: Class E, P, J	71
MS3140	MIL-C-81703	Series 1: Class E, J	71
MS3144	MIL-C-81703	Series 1: Class E, J	71
MS3147	MIL-C-81703	Series 1: Class E, J	71
MS3148	MIL-C-81703	Series 1: Class E, J	71
MS3400	MIL-C-5015	Class D, L, U, W crimp contact	54
MS3401	MIL-C-5015	Class D, L, U, W crimp contact	54
MS3404	MIL-C-5015	Class D, L, U, W crimp contact	54
MS3406	MIL-C-5015	Class D, L, U, W crimp contact	54
MS3408	MIL-C-5015	Class D, L, U, W crimp contact	54
MS3409	MIL-C-5015	Crimp contact	54
MS3412	MIL-C-5015	Class D, L, U, W crimp contact less endbell	54
MS3424	MIL-C-81703	Series 3: Class E, L	54
MS3445	MIL-C-81703	Series 2: Class E	71
MS3446	MIL-C-81703	Series 3: Class E, L	54
MS3450	MIL-C-5015	Class D, L, U, W crimp contact	54
MS3451	MIL-C-5015	Class D, L, U, W crimp contact	54
MS3454	MIL-C-5015	Class D, L, U, W crimp contact	54
MS3456	MIL-C-5015	Class D, L, U, W crimp contact	54
MS3459	MIL-C-5015	Class L, W crimp contact	54
MS3464	MIL-C-81703	Series 3: Class E, L	54
MS3467	MIL-C-81703	Series 3: Class E, L	54
MS3468	MIL-C-81703	Series 3: Class E, L	54
MS3470	MIL-C-26482	Series 2: Class A, L	54
MS3471	MIL-C-26482	Series 2: Class A, L	54
MS3472	MIL-C-26482	Series 2: Class A, L	54
MS3474	MIL-C-26482	Series 2: Class A, L	54
MS3475	MIL-C-26482	Series 2: Class A, L	54
MS3476	MIL-C-26482	Series 2: Class A, L	54
NAS1599	MIL-C-81703	Series 3:	54
NAS1641	MIL-C-81703	Series 3:	54
NAS1642	MIL-C-81703	Series 3:	54
NAS1643	MIL-C-81703	Series 3:	54

¹Code 24 connectors have an internal accessory thread.

Table A. Raychem Adapter Code by Military Part Number (Continued)

Raychem Adapter Code (Continued)

Military Part No.	Connector Specification	Series/Class	Raychem Adapter Code
NAS1650	MIL-C-81703	Series 3:	54
NAS1651	MIL-C-81703	Series 3:	54
NAS1652	MIL-C-81703	Series 3:	54
NAS1653	MIL-C-81703	Series 3:	54
NAS1692	MIL-C-81703	Series 3:	54
NAS1693	MIL-C-81703	Series 3:	54
NAS1694	MIL-C-81703	Series 3:	54
NAS1699	MIL-C-81703	Series 3:	54
NAS1700	MIL-C-81703	Series 3:	54
NAS1701	MIL-C-81703	Series 3:	54
NAS1702	MIL-C-81703	Series 3:	54

Table B. Raychem Adapter Code by Manufacturer's Prefix

Raychem Adapter Code (Continued)

Manufacturer's Prefix	Manufacturer ⁶	Connector Specification	Series/Class	Raychem Adapter Code
10-214	Bendix	MIL-C-5015	MS3100 Class A, E, R	18
10-475	Bendix	40M38277	—	41
10-720	Bendix	MIL-C-5015	MS3100 Class A, E, R	18
118	Amphenol	MIL-C-26482	Series 2	54
149	Deutsch	MIL-C-81703	Series 1	71
162GB	Amphenol	MIL-C-26482	Series 1	76, 77 ⁴
164GB	Amphenol	BS9522 F0023	—	Contact Tyco Electronics
165	Amphenol	None	—	Contact Tyco Electronics
172	Amphenol	MIL-C-5015	—	Contact Tyco Electronics
179	Amphenol	MIL-C-5015	—	Contact Tyco Electronics
182	Amphenol	None	—	Contact Tyco Electronics
246	Amphenol	MIL-C-5015	MS3100 Class E, F, R	18
251	Cannon	MIL-C-26482	Series 1	21
2PPN	Plessey	MIL-C-26482	Series 1	21
2PPN-07	Plessey	MIL-C-26482	Series 1	24 ³
2PSN	Plessey	BS9522 F0017	Patt 105	76, 77 ⁴
2PSN-07	Plessey	MIL-C-26482	Series 1	24 ³
348	Amphenol	MIL-C-81511	Series 1 and 2	61
381	Deutsch	40M39569	—	54
418	Amphenol	MIL-C-38999	Series I and II	41
45/PT	Socapex	MIL-C-26482	Series 1	21
450	Deutsch	MIL-C-26482	Series 1	21
451	Socapex	PRL 54125	—	21 or 24 ³
460	Deutsch	MIL-C-26482	Series 1	21
48	Amphenol	MIL-C-26500	Alum Class F, G, R	51
486	Amphenol	MIL-C-26482	Series 2	54
518	Amphenol	MIL-C-83723	Series III	54
5MS	FKI ²	Def. Stan. 59-35	Patt 121A	75
602	Amphenol	Def. Stan. 59-56	Patt 602	54
602GB	Amphenol	Def. Stan. 59-56	Patt 602	54
62AB-14	Amphenol	MIL-C-26482	Series 1	Contact Tyco Electronics
62GB	Amphenol	Def. Stan. 59-35	Patt 105	76, 77 ⁴
650	Schaltbau	VG 95329	—	61
652	Amphenol	LN 29504	—	54
652	UMD	PRL 54125	—	21 or 24 ³
674	Schaltbau	VG 95328	—	Contact Tyco Electronics
675	Schaltbau	VG 95328	—	Contact Tyco Electronics
679	Schaltbau	VG 95329	—	61
69	Amphenol	MIL-C-5015	MS3100 Class E, F, R	18
71	Bendix	MIL-C-5015	MS3100 Class A, E, R	18
711	Amphenol	BS9522 F0042	—	54
801	Amphenol	None	—	54
837	Deutsch	MIL-C-83723	Series III	54
83723	Souriau	MIL-C-83723	Series III	54
83730	Deutsch	MIL-C-83723	Series III	54
845	Souriau	NFL 54120	—	Contact Tyco Electronics
847	Souriau	NFL 54120	—	Contact Tyco Electronics
850	Souriau	MIL-C-26482	Series 1	21
851	Souriau	MIL-C-26482	Series 1	21
8520	Souriau	MIL-C-26482	Series 2	54
8525	Souriau	NAS 1599	—	54
8526	Souriau	PAN 6432-1	—	54
853	Souriau	MIL-C-83723	Series III	54
857	Souriau	LN 29728	—	54
89	Souriau	NFL 54140	—	54

²FKI was previously Thorn.

³Code 24 connectors have an internal accessory thread.

⁴Code 77 braided version.

Table B. Raychem Adapter Code by Manufacturer's Prefix (Continued)

Raychem Adapter Code (Continued)

Manufacturer's Prefix	Manufacturer ⁶	Connector Specification	Series/Class	Raychem Adapter Code
891	Souriau	MIL-C-5015	Class K	Contact Tyco Electronics
892	Souriau	MIL-C-5015	Class K	Contact Tyco Electronics
8LT	Souriau	MIL-C-38999	Series I	41
8ST	Souriau	VG 96912	Series 1	47
8T	Souriau	MIL-C-38999	Series II	41
9-815	Deutsch	MIL-C-81511	Series 3 and 4	61
91-483	Bendix	MIL-C-26482	Series 2	54
944	Matrix	MIL-C-5015	MS3400 Class L, U, W	54
951	Deutsch	LN 29500	—	Contact Tyco Electronics
97	Amphenol	MIL-C-5015	MS3100 Class A	18
981	Matrix	MIL-C-5015	MS3400	54
A815	Deutsch	MIL-C-81511	Series 3	61
AA70	Deutsch	Not known	—	71
AB05	AB Elec	Def. Stan. 59-35	Patt 105	76, 77 ⁴
AB06	AB Elec	Def. Stan. 59-35	Patt 105	76, 77 ⁴
ABB	AB Elec	BS9522 F0032	—	78
ABJ	AB Elec	MIL-C-38999	Series I and II	41
ADS	Deutsch	MIL-C-81703	—	71
AFD	Deutsch	MIL-C-83723	Series I	54
AFD5	Deutsch	MIL-C-26482	Series 2	54
B815	Deutsch	MIL-C-81511	Series 4	61
BE	Pyle	MIL-C-83723	Series III	54
BG	Bendix	MIL-C-26482	Series I	21
BL	G&H Tech	MIL-C-38999	Series IV	40
BL	TRW	MIL-C-38999	Series IV	40
BT	Burndy	MIL-C-26482	Series 1	21
BT	Pyle	MIL-C-83723	Series III	54
BTK	Deutsch	MIL-C-26482	Series 1	21
BY1	Pyle	MIL-C-83723	Series III	54
C48	TRW	MIL-C-26500	Aluminum	51
CA (Bayonet)	Cannon	VG 95234	—	58
CA3101	Cannon	MIL-C-5015	MS3100 class E, F, R	18
CA3101	Cannon	MIL-C-5015	MS3100 Class A	18
CA3101KE	Cannon	MIL-C-5015	Class K	Contact Tyco Electronics
CIR	VEAM	VG 95234	—	64 ^{***} , 66 ^{**} , 78 [*]
CN0930	TRW	MIL-C-83723	Series III	54
CT	Burndy	MIL-C-38999	Series II	41
CT	Plessey	MIL-C-38999	Series II	41
CV-R	Cannon	MIL-C-83723	Series II	19
CV34	Cannon	MIL-C-5015	MS3400 Class L, U, W	54
CVA	Cannon	MIL-C-83723	Series II	19
CWL	Cannon	None	—	31
CWLD	Cannon	MIL-C-22992	Class C, J, R	32
D817	Deutsch	MIL-C-81703	Series 3	54
DA	Deutsch	None	—	71
DBAD	Deutsch	MIL-C-81703	—	Contact Tyco Electronics
DBAS	Deutsch	MIL-C-81703	Series 3	54
DD	Deutsch	MIL-C-81703	Series 2	71
DFE	Deutsch	MIL-C-26482	Series 2	54
DKM	Deutsch	VG 95328	—	Contact Tyco Electronics
DL	Deutsch	MIL-C-83723	Series III	54
DM	Deutsch	MIL-C-81703	Series 1	71
DPX	Cannon	—	—	Contact Tyco Electronics
DS	Deutsch	None	—	71
DTS	Deutsch	MIL-C-38999	Series III	40

* AB connectors only
 ** VEAM standard
 *** VEAM panel mount
⁴Code 77 braided version.

Table B. Raychem Adapter Code by Manufacturer's Prefix (Continued)

Raychem Adapter Code (Continued)

Manufacturer's Prefix	Manufacturer ⁶	Connector Specification	Series/Class	Raychem Adapter Code
EA	Pyle	None	—	54
EB	Pyle	NAS 1599	—	54
EEG	Pyle	MIL-C-83723	Series I	54
ES	Pyle	None	—	54
ESC004	Various	MIL-C-5015	Class K	Contact Tyco Electronics
ET	Pyle	NAS 1599	—	54
FC	Flight	MIL-C-5015	Rev E only	Contact Tyco Electronics
FDBA	Deutsch	LN 29504	—	54
FF	Flight	MIL-C-5015	MS3400 Class D, L, U, W	54
FH	Flight	MIL-C-83723	Series III	54
FPK	Pyle	MIL-C-26500	Class K	52
FP5K	Pyle	MIL-C-26500	Class K	Contact Tyco Electronics
FYL	Pyle	MIL-C-26500	Class K	52
G	Burndy	None	—	21
GC-E	General	MIL-C-26482	Series 1	21
GTA	Hughes	MIL-C-28840	—	30
HAN	Deutsch	MIL-C-5015	MS3100 Class E, KE	Contact Tyco Electronics
HD	SAE	MIL-C-28840	—	30
HTMAS	Cannon	MIL-C-5015	Class K	Contact Tyco Electronics
HTMF	Cannon	MIL-C-83723	Series III: Class K	54
HTMS	AB Elec	MVEE 695	—	75
JT	Amphenol	MIL-C-38999	Series II	41
JT	Bendix/FKI	MIL-C-38999	Series II	41
JT	Socapex	MIL-C-38999	Series II	41
JT-R	FKI ²	PAN 6433-1	—	41
JT-R	Teldix	PAN 6433-1	—	41
KFS	Cannon	MIL-C-28840	—	30
KJ	Cannon	MIL-C-38999	Series II	41
KJA	Cannon	MIL-C-38999	Series III	40
KJJ	Cannon	MIL-C-38999	Series II	Contact Tyco Electronics
KJL	Cannon	MIL-C-38999	Series I	Contact Tyco Electronics
KJL	Cannon	MIL-C-38999	Series I	41
KPSE	Cannon	MIL-C-26482	Series 1	21
KPT	Cannon	MIL-C-26482	Series 1	21
KV-R	Cannon	NAS 1599	—	54
L	Burndy	MIL-C-26482	Series 1	21
LJT	Bendix	MIL-C-38999	Series I	41
LJT	Socapex	MIL-C-38999	Series I	41
LL3	Deutsch	MIL-C-81511	—	61
LL5/6	Deutsch	BS9540 F0001	Patt 602	Contact Tyco Electronics
LMB	Litton-Veam	Def. Stan. 59-35	Patt 121A	75
LPT	Deutsch	MIL-C-26482	Series 1	21
LS	Pyle	None	—	54
LTT	FKI ²	BS9522 F0029	Patt 616	41
M-T	Burndy	MIL-C-26482	Series 1	21
M723	Matrix	MIL-C-83723	Series II	19
MB1	Matrix	MIL-C-26482	Series 2	54
MB3	Matrix	MIL-C-83723	Series III	54
MB9	Matrix	MIL-C-38999	Series I and II	41
MD	Matrix	MIL-C-26482	Series 2	54
MDR	Deutsch	None	—	71
MF	Cannon	MIL-C-83723	Series III	54
MK12	Plessey	Def. Stan. 59-35	Patt 603	76, 77 ⁴
MK18	Plessey	Def. Stan. 59-35	Patt 608	79 ⁵
MK38	Plessey	MIL-C-38999	Series I	41

²FKI was previously Thorn.
⁴Code 77 braided version.
⁵Free connectors only.

Table B. Raychem Adapter Code by Manufacturer's Prefix (Continued)

Raychem Adapter Code (Continued)

Manufacturer's Prefix	Manufacturer ⁶	Connector Specification	Series/Class	Raychem Adapter Code
MK25	Plessey	MIL-C-38999	Series II	41
MK7	Plessey	DEF 5325-2	Patt 104	Contact Tyco Electronics
MK8	Plessey	Def. Stan. 59-35	Patt 105	76, 77 ⁴
ML94	Matrix	MIL-C-38999	Series IV	40
MQ3	Matrix	MIL-C-83723	Series III	54
MT3	Matrix	MIL-C-83723	Series III	54
MT93	Matrix	MIL-C-38999	Series III	40
P5	Plessey	NFL 54 125	—	76 or 24 ³ , 77 ⁴
PAT104D	AB Elec	Def. Stan. 59-35	Patt 104	Contact Tyco Electronics
PT	Socapex	MIL-C-26482	Series 1	76, 77 ⁴
PT	Teldix	MIL-C-26482	Series 1	76, 77 ⁴
PT-CE	Bendix	None	—	22
PT-G	Teldix	VG 95328	—	Contact Tyco Electronics
PT-SE	Socapex	MIL-C-26482	Series 1	76, 77 ⁴
PT-SE	Teldix	MIL-C-26482	Series 1	76, 77 ⁴
PT07	Bendix	MIL-C-26482	Series 1	24 ³
PT07SE	FKI ²	MIL-C-26482	Series 1	24 ³
PT33	FKI ²	BS9522 F0017	Patt 105	76, 77 ⁴
PT33SE	FKI ²	BS9522 N0001	Patt 603	76, 77 ⁴
PT44	FKI ²	BS9522 F0017	Patt 105	76, 77 ⁴
PT44SE	FKI ²	BS9522 N0001	Patt 603	76, 77 ⁴
PT55	FKI ²	BS9522 F0017	Patt 105	76, 77 ⁴
PT55SE	FKI ²	BS9522 N0001	Patt 603	76, 77 ⁴
PT77	FKI ²	BS9522 F0017	Patt 105	76, 77 ⁴
PT77SE	FKI ²	BS9522 N0001	Patt 603	76, 77 ⁴
PTG55	FKI ²	BS9522 F0017	Patt 105	76, 77 ⁴
PTG55SE	FKI ²	BS9522 N0001	Patt 603	76, 77 ⁴
PTS-DR	Bendix	MIL-C-26482	Series 2	54
PV7	Cannon	MIL-C-26482	Series 2	54
PVJ	Cannon	MIL-C-26482	Series 2	54
PVW	Cannon	—	—	54
PVX	Cannon	Def. Stan. 59-56	Patt 602	54
QDP	Bendix	None	—	32
QRP	AB Elec	—	—	78
QWL	Bendix	None	—	31
QWLD	Bendix	MIL-C-22992	Class C, J, R	32
RD1	Raychem	MIS-20065	—	54
RR	Deutsch	Def. Stan. 59-56	Patt 602	54
RR20	Deutsch	PAN 6432-2	—	54
RR50	Deutsch	PAN 6432-1	—	54
RR70	Deutsch	PAN 6432-2	—	54
RSM	Deutsch	None	—	71
RTK	Deutsch	None	—	71
SA	SAE	MIL-C-5015	MS3400	54
SB	Bendix	MIL-C-5015	Class E	18
SB-104	AB Elec	Def. Stan. 59-35	Patt 104	Contact Tyco Electronics
SB-M4	AB Elec	Def. Stan. 59-35	Patt 104	Contact Tyco Electronics
SB-MS	AB	BS9522 F0030	—	75
SC	Bendix	MIL-C-5015	MS3100 Class A	18
SCB	SICEM	VG 95234	—	Contact Tyco Electronics
SF	Bendix	MIL-C-5015	MS3100 Class E	18
SG	Bendix	MIL-C-5015	MS3100 Class E	18
SJT	Various	PAN 6433-2	—	47
SJT07	Various	PAN 6433-2	—	Contact Tyco Electronics
SLPT	Deutsch	MIL-C-26482	Series 1	76, 77 ⁴

²FKI was previously Thorn.
³Code 24 connectors have an internal accessory thread.
⁴Code 77 braided version.

Table B. Raychem Adapter Code by Manufacturer's Prefix (Continued)

Raychem Adapter Code (Continued)

Manufacturer's Prefix	Manufacturer ⁶	Connector Specification	Series/Class	Raychem Adapter Code
SM	Bendix	MIL-C-5015	MS3100 Class A, E, R	18
SPT	Bendix	MIL-C-26482	Series 1	76, 77 ⁴
SPT	Socapex	MIL-C-26482	Series 1	76, 77 ⁴
SPT07	Various	MIL-C-26482	Series 1	24 ³
STK	Deutsch	None	—	71
STT	FKI ²	BS9522 F0012	Patt 615	47
STT07	FKI ²	BS9522 F0012	Patt 615	Contact Tyco Electronics
T3 ¹	Pyle	MIL-C-38999	Series III	40
TRIM TRIO	Burndy	None	—	Contact Tyco Electronics
TT	FKI ²	BS9522 N0003	Patt 614	41
TV	FKI ² /Bendix	MIL-C-38999	Series III	40
TV-O-R	Bendix	MIL-C-38999	Series III and IV	40
TVP	FKI ² /Bendix	MIL-C-38999	Series III	40
TVPS	FKI ² /Bendix	MIL-C-38999	Series III	Contact Tyco Electronics
TVS	FKI ² /Bendix	MIL-C-38999	Series III	Contact Tyco Electronics
Tri-Start	Bendix	MIL-C-38999	Series III and IV	40
VPT	VEAM	MIL-C-26482	Series 1	21
VTT	FKI ²	MIL-C-38999	Series III	40
ZZY/ZZW	Pyle	MIL-C-26500	Class R, G (AL)	51
ZZY/ZZW	Pyle	MIL-C-26500	Class E (SST)	52

¹May be a number or letter depending upon connector style.

²FKI was previously Thorn.

³Code 24 connectors have an internal accessory thread.

⁴Code 77 braided version.

⁶Free connectors only.

⁶Some of the connector manufacturers names may have changed and may not exist. They are listed here to assist users who know them as listed names.

Table C. Raychem Adapter Code by Connector Specification

Raychem Adapter Code (Continued)

Connector Specification	Series/Class	Raychem Adapter Code
40M38277	—	41
40M39569	—	54
BS9520	G0001	41
BS9520	G0002	41
BS9520	G0003	40
BS9522 F0012	Patt 615	47
BS9522 F0014	Patt 104	Contact Tyco Electronics
BS9522 F0017	Patt 105	76
BS9522 F0020	Patt 608	79 ²
BS9522 F0023	—	Contact Tyco Electronics
BS9522 F0029	Patt 616	41
BS9522 F0030	Patt 121A	75
BS9522 F0032	Patt 121B	78
BS9522 F0042	—	54
BS9522 N0001	Patt 603	76
BS9522 N0003	Patt 614	41
BS9540 F0001	Patt 602	54
LN 29500	—	21
LN 29504	—	54
LN 29728	—	54
LN 29729	—	47
MIL-C-22992	Class C, J, R	32
MIL-C-26482	Series 1	21, 24 ¹
MIL-C-26482	Series 2	54
MIL-C-26500	Aluminum, Class F, G, R	51
MIL-C-26500	Stainless steel, Class E, K	52
MIL-C-28840	Class D	30
MIL-C-38999	Series I and II	41
MIL-C-38999	Series III and IV	40
MIL-C-5015	MS3400	54
MIL-C-5015	MS3100	18, 15 (with endbell)
MIL-C-5015	5MS	75
MIL-C-81511	Series 1, 2, 3, and 4	61
MIL-C-81703	Series 1, 2	71
MIL-C-81703	Series 3	54
MIL-C-83723	Series II	19
MIL-C-83723	Series I and III	54
MIL-C-85049/59	—	32
MIL-C-85049/60	—	54
MIL-C-85049/62	—	41
MIL-C-85049/69	—	40
MIS-20065	—	54
MVEE	5MS	75
NAS 1599	—	54
NFL 54120	—	Contact Tyco Electronics
NFL 54140	—	54
PAN 6432-1	—	54
PAN 6432-2	—	54
PAN 6433-1	—	41
PAN 6433-2	—	47
PRL 54125	—	21, 24 ¹
VG 95234	—	64 ^{***} , 66 ^{**} , 78 [*]
VG 95328	—	Contact Tyco Electronics
VG 95329	—	61
VG 96912	Series 2	41
VG 96912	Series 1	47

¹Code 24 connectors have an internal accessory thread.

²Free connectors only.

* AB connectors only

** VEAM standard

***VEAM panel mount

Selecting the Raychem Adapter Family

Raychem Adapter Family

Using Table D below and the Raychem adapter code you selected in Table A, B, or C, select the Raychem adapter family for the adapter type you chose (spin-coupling or Tinel-Lock).

With the alphanumeric prefix for that family you can then build the part number for your Raychem adapter.

Table D. Identification of Adapter Family Prefix by Raychem Adapter Code

Raychem Connector Code	Boot Adapter		Shielded Adapter			Tinel-Lock Adapter Straight, 45°, and 90°	Band-Strap Adapter*
	Solid (Fixed)	Spin-Coupling	Straight	45°	90°		
15	210M5	202M5	219M0	219M1	219M2	TXR 15	—
18	218M5	218M6	218M7	218M8	218M9	TXR 18	BND 18
19	201M7	201M4	—	—	—	—	—
21	203M6	203M9	206M0	206M1	206M2zx	TXR 21	BND 21
24	208M5	208M6	216M0	216M1	206M5	—	—
30	211M8	211M9	211M5	211M6	211M7	TXR 30	—
32	—	204M3	207M3	212M4	212M5	TXR 32	BND 32
40	209M3	209M4	208M7	208M8	208M9	TXR 40	BND 40
41	202M1	202M2	204M0	204M1	204M2	TXR 41	BND 41
47	202M8	202M7	210M0	210M1	210M2	TXR 47	BND 47
51	207M4	205M5	207M0	207M1	207M2	TXR 51	—
52	208M3	209M6	208M0	208M1	208M2	TXR 52	—
54	201M9	201M1	203M0	203M1	203M2	TXR 54	BND 54
61	202M3	202M4	205M0	205M1	205M2	TXR 61	—
71	203M5	202M9	217M0	217M1	217M2	TXR 71	—
75	228M5	228M7	227M0	227M1	227M2	TXR 75	—
76	225M6	225M5	—	—	—	TXR 76	—
77	228M6	228M8	228M0	228M1	228M2	—	—
78	225M4	225M3	225M0	225M1	225M2	TXR 78	—
79	—	229M3	229M1	229M2	229M0	TXR 79	—
80	215M4	213M5	213M6	213M7	213M8	TXR 80	—
81	214M3	214M4	214M5	214M6	214M7	TXR 81	—

Having Selected the Right Adapter Type and Raychem Adapter Family, You Can Now Construct a Part Number for the Adapter.

Raychem Part Number

1. Start with the alphanumeric prefix you selected in Table D. This will be the basis of your part number.
2. Add to the prefix the codes and designators required for your adapter type and application. These may include several or all of the following:

- Order number
- Manufacturer's prefix
- Material
- Finish
- Entry size
- Ring designator
- Option codes

Using the right codes and designators helps ensure that the adapter you select will meet the application requirements.

To determine which codes and designators you will need, use the Part numbering system shown below. To select the right codes and designators, turn to the pages that follow.

Part Numbering System

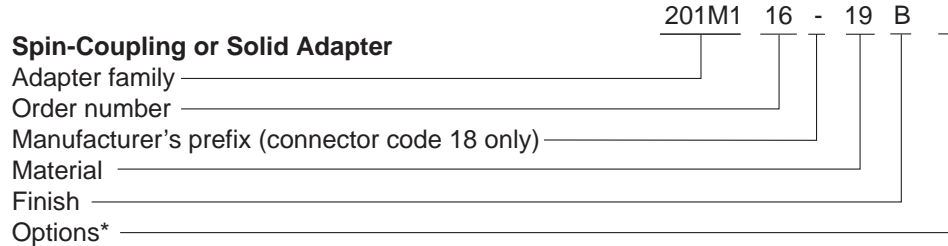

*For full range of options, consult Tyco Electronics.

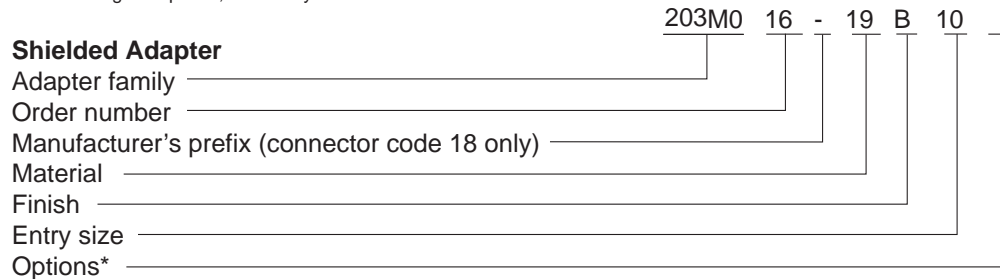

- Standard braid length (6") requires no modification code.
- Nonstandard braid length is stated in inches (12 = 12" length)

*For full range of options, consult Tyco Electronics.

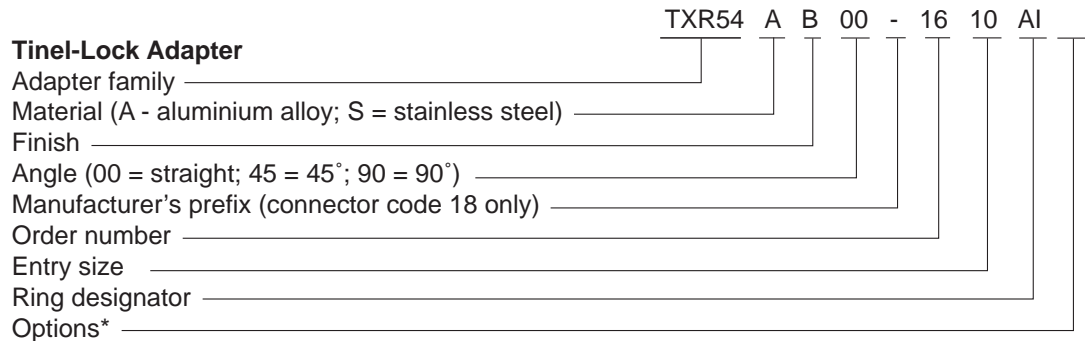

*For full range of options, consult Tyco Electronics.

Band Strap Adapters
Part Numbering System

Raychem Part Number (Continued)

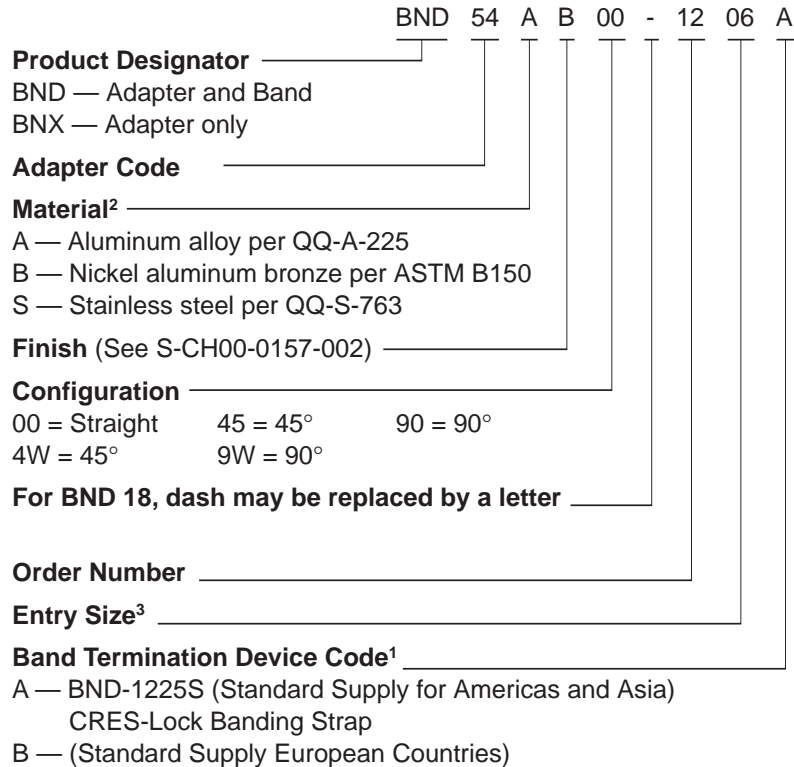

Notes:

1. See Drawings BND-1225S or BND-XX25S for information on bands. Adapter dimensions for "A" designation may be different than those listed in this catalog. Contact Tyco Electronics for Specification Control Drawing (SCD) for these adapters.
2. Alternative equivalent material specifications to those shown may be supplied at Tyco Electronics discretion.
3. For standard entry sizes see relevant specification control drawing. For entry sizes larger than standard (Type II Adapters), see sheets 3 and 4.

Band Strap Adapter
Modification Option Field
(Omit if not required)

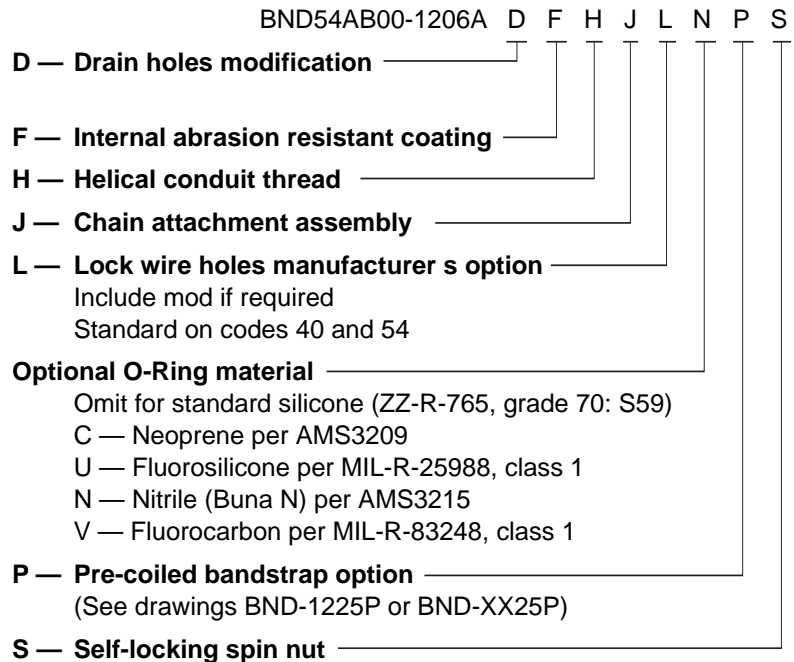

Selecting the Material and Finish

Adapter Selection

Material and Finish

To ensure optimum compatibility, select the adapter material and finish to match those of the connector.

Most circular connectors are manufactured from aluminum with a cadmium finish.

Raychem Material Codes

Material* Description	Material Code Solid, Spin-Coupling, and Shielded Adapters	Tinel-Lock Adapters	Typical Applications
Aluminum alloy	19	A	Standard material for normal applications
Stainless steel	62	S	Corrosion-resistant and high-temperature (firewall) applications
Nickel aluminum bronze	01	B	Exposed marine environments

*Other materials available upon request.

Raychem Finish Codes

Finish* Description	Color	Finish Code	Typical Applications
Cadmium, per QQ-P-416, Type II, Class 3	Olive drab	A	Corrosion-resistant conductive finish
Cadmium, per QQ-P-416, Type II, Class 3 over electroless nickel (500-hour salt-spray-resistant finish)	Olive drab	B	Corrosion resistance for exposed environments
Electroless nickel, per MIL-C-26074, Class 4, Grade B	—	C	High conductivity for optimum screening performance
Anodized, hard, per MIL-A-8625, Type III, Class 2	Black	G	Nonconductive finish for aluminum adapters
Passivated, per QQ-P-35 or MIL-S-5002	—	J	Nonconductive, corrosion-resistant finish for stainless steel adapters
Unplated, shotblast	—	W	Nonreflective finish for nickel aluminum bronze adapters

*Other finishes available upon request.

Entry Size

Determining the Wire Bundle Size

The entry size of an adapter is based on the size of the wire bundle. If you don't know the size of the wire bundle, measure a prototype or calculate the size.

Calculation of the wire bundle size is based on three values:

- Cable outside diameter (COD)
- Cable jacket thickness
- Jacketed cable diameter

Instructions for calculating these values follow.

COD Calculation

To calculate the cable outside diameter, first determine whether the wires in the bundle are of the same size or of different sizes.

COD Calculation for Wires of the Same Size

For bundles with wires that are all of the same size, follow these steps:

1. Determine the number of wires in the wire bundle.
2. Find the multiplication factor for that number in Table E shown on the next page.
3. Find the wire diameter in the Wire and Cable section (Section 9) of this catalog.
4. Multiply the wire diameter (from Step 3) by the multiplication factor (from Step 2) as shown below.

Formula: $D = Fd$

Where:

- D = Bundle diameter
- F = Multiplication factor
- d = Wire diameter

Example: A bundle of wires containing 27 x 44A0111-22

$F = 6.00$ (the multiplication factor for 27 wires from Table E)

$d = 1.19 \text{ mm } (.049 \text{ in})^*$

$D = 6 \times 1.19 \text{ mm } (6 \times .049 \text{ in})$

$D = 7.14 \text{ mm } (.294 \text{ in})$

*Diameter of 44A0111-22 wire obtained from the Wire and Cable Section 9 of this catalog.

COD Calculation for Wires of Different Sizes

To determine the wire bundle diameter when using wires of different sizes, follow these steps:

1. Determine the number of wires in the wire bundle.
2. Find the diameter of the wires in the Wire and Cable section of this catalog.
3. Calculate the cable outside diameter by using this formula:

$$\sqrt{D = 1.2 \sqrt{N_1d_1^2 + N_2d_2^2 + N_3d_3^2}}$$

Where:

- D = Bundle diameter
- N = Number of wires
- d = Diameter of wires

Example: A bundle of wires containing

3 x 44A0111-221* (1.192-mm dia.)

5 x 44A0111-201* (1.42-mm dia.)

1 x 44A0111-181* (1.65-mm dia.)

$$D = 1.2 \sqrt{3 \times 1.192^2 + 5 \times 1.42^2 + 1 \times 1.65^2}$$

$$D = 1.2 \sqrt{3 \times 1.4 + 5 \times 2.02 + 1 \times 2.7}$$

$$D = 1.2 \sqrt{4.2 + 10.1 + 2.7}$$

$$D = 1.2 \sqrt{17}$$

$$D = 1.2 \times 4.12$$

$$D = 4.95 \text{ mm}$$

*For wire information see the Wire and Cable Section 9 of this catalog.

Table E. Multiplication Factors for Wire Bundles with Equal Size Wires

This table provides multiplication factors for wire bundles of 1 to 61 wires.

To determine the approximate diameter of a wire bundle when the wires are all the same size, find the factor for the number of wires in the bundle and multiply the wire diameter by that factor.

Entry Size (Continued)

Number of Wires	Multiplication Factor	Number of Wires	Multiplication Factor
1	1.00	32	6.70
2	1.60	33	6.70
3	2.00	34	7.00
4	2.41	35	7.00
5	2.70	36	7.00
6	3.00	37	7.00
7	3.00	38	7.31
8	3.60	39	7.31
9	4.00	40	7.31
10	4.00	41	7.61
11	4.00	42	7.61
12	4.00	43	7.61
13	4.41	44	7.61
14	4.41	45	8.00
15	4.70	46	8.00
16	4.70	47	8.00
17	5.00	48	8.00
18	5.00	49	8.41
19	5.00	50	8.41
20	5.31	51	8.41
21	5.31	52	8.41
22	5.61	53	8.70
23	5.61	54	8.70
24	5.61	55	8.70
25	6.00	56	8.70
26	6.00	57	9.00
27	6.00	58	9.00
28	6.41	59	9.00
29	6.41	60	9.00
30	6.41	61	9.00
31	6.70	—	—

Entry Size (Continued)

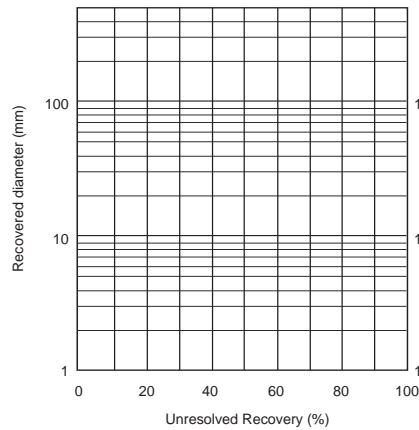

Figure 1.

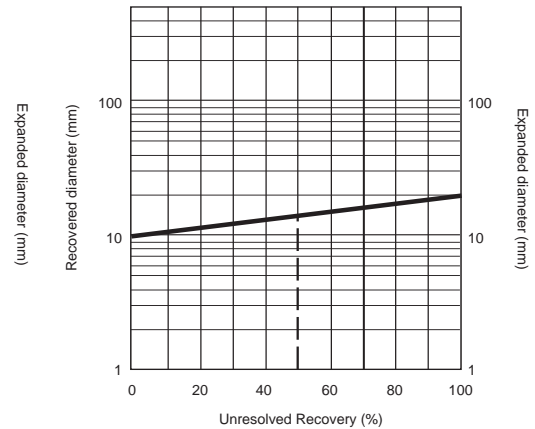

Figure 2.

Cable Jacket Thickness Calculation

To determine the wall thickness of a jacket over a wire bundle:

1. Use the chart in Figure 1 to determine the unresolved recovery of the tubing jacket
2. Use the chart in Figure 3 to determine the wall thickness reduction factor.
3. Calculate the jacket wall thickness by multiplying the fully shrunk wall thickness (as detailed in the Tubing section — Section 3 — of this catalog) by the wall thickness reduction factor.

Step 1. Determine the Unresolved Recovery of the Tubing Jacket.

1. Locate the recovered and expanded diameters of the chosen tubing size on the chart in Figure 1.
2. Lay a straight edge between the two values and pencil in a straight line connecting them.
3. Find the wire bundle diameter on the Expanded Diameter scale of the chart in Figure 1.
4. From the wire bundle diameter value, draw a straight horizontal line across the chart.
5. From the intersection of the line from step 3 and the line from step 2, read down vertically to the “Unresolved Recovery” for this combination.

Example (see Figure 2):

- Recovered tubing diameter = 10 mm
- Expanded tubing diameter = 20 mm
- Wire bundle diameter = 13 mm
- Unresolved recovery = 50%

Entry Size (Continued)

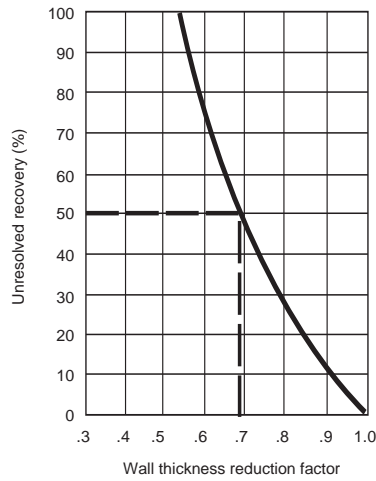

Figure 3.

Step 2. Find the Wall Thickness Reduction Factor.

1. On the Unresolved Recovery scale of the chart in Figure 3 above, find the unresolved recovery value determined in Step 1.
2. From the unresolved recovery value, draw a straight line across the chart to the curved line.
3. At the point where that line intersects the chart's curved line, read vertically down to the wall thickness reduction factor.

Example shown:

Unresolved recovery = 50%

Reduction factor = 0.68

Step 3. Calculate the Jacket Wall Thickness.

Multiply the fully shrunk wall thickness of the tubing by the reduction factor.

Example:

Fully shrunk wall thickness of tubing = 1.45 mm

Wall thickness reduction factor (from Figure 3) = 0.68

Jacket wall thickness = 1.4 x 0.68 = 0.99 mm

Note:

If the cable is to be shielded (screened), an addition must be made to the wire bundle diameter for the braid. In the example, 0.8 mm would be added to the wire bundle diameter for a single layer of RAY 101 (36 AWG) braid to make a total wire bundle diameter of 13.8 mm.

Entry Size (Continued)

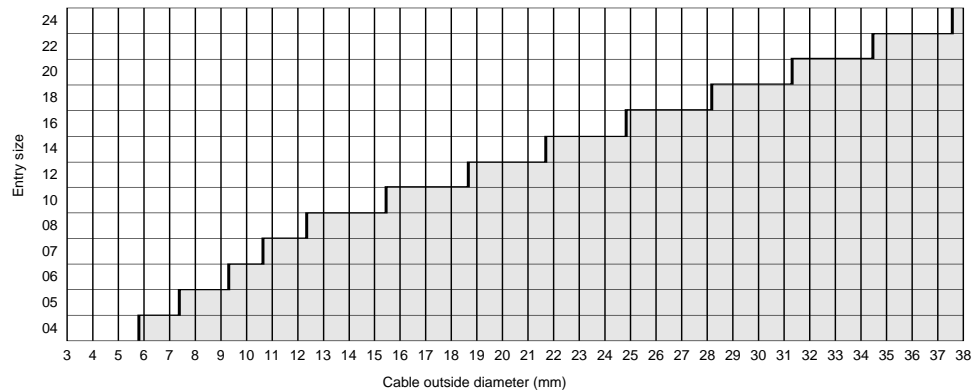

Figure 4. Entry Size by Cable Outside Diameter (in millimeters)

Determining the Entry Size

Once you have the wire bundle size, you can use the chart in Figure 4 to select the entry size. This chart shows the minimum entry sizes for cables from 3 to 38 mm [.118 to 1.496 in] in diameter. In other words, the white spaces on the chart represent all of the cable outside diameters each entry size will fit.

Follow these steps:

1. Find the cable diameter on the chart.
2. Note the lowest entry size that will fit the cable diameter

Braided Adapters

The extreme flexibility of the braid on these adapters accommodates a large range of cable diameters. It is therefore recommended that the standard entry size for any given adapter part number be specified as indicated on the relevant data sheet. Nonstandard entry sizes are available on special order.

Use the selection chart in Figure 4 to ensure that the standard entry size will pass over the jacketed cable diameter.

Tinel-Lock Adapters

With Tinel-Lock adapters, the cable braid must be opened up to fit onto the outside diameter of the adapter entry. For optimum performance, select the smallest entry size that will pass over the jacketed cable diameter. Repair of the connector will be easier using the boot and shield rollback if a slightly larger than minimum entry size is used.

The selection chart in Figure 4 shows the minimum entry sizes for cable diameters in the range of 3 mm to 38 mm. This will ensure that the jacketed cable passes through the adapter for easy assembly.

It should be checked to be sure the braid will open sufficiently to fit the entry size selected and to ensure that the braid and boot can be rolled back.

Ray 101 Tinned-Copper Braid

Ray 101 Data

Adapter Selection

Entry Size (Continued)

Tyco Electronics manufactures a range of Raychem tubular braided shields (sometimes called "screens") that are used for shielding hand-built harnesses.

These braids are specially designed to have:

- Good surface transfer impedance
- Large opening ratio
- Good handling characteristics
- Compatibility with Tinel-Lock adapters

Sizes are available to cover wire bundle diameters from 2.5 to 38 [.10 to 1.50]. The table below shows the wire bundle diameter range for each braid size and also shows which adapter entry sizes are compatible with each of these braids and bundle diameters.

The entry sizes do not allow for the additional thickness of the braid and the heat-shrunk cable jacket.

Part No.	Number of Carriers	Number of Ends/Carrier	Individual Strand Size (mm/AWG)	Wire Bundle Diameter Range			Tinel Adapter Entry Size (Single-Layer Braid)
				Min.	Max.	Wall Thickness (Nom.)	
RAY 101-3.0	16	10	0.1 [38]	2.5 [.10]	5.0 [.20]	N/A	N/A
RAY 101-4.0	24	7	0.13 [36]	3.5 [.14]	7.5 [.30]	0.4 [.02]	04*
RAY 101-6.0	24	9	0.13 [36]	4.0 [.16]	9.5 [.37]	0.4 [.02]	04, 05, 06*, 07
RAY 101-7.5	24	14	0.13 [36]	6.0 [.24]	14.0 [.55]	0.4 [.02]	05, 06, 07, 10*
RAY 101-10.0	36	12	0.13 [36]	8.0 [.31]	22.0 [.87]	0.4 [.02]	07, 08, 10 12*
RAY 101-12.5	36	15	0.13 [36]	10.0 [.39]	24.0 [.94]	0.4 [.02]	08, 10, 12, 14, 16*
RAY 101-20.0	48	16	0.13 [36]	16.0 [.63]	38.0 [1.50]	0.4 [.02]	12, 14, 16, 18, 20, 22

*Combination is not preferred; use only if absolutely necessary.



Tinel-Lock Ring

Tinel-Lock Ring and Braid

The Tinel-Lock ring designator must be specified according to the type of cable braid used, and is added to the part number after the adapter entry size. There are two types of ring, AI and BI, for each entry size.

Tinel rings are marked with thermochromic paint, which changes color when the correct installation temperature is reached. BI-type rings are identified with a red spot.

Braid type, material, and construction are variable. If in doubt, contact Tyco Electronics for advice.

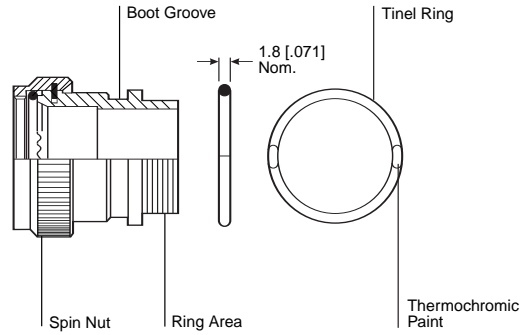

Braid Type	Ring Designator
Single layer 36 AWG	AI
Single layer 34 AWG	AI
Single layer 32 AWG	BI
Single layer 30 AWG	BI
Double layer 36 AWG	BI
Double layer 34 AWG	BI

A or B = Size of Braid I = Insulating Layer

Table F.
Wire Gauge (AWG) to
Diameter Cross-Reference
Use this table to establish wire
gauge if not known.

Wire Gauge (AWG)	Diameter
40	0.079 [0.0031]
39	0.089 [0.0035]
38	0.102 [0.0040]
37	0.114 [0.0045]
36	0.127 [0.0050]
35	0.142 [0.0056]
34	0.160 [0.0063]
33	0.180 [0.0071]
32	0.203 [0.0080]
31	0.226 [0.0089]
30	0.254 [0.0100]
29	0.287 [0.0113]
28	0.320 [0.0126]

*Note: It may be necessary to use an 'A' rather than a 'B' ring on entry sizes 04-07 when terminating a multicore cable with double layer machined braid. Braid applied by machine provides less size flexibility than pull-on braid at the smaller entry sizes. If disturbance during assembly causes loss of braid lay, grip of the tinel ring may be affected. Evaluation is recommended. Contact Tyco Electronics for more information.

Available in:	Americas	Europe	Asia Pacific
	■	■	■

CRES-Lock Bands



The CRES-Lock (Americas and Asia)/BND (Europe) band strap designator must be specified when using a band adapter. There are two forms of band that are available — precoiled and straight. Straight is a standard configuration and does not require any notation. If precoiled bands

are required, an option P must be used. Refer to CH00-0250-016 drawing for more detailed information. CRES-Lock band strap comes in 12 inch length and BND band strap comes in 14 inch length. These fit all entry sizes for both the CRES-Lock and BND adapter.

Use the band strap designation A in Americas and Asia and B for Europe.

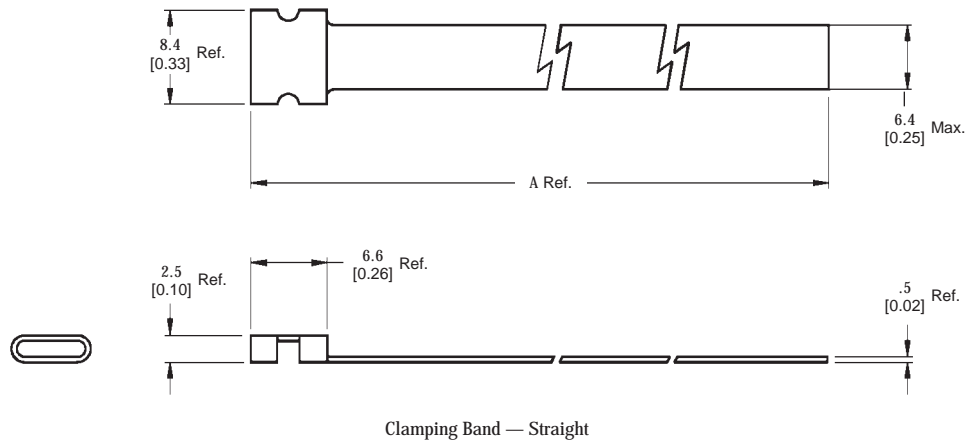

Notes:

1. The band is constructed from 300 Series passivated stainless steel and is designed to be installed with either a hand or electric banding tool. Contact Tyco Electronics for further information.
2. The band will be permanently marked with code identification number and full part number (e.g. 06090-BND-1225S).

Part Number	Entry Sizes	A Ref. ±1.5 [±0.06]
BND-1225S	03 to 24	305.0 12.00
BND-1425S	03 to 34	362.0 14.25

Available in:	Americas	Europe	Asia Pacific
	■	■	■

Braided Adapters

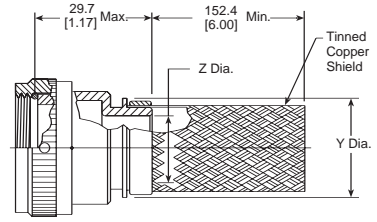

218M7XX-XXXXX

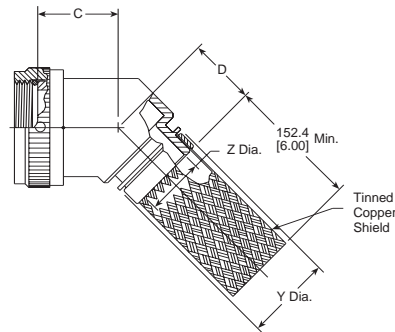

218M8XX-XXXXX

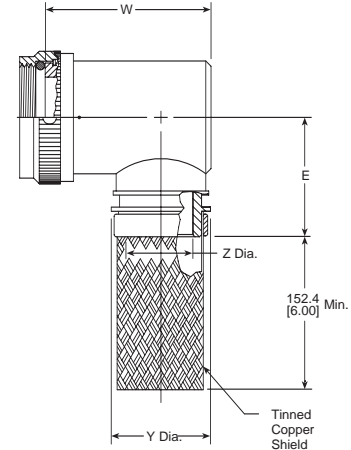

218M9XX-XXXXX

Manufacturer Code	Connector Manufacturer
	MS3100/3101/3106
A	Amphenol-Class A
B	Bendix-Class A/E/R
C	Cannon-Class A/E/R
D*	Unknown-Class A/E/R
R	Amphenol-Class R
—	Manufacturer code not required

*Additional pieces supplied when manufacturer is unknown. All thread sizes for order number apply.

Available in:	Americas	Europe	Asia Pacific
	■	■	■

Braided Adapters
(continued)

Table of Dimensions

Order No.	Shell Size	Manufacturer Code	Max. Entry Size, Type 1**	Thread	Dimensions		
					C Max.	D Max.	E Max.
08	8S	B	04	.375-32 UNEF	20.3 [0.80]	23.4 [0.92]	31.2 [1.23]
08	8S	C	04	.438-28 UNEF	20.3 [0.80]	23.4 [0.92]	31.2 [1.23]
08	8S	A, R	04	.438-27 UNS	20.3 [0.80]	23.4 [0.92]	31.2 [1.23]
08	8S	D	04	See * above.	20.3 [0.80]	23.4 [0.92]	31.2 [1.23]
10	10S	—	06	.500-28 UNEF	21.1 [0.83]	24.1 [0.95]	31.2 [1.23]
11	10SL	C	07	.562-24 UNEF	21.1 [0.83]	24.1 [0.83]	31.2 [1.23]
11	10SL	A, B, R	07	.625-24 UNEF	21.1 [0.83]	24.1 [0.95]	31.2 [1.23]
11	10SL	D	07	See * above.	21.1 [0.83]	24.1 [0.95]	31.2 [1.23]
12	12 & 12S	B, C	08	.625-24 UNEF	21.1 [0.83]	24.1 [0.95]	31.2 [1.23]
12	12 & 12S	A, R	08	.688-24 UNEF	21.8 [0.86]	24.9 [0.98]	33.0 [1.30]
12	12 & 12S	D	08	See * above.	21.8 [0.86]	24.9 [0.98]	33.0 [1.30]
14	14 & 14S	—	10	.750-20 UNEF	21.8 [0.86]	24.9 [0.98]	33.0 [1.30]
16	16 & 16S	—	12	.875-20 UNEF	22.6 [0.89]	25.9 [1.02]	36.1 [1.42]
18	18	—	12	1.000-20 UNEF	23.4 [0.92]	26.7 [1.05]	37.6 [1.48]
20	20	A, B, C	16	1.125-18 UNEF	24.1 [0.95]	27.4 [1.08]	39.4 [1.55]
20	20	R	16	1.125-24 UNS	24.1 [0.95]	27.4 [1.08]	39.4 [1.55]
20	20	D	16	See * above.	24.1 [0.95]	27.4 [1.08]	39.4 [1.55]
22	22	—	18	1.250-18 UNEF	24.9 [0.98]	28.2 [1.11]	40.9 [1.61]
24	24	—	20	1.375-18 UNEF	24.9 [0.98]	28.2 [1.11]	42.4 [1.67]
28	28	—	24	1.625-18 UNEF	27.4 [1.08]	29.7 [1.17]	47.2 [1.86]
32	32	B, C	24	1.875-16 UN	28.2 [1.11]	31.2 [1.23]	48.8 [1.92]
32	32	A, R	24	1.906-18 UN	28.2 [1.11]	31.2 [1.23]	48.8 [1.92]
32	32	D	24	See * above.	28.2 [1.11]	31.2 [1.23]	48.8 [1.92]
36	36	B	24	2.062-16 UNS	31.2 [1.23]	32.3 [1.27]	52.1 [2.05]
36	36	R	24	2.062-20 UNS	31.2 [1.23]	32.3 [1.27]	52.1 [2.05]
36	36	C	24	2.125-16 UN	31.2 [1.23]	32.3 [1.27]	52.1 [2.05]
36	36	A	24	2.125-18 UNS	31.2 [1.23]	32.3 [1.27]	52.1 [2.05]
36	36	D	24	See * above.	31.2 [1.23]	32.3 [1.27]	52.1 [2.05]
40	40	B	24	2.312-16 UNS	32.3 [1.27]	33.0 [1.30]	55.1 [2.17]
40	40	A, C, R	24	2.375-16 UN	32.3 [1.27]	33.0 [1.30]	55.1 [2.17]
40	40	D	24	See * above.	32.3 [1.27]	33.0 [1.30]	55.1 [2.17]
44	44	—	24	2.625-16 UN	34.0 [1.34]	34.5 [1.36]	61.5 [2.42]
48	48	C	24	2.812-18 UNS	34.0 [1.34]	34.5 [1.36]	61.5 [2.42]
48	48	A, R	24	2.875-16 UN	34.0 [1.34]	34.5 [1.36]	61.5 [2.42]
48	48	D	24	See * above.	34.0 [1.34]	34.5 [1.36]	61.5 [2.42]

**For larger than maximum type 1 entry sizes, a two-piece adapter will be supplied. Contact Tyco Electronics for information.

Entry Size Dimensions

Entry Size	Dimensions		
	Z Dia. +0.25-0.5	Y Dia. ±0.38	W Max.
04	6.35 [0.250]	11.58 [0.456]	31.2 [1.23]
05	7.92 [0.312]	13.08 [0.515]	32.8 [1.29]
06	9.53 [0.375]	14.76 [0.581]	34.3 [1.35]
07	11.13 [0.438]	16.33 [0.643]	36.1 [1.42]
08	12.70 [0.500]	17.91 [0.705]	37.6 [1.48]
10	15.88 [0.625]	21.11 [0.831]	40.6 [1.60]
12	19.05 [0.750]	24.21 [0.953]	43.9 [1.73]
14	22.23 [0.875]	27.46 [1.081]	47.0 [1.85]
16	25.40 [1.000]	30.61 [1.205]	50.8 [2.00]
18	28.58 [1.125]	35.08 [1.381]	54.1 [2.13]
20	31.75 [1.250]	38.25 [1.506]	57.2 [2.25]
22	34.93 [1.375]	41.43 [1.631]	—
24	38.10 [1.500]	44.60 [1.756]	—

Solid Adapters



Code 18 MIL-C-5015 (MS3100) (Continued)

Manufacturer Code	Connector Manufacturer MS3100/3101/3106
A	Amphenol-Class A
B	Bendix-Class A/E/R
C	Cannon-Class A/E/R
D*	Unknown-Class A/E/R
R	Amphenol-Class R
—	Manufacturer code not required

*Additional pieces supplied when manufacturer is unknown. All thread sizes for order number apply.

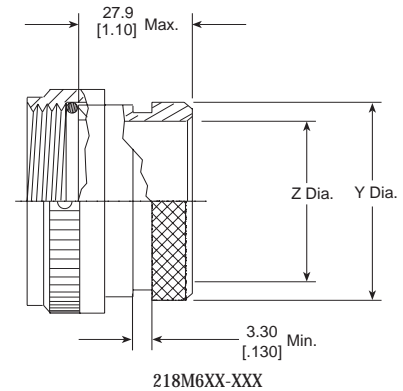

Table of Dimensions

Order No.	Shell Size	Manufacturer Code	Thread	Dimensions	
				Y ±0.5	Z Min.
08	8S	B	.375-32 UNEF	13.2 [0.52]	6.22 [0.24]
08	8S	C	.438-28 UNEF	13.2 [0.52]	7.80 [0.31]
08	8S	A, R	.438-27 UNS	13.2 [0.52]	7.80 [0.31]
08	8S	D	See * above.	13.2 [0.52]	7.80 [0.31]
10	10S	—	.500-28 UNEF	15.0 [0.59]	9.40 [0.37]
11	10SL	C	.562-24 UNEF	15.0 [0.59]	11.00 [0.43]
11	10SL	A, B, R	.625-24 UNEF	19.3 [0.76]	12.57 [0.49]
11	10SL	D	See * above.	19.3 [0.76]	11.00 [0.43]
12	12 & 12S	B, C	.625-24 UNEF	19.3 [0.76]	12.57 [0.49]
12	12 & 12S	A, R	.688-24 UNEF	19.3 [0.76]	14.15 [0.56]
12	12 & 12S	D	See * above.	19.3 [0.76]	12.57 [0.49]
14	14 & 14S	—	.750-20 UNEF	20.9 [0.82]	15.75 [0.62]
16	16 & 16S	—	.875-20 UNEF	24.1 [0.95]	18.92 [0.74]
18	18	—	1.000 - 20 UNEF	26.1 [1.03]	20.50 [0.81]
20	20	A, B, C	1.125-18 UNEF	34.0 [1.34]	25.27 [0.99]
20	20	R	1.125-24 UNS	34.0 [1.34]	25.27 [0.99]
20	20	D	See * above.	34.0 [1.34]	25.27 [0.99]
22	22	—	1.250-18 UNEF	36.3 [1.43]	28.45 [1.12]
24	24	—	1.375-18 UNEF	40.5 [1.59]	31.62 [1.24]
28	28	—	1.625-18 UNEF	43.0 [1.69]	34.80 [1.37]
32	32	B, C	1.875-16 UN	48.4 [1.91]	41.15 [1.62]
32	32	A, R	1.906-18 UN	48.4 [1.91]	41.15 [1.62]
32	32	D	See * above.	48.4 [1.91]	41.15 [1.62]
36	36	B	2.062-16 UNS	54.7 [2.15]	47.50 [1.87]
36	36	R	2.062-20 UNS	54.7 [2.15]	47.50 [1.87]
36	36	C	2.125-16 UN	54.7 [2.15]	47.50 [1.87]
36	36	A	2.125-18 UNS	54.7 [2.15]	47.50 [1.87]
36	36	D	See * above.	54.7 [2.15]	47.50 [1.87]
40	40	B	2.312-16 UNS	60.6 [2.39]	53.85 [2.12]
40	40	A, C, R	2.375-16 UN	60.6 [2.39]	53.85 [2.12]
40	40	D	See * above.	60.6 [2.39]	53.85 [2.12]
44	44	—	2.625-16 UN	67.1 [2.64]	60.20 [2.37]
48	48	C	2.812-18 UNS	73.5 [2.89]	66.55 [2.62]
48	48	A, R	2.875-16 UN	73.5 [2.89]	66.55 [2.62]
48	48	D	See * above.	73.5 [2.89]	66.55 [2.62]

Available in:	Americas	Europe	Asia Pacific
	■	■	■

Solid Adapters
(continued)

Molded Part Selection Guide
(Solid)

Y Diameter	Standard K Parts			Low-Profile D Parts		
	Straight Part No.	90° Part No.	Cable OD (min.)	Straight Part No.	90° Part No.	Cable OD (Min.)
13.2 [0.52]	202W232	—	4.3 [0.19]	—	—	—
13.2 [0.52]	202K121	222K121	5.6 [0.22]	202D211	222D211	6.4 [0.25]
15.0 [0.59]	202K132	222K132	5.9 [0.23]	202D221	222D221	7.4 [0.29]
19.2 [0.76]	202K142	222K142	7.1 [0.28]	202D232	222D232	8.4 [0.33]
20.9 [0.82]	202K142	222K142	7.1 [0.28]	202D232	222D232	8.4 [0.33]
24.1 [0.95]	202K153	222K152	8.4 [0.33]	202D242	222D242	9.7 [0.38]
26.1 [1.03]	202K153	222K152	8.4 [0.33]	202D242	222D242	9.7 [0.38]
34.0 [1.34]	202K163	222K163	9.9 [0.33]	202D253	222D253	10.4 [0.41]
36.2 [1.43]	202K174	222K174	15.7 [0.62]	202D263	222D263	12.2 [0.48]
40.5 [1.59]	202K174	222K174	15.7 [0.62]	202D263	222D263	12.2 [0.48]
43.0 [1.69]	202K174	222K174	15.7 [0.62]	202D263	222D263	12.2 [0.48]
48.4 [1.91]	202K185	222K185	16.8 [0.66]	202D274	222D274	14.3 [0.56]
54.7 [2.15]	202K185	222K185	16.8 [0.66]	202D274	222D274	14.3 [0.56]
60.6 [2.39]	—	—	—	202D285	222D285	17.5 [0.68]
67.1 [2.64]	—	—	—	202D296	222D296	19.6 [0.76]
73.5 [2.89]	—	—	—	202D299	222D299	22.9 [0.89]

Uniboot Parts

Y Diameter	Part No.	Cable OD (Min.)
13.2 [0.52]	202C611	4.8 [0.19]
15.0 [0.59]	202C621	8.1 [0.32]
19.3 [0.76]	202C621	8.1 [0.32]
20.9 [0.82]	202C632	12.7 [0.50]
24.1 [0.95]	202C632	12.7 [0.50]
26.1 [1.03]	202C642	17.5 [0.69]
34.0 [1.34]	202C653	22.4 [0.88]
36.3 [1.43]	202C653	22.4 [0.88]
40.5 [1.59]	202C653	22.4 [0.88]
43.0 [1.69]	202C663	22.9 [0.90]
48.4 [1.91]	202C663	22.9 [0.90]
54.7 [2.15]	202C663	22.9 [0.90]
60.6 [2.39]	202C663	22.9 [0.90]
67.1 [2.64]	202C663	22.9 [0.90]
73.5 [2.89]	202C663	22.9 [0.90]

Spin-Coupling Adapters



Code 18 MIL-C-5015 (MS3100) (Continued)

Manufacturer Code	Connector Manufacturer MS3100/3101/3106
A	Amphenol-Class A
B	Bendix-Class A/E/R
C	Cannon-Class A/E/R
D*	Unknown-Class A/E/R
R	Amphenol-Class R
—	Manufacturer code not required

*Additional pieces supplied when manufacturer is unknown. All thread sizes for order number apply.

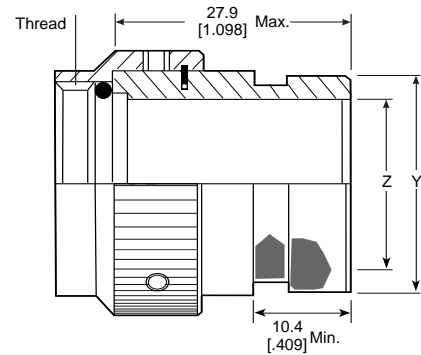

218M6XX-XXX

Table of Dimensions

Order No.	Shell Size	Manufacturer Code	Thread	Dimensions	
				Y ±0.5	Z Min.
08	8S	B	.375-32 UNEF	13.2 [0.52]	6.22 [0.24]
08	8S	C	.438-28 UNEF	13.2 [0.52]	7.80 [0.31]
08	8S	A, R	.438-27 UNS	13.2 [0.52]	7.80 [0.31]
08	8S	D	See * above.	13.2 [0.52]	7.80 [0.31]
10	10S	—	.500-28 UNEF	15.0 [0.59]	9.40 [0.37]
11	10SL	C	.562-24 UNEF	15.0 [0.59]	11.00 [0.43]
11	10SL	A, B, R	.625-24 UNEF	19.3 [0.76]	12.57 [0.49]
11	10SL	D	See * above.	19.3 [0.76]	11.00 [0.43]
12	12 & 12S	B, C	.625-24 UNEF	19.3 [0.76]	12.57 [0.49]
12	12 & 12S	A, R	.688-24 UNEF	19.3 [0.76]	14.15 [0.56]
12	12 & 12S	D	See * above.	19.3 [0.76]	12.57 [0.49]
14	14 & 14S	—	.750-20 UNEF	20.9 [0.82]	15.75 [0.62]
16	16 & 16S	—	.875-20 UNEF	24.1 [0.95]	18.92 [0.74]
18	18	—	1.000 - 20 UNEF	26.1 [1.03]	20.50 [0.81]
20	20	A, B, C	1.125-18 UNEF	34.0 [1.34]	25.27 [0.99]
20	20	R	1.125-24 UNS	34.0 [1.34]	25.27 [0.99]
20	20	D	See * above.	34.0 [1.34]	25.27 [0.99]
22	22	—	1.250-18 UNEF	36.3 [1.43]	28.45 [1.12]
24	24	—	1.375-18 UNEF	40.5 [1.59]	31.62 [1.24]
28	28	—	1.625-18 UNEF	43.0 [1.69]	34.80 [1.37]
32	32	B, C	1.875-16 UN	48.4 [1.91]	41.15 [1.62]
32	32	A, R	1.906-18 UN	48.4 [1.91]	41.15 [1.62]
32	32	D	See * above.	48.4 [1.91]	41.15 [1.62]
36	36	B	2.062-16 UNS	54.7 [2.15]	47.50 [1.87]
36	36	R	2.062-20 UNS	54.7 [2.15]	47.50 [1.87]
36	36	C	2.125-16 UN	54.7 [2.15]	47.50 [1.87]
36	36	A	2.125-18 UNS	54.7 [2.15]	47.50 [1.87]
36	36	D	See * above.	54.7 [2.15]	47.50 [1.87]
40	40	B	2.312-16 UNS	60.6 [2.39]	53.85 [2.12]
40	40	A, C, R	2.375-16 UN	60.6 [2.39]	53.85 [2.12]
40	40	D	See * above	60.6 [2.39]	53.85 [2.12]
44	44	—	2.625-16 UN	67.1 [2.64]	60.20 [2.37]
48	48	C	2.812-18 UNS	73.5 [2.89]	66.55 [2.62]
48	48	A, R	2.875-16 UN	73.5 [2.89]	66.55 [2.62]
48	48	D	See * above	73.5 [2.89]	66.55 [2.62]

Available in:	Americas	Europe	Asia Pacific
	■	■	■

Code 18 MIL-C-5015 (MS3100) (Continued)

Y Diameter	Standard K Parts			Low-Profile D Parts		
	Straight Part No.	90° Part No.	Cable OD (Min.)	Straight Part No.	90° Part No.	Cable OD (Min.)
13.2 [0.52]		202W232	4.3 [0.19]			
13.2 [0.52]	202K121	222K121	5.6 [0.22]	202D211	222D211	6.4 [0.25]
15.0 [0.59]	202K132	222K132	5.9 [0.23]	202D221	222D221	7.4 [0.29]
19.2 [0.76]	202K142	222K142	7.1 [0.28]	202D232	222D232	8.4 [0.33]
20.9 [0.82]	202K142	222K142	7.1 [0.28]	202D232	222D232	8.4 [0.33]
24.1 [0.95]	202K153	222K152	8.4 [0.33]	202D242	222D242	9.7 [0.38]
26.1 [1.03]	202K153	222K152	8.4 [0.33]	202D242	222D242	9.7 [0.38]
34.0 [1.34]	202K163	222K163	9.9 [0.33]	202D253	222D253	10.4 [0.41]
36.2 [1.43]	202K174	222K174	15.7 [0.62]	202D263	222D263	12.2 [0.48]
40.5 [1.59]	202K174	222K174	15.7 [0.62]	202D263	222D263	12.2 [0.48]
43.0 [1.69]	202K174	222K174	15.7 [0.62]	202D263	222D263	12.2 [0.48]
48.4 [1.91]	202K185	222K185	16.8 [0.66]	202D274	222D274	14.3 [0.56]
54.7 [2.15]	202K185	222K185	16.8 [0.66]	202D274	222D274	14.3 [0.56]

Uniboot Parts

Y Diameter	Part No.	Cable OD (Min.)
13.2 [0.52]	202C611	4.8 [0.19]
15.0 [0.59]	202C621	8.1 [0.32]
19.3 [0.76]	202C621	8.1 [0.32]
20.9 [0.82]	202C632	12.7 [0.50]
24.1 [0.95]	202C632	12.7 [0.50]
26.1 [1.03]	202C642	17.5 [0.69]
34.0 [1.34]	202C653	22.4 [0.88]
36.3 [1.43]	202C653	22.4 [0.88]
40.5 [1.59]	202C653	22.4 [0.88]
43.0 [1.69]	202C663	22.9 [0.90]
48.4 [1.91]	202C663	22.9 [0.90]
54.7 [2.15]	202C663	22.9 [0.90]

Tinel-Lock Adapters

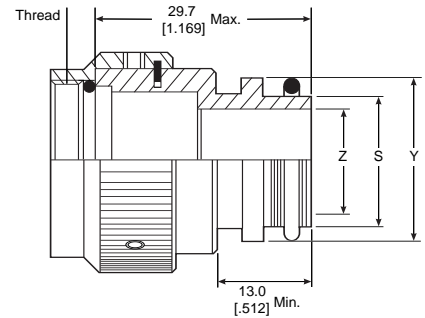

TXR18XX00-XXXXXX

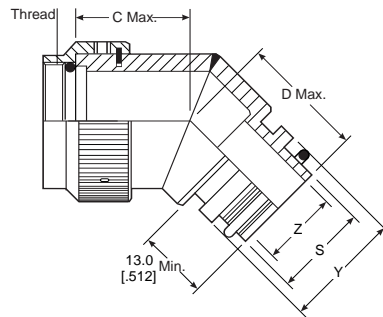

TXR18XX45-XXXXXX

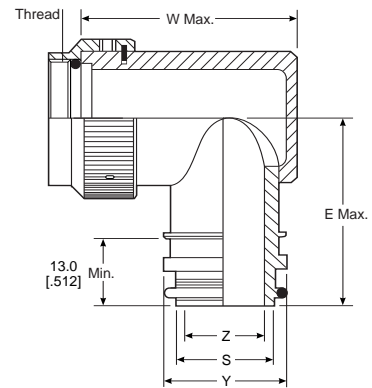

TXR18XX90-XXXXXX

Manufacturer Code	Connector Manufacturer MS3100/3101/3106
A	Amphenol-Class A
B	Bendix-Class A/E/R
C	Cannon-Class A/E/R
D*	Unknown-Class A/E/R
R	Amphenol-Class R
—	Manufacturer code not required

*Additional pieces supplied when manufacturer is unknown. All thread sizes for order number apply.

Available in:	Americas	Europe	Asia Pacific
	■	■	■

Tinel-Lock Adapters
(continued)

Table of Dimensions

Order No.	Shell Size	Manufacturer Code	Max. Entry Size, Type 1**	Thread	Dimensions		
					C Max.	D Max.	E Max.
08	8S	B	04	.375-32 UNEF	20.3 [0.80]	23.4 [0.92]	31.2 [1.23]
08	8S	C	04	.438-28 UNEF	20.3 [0.80]	23.4 [0.92]	31.2 [1.23]
08	8S	A, R	04	.438-27 UNS	20.3 [0.80]	23.4 [0.92]	31.2 [1.23]
08	8S	D	04	*	20.3 [0.80]	23.4 [0.92]	31.2 [1.23]
10	10S	—	06	.500-28 UNEF	21.1 [0.83]	24.1 [0.95]	31.2 [1.23]
11	10SL	C	07	.562-24 UNEF	21.1 [0.83]	24.1 [0.83]	31.2 [1.23]
11	10SL	A, B, R	07	.625-24 UNEF	21.1 [0.83]	24.1 [0.95]	31.2 [1.23]
11	10SL	D	07	*	21.1 [0.83]	24.1 [0.95]	31.2 [1.23]
12	12 & 12S	B, C	08	.625-24 UNEF	21.1 [0.83]	24.1 [0.95]	31.2 [1.23]
12	12 & 12S	A, R	08	.688-24 UNEF	21.8 [0.86]	24.9 [0.98]	33.0 [1.30]
12	12 & 12S	D	08	*	21.8 [0.86]	24.9 [0.98]	33.0 [1.30]
14	14 & 14S	—	10	.750-20 UNEF	21.8 [0.86]	24.9 [0.98]	33.0 [1.30]
16	16 & 16S	—	12	.875-20 UNEF	22.6 [0.89]	25.9 [1.02]	36.1 [1.42]
18	18	—	12	1.000-20 UNEF	23.4 [0.92]	26.7 [1.05]	37.6 [1.48]
20	20	A, B, C	16	1.125-18 UNEF	24.1 [0.95]	27.4 [1.08]	39.4 [1.55]
20	20	R	16	1.125-24 UNS	24.1 [0.95]	27.4 [1.08]	39.4 [1.55]
20	20	D	16	*	24.1 [0.95]	27.4 [1.08]	39.4 [1.55]
22	22	—	18	1.250-18 UNEF	24.9 [0.98]	28.2 [1.11]	40.9 [1.61]
24	24	—	20	1.375-18 UNEF	24.9 [0.98]	28.2 [1.11]	42.4 [1.67]
28	28	—	24	1.625-18 UNEF	27.4 [1.08]	29.7 [1.17]	47.2 [1.86]
32	32	B, C	24	1.875-16 UN	28.2 [1.11]	31.2 [1.23]	48.8 [1.92]
32	32	A, R	24	1.906-18 UN	28.2 [1.11]	31.2 [1.23]	48.8 [1.92]
32	32	D	24	*	28.2 [1.11]	31.2 [1.23]	48.8 [1.92]
36	36	B	24	2.062-16 UNS	31.2 [1.23]	32.3 [1.27]	52.1 [2.05]
36	36	R	24	2.062-20 UNS	31.2 [1.23]	32.3 [1.27]	52.1 [2.05]
36	36	C	24	2.125-16 UN	31.2 [1.23]	32.3 [1.27]	52.1 [2.05]
36	36	A	24	2.125-18 UNS	31.2 [1.23]	32.3 [1.27]	52.1 [2.05]
36	36	D	24	*	31.2 [1.23]	32.3 [1.27]	52.1 [2.05]
40	40	B	24	2.312-16 UNS	32.3 [1.27]	33.0 [1.30]	55.1 [2.17]
40	40	A, C, R	24	2.375-16 UN	32.3 [1.27]	33.0 [1.30]	55.1 [2.17]
40	40	D	24	*	32.3 [1.27]	33.0 [1.30]	55.1 [2.17]
44	44	—	24	2.625-16 UN	34.0 [1.34]	34.5 [1.36]	61.5 [2.42]
48	48	C	24	2.812-18 UNS	34.0 [1.34]	34.5 [1.36]	61.5 [2.42]
48	48	A, R	24	2.875-16 UN	34.0 [1.34]	34.5 [1.36]	61.5 [2.42]
48	48	D	24	*	34.0 [1.34]	34.5 [1.36]	61.5 [2.42]

* Additional pieces, etc. (from page 6-36)

**For larger than maximum type 1 entry sizes, a two-piece adapter will be supplied. Contact Tyco Electronics for information.

Tinel-Lock Adapters
(continued)

Entry Size Dimensions

Entry Size	Dimensions			
	Z Dia. +0.25-0.5	S Diameter (min.-max.)	Y Dia. ±0.38	W Max.
04	6.35 [0.25]	9.39-9.56 [0.37-0.38]	13.97 [0.55]	31.50 [1.24]
05	7.92 [0.31]	10.97-11.13 [0.43-0.44]	15.54 [0.61]	34.30 [1.35]
06	9.52 [0.37]	12.57-12.73 [0.49-0.50]	17.14 [0.67]	35.80 [1.41]
07	11.09 [0.44]	14.12-14.31 [0.55-0.56]	18.71 [0.74]	37.30 [1.47]
08	12.70 [0.50]	15.72-15.91 [0.62-0.63]	20.32 [0.80]	39.10 [1.54]
10	15.87 [0.62]	18.84-19.11 [0.74-0.75]	23.49 [0.92]	41.40 [1.63]
12	19.05 [0.75]	22.02-22.28 [0.87-0.88]	26.67 [1.05]	45.50 [1.79]
14	22.23 [0.88]	25.17-25.46 [0.99-1.00]	29.84 [1.17]	48.80 [1.92]
16	25.40 [1.00]	28.34-28.63 [1.12-1.13]	33.02 [1.30]	51.80 [2.04]
18	28.57 [1.12]	31.52-31.81 [1.24-1.25]	36.19 [1.42]	54.90 [2.16]
20	31.75 [1.25]	34.69-34.98 [1.37-1.38]	39.37 [1.55]	58.20 [2.29]
22	34.93 [1.38]	37.79-38.15 [1.49-1.50]	42.55 [1.68]	66.80 [2.63]
24	38.10 [1.50]	40.97-41.33 [1.61-1.63]	45.72 [1.80]	70.10 [2.76]

Molded Part Selection Guide
(Tinel)

Tinel-Lock Entry Size	Standard K Parts			Low-Profile D Parts		
	Straight Part No.	90° Part No.	Cable OD (min.)	Straight Part No.	90° Part No.	Cable OD (Min.)
04	202K232	—	3.30 [0.13]	—	—	—
04	202W232	—	4.30 [0.19]	—	—	—
04	202K121	222K121	5.60 [0.22]	202D211	222D211	6.40 [0.25]
05, 06	202K132	222K132	5.90 [0.23]	202D221	222D221	7.40 [0.29]
07, 08	202K142	222K142	7.10 [0.28]	202D232	222D232	8.40 [0.33]
10, 12	202K153	222K152	8.40 [0.33]	202D242	222D242	9.70 [0.38]
14, 16	202K163	222K163	9.90 [0.39]	202D253	222D253	10.50 [0.41]
18, 20, 22	202K174	222K174	15.70 [0.62]	202D263	222D263	12.20 [0.48]
24	202K185	222K185	16.80 [0.66]	—	—	—

Uniboot Parts

Tinel-Lock Entry Size	Part No.	Cable OD (min.)
04	202C611	4.8 [0.19]
05, 06, 07	202C621	8.1 [0.32]
08, 10, 12	202C632	12.7 [0.50]
12, 14, 16	202C642	17.5 [0.69]
16, 18, 20, 22	202C653	22.4 [0.88]

Braided Adapters

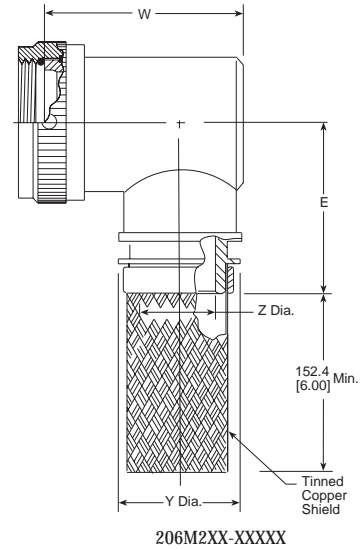
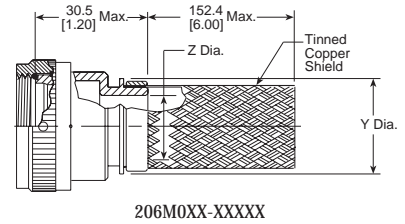
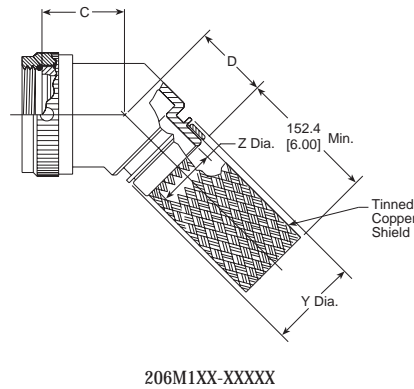

Table of Dimensions

Order No.	Shell Size	Max. Entry Size, Type 1*	Thread	Dimensions		
				C Max.	D Max.	E Max.
08	8	04	.438-28 UNEF	21.6 [0.85]	23.1 [0.91]	29.0 [1.14]
10	10	06	.562-24 UNEF	22.4 [0.88]	23.9 [0.94]	30.5 [1.20]
12	12	08	.688-24 UNEF	23.1 [0.91]	24.6 [0.97]	32.3 [1.27]
14	14	10	.812-20 UNEF	23.4 [0.92]	24.9 [0.98]	33.5 [1.32]
16	16	12	.938-20 UNEF	24.1 [0.95]	25.7 [1.01]	34.8 [1.37]
18	18	12	1.062-18 UNEF	24.4 [0.96]	25.9 [1.02]	36.3 [1.43]
20	20	14	1.188-18 UNEF	25.1 [0.99]	26.7 [1.05]	38.1 [1.50]
22	22	16	1.312-18 UNEF	25.7 [1.01]	27.4 [1.08]	39.6 [1.56]
24	24	18	1.438-18 UNEF	26.2 [1.03]	27.7 [1.09]	40.9 [1.61]

*For larger than maximum type 1 entry sizes, a two-piece adapter will be supplied. Contact Tyco Electronics for information.

Entry Size Dimensions

Entry Size	Dimensions		
	Z +0.25-0.5	Y Dia.	W Max.
04	6.35 [0.25]	13.97 [0.55]	31.0 [1.22]
05	7.92 [0.31]	15.54 [0.61]	32.8 [1.29]
06	9.52 [0.37]	17.14 [0.67]	34.3 [1.35]
07	11.09 [0.44]	18.71 [0.74]	35.8 [1.41]
08	12.70 [0.50]	20.32 [0.80]	37.3 [1.47]
10	15.87 [0.62]	23.49 [0.92]	40.6 [1.60]
12	19.05 [0.75]	26.67 [1.05]	43.7 [1.72]
14	22.23 [0.88]	29.84 [1.17]	47.0 [1.85]
16	25.40 [1.00]	33.02 [1.30]	50.0 [1.97]
18	28.57 [1.12]	36.19 [1.42]	53.3 [2.10]

Available in:	Americas	Europe	Asia Pacific
	■	■	■

Solid Adapters

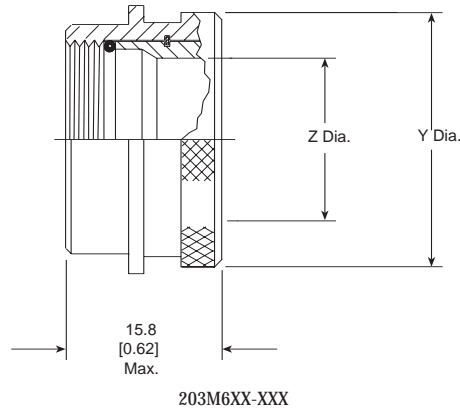

Table of Dimensions

Order Number	Shell Size	Thread	Dimensions	
			Y +0.000-0.030 (+0.00) (-0.76) Dia.	Z Min.
08	8	.438-28 UNEF	17.88 [0.704]	6.63 [0.26]
10	10	.562-24 UNEF	21.06 [0.829]	9.27 [0.36]
12	12	.688-24 UNEF	24.23 [0.954]	12.98 [0.51]
14	14	.812-20 UNEF	27.41 [1.079]	15.37 [0.61]
16	16	.938-20 UNEF	31.85 [1.254]	18.54 [0.73]
18	18	1.062-18 UNEF	33.03 [1.316]	20.90 [0.82]
20	20	1.188-18 UNEF	36.63 [1.442]	24.10 [0.95]
22	22	1.312-18 UNEF	39.78 [1.566]	27.28 [1.07]
24	24	1.438-18 UNEF	42.98 [1.692]	29.67 [1.17]

Molded Part Selection Guide (Solid)

Order No.	Standard K Parts			Low-Profile D Parts		
	Straight Part No.	90° Part No.	Cable OD (Min.)	Straight Part No.	90° Part No.	Cable OD (Min.)
08	202K132	222K132	5.9 [0.23]	202D221	222D221	7.4 [0.29]
10	202K142	222K142	7.1 [0.28]	202D232	222D232	8.4 [0.33]
12, 14	202K153	222K152	8.4 [0.33]	202D242	222D242	9.7 [0.38]
16, 18	202K163	222K163	9.9 [0.39]	202D253	222D253	10.5 [0.41]
20, 22, 24	202K174	222K174	15.7 [0.62]	202D263	222D263	12.2 [0.48]

Uniboot Parts

Order No.	Part No.	Cable OD (Min.)
08	202C621	8.1 [0.32]
10	202C632	12.7 [0.50]
12, 14	202C642	17.5 [0.69]
16, 18, 20, 22, 24	202C653	22.4 [0.88]

Available in:	Americas	Europe	Asia Pacific
	■	■	■

Spin-Coupling Adapters

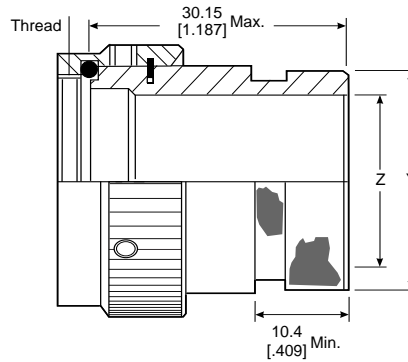

203M9XX-XXX

Table of Dimensions

Order No.	Shell Size	Thread	Dimensions	
			Y +0.00-0.76 Dia.	Z Min.
08	8	.438-28 UNEF	13.54 [0.53]	6.63 [0.26]
10	10	.562-24 UNEF	15.37 [0.61]	9.27 [0.36]
12	12	.688-24 UNEF	19.66 [0.77]	12.98 [0.51]
14	14	.812-20 UNEF	21.29 [0.84]	15.37 [0.61]
16	16	.938-20 UNEF	24.46 [0.96]	18.54 [0.73]
18	18	1.062-18 UNEF	26.47 [1.04]	20.90 [0.82]
20	20	1.188-18 UNEF	30.91 [1.22]	24.10 [0.95]
22	22	1.312-18 UNEF	34.42 [1.36]	27.28 [1.07]
24	24	1.438-18 UNEF	36.65 [1.44]	29.67 [1.17]

Molded Part Selection Guide (Spin-Coupling)

Order No.	Standard K Parts			Low-profile D Parts		
	Straight Part No.	90° Part No.	Cable OD (Min.)	Straight Part No.	90° Part No.	Cable OD (Min.)
08	202W232	—	4.3 [0.19]	—	—	—
08	202K121	222K121	5.6 [0.22]	202D211	222D211	6.4 [0.25]
10	202K132	222K132	5.9 [0.23]	202D221	222D221	7.4 [0.29]
12, 14	202K142	222K142	7.1 [0.28]	202D232	222D232	8.4 [0.33]
16, 18	202K153	222K152	8.4 [0.33]	202D242	222D242	9.7 [0.38]
20, 22	202K163	222K163	9.9 [0.39]	202D253	222D253	10.5 [0.41]
24	202K174	222K174	15.7 [0.62]	202D263	222D263	12.2 [0.48]

Uniboot Parts

Order No.	Part No.	Cable OD (Min.)
08	202C611	4.8 [0.19]
10, 12	202C621	8.1 [0.32]
14, 16	202C632	12.7 [0.50]
18, 20	202C642	17.5 [0.69]
22, 24	202C653	22.4 [0.88]

Available in:	Americas	Europe	Asia Pacific
	■	■	■

Tinel-Lock Adapters

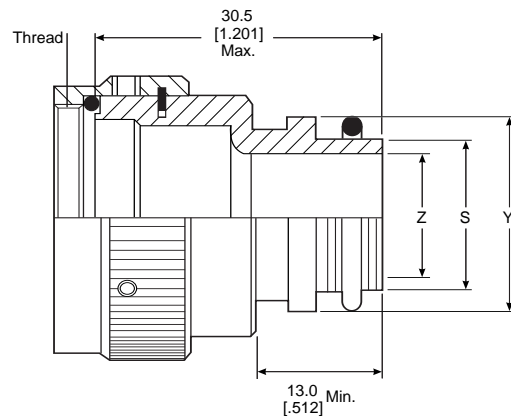

TXR21XX00-XXXX XX

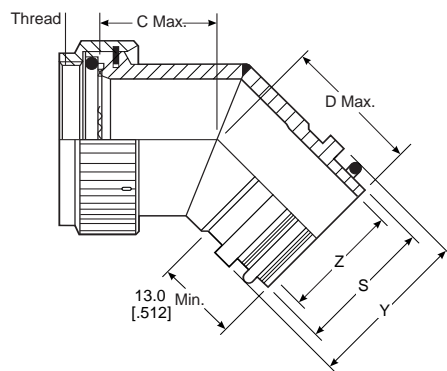

TXR21XX45-XXXXXX

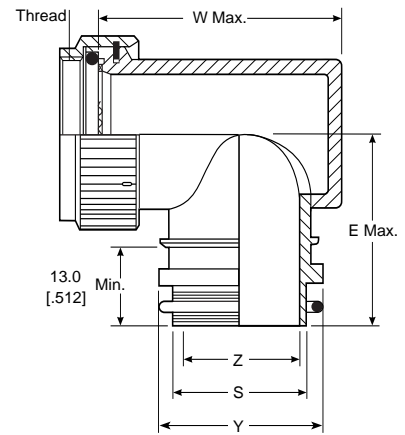

TXR21XX90-XXXXXX

Available in:	Americas	Europe	Asia Pacific
	■	■	■

Tinel-Lock Adapters
(continued)

Table of Dimensions

Order No.	Shell Size	Max. Entry Size, Type 1*	Thread	Dimensions		
				C Max.	D Max.	E Max.
08	8	04	.438-28 UNEF	21.6 [0.85]	23.1 [0.91]	29.0 [1.14]
10	10	06	.562-24 UNEF	22.4 [0.88]	23.9 [0.94]	30.5 [1.20]
12	12	08	.688-24 UNEF	23.1 [0.91]	24.6 [0.97]	32.3 [1.27]
14	14	10	.812-20 UNEF	23.4 [0.92]	24.9 [0.98]	33.5 [1.32]
16	16	12	.938-20 UNEF	24.1 [0.95]	25.7 [1.01]	34.8 [1.37]
18	18	12	1.062-18 UNEF	24.4 [0.96]	25.9 [1.02]	36.3 [1.43]
20	20	14	1.188-18 UNEF	25.1 [0.99]	26.7 [1.05]	38.1 [1.50]
22	22	16	1.312-18 UNEF	25.7 [1.01]	27.4 [1.08]	39.6 [1.56]
24	24	18	1.438-18 UNEF	26.2 [1.03]	27.7 [1.09]	40.9 [1.61]

*For larger than maximum type 1 entry sizes, a two-piece adapter will be supplied. Contact Tyco Electronics for information.

Entry Size Dimensions

Entry Size	Dimensions			
	Z +0.25-0.5	S Diameter (Min.-Max.)	Y Dia.	W Max.
04	6.35 [0.25]	9.39-9.56 [0.37-0.38]	13.97 [0.55]	31.0 [1.22]
05	7.92 [0.31]	10.97-11.13 [0.43-0.44]	15.54 [0.61]	32.8 [1.29]
06	9.52 [0.37]	12.57-12.73 [0.49-0.50]	17.14 [0.67]	34.3 [1.35]
07	11.09 [0.44]	14.12-14.31 [0.55-0.56]	18.71 [0.74]	35.8 [1.41]
08	12.7 [0.50]	15.72-15.91 [0.62-0.63]	20.32 [0.80]	37.3 [1.47]
10	15.87 [0.62]	18.84-19.11 [0.74-0.75]	23.49 [0.92]	40.6 [1.60]
12	19.05 [0.75]	22.02-22.28 [0.87-0.88]	26.67 [1.05]	43.7 [1.72]
14	22.23 [0.88]	25.17-25.46 [0.99-1.00]	29.84 [1.17]	47.0 [1.85]
16	25.4 [1.00]	28.34-28.63 [1.12-1.13]	33.02 [1.30]	50.0 [1.97]
18	28.57 [1.12]	31.52-31.81 [1.24-1.25]	36.19 [1.42]	53.3 [2.10]

Molded Part Selection Guide
(Tinel)

Tinel-Lock Entry Size	Standard K Parts			Low-profile D Parts		
	Straight Part No.	90° Part No.	Cable OD (Min.)	Straight Part No.	90° Part No.	Cable OD (Min.)
04	202K232	—	3.3 [0.1]	—	—	—
04	202W232	—	4.3 [0.2]	—	—	—
04	202K121	222K121	5.6 [0.2]	202D211	222D211	6.4 [0.3]
05, 06	202K132	222K132	5.9 [0.2]	202D221	222D221	7.4 [0.3]
07, 08	202K142	222K142	7.1 [0.3]	202D232	222D232	8.4 [0.3]
10, 12	202K153	222K152	8.4 [0.3]	202D242	222D242	9.7 [0.4]
14, 16	202K163	222K163	9.9 [0.4]	202D253	222D253	10.5 [0.4]
18, 20, 22	202K174	222K174	15.7 [0.6]	202D263	222D263	12.2 [0.5]
24	202K185	222K185	16.8 [0.7]	—	—	—

Uniboot Parts

Tinel-Lock Entry Size	Part No.	Cable OD (Min.)
04	202C611	4.8 [0.19]
05, 06, 07	202C621	8.1 [0.32]
08, 10, 12	202C632	12.7 [0.50]
12, 14, 16	202C642	17.5 [0.69]
16, 18, 20, 22	202C653	22.4 [0.88]
24	202C663	22.9 [0.90]

CRES-Lock Adapters (USA)
BND Adapters (Europe)

Code 21 Band Strap
Adapter

Notes:

1. This product is designed to terminate a braided cable shield by means of a band strap and a heat shrinkable lipped boot to a connector.
2. See CH00-0250-016 for ordering information, modifications and additional dimensions.
3. See drawing BND-XX25S for band strap dimensions and information.
4. Adapter to be permanently marked with code identification number and full part number (e.g. 06090-BND21AB00-1812). Band strap shall bear no part marking.
5. All entry sizes are shown in Table II. Maximum entry sizes are as shown in Table I. For larger entry sizes than the maximum, a Type II adapter may be supplied. See CH00-0250-016 for further details.
6. Adapter mates to: MIL-C-26482 Series I, MS3110, MS3116, MS3120 and MS3126 Class E and F Connectors.
7. Anti-rotational set screw, 3 threaded holes 120° ± 5° apart, single mating set screw supplied: AN565DC4H2. Not required for Type II adapters.

For additional codes available, contact Tyco Electronics.

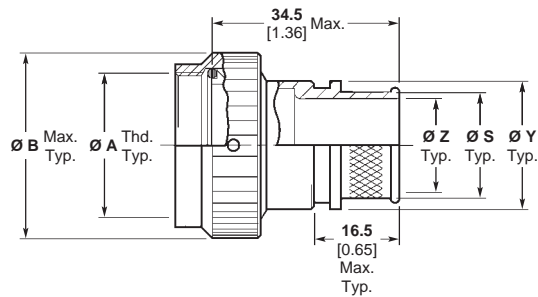
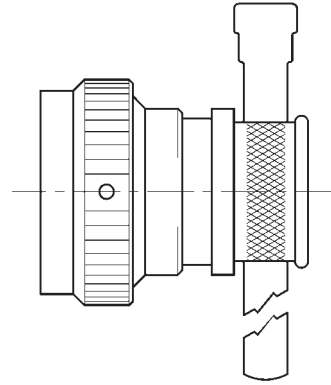

Straight Adapter
Code 00

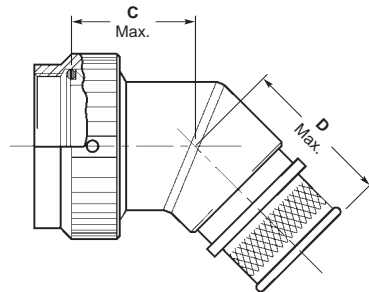

45° Adapter
Code 45

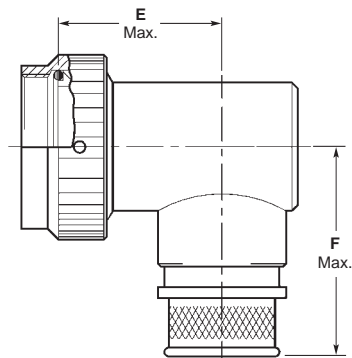

90° Adapter
Code 90

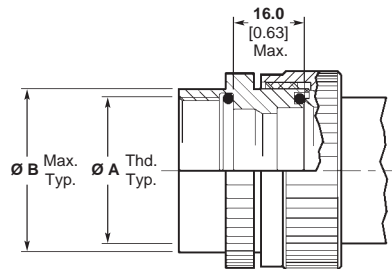

Type II Modification
(See Note 5)

Available in:	Americas	Europe	Asia Pacific
	■	■	■

CRES-Lock Adapters (USA)
BND Adapters (Europe)
(continued)

Code 21 Band Strap
Adapter (Continued)

Code 21 MIL-C-26482 Series 1 (Continued)

Table I

Order Number	Shell Size ²	Entry Size Max. Type I ¹	Ø A Unified Thread UNEF Class 2B	Ø B Max.	C Max.	D Max.	F Max.
08	08	04	0.4375-28	18.3 0.72	21.6 0.85	27.2 1.07	33.0 1.30
10	10	06	0.5625-24	21.6 0.85	22.4 0.88	27.9 1.10	34.5 1.36
12	12	08	0.6875-24	24.9 0.98	23.1 0.91	28.7 1.13	36.3 1.43
14	14	10	0.8125-20	28.2 1.11	23.4 0.92	29.0 1.14	37.6 1.48
16	16	12	0.9375-20	31.2 1.23	24.1 0.95	29.7 1.17	38.9 1.53
18	18	13	1.0625-18	34.5 1.36	24.4 0.96	30.0 1.18	40.4 1.59
20	20	15	1.1875-18	37.6 1.48	25.1 0.99	30.7 1.21	42.2 1.66
22	22	16	1.3125-18	40.6 1.60	25.7 1.01	31.5 1.24	43.7 1.72
24	24	18	1.4375-18	43.2 1.70	26.2 1.03	31.8 1.25	45.0 1.77

1. All entry sizes are shown in Table II. Maximum entry sizes are as shown in Table I. For larger entry sizes than the maximum, a Type II adapter may be supplied. See CH00-0250-016 for further details.
2. Adapter mates to: MIL-C-26482 Series I, MS3110, MS3116, MS3120 and MS3126 Class E and F Connectors.

Table II

Entry Size	Ø Z +0.25/-0.50 [+0.010/-0.020]	Ø S ±0.51 [±0.020]	Ø Y ±0.38 [±0.015]	E Max.
03	4.75 0.188	7.92 0.312	11.10 0.438	19.0 0.75
04	6.35 0.250	9.52 0.375	12.70 0.500	19.8 0.78
05	7.92 0.312	11.12 0.438	14.30 0.563	20.1 0.79
06	9.52 0.375	12.70 0.500	15.88 0.625	21.1 0.83
07	11.12 0.438	14.30 0.562	17.50 0.689	21.6 0.85
08	12.70 0.500	15.88 0.625	19.05 0.750	22.6 0.89
09	14.30 0.562	17.50 0.688	20.65 0.813	23.6 0.93
10	15.88 0.625	19.05 0.750	22.23 0.875	24.4 0.96
11	17.50 0.688	20.65 0.812	23.80 0.938	24.9 0.98
12	19.05 0.750	22.23 0.875	25.40 1.000	25.9 1.02
13	20.65 0.812	23.83 0.938	27.00 1.063	26.7 1.05
14	22.23 0.875	25.40 1.000	30.16 1.189	27.4 1.08

Table II (Continued)

Entry Size	Ø Z +0.25/-0.50 [+0.010/-0.020]	Ø S ±0.51 [±0.020]	Ø Y ±0.38 [±0.015]	E Max.
15	23.83 0.938	27.00 1.062	31.75 1.250	28.2 1.11
16	25.40 1.000	28.58 1.125	33.34 1.313	29.0 1.14
18	28.58 1.125	31.75 1.250	36.51 1.438	30.5 1.20
20	31.75 1.250	34.90 1.375	39.69 1.563	N/A
22	34.90 1.375	38.10 1.500	42.86 1.688	N/A
24	38.10 1.500	41.28 1.625	46.83 1.844	N/A
26	41.28 1.625	44.45 1.750	49.61 1.953	N/A
28	44.45 1.750	47.63 1.875	52.78 2.078	N/A
30	47.65 1.875	50.80 2.000	56.36 2.219	N/A
32	50.80 2.000	54.00 2.125	59.53 2.344	N/A
34	54.00 2.125	57.15 2.250	62.71 2.469	N/A

Braided Adapters

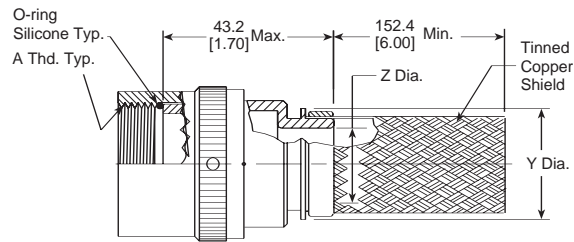

207M3XX-XXXX

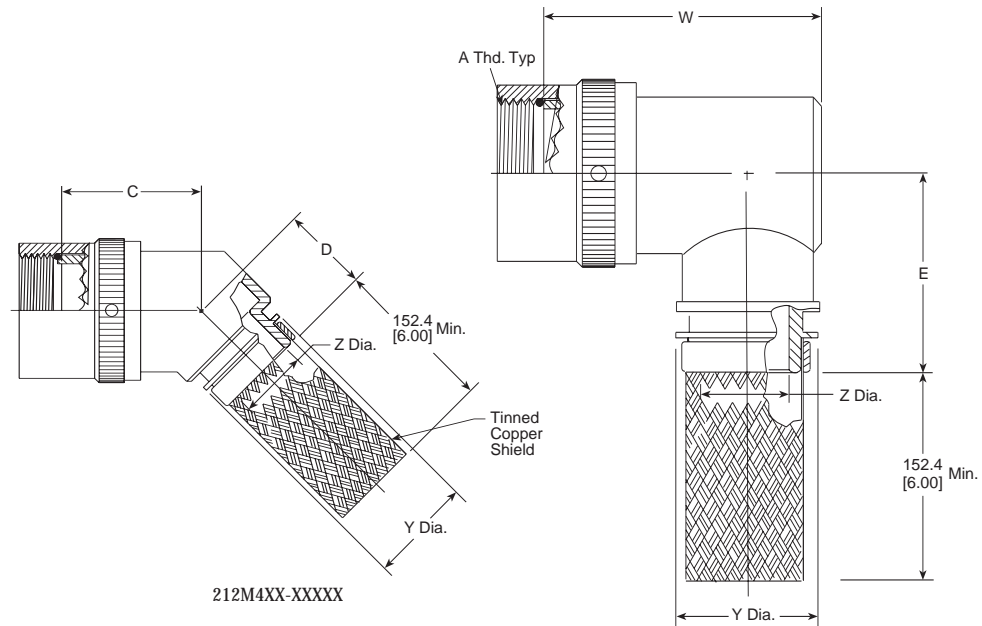

212M4XX-XXXX

212M5XX-XXXX

Available in:	Americas	Europe	Asia Pacific
	■	■	■

Table of Dimensions

Order No.	Shell Size	Max. Entry Size, Type 1*	A Left Hand Thd. Class 2B	Dimensions		
				C Max.	D Max.	E Max
12	12	08	.750-20 UNEF	29.0 [1.14]	25.4 [1.00]	33.5 [1.32]
14	14	10	.875-20 UNEF	29.7 [1.17]	25.9 [1.02]	35.3 [1.39]
16	16	12	1.000-20 UNEF	30.0 [1.18]	26.2 [1.03]	37.1 [1.46]
18	18	14	1.125-18 UNEF	30.7 [1.21]	26.9 [1.06]	38.6 [1.52]
20	20	16	1.250-18 UNEF	31.2 [1.23]	27.7 [1.09]	40.1 [1.58]
22	22	18	1.375-18 UNEF	32.0 [1.26]	28.2 [1.11]	41.7 [1.64]
24	24	22	1.625-18 UNEF	33.5 [1.32]	30.0 [1.18]	46.5 [1.83]
28	28	24	1.875-16 UN	34.8 [1.37]	31.2 [1.23]	49.8 [1.96]
32	32	28	2.062-16 UNS	36.3 [1.43]	32.5 [1.28]	52.8 [2.08]
36	36	28	2.312-16 UNS	37.6 [1.48]	33.8 [1.33]	56.1 [2.21]
40	40	28	2.625-16 UN	38.9 [1.53]	35.3 [1.39]	58.9 [2.32]

*For larger than maximum type 1 entry sizes, a two-piece adapter will be supplied. Contact Tyco Electronics for information.

Entry Size Dimensions

Entry Size	Dimensions		
	Z ± 0.20 (± 0.51)	Y Dia. Min.	W Max.
03	4.75 [.187]	9.98 [.393]	39.6 [1.56]
04	6.35 [.250]	11.58 [.456]	39.6 [1.56]
05	7.92 [.312]	13.08 [.515]	42.9 [1.69]
06	9.53 [.375]	14.76 [.581]	42.9 [1.69]
07	11.13 [.438]	16.33 [.643]	46.0 [1.81]
08	12.70 [.500]	17.91 [.705]	—
09	14.27 [.562]	17.91 [.705]	49.3 [1.94]
10	15.88 [.625]	21.11 [.831]	49.3 [1.94]
11	17.48 [.688]	22.68 [.893]	52.3 [2.06]
12	19.05 [.750]	24.21 [.953]	52.3 [2.06]
13	20.62 [.812]	24.21 [.953]	55.6 [2.19]
14	22.23 [.875]	27.46 [1.081]	55.6 [2.19]
15	23.83 [.938]	29.03 [1.143]	59.9 [2.36]
16	25.40 [1.000]	30.61 [1.205]	59.9 [2.36]
18	28.58 [1.125]	35.08 [1.381]	69.6 [2.74]
20	31.75 [1.250]	38.25 [1.506]	72.6 [2.86]
22	34.93 [1.375]	41.43 [1.631]	75.9 [2.99]
24	38.10 [1.500]	44.60 [1.756]	79.0 [3.11]
28	44.45 [1.750]	50.90 [2.004]	85.3 [3.36]

Spin-Coupling Adapters

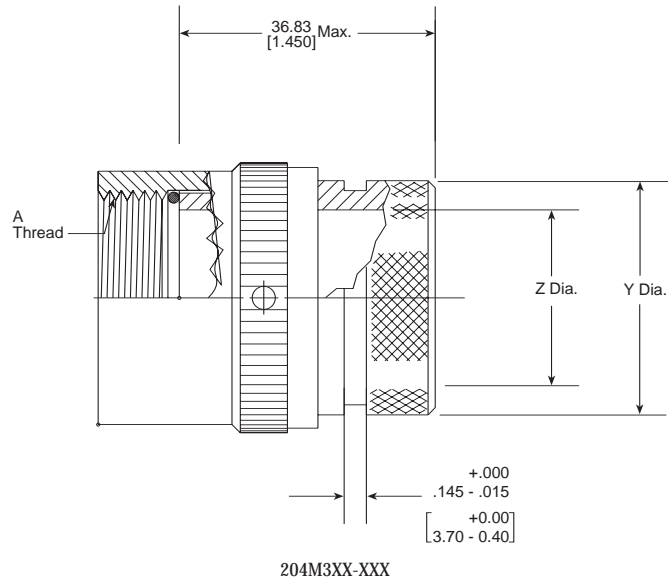

Table of Dimensions

Base Part Number	Shell Size	A L.H. Thread Class 2B	Dimensions	
			Y ± .020 (±0.51)	Z Min.
12	12	.750-20 UNEF	20.24 [.797]	12.47 [.491]
14	14	.875-20 UNEF	23.44 [.923]	14.35 [.565]
16	16	1.000-20 UNEF	26.42 [1.040]	17.53 [.690]
18	18	1.125-18 UNEF	31.17 [1.227]	18.19 [.716]
20	20	1.250-18 UNEF	34.49 [1.358]	21.72 [.855]
22	22	1.375-18 UNEF	37.21 [1.465]	25.02 [.985]
24	24	1.625-18 UNEF	42.82 [1.686]	30.48 [1.200]
28	28	1.875-16 UN	50.06 [1.971]	36.58 [1.440]
32	32	2.062-16 UNS	55.35 [2.179]	40.77 [1.605]
36	36	2.312-16 UNEF	61.01 [2.402]	52.96 [2.085]
40	40	2.625-16 UNS	67.46 [2.656]	57.15 [2.250]
44	44	2.875-16 UNS	70.66 [2.782]	62.46 [2.549]

*For larger than maximum type 1 entry sizes, a two-piece adapter will be supplied. Contact Tyco Electronics for information.

Molded Part Size Selection Guide (Spin-Coupling)

Order No.	Standard K Parts			Low-profile D Parts		
	Straight Part No.	90° Part No.	Cable OD (Min.)	Straight Part No.	90° Part No.	Cable OD (Min.)
12	202K142	222K142	7.1 [0.28]	202D232	222D232	8.4 [0.33]
14, 16	202K153	222K152	8.4 [0.33]	202D242	222D242	9.7 [0.38]
18, 20	202K163	222K163	9.9 [0.39]	202D253	222D253	10.5 [0.41]
22, 24	202K174	222K174	15.7 [0.62]	202D263	222D263	12.2 [0.48]
26, 32, 36	202K185	222K185	16.8 [0.66]	—	—	—

Uniboost Parts

Order No.	Part No.	Cable OD (Min.)
12	202C632	12.7 [0.50]
14, 16	202C642	17.5 [0.69]
18, 20, 22, 24	202C653	22.4 [0.88]

Available in:	Americas	Europe	Asia Pacific
	■	■	■

Tinel-Lock Adapters

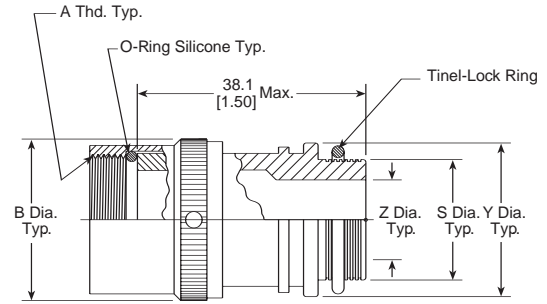

TXR32XX00-XXXXXX

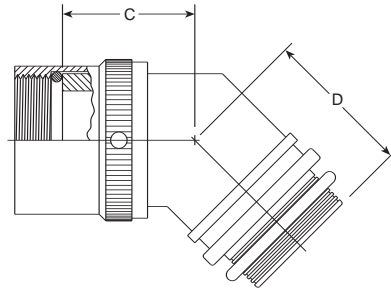

TXR32XX45-XXXXXX

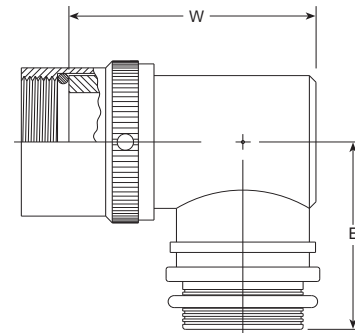

TXR32XX90-XXXXXX

Order No.	Shell Size	Max. Entry Size Type I	Dimensions							
			A Left Hand Thd Class 2B	C Max.	D Max.	E Max.	Z +.010 - .020	S Dia.	Y ±.015 (± 0.38)	W Max.
12	12	08	.750-20 UNEF	29.0 [1.14]	25.4 [1.00]	33.5 [1.32]	19.05 [.750]	22.28 [.877] 22.02 [.867]	26.67 [1.050]	52.3 [2.06]
14	14	10	.875-20 UNEF	29.7 [1.17]	25.9 [1.02]	35.3 [1.39]	22.23 [.875]	25.46 [1.002] 25.17 [.991]	29.84 [1.175]	55.6 [2.19]
16	16	12	1.000-20 UNEF	30.0 [1.18]	26.2 [1.03]	37.1 [1.46]	25.40 [1.000]	28.63 [1.127] 28.34 [1.116]	33.02 [1.300]	59.01 [2.36]
18	18	14	1.125-18 UNEF	30.7 [1.21]	26.9 [1.06]	38.6 [1.52]	28.57 [1.125]	31.81 [1.252] 31.52 [1.241]	36.19 [1.425]	69.6 [2.74]
20	20	16	1.250-18 UNEF	31.2 [1.23]	27.7 [1.09]	40.1 [1.58]	31.75 [1.250]	34.98 [1.377] 34.69 [1.366]	39.37 [1.550]	72.6 [2.86]
22	22	18	1.375-18 UNEF	32.0 [1.26]	28.2 [1.11]	41.7 [1.64]	34.93 [1.375]	38.15 [1.502] 37.79 [1.488]	42.55 [1.675]	75.9 [2.99]
24	24	22	1.625-18 UNEF	33.5 [1.32]	30.0 [1.18]	46.5 [1.83]	38.10 [1.500]	41.33 [1.627] 40.97 [1.613]	45.72 [1.800]	79.0 [3.11]
28	28	24	1.875-16 UN	34.8 [1.37]	31.2 [1.23]	49.8 [1.96]	—	—	—	—
32	32	24	2.062-16 UNS	36.3 [1.43]	32.5 [1.28]	52.8 [2.08]	—	—	—	—
36	36	24	2.312-16 UNS	37.6 [1.48]	33.8 [1.33]	56.1 [2.21]	—	—	—	—
40	40	24	2.625-16 UN	38.9 [1.53]	35.3 [1.39]	58.9 [2.32]	—	—	—	—

**For larger than maximum type 1 entry sizes, a two-piece adapter will be supplied. Contact Tyco Electronics for information.

Available in:	Americas	Europe	Asia Pacific
	■	■	■

CRES-Lock Adapters (USA)
BND Adapters (Europe)

Code 32 Band Strap
Adapter

Notes:

1. This product is designed to terminate a braided cable shield by means of a band strap and a heat shrinkable lipped boot to a connector.
2. See CH00-0250-016 for ordering information, modifications and additional dimensions.
3. See drawing BND-XX25S for band strap dimensions and information.
4. Adapter to be permanently marked with code identification number and full part number (e.g. 06090-BND32AB00-1812). Band strap shall bear no part marking.
5. All entry sizes are shown in Table II. Maximum entry sizes are as shown in Table I. For larger entry sizes than the maximum, a Type II adapter may be supplied. See CH00-0250-016 for further details.
6. Adapter mates to: MIL-C-22992, Class C and R, MS17343, 44, 45 and 47 Connectors.
7. Anti-rotational set screw, 3 threaded holes $120^\circ \pm 5^\circ$ apart, single mating set screw supplied: AN565DC4H2. Not required for Type II adapters.

For additional codes available, contact Tyco Electronics.

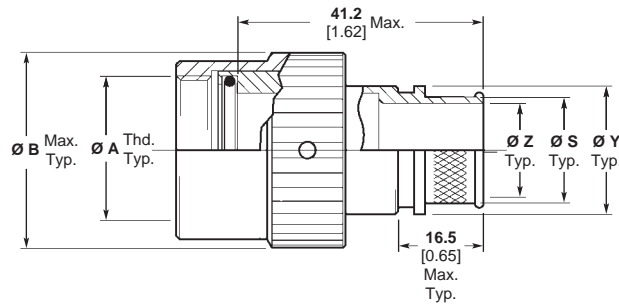
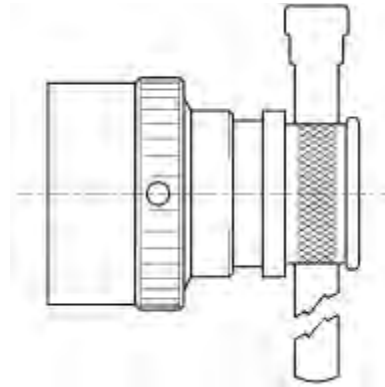

Straight Adapter
Code 00

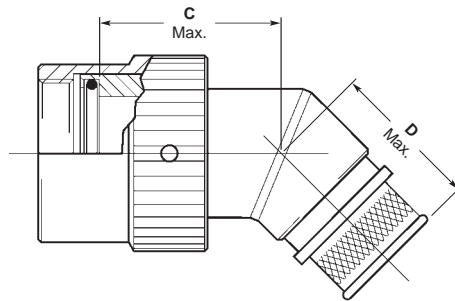

45° Adapter
Code 45

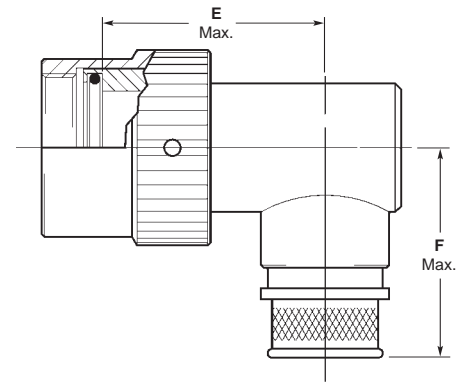

90° Adapter
Code 90

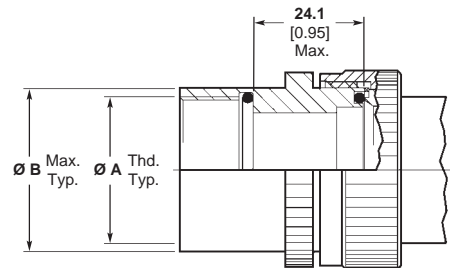

Type II Modification
(See Note 5)

Available in:	Americas	Europe	Asia Pacific
	■	■	■

CRES-Lock Adapters (USA)
BND Adapters (Europe)
(continued)

Code 32 Band Strap
Adapter (Continued)

Code 32 MIL-C-22992 (Continued)

Table I

Order Number	Shell Size ²	Entry Size Max. Type I ¹	Ø A Unified Thread Class 2B	Ø B Max.	C Max.	D Max.	F Max.
12	12	08	0.7500-20 UNEF	27.2 1.07	29.0 1.14	28.4 1.12	36.6 1.44
14	14	10	0.8750-20 UNEF	30.2 1.19	29.7 1.17	28.9 1.14	38.4 1.51
16	16	12	1.0000-20 UNEF	33.5 1.32	30.0 1.18	29.2 1.15	40.1 1.58
18	18	14	1.1250-18 UNEF	36.6 1.44	30.7 1.21	30.0 1.18	41.7 1.64
20	20	16	1.2500-18 UNEF	39.9 1.57	31.2 1.23	30.7 1.21	43.2 1.70
22	22	18	1.3750-18 UNEF	42.9 1.69	32.0 1.26	31.2 1.23	44.7 1.76
24	24	22	1.6250-18 UNEF	52.6 2.07	33.5 1.32	33.0 1.30	49.5 1.95
28	28	26	1.8750-16 UN	58.9 2.32	34.8 1.37	34.3 1.35	52.8 2.08
32	32	30	2.0625-16 UNS	65.3 2.57	36.3 1.43	35.6 1.40	55.9 2.20
36	36	34	2.3125-16 UNS	71.6 2.82	37.6 1.48	36.8 1.45	59.2 2.33
40	40	34	2.6250-16 UN	78.0 3.07	38.9 1.53	38.4 1.51	62.0 2.44

1. All entry sizes are shown in Table II. Maximum entry sizes are as shown in Table I. For larger entry sizes than the maximum, a Type II adapter may be supplied. See CH00-0250-016 for further details.
2. Adapter mates to: MIL-C-22992, Class C and R, MS17343, 44, 45 and 47 Connectors.

Table II

Entry Size	Ø Z +0.25/-0.50 [+0.010/-0.020]	Ø S ±0.51 [±0.020]	Ø Y ±0.38 [±0.015]	E Max.
03	4.75 0.188	7.92 0.312	11.10 0.438	28.3 1.12
04	6.35 0.250	9.52 0.375	12.70 0.500	29.3 1.15
05	7.92 0.312	11.12 0.438	14.30 0.563	30.0 1.18
06	9.52 0.375	12.70 0.500	15.88 0.625	30.8 1.21
07	11.12 0.438	14.30 0.562	17.50 0.689	31.5 1.24
08	12.70 0.500	15.88 0.625	19.05 0.750	32.3 1.27
09	14.30 0.562	17.50 0.688	20.65 0.813	33.3 1.31
10	15.88 0.625	19.05 0.750	22.23 0.875	34.0 1.34
11	17.50 0.688	20.65 0.812	23.80 0.938	35.0 1.38
12	19.05 0.750	22.23 0.875	25.40 1.000	35.8 1.41
13	20.65 0.812	23.83 0.938	27.00 1.063	36.0 1.42
14	22.23 0.875	25.40 1.000	30.16 1.189	37.5 1.48

Table II (Continued)

Entry Size	Ø Z +0.25/-0.50 [+0.010/-0.020]	Ø S ±0.51 [±0.020]	Ø Y ±0.38 [±0.015]	E Max.
15	23.83 .0938	27.00 1.062	31.75 1.250	37.8 1.49
16	25.40 1.000	28.58 1.125	33.34 1.313	38.3 1.51
18	28.58 1.125	31.75 1.250	36.51 1.438	39.8 1.57
20	31.75 1.250	34.90 1.375	39.69 1.563	41.3 1.63
22	34.90 1.375	38.10 1.500	42.86 1.688	43.0 1.69
24	38.10 1.500	41.28 1.625	46.83 1.844	44.5 1.75
26	41.28 1.625	44.45 1.750	49.61 1.953	46.3 1.82
28	44.45 1.750	47.63 1.875	52.78 2.078	48.3 1.90
30	47.65 1.875	50.80 2.000	56.36 2.219	50.0 1.97
32	50.80 2.000	54.00 2.125	59.53 2.344	51.5 2.03
34	54.00 2.125	57.15 2.250	62.71 2.469	53.3 2.10

Braided Adapters

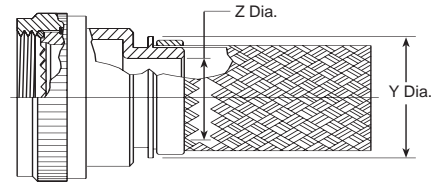

208M7XX-XXXXX

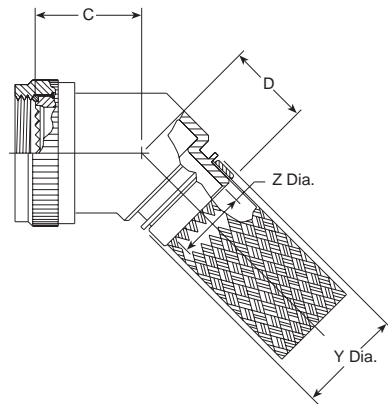

208M8XX-XXXXX

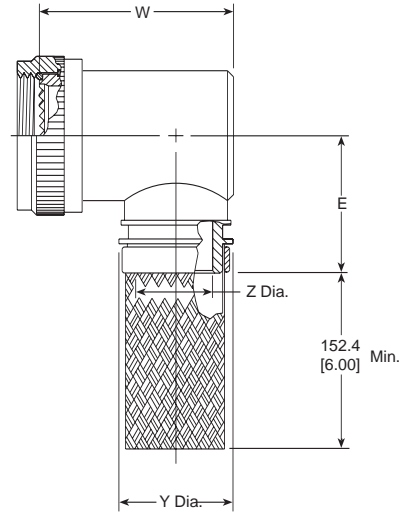

208M9XX-XXXXX

Table of Dimensions

Order No.	Shell Size Commercial	Military	Max. Entry* Size Type 1	Thread	Dimensions		
					C Max.	D Max.	E Max.
08	9	A	04	M12 x 1.0	20.8 [0.82]	22.6 [0.89]	29.2 [1.15]
10	11	B	07	M15 x 1.0	21.3 [0.84]	23.4 [0.92]	30.7 [1.21]
12	13	C	09	M18 x 1.0	22.1 [0.87]	24.1 [0.95]	32.5 [1.28]
14	15	D	10	M2 x 1.0	22.6 [0.89]	24.1 [0.95]	34.0 [1.34]
16	17	E	12	M25 x 1.0	23.4 [0.92]	24.9 [0.98]	35.6 [1.40]
18	19	F	14	M28 x 1.0	24.1 [0.95]	25.7 [1.01]	37.1 [1.46]
20	21	G	16	M31 x 1.0	24.6 [0.97]	26.4 [1.04]	38.9 [1.53]
22	23	H	18	M34 x 1.0	25.4 [1.00]	27.2 [1.07]	40.4 [1.59]
24	25	J	20	M37 x 1.0	25.9 [1.02]	27.2 [1.07]	42.4 [1.67]

*For larger than maximum type 1 entry sizes, a two-piece adapter will be supplied. Contact Tyco Electronics for information.

Available in:	Americas	Europe	Asia Pacific
	■	■	■

Braided Adapters
(continued)

Entry Size Dimensions

Entry Size	Dimensions		
	Z +0.25-0.5	Y Dia.	W Max.
04	6.35 [0.25]	13.97 [0.55]	31.2 [1.23]
05	7.92 [0.31]	15.54 [0.61]	32.8 [1.29]
06	9.52 [0.37]	17.14 [0.67]	34.3 [1.35]
07	11.09 [0.44]	18.71 [0.74]	36.1 [1.42]
08	12.7 [0.50]	20.32 [0.80]	37.6 [1.48]
10	15.87 [0.62]	23.49 [0.92]	40.6 [1.60]
12	19.05 [0.75]	26.67 [1.05]	43.9 [1.73]
14	22.23 [0.88]	29.84 [1.17]	47.0 [1.85]
16	25.4 [1.00]	33.02 [1.30]	50.8 [2.00]
18	28.57 [1.12]	36.19 [1.42]	54.1 [2.13]
20	31.75 [1.25]	39.37 [1.55]	57.21 [2.25]

Molded Part Selection Guide
(Braided)

Tinel-Lock Entry Size	Standard K Parts			Low-Profile D Parts		
	Straight Part No.	90° Part No.	Cable OD (Min.)	Straight Part No.	90° Part No.	Cable OD (Min.)
04	202K232	—	3.3 [0.1]	—	—	—
04	202W232	—	4.3 [0.2]	—	—	—
04	202K121	222K121	5.6 [0.2]	202D211	222D211	6.4 [0.3]
05, 06	202K132	222K132	5.9 [0.2]	202D221	222D221	7.4 [0.3]
07, 08	202K142	222K142	7.1 [0.3]	202D232	222D232	8.4 [0.3]
10, 12	202K153	222K152	8.4 [0.3]	202D242	222D242	9.7 [0.4]
14, 16	202K163	222K163	9.9 [0.4]	202D253	222D253	10.5 [0.4]
18, 20, 22	202K174	222K174	15.7 [0.6]	202D263	222D263	12.2 [0.5]
24	202K185	222K185	16.8 [0.7]	—	—	—

Uniboot Parts

Tinel-Lock Entry Size	Part No.	Cable OD (Min.)
04	202C611	4.8 [0.19]
05, 06, 07	202C621	8.1 [0.32]
08, 10, 12	202C632	12.7 [0.50]
12, 14, 16	202C642	17.5 [0.69]
16, 18, 20, 22	202C653	22.4 [0.88]
24	202C663	22.9 [0.90]

Solid Adapters

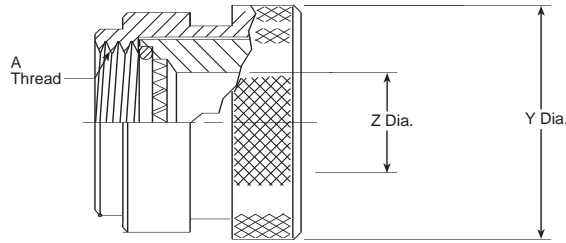

209M3XX-XXX

Table of Dimensions

Order No.	Shell Size Commercial	Military	A Thread	Dimensions	
				Y +.000- .030 (+0.00) (-0.76)	Z Dia. Min.
08	9	A	M12 x 1.0	18.26 [.719]	6.35 [.250]
10	11	B	M15 x 1.0	21.44 [.844]	9.52 [.375]
12	13	C	M18 x 1.0	24.61 [.969]	12.70 [.500]
14	15	D	M22 x 1.0	30.91 [1.217]	15.88 [.625]
16	17	E	M25 x 1.0	34.40 [1.354]	19.05 [.750]
18	19	F	M28 x 1.0	37.50 [1.476]	20.62 [.812]
20	21	G	M31 x 1.0	38.89 [1.531]	23.80 [.937]
22	23	H	M34 x 1.0	42.06 [1.656]	26.97 [1.062]
24	25	J	M37 x 1.0	45.24 [1.781]	30.18 [1.188]

Molded Part Selection Guide (Solid)

Order No.	Standard K Parts			Low-Profile D Parts		
	Straight Part No.	90° Part No.	Cable OD (Min.)	Straight Part No.	90° Part No.	Cable OD (Min.)
08	202K132	222K132	5.9 [0.23]	202D221	222D221	7.4 [0.29]
10	202K142	222K142	7.1 [0.28]	202D232	222D232	8.4 [0.33]
12, 14	202K153	222K152	8.4 [0.33]	202D242	222D242	9.7 [0.38]
16, 18	202K163	222K163	9.9 [0.39]	202D253	222D253	10.5 [0.41]
20, 22, 24	202K174	222K174	15.7 [0.62]	202D263	222D263	12.2 [0.48]

Uniboot Parts

Order No.	Part No.	Cable OD (Min.)
08	202C621	8.1 [0.32]
10	202C632	12.7 [0.50]
12, 14	202C642	17.5 [0.69]
16, 18, 20, 22	202C653	22.4 [0.88]

Available in:	Americas	Europe	Asia Pacific
	■	■	■

Spin-Coupling Adapters

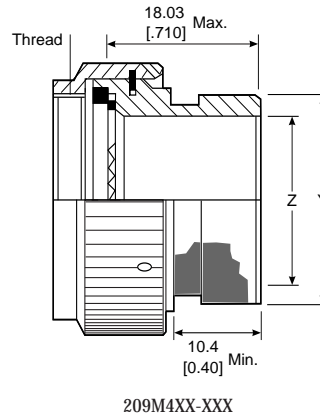

Table of Dimensions

Order No.	Shell Size Commercial	Military	Thread	Dimensions	
				Y Dia. Max.	Z Dia. Max.
08	9	A	M12 x 1.0	13.54 [0.53]	6.35 [0.25]
10	11	B	M15 x 1.0	15.37 [0.61]	9.52 [0.37]
12	13	C	M18 x 1.0	19.66 [0.77]	12.7 [0.50]
14	15	D	M22 x 1.0	21.29 [0.84]	15.75 [0.62]
16	17	E	M25 x 1.0	24.46 [0.96]	18.92 [0.74]
18	19	F	M28 x 1.0	26.47 [1.04]	20.62 [0.81]
20	21	G	M31 x 1.0	30.91 [1.22]	23.8 [0.94]
22	23	H	M34 x 1.0	34.42 [1.36]	26.97 [1.06]
24	25	J	M37 x 1.0	36.65 [1.44]	29.85 [1.18]

Molded Part Selection Guide (Spin-Coupling)

Order No.	Standard K Parts			Low-Profile D Parts		
	Straight Part No.	90° Part No.	Cable OD (Min.)	Straight Part No.	90° Part No.	Cable OD (Min.)
03, 08	202W232	—	4.3 [0.19]	—	—	—
03, 08	202K121	222K121	5.6 [0.22]	202D211	222D211	6.4 [0.25]
10, 11	202K132	222K132	5.9 [0.23]	202D221	222D221	7.4 [0.29]
12, 14	202K142	222K142	7.1 [0.28]	202D232	222D232	8.4 [0.33]
16, 18	202K153	222K152	8.4 [0.33]	202D242	222D242	9.7 [0.38]
20, 22	202K163	222K163	9.9 [0.39]	202D253	222D253	10.5 [0.41]
24, 28	202K174	222K174	15.7 [0.62]	202D263	222D263	12.2 [0.48]
32, 36	202K185	222K185	16.8 [0.66]	—	—	—

Uniboot Parts

Order No.	Part No.	Cable OD (Min.)
03, 08	202C611	4.8 [0.19]
10, 11, 12	202C621	8.1 [0.32]
14, 16	202C632	12.7 [0.50]
18, 20	202C642	17.5 [0.69]
22, 24	202C653	22.4 [0.88]

Available in:	Americas	Europe	Asia Pacific
	■	■	■

Tinel-Lock Adapters

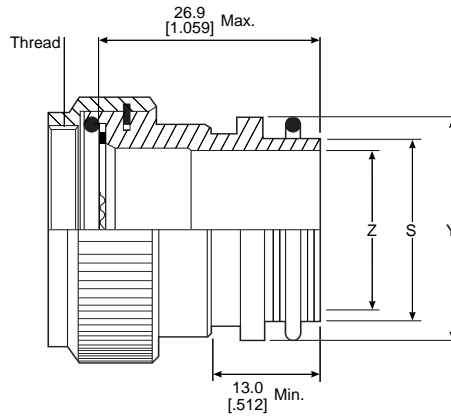

TXR40XX00-XXXXXX

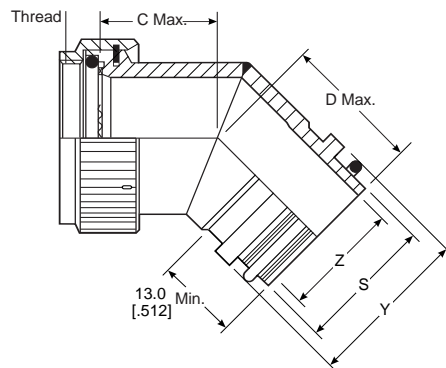

TXR40XX45-XXXXXX

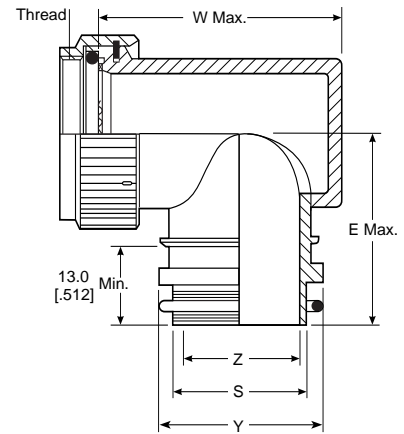

TXR40XX90-XXXXXX

Table of Dimensions

Order No.	Shell Size Commercial	Military	Max. Entry* Size Type 1	Thread	Dimensions		
					C Max.	D Max.	E Max.
08	9	A	04	M12 x 1.0	20.8 [0.82]	22.6 [0.89]	27.9 [1.10]
10	11	B	07	M15 x 1.0	21.3 [0.84]	23.4 [0.92]	30.5 [1.20]
12	13	C	08	M18 x 1.0	22.1 [0.87]	24.1 [0.95]	32.0 [1.26]
14	15	D	10	M2 x 1.0	22.6 [0.89]	24.1 [0.95]	34.0 [1.34]
16	17	E	12	M25 x 1.0	23.4 [0.92]	24.9 [0.98]	35.6 [1.40]
18	19	F	14	M28 x 1.0	24.1 [0.95]	25.7 [1.01]	36.8 [1.45]
20	21	G	16	M31 x 1.0	24.6 [0.97]	26.4 [1.04]	38.4 [1.51]
22	23	H	18	M34 x 1.0	25.4 [1.00]	27.2 [1.07]	39.9 [1.57]
24	25	J	20	M37 x 1.0	25.9 [1.02]	27.2 [1.07]	42.4 [1.67]

*For larger than maximum type 1 entry sizes, a two-piece adapter will be supplied. Contact Tyco Electronics for information.

Available in:	Americas	Europe	Asia Pacific
	■	■	■

Tinel-Lock Adapters
(continued)

Entry Size Dimensions

Entry Size	Dimensions			
	Z +0.25-0.5	S Diameter (Min.-Max.)	Y Dia.	W Max.
04	6.35 [0.25]	9.39-9.56 [0.37-0.38]	13.97 [0.55]	31.2 [1.23]
05	7.92 [0.31]	10.97-11.13 [0.43-0.44]	15.54 [0.61]	32.8 [1.29]
06	9.52 [0.37]	12.57-12.73 [0.49-0.50]	17.14 [0.67]	34.3 [1.35]
07	11.09 [0.44]	14.12-14.31 [0.55-0.56]	18.71 [0.74]	36.1 [1.42]
08	12.7 [0.50]	15.72-15.91 [0.62-0.63]	20.32 [0.80]	37.6 [1.48]
10	15.87 [0.62]	18.84-19.11 [0.74-0.75]	23.49 [0.92]	40.6 [1.60]
12	19.05 [0.75]	22.02-22.28 [0.87-0.88]	26.67 [1.05]	43.9 [1.73]
14	22.23 [0.88]	25.17-25.46 [0.99-1.00]	29.84 [1.17]	47.0 [1.85]
16	25.4 [1.00]	28.34-28.63 [1.12-1.13]	33.02 [1.30]	50.8 [2.00]
18	28.57 [1.12]	31.52-31.81 [1.24-1.25]	36.19 [1.42]	54.1 [2.13]
20	31.75 [1.25]	34.69-34.98 [1.37-1.38]	39.37 [1.55]	57.21 [2.25]

Molded Part Selection Guide
(Tinel)

Tinel-Lock Entry Size	Standard K Parts			Low-Profile D Parts		
	Straight Part No.	90° Part No.	Cable OD (Min.)	Straight Part No.	90° Part No.	Cable OD (Min.)
04	202K232	—	3.3 [0.1]	—	—	—
04	202W232	—	4.3 [0.2]	—	—	—
04	202K121	222K121	5.6 [0.2]	202D211	222D211	6.4 [0.3]
05, 06	202K132	222K132	5.9 [0.2]	202D221	222D221	7.4 [0.3]
07, 08	202K142	222K142	7.1 [0.3]	202D232	222D232	8.4 [0.3]
10, 12	202K153	222K152	8.4 [0.3]	202D242	222D242	9.7 [0.4]
14, 16	202K163	222K163	9.9 [0.4]	202D253	222D253	10.5 [0.4]
18, 20, 22	202K174	222K174	15.7 [0.6]	202D263	222D263	12.2 [0.5]
24	202K185	222K185	16.8 [0.7]	—	—	—

Uniboot Parts

Tinel-Lock Entry Size	Part No.	Cable OD (Min.)
04	202C611	4.8 [0.19]
05, 06, 07	202C621	8.1 [0.32]
08, 10, 12	202C632	12.7 [0.50]
12, 14, 16	202C642	17.5 [0.69]
16, 18, 20, 22	202C653	22.4 [0.88]
24	202C663	22.9 [0.90]

CRES-Lock Adapters (USA)
BND Adapters (Europe)

Code 40 Band Strap
Adapter

Notes:

1. This product is designed to terminate a braided cable shield by means of a band strap and a heat shrinkable lipped boot to a connector.
2. See CH00-0250-016 for ordering information, modifications and additional dimensions.
3. See drawing BND-XX25S for band strap dimensions and information.
4. Adapter to be permanently marked with code identification number and full part number (e.g. 06090-BND40AB00-1814). Band strap shall bear no part marking.
5. All entry sizes are shown in Table II. Maximum entry sizes are as shown in Table I. For larger entry sizes than the maximum, a Type II adapter may be supplied. See CH00-0250-016 for further details.
6. Adapter mates to: MIL-C-38999 Series III and IV, Class C, F, K and W, D38999/20, /24, /26, /40, /46 and /47 Connectors. When so mated it shall provide a water-tight seal meeting the requirements of MIL-C-85049, paragraph 3.5.7.
7. Coupling nut shall have 3 lock wire holes 120° apart.

For additional codes available, contact Tyco Electronics.

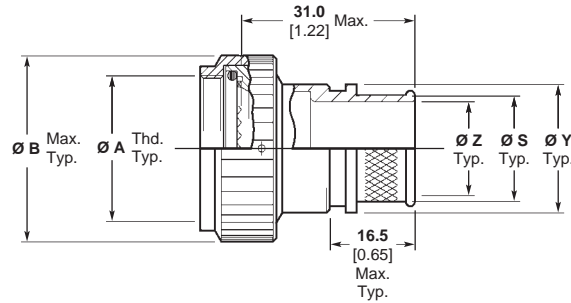
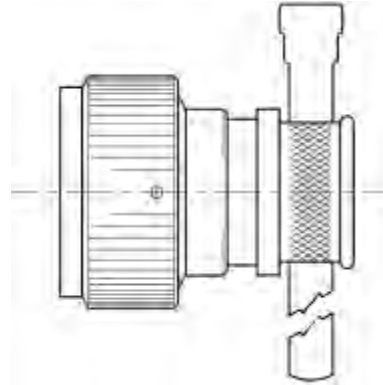

Straight Adapter
Code 00

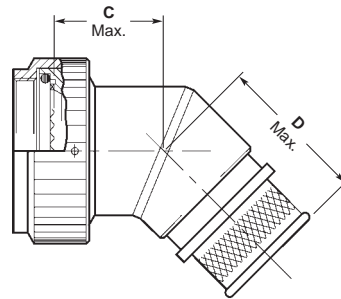

45° Adapter
Code 45

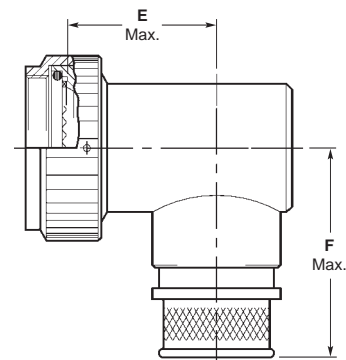

90° Adapter
Code 90

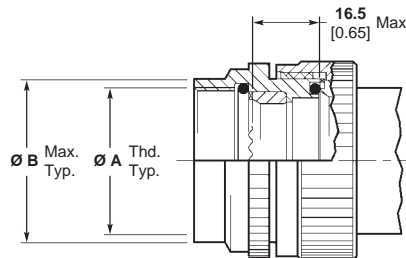

Type II Modification
(See Note 5)

Available in:	Americas	Europe	Asia Pacific
	■	■	■

CRES-Lock Adapters (USA)
BND Adapters (Europe)
(continued)

Code 40 Band Strap
Adapter (Continued)

Code 40 MIL-C-38999 Series III and IV (Continued)

Table I

Order Number	Shell Size ^e		Entry Size Max. Type I ^f	Ø A Metric Thread Class 2B	Ø B Max.	Ø B Max. ³	C Max.	D Max.	F Max.
	Com.	MIL							
8	9	A	04	M12 x 1.0	19.1 0.75	24.6 0.97	20.8 0.82	26.7 1.05	32.0 1.26
10	11	B	07	M15 x 1.0	21.6 0.85	27.0 1.06	21.3 0.84	27.4 1.08	34.5 1.36
12	13	C	09	M18 x 1.0	25.4 1.00	31.0 1.22	22.1 0.87	28.2 1.11	36.1 1.42
14	15	D	10	M22 x 1.0	29.2 1.15	35.8 1.41	22.6 0.89	28.2 1.11	38.1 1.50
16	17	E	12	M25 x 1.0	31.8 1.25	37.3 1.47	23.4 0.92	29.0 1.14	39.6 1.56
18	19	F	14	M28 x 1.0	35.6 1.40	40.6 1.60	24.1 0.95	29.7 1.17	40.9 1.61
20	21	G	16	M31 x 1.0	38.1 1.50	44.5 1.75	24.6 0.97	30.5 1.20	42.4 1.67
22	23	H	18	M34 x 1.0	41.9 1.65	47.0 1.85	25.4 1.00	31.3 1.23	43.9 1.73
24	25	J	20	M37 x 1.0	44.5 1.75	51.6 2.03	25.9 1.02	31.3 1.23	46.5 1.83

1. All entry sizes are shown in Table II. Maximum entry sizes are as shown in Table I. For larger entry sizes than the maximum, a Type II adapter may be supplied. See CH00-0250-016 for further details.
2. Adapter mates to: MIL-C-38999 Series III and IV, Class C, F, K and W, D38999/20, /24, /26, /40, /46 and /47 Connectors. When so mated it shall provide a water-tight seal meeting the requirements of MIL-C-85049, paragraph 3.5.7.
3. These dimensions apply if a self-locking coupling nut is used, modification code "S".

Table II

Entry Size	Ø Z +0.25/-0.50 [+0.010/-0.020]	Ø S ±0.51 [±0.020]	Ø Y ±0.38 [±0.015]	E Max.
03	4.75 0.188	7.92 0.312	11.10 0.438	15.8 0.62
04	6.35 0.250	9.52 0.375	12.70 0.500	16.3 0.64
05	7.92 0.312	11.12 0.438	14.30 0.563	16.8 0.66
06	9.52 0.375	12.70 0.500	15.88 0.625	17.8 0.70
07	11.12 0.438	14.30 0.562	17.50 0.689	18.3 0.72
08	12.70 0.500	15.88 0.625	19.05 0.750	19.8 0.78
09	14.30 0.562	17.50 0.688	20.65 0.813	21.3 0.84
10	15.88 0.625	19.05 0.750	22.23 0.875	22.4 0.88
11	17.50 0.688	20.65 0.812	23.80 0.938	22.9 0.90
12	19.05 0.750	22.23 0.875	25.40 1.000	23.4 0.92
13	20.65 0.812	23.83 0.938	27.00 1.063	24.4 0.96
14	22.23 0.875	25.40 1.000	30.16 1.189	25.4 1.00

Table II (Continued)

Entry Size	Ø Z +0.25/-0.50 [+0.010/-0.020]	Ø S ±0.51 [±0.020]	Ø Y ±0.38 [±0.015]	E Max.
15	23.83 .0938	27.00 1.062	31.75 1.250	25.4 1.00
16	25.40 1.000	28.58 1.125	33.34 1.313	26.4 1.04
18	28.58 1.125	31.75 1.250	36.51 1.438	27.7 1.09
20	31.75 1.250	34.90 1.375	39.69 1.563	29.2 1.15
22	34.90 1.375	38.10 1.500	42.86 1.688	N/A
24	38.10 1.500	41.28 1.625	46.83 1.844	N/A
26	41.28 1.625	44.45 1.750	49.61 1.953	N/A
28	44.45 1.750	47.63 1.875	52.78 2.078	N/A
30	47.65 1.875	50.80 2.000	56.36 2.219	N/A
32	50.80 2.000	54.00 2.125	59.53 2.344	N/A
34	54.00 2.125	57.15 2.250	62.71 2.469	N/A

Braided Adapters

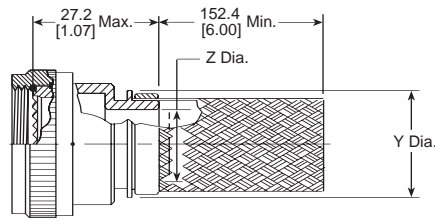

204M0XX-XXXXX

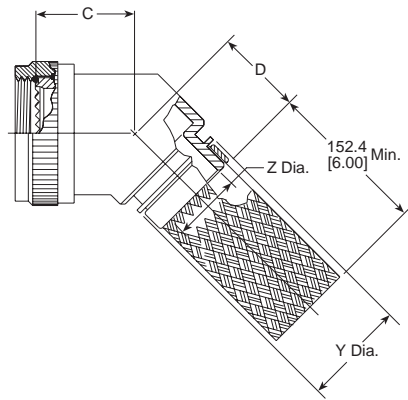

204M1XX-XXXXX

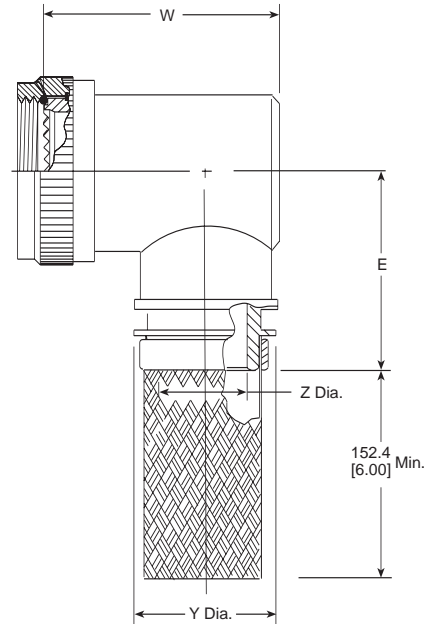

204M2XX-XXXXX

Table of Dimensions

Order No.	Shell Size		Max. Entry* Size Type 1	A Unified Thread Class 2B	Dimensions		
	Series I	Series II			C Max.	D Max.	E Max.
08	9	8	04	.438-28 UNEF	19.8 [0.78]	23.1 [0.91]	29.2 [1.15]
10	11	10	06	.562-24 UNEF	20.3 [0.80]	23.6 [0.93]	30.7 [1.21]
12	13	12	08	.688-24 UNEF	21.1 [0.83]	24.4 [0.96]	32.5 [1.28]
14	15	14	10	.812-20 UNEF	21.6 [0.85]	24.9 [0.98]	34.0 [1.34]
16	17	16	12	.938-20 UNEF	22.4 [0.88]	25.4 [1.00]	35.6 [1.40]
18	19	18	13	1.062-18 UNEF	22.9 [0.90]	26.2 [1.03]	37.1 [1.46]
20	21	20	15	1.188-18 UNEF	23.6 [0.93]	26.9 [1.06]	38.9 [1.53]
22	23	22	16	1.312-18 UNEF	24.4 [0.96]	27.4 [1.08]	40.4 [1.59]
24	25	24	18	1.438-18 UNEF	24.9 [0.98]	28.2 [1.11]	41.9 [1.65]

*For larger than maximum type 1 entry sizes, a two-piece adapter will be supplied. Contact Tyco Electronics for information.

Available in:	Americas	Europe	Asia Pacific
	■	■	■

Braided Adapters
(continued)

Code 41 MIL-C-38999 Series I and II (Continued)

Entry Size Dimensions

Entry Size	Dimensions		
	Z ±0.020 (±0.51)	Y Dia. Min.	W Max.
03	4.75 [.187]	9.98 [.393]	27.2 [1.07]
04	6.35 [.250]	11.58 [.456]	27.2 [1.07]
05	7.92 [.312]	13.08 [.515]	28.7 [1.13]
06	9.53 [.375]	14.76 [.581]	30.2 [1.19]
07	11.13 [.438]	16.33 [.643]	31.8 [1.25]
08	12.70 [.500]	17.91 [.705]	33.5 [1.32]
09	14.27 [.562]	17.91 [.705]	36.6 [1.44]
10	15.88 [.625]	21.11 [.831]	36.6 [1.44]
11	17.48 [.688]	22.68 [.893]	39.9 [1.57]
12	19.05 [.750]	24.21 [.953]	39.9 [1.57]
13	20.62 [.812]	24.21 [.953]	42.9 [1.69]
14	22.23 [.875]	27.46 [1.081]	42.9 [1.69]
15	23.83 [.938]	29.03 [1.143]	46.2 [1.82]
16	25.40 [1.000]	30.61 [1.205]	46.2 [1.82]
18	28.58 [1.125]	35.08 [1.381]	49.3 [1.94]
20	31.75 [1.250]	38.25 [1.506]	—
22	34.93 [1.375]	41.43 [1.631]	—
24	38.10 [1.500]	44.60 [1.756]	—
28	44.45 [1.750]	50.90 [2.004]	—

Molded Part Selection Guide
(Braided)

Tinel-Lock Entry Size	Standard K Parts			Low-Profile D Parts		
	Straight Part No.	90° Part No.	Cable OD (Min.)	Straight Part No.	90° Part No.	Cable OD (Min.)
04	202K232	—	3.3 [0.1]	—	—	—
04	202W232	—	4.3 [0.2]	—	—	—
04	202K121	222K121	5.6 [0.2]	202D211	222D211	6.4 [0.3]
05, 06	202K132	222K132	5.9 [0.2]	202D221	222D221	7.4 [0.3]
07, 08	202K142	222K142	7.1 [0.3]	202D232	222D232	8.4 [0.3]
10, 12	202K153	222K152	8.4 [0.3]	202D242	222D242	9.7 [0.4]
14, 16	202K163	222K163	9.9 [0.4]	202D253	222D253	10.5 [0.4]
18, 20, 22	202K174	222K174	15.7 [0.6]	202D263	222D263	12.2 [0.5]
24	202K185	222K185	16.8 [0.7]	—	—	—

Uniboot Parts

Order No.	Part No.	Cable OD (Min.)
04	202C611	4.8 [0.19]
05, 06, 07	202C621	8.1 [0.32]
08, 10, 12	202C632	12.7 [0.50]
12, 14, 16	202C642	17.5 [0.69]
16, 18, 20, 22	202C653	22.4 [0.88]
24	202C663	22.9 [0.90]

Solid Adapters

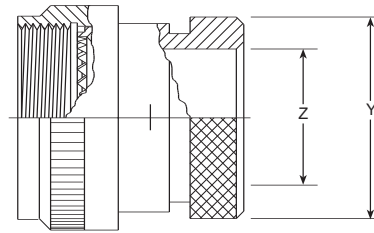

202M1XX-XXX

Table of Dimensions

Order No.	Shell Size Series I	Series II	Thread	Dimensions	
				Y +0.00-0.30 (+0.00) (-0.76) dia.	Z min.
08	9	8	.438-28 UNEF	18.26 [.719]	6.71 [.264]
10	11	10	.562-24 UNEF	21.44 [.844]	9.96 [.392]
12	13	12	.688-24 UNEF	24.61 [.969]	12.85 [.506]
14	15	14	.812-20 UNEF	27.79 [1.094]	16.03 [.631]
16	17	16	.938-20 UNEF	32.54 [1.281]	19.20 [.756]
18	19	18	1.062-18 UNEF	35.71 [1.406]	21.44 [.844]
20	21	20	1.188-18 UNEF	38.89 [1.531]	24.64 [.970]
22	23	22	1.312-18 UNEF	42.06 [1.656]	27.79 [1.094]
24	25	24	1.438-18 UNEF	45.24 [1.781]	30.71 [1.209]

Molded Part Selection Guide (Solid)

Order No.	Standard K Parts			Low-Profile D Parts		
	Straight Part No.	90° Part No.	Cable OD (Min.)	Straight Part No.	90° Part No.	Cable OD (Min.)
08	202K132	222K132	5.9 [0.23]	202D221	222D221	7.4 [0.29]
10	202K142	222K142	7.1 [0.28]	202D232	222D232	8.4 [0.33]
12, 14	202K153	222K152	8.4 [0.33]	202D242	222D242	9.7 [0.38]
16, 18	202K163	222K163	9.9 [0.39]	202D253	222D253	10.5 [0.41]
20, 22, 24	202K174	222K174	15.7 [0.62]	202D263	222D263	12.2 [0.48]

Uniboot Parts

Order No.	Part No.	Cable OD (Min.)
08	202C621	8.1 [0.32]
10	202C632	12.7 [0.50]
12, 14	202C642	17.5 [0.69]
16, 18, 20, 22	202C653	22.4 [0.88]

Available in:	Americas	Europe	Asia Pacific
	■	■	■

Spin-Coupling Adapters

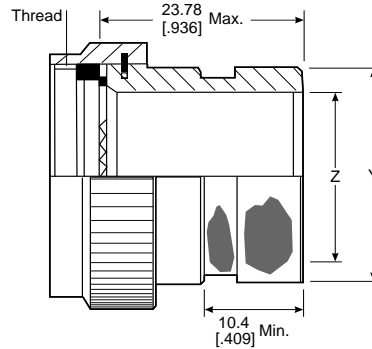

202M2XX-XXX

Table of Dimensions

Order No.	Shell Size Series I	Series II	Thread	Dimensions	
				Y +0.00-0.76 Dia.	Z Min.
08	9	8	.438-28 UNEF	13.54 [0.53]	6.35 [0.25]
10	11	10	.562-24 UNEF	15.37 [0.61]	9.53 [0.38]
12	13	12	.688-24 UNEF	19.66 [0.77]	12.70 [0.50]
14	15	14	.812-20 UNEF	21.29 [0.84]	15.88 [0.63]
16	17	16	.938-20 UNEF	24.46 [0.96]	19.05 [0.75]
18	19	18	1.062-18 UNEF	26.47 [1.04]	20.62 [0.81]
20	21	20	1.188-18 UNEF	30.91 [1.22]	23.80 [0.94]
22	23	22	1.312-18 UNEF	34.42 [1.36]	26.97 [1.06]
24	25	24	1.438-18 UNEF	36.65 [1.44]	30.18 [1.19]

Molded Part Selection Guide (Spin-Coupling)

Order No.	Standard K Parts			Low-Profile D Parts		
	Straight Part No.	90° Part No.	Cable OD (Min.)	Straight Part No.	90° Part No.	Cable OD (Min.)
08	202W232	—	4.3 [0.19]	—	—	—
08	202K121	222K121	5.6 [0.22]	202D211	222D211	6.4 [0.25]
10	202K132	222K132	5.9 [0.23]	202D221	222D221	7.4 [0.29]
12, 14	202K142	222K142	7.1 [0.28]	202D232	222D232	8.4 [0.33]
16, 18	202K153	222K152	8.4 [0.33]	202D242	222D242	9.7 [0.38]
20, 22	202K163	222K163	9.9 [0.39]	202D253	222D253	10.5 [0.41]
24, 28	202K174	222K174	15.7 [0.62]	202D263	222D263	12.2 [0.48]

Uniboot Parts

Order No.	Part No.	Cable OD (Min.)
08	202C611	4.8 [0.19]
10, 12	202C621	8.1 [0.32]
14, 16	202C632	12.7 [0.50]
18, 20	202C642	17.5 [0.69]
22, 24	202C653	22.4 [0.88]

Available in:	Americas	Europe	Asia Pacific
	■	■	■

Tinel-Lock Adapters

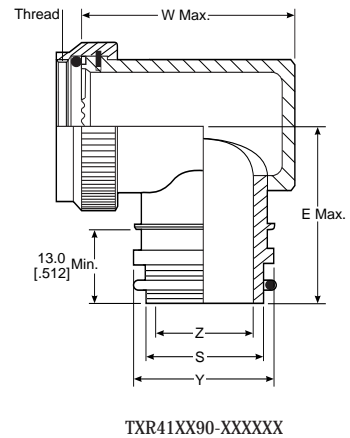
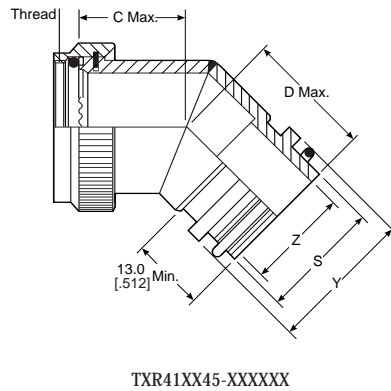
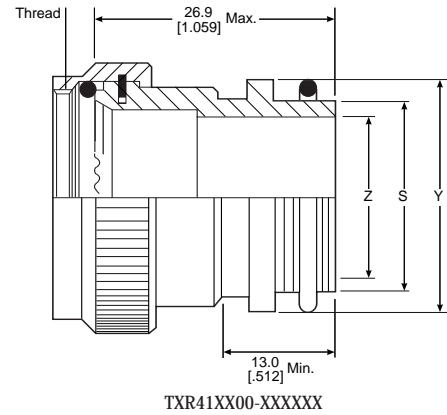

Table of Dimensions

Order No.	Shell Size Series I	Series II	Max. Entry* Size Type 1	A Unified Thread Class 2B	Dimensions		
					C Max.	D Max.	E Max.
08	9	8	—	.438-28 UNEF	17.5 [0.69]	23.1 [0.91]	29.2 [1.15]
10	11	10	—	.562-24 UNEF	18.3 [0.72]	23.6 [0.93]	30.7 [1.21]
12	13	12	08	.688-24 UNEF	18.8 [0.74]	24.4 [0.96]	32.5 [1.28]
14	15	14	10	.812-20 UNEF	19.3 [0.76]	24.9 [0.98]	34.0 [1.34]
16	17	16	12	.938-20 UNEF	20.1 [0.79]	25.4 [1.00]	35.6 [1.40]
18	19	18	13	1.062-18 UNEF	20.6 [0.81]	26.2 [1.03]	37.1 [1.46]
20	21	20	15	1.188-18 UNEF	21.3 [0.84]	26.9 [1.06]	38.9 [1.53]
22	23	22	16	1.312-18 UNEF	22.1 [0.87]	27.4 [1.08]	40.4 [1.59]
24	25	24	18	1.438-18 UNEF	22.6 [0.89]	28.2 [1.11]	41.9 [1.65]

*For larger than maximum type 1 entry sizes, a two-piece adapter will be supplied. Contact Tyco Electronics for information.

Available in:	Americas	Europe	Asia Pacific
	■	■	■

Tinel-Lock Adapters
(continued)

Entry Size Dimensions

Entry Size	Dimensions			
	Z +0.25-0.5	S Diameter (Min.-Max.)	Y ±0.38	W Max.
04	6.35 [0.25]	9.39-9.56 [0.37-0.38]	13.97 [0.55]	27.2 [1.07]
05	7.92 [0.31]	10.97-11.13 [0.43-0.44]	15.54 [0.61]	28.7 [1.13]
06	9.52 [0.37]	12.57-12.73 [0.49-0.50]	17.14 [0.67]	30.2 [1.19]
07	11.09 [0.44]	14.12-14.31 [0.55-0.56]	18.71 [0.74]	31.8 [1.25]
08	12.70 [0.50]	15.72-15.91 [0.62-0.63]	20.32 [0.80]	33.5 [1.32]
10	15.87 [0.62]	18.84-19.11 [0.74-0.75]	23.49 [0.92]	36.6 [1.44]
12	19.05 [0.75]	22.02-22.28 [0.87-0.88]	26.67 [1.05]	39.9 [1.57]
14	22.23 [0.88]	25.17-25.46 [0.99-1.00]	29.84 [1.17]	42.9 [1.69]
16	25.4 [1.00]	28.34-28.63 [1.12-1.13]	33.02 [1.30]	46.2 [1.82]
18	28.57 [1.12]	31.52-31.81 [1.24-1.25]	36.19 [1.42]	49.3 [1.94]

Molded Part Selection Guide
(Tinel)

Order No.	Standard K Parts			Low-Profile D Parts		
	Straight Part No.	90° Part No.	Cable OD (Min.)	Straight Part No.	90° Part No.	Cable OD (Min.)
04	202K232	—	3.3 [0.1]	—	—	—
04	202W232	—	4.3 [0.2]	—	—	—
04	202K121	222K121	5.6 [0.2]	202D211	222D211	6.4 [0.3]
05, 06	202K132	222K132	5.9 [0.2]	202D221	222D221	7.4 [0.3]
07, 08	202K142	222K142	7.1 [0.3]	202D232	222D232	8.4 [0.3]
10, 12	202K153	222K152	8.4 [0.3]	202D242	222D242	9.7 [0.4]
14, 16	202K163	222K163	9.9 [0.4]	202D253	222D253	10.5 [0.4]
18, 20, 22	202K174	222K174	15.7 [0.6]	202D263	222D263	12.2 [0.5]
24	202K185	222K185	16.8 [0.7]	—	—	—

Uniboot Parts

Order No.	Part No.	Cable OD (Min.)
04	202C611	4.8 [0.19]
05, 06, 07	202C621	8.1 [0.32]
08, 10, 12	202C632	12.7 [0.50]
12, 14, 16	202C642	17.5 [0.69]
16, 18, 20, 22	202C653	22.4 [0.88]
24	202C663	22.9 [0.90]

CRES-Lock Adapters (USA)
BND Adapters (Europe)

Code 41 Band Strap
Adapter

Notes:

1. This product is designed to terminate a braided cable shield by means of a band strap and a heat shrinkable lipped boot to a connector.
2. See CH00-0250-016 for ordering information, modifications and additional dimensions.
3. See drawing BND-XX25S for band strap dimensions and information.
4. Adapter to be permanently marked with code identification number and full part number (e.g. 06090-BND41AB00-1812). Band strap shall bear no part marking.
5. All entry sizes are shown in Table II. Maximum entry sizes are as shown in Table I. For larger entry sizes than the maximum, a Type II adapter may be supplied. See CH00-0250-016 for further details.
6. Adapter mates to: MIL-C-38999 Series I and II, Class E and T, MS27466, MS27467, MS27468, MS27472, MS27473, MS27474, MS27479, MS27480, MS27481, MS27484, MS27497, MS27652, MS27653 and MS27656 Connectors.

For additional codes available, contact Tyco Electronics.

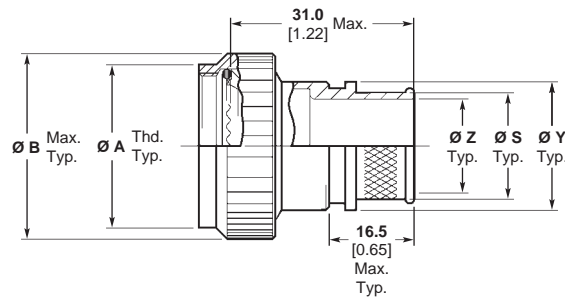
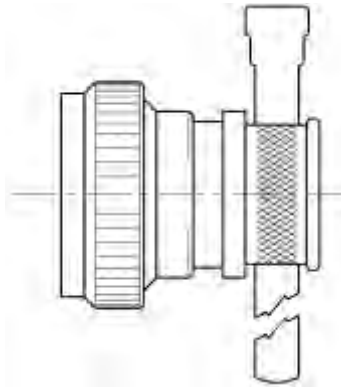

Straight Adapter
Code 00

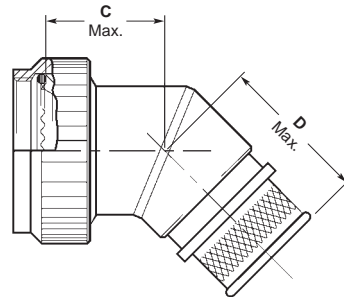

45° Adapter
Code 45

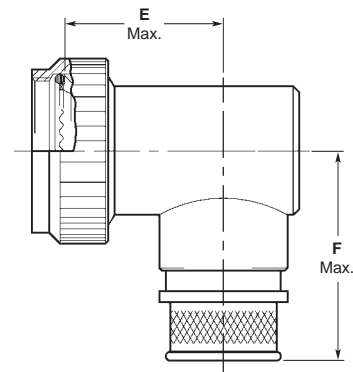

90° Adapter
Code 90

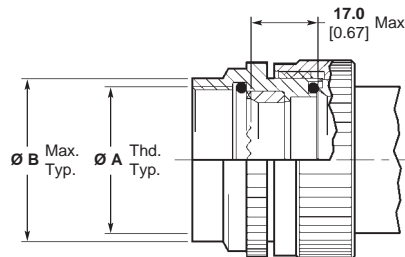

Type II Modification
(See Note 5)

Available in:	Americas	Europe	Asia Pacific
	■	■	■

CRES-Lock Adapters (USA)
BND Adapters (Europe)
(continued)

Code 41 Band Strap
Adapter (Continued)

Code 41 MIL-C-38999 Series I and II (Continued)

Table I

Order Number	Shell Size ²		Entry Size Max. Type I ¹	Ø A Unified Thread UNEF Class 2B	Ø B Max.	Ø B Max. ³	C Max.	D Max.	F Max.
	Series I	Series II							
08	9	08	04	0.4375-28	19.1 0.75	24.6 0.97	17.5 0.69	27.2 1.07	33.3 1.31
10	11	10	06	0.5625-24	20.8 0.85	27.0 1.06	18.3 0.72	27.7 1.09	34.8 1.37
12	13	12	08	0.6875-24	25.4 1.00	31.0 1.22	18.8 0.74	28.4 1.12	36.6 1.44
14	15	14	10	0.8125-20	27.2 1.10	35.8 1.41	19.3 0.76	29.0 1.14	38.1 1.50
16	17	16	12	0.9375-20	31.8 1.25	37.3 1.47	20.1 0.79	29.5 1.16	39.6 1.56
18	19	18	13	1.0625-18	35.6 1.40	40.6 1.60	20.6 0.81	30.2 1.19	41.1 1.62
20	21	20	15	1.1875-18	38.1 1.50	44.5 1.75	21.3 0.84	31.0 1.22	42.9 1.69
22	23	22	16	1.3125-18	41.9 1.65	46.8 1.84	22.1 0.87	31.5 1.24	44.5 1.75
24	25	24	18	1.4375-18	44.5 1.75	51.6 2.03	22.6 0.89	32.3 1.27	46.0 1.81

1. All entry sizes are shown in Table II. Maximum entry sizes are as shown in Table I. For larger entry sizes than the maximum, a Type II adapter may be supplied. See CH00-0250-016 for further details.
2. Adapter mates to: MIL-C-38999 Series I and II, Class E and T, MS27466, MS27467, MS27468, MS27472, MS27473, MS27474, MS27479, MS27480, MS27481, MS27484, MS27497, MS27652, MS27653 and MS27656 Connectors.
3. These dimensions apply if a self-locking coupling nut is used, modification code "S".

Table II

Entry Size	Ø Z +0.25/-0.50 [+0.010/-0.020]	Ø S ±0.51 [±0.020]	Ø Y ±0.38 [±0.015]	E Max.
03	4.75 0.188	7.92 0.312	11.10 0.438	15.3 0.60
04	6.35 0.250	9.52 0.375	12.70 0.500	16.3 0.64
05	7.92 0.312	11.12 0.438	14.30 0.563	16.8 0.66
06	9.52 0.375	12.70 0.500	15.88 0.625	17.8 0.70
07	11.12 0.438	14.30 0.562	17.50 0.689	18.8 0.74
08	12.70 0.500	15.88 0.625	19.05 0.750	19.3 0.76
09	14.30 0.562	17.50 0.688	20.65 0.813	20.3 0.80
10	15.88 0.625	19.05 0.750	22.23 0.875	21.3 0.84
11	17.50 0.688	20.65 0.812	23.80 0.938	21.8 0.86
12	19.05 0.750	22.23 0.875	25.40 1.000	22.9 0.90
13	20.65 0.812	23.83 0.938	27.00 1.063	23.8 0.94
14	22.23 0.875	25.40 1.000	30.16 1.189	24.4 0.96

Table II (Continued)

Entry Size	Ø Z +0.25/-0.50 [+0.010/-0.020]	Ø S ±0.51 [±0.020]	Ø Y ±0.38 [±0.015]	E Max.
15	23.83 .0938	27.00 1.062	31.75 1.250	25.4 1.00
16	25.40 1.000	28.58 1.125	33.34 1.313	25.9 1.02
18	28.58 1.125	31.75 1.250	36.51 1.438	27.4 1.08
20	31.75 1.250	34.90 1.375	39.69 1.563	N/A
22	34.90 1.375	38.10 1.500	42.86 1.688	N/A
24	38.10 1.500	41.28 1.625	46.83 1.844	N/A
26	41.28 1.625	44.45 1.750	49.61 1.953	N/A
28	44.45 1.750	47.63 1.875	52.78 2.078	N/A
30	47.65 1.875	50.80 2.000	56.36 2.219	N/A
32	50.80 2.000	54.00 2.125	59.53 2.344	N/A
34	54.00 2.125	57.15 2.250	62.71 2.469	N/A

Braided Adapters



Code 54 MIL-C-5015 (MS3400), MIL-C-26482 Series 2,
MIL-C-83723 Series I and III, MIL-C-81703 Series III

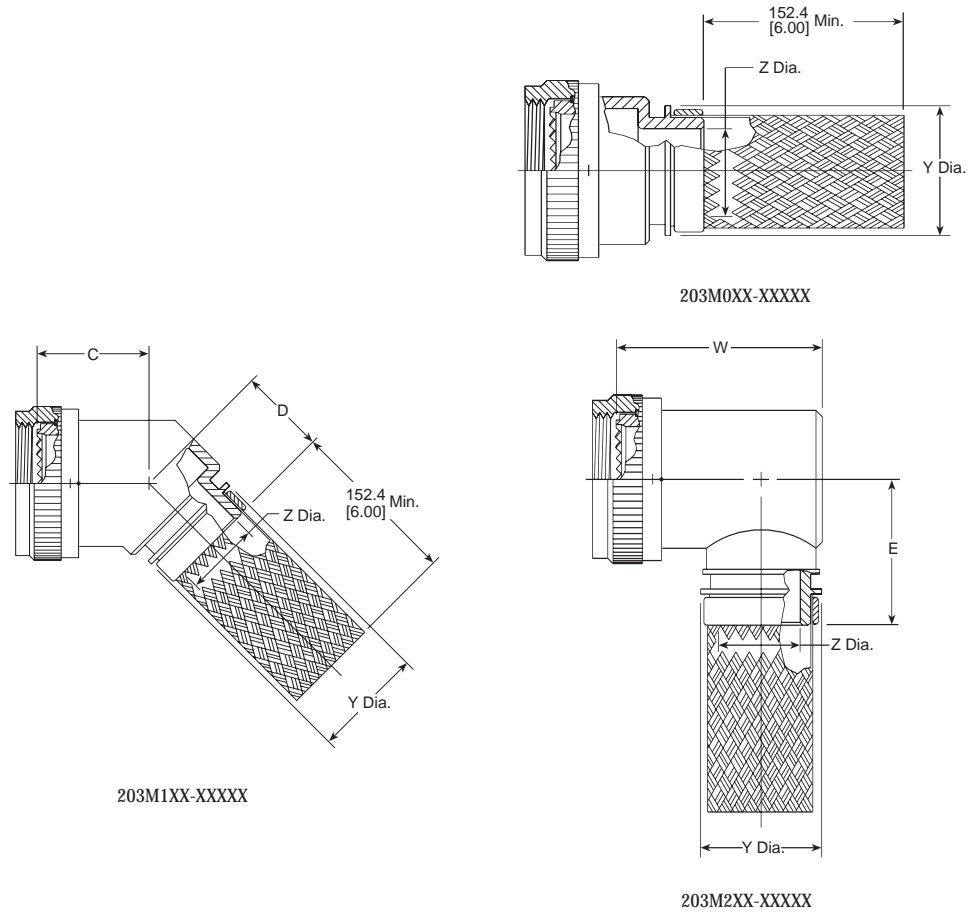

Table of Dimensions

Order No.	Shell Size		Max. Entry Size Type 1*	Thread	Dimensions		
	MIL-C-81703	MIL-C-5015			C Max.	D Max.	E Max.
03	3	—	04	.562-24 UNEF	19.10 [0.75]	23.10 [0.91]	28.70 [1.13]
08	—	8 & 8S	04	.500-20 UNF	19.10 [0.75]	23.10 [0.91]	27.90 [1.10]
10	—	10, 10S & 10 SL	06	.625-24 UNEF	19.60 [0.77]	23.60 [0.93]	29.50 [1.16]
12	7	12 & 12S	08	.750-20 UNEF	20.30 [0.80]	24.10 [0.95]	31.00 [1.22]
14	12	14 & 14S	08	.875-20 UNEF	20.80 [0.82]	24.60 [0.97]	32.50 [1.28]
16	19	16 & 16S	10	1.000-20 UNEF	21.30 [0.84]	25.40 [1.00]	34.30 [1.35]
18	27	18	12	1.062-18 UNEF	21.80 [0.86]	25.70 [1.01]	35.60 [1.40]
20	37	20	14	1.188-18 UNEF	22.40 [0.88]	26.40 [1.04]	37.10 [1.46]
22	—	22	16	1.312-18 UNEF	23.10 [0.91]	26.90 [1.06]	38.90 [1.53]
24	—	24	18	1.438-18 UNEF	23.60 [0.93]	27.70 [1.09]	40.40 [1.59]
28	—	28	22	1.750-18 UNS	24.90 [0.98]	29.20 [1.15]	45.20 [1.78]
32	—	32	24	2.000-18 UNS	26.20 [1.03]	30.50 [1.20]	48.30 [1.90]
36	—	36	24	2.250-16 UN	27.40 [1.08]	31.80 [1.25]	51.60 [2.03]
40	—	40	24	2.500-16 UN	29.00 [1.14]	33.30 [1.31]	54.60 [2.15]
44	—	44	24	2.750-16 UN	30.20 [1.19]	34.50 [1.36]	57.90 [2.28]
48	—	48	24	3.000-16 UN	31.50 [1.24]	35.10 [1.38]	61.00 [2.40]
61	61	—	18	1.500-18 UNEF	23.90 [0.94]	27.90 [1.10]	41.10 [1.62]

*For larger than maximum type 1 entry sizes, a two-piece adapter will be supplied. Contact Tyco Electronics for information.

Available in:	Americas	Europe	Asia Pacific
	■	■	■

Code 54 MIL-C-5015 (MS3400), MIL-C-26482 Series 2,
MIL-C-83723 Series I and III, MIL-C-81703 Series III (Continued)

Entry Size Dimensions

Entry Size	Dimensions			
	Z +0.25-0.5	S Diameter (Min.-Max.)	Y ±0.38	W Max.
04	6.35 [0.25]	9.39-9.56 [0.37-0.38]	13.97 [0.55]	28.4 [1.12]
05	7.92 [0.31]	10.97-11.13 [0.43-0.44]	15.54 [0.61]	30.2 [1.19]
06	9.52 [0.37]	12.57-12.73 [0.49-0.50]	17.14 [0.67]	31.8 [1.25]
07	11.09 [0.44]	14.12-14.31 [0.55-0.56]	18.71 [0.74]	33.3 [1.31]
08	12.7 [0.50]	15.72-15.91 [0.62-0.63]	20.32 [0.80]	35.1 [1.38]
10	15.87 [0.62]	18.84-19.11 [0.74-0.75]	23.49 [0.92]	38.1 [1.50]
12	19.05 [0.75]	22.02-22.28 [0.87-0.88]	26.67 [1.05]	41.1 [1.62]
14	22.23 [0.88]	25.17-25.46 [0.99-1.00]	29.84 [1.17]	44.5 [1.75]
16	25.4 [1.00]	28.34-28.63 [1.12-1.13]	33.02 [1.30]	47.8 [1.88]
18	28.57 [1.12]	31.52-31.81 [1.24-1.25]	36.19 [1.42]	50.8 [2.00]
20	31.75 [1.25]	34.69-34.98 [1.37-1.38]	39.37 [1.55]	53.8 [2.12]
22	34.93 [1.38]	37.79-38.15 [1.49-1.50]	42.55 [1.68]	57.2 [2.25]
24	38.1 [1.50]	40.97-41.33 [1.61-1.63]	45.72 [1.80]	60.5 [2.38]

Molded Part Selection Guide
(Braided)

Tinel-Lock Entry Size	Standard K Parts			Low-Profile D Parts		
	Straight Part No.	90° Part No.	Cable OD (Min.)	Straight Part No.	90° Part No.	Cable OD (Min.)
04	202K232	—	3.3 [0.1]	—	—	—
04	202W232	—	4.3 [0.2]	—	—	—
04	202K121	222K121	5.6 [0.2]	202D211	222D211	6.4 [0.3]
05, 06	202K132	222K132	5.9 [0.2]	202D221	222D221	7.4 [0.3]
07, 08	202K142	222K142	7.1 [0.3]	202D232	222D232	8.4 [0.3]
10, 12	202K153	222K152	8.4 [0.3]	202D242	222D242	9.7 [0.4]
14, 16	202K163	222K163	9.9 [0.4]	202D253	222D253	10.5 [0.4]
18, 20, 22	202K174	222K174	15.7 [0.6]	202D263	222D263	12.2 [0.5]
24	202K185	222K185	16.8 [0.7]	—	—	—

Uniboot Parts

Tinel-Lock Entry Size	Part No.	Cable OD (Min.)
04	202C611	4.8 [0.19]
05, 06, 07	202C621	8.1 [0.32]
08, 10, 12	202C632	12.7 [0.50]
12, 14, 16	202C642	17.5 [0.69]
16, 18, 20, 22	202C653	22.4 [0.88]
24	202C663	22.9 [0.90]

Solid Adapters



Code 54 MIL-C-5015 (MS3400), MIL-C-26482 Series 2,
MIL-C-83723 Series I and III, MIL-C-81703 Series III (Continued)

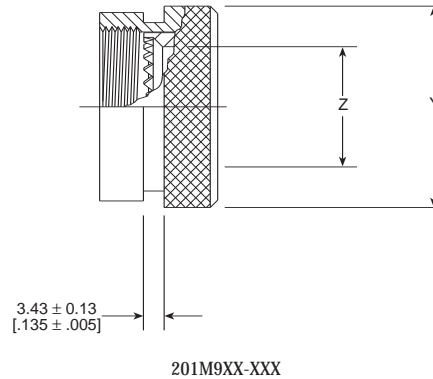

Table of Dimensions

Order No.	Shell Size		Thread	Dimensions	
	MIL-C-81703	MIL-C-5015		Y +0.00-0.51 Dia.	Z Dia. Min.
03	3	—	.562-24 UNEF	13.54 [0.53]	6.35 [0.25]
08	—	8 & 8S	.500-20 UNF	13.54 [0.53]	6.35 [0.25]
10	—	10, 10S & 10SL	.625-24 UNEF	15.37 [0.61]	9.02 [0.36]
12	7	12 & 12S	.750-20 UNEF	19.66 [0.77]	12.47 [0.49]
14	12	14 & 14S	.875-20 UNEF	21.29 [0.84]	14.35 [0.56]
16	19	16 & 16S	1.000-20 UNEF	24.46 [0.96]	17.53 [0.69]
18	27	18	1.062-18 UNEF	26.47 [1.04]	19.53 [0.77]
20	37	20	1.188-18 UNEF	30.91 [1.22]	22.71 [0.89]
22	—	22	1.312-18 UNEF	34.42 [1.36]	25.88 [1.02]
24	—	24	1.438-18 UNEF	36.65 [1.44]	28.80 [1.13]
28	—	28	1.750-18 UNS	43.41 [1.71]	34.77 [1.37]
32	—	32	2.000-18 UNS	48.74 [1.92]	41.02 [1.61]
36	—	36	2.250-16 UN	55.09 [2.17]	46.48 [1.83]
40	—	40	2.500-16 UN	61.01 [2.40]	51.94 [2.04]
44	—	44	2.750-16 UN	67.49 [2.66]	58.42 [2.30]
48	—	48	3.000-16 UN	73.84 [2.91]	64.77 [2.55]
61	61	—	1.500-18 UNEF	36.65 [1.44]	29.82 [1.17]

Molded Part Selection Guide (Solid)

Order No.	Standard K Parts			Low-Profile D Parts		
	Straight Part No.	90° Part No.	Cable OD (Min.)	Straight Part No.	90° Part No.	Cable OD (Min.)
03	202K132	222K132	5.9 [0.23]	202D221	222D221	7.4 [0.29]
10	202K142	222K142	7.1 [0.28]	202D232	222D232	8.4 [0.33]
12, 14	202K153	222K152	8.4 [0.33]	202D242	222D242	9.7 [0.38]
16, 18, 19, 27	202K163	222K163	9.9 [0.39]	202D253	222D253	10.5 [0.41]
20, 22, 24, 28, 37	202K174	222K174	15.7 [0.62]	202D263	222D263	12.2 [0.48]
28, 32	202K185	222K185	16.8 [0.66]	—	—	—

Uniboost Parts

Order No.	Part No.	Cable OD (Min.)
08	202C621	8.1 [0.32]
7, 10, 12	202C632	12.7 [0.50]
12, 14	202C642	17.5 [0.69]
24, 27, 37, 61	202C653	22.4 [0.88]

Available in:	Americas	Europe	Asia Pacific
	■	■	■



Code 54 MIL-C-5015 (MS3400), MIL-C-26482 Series 2,
MIL-C-83723 Series I and III, MIL-C-81703 Series III (Continued)

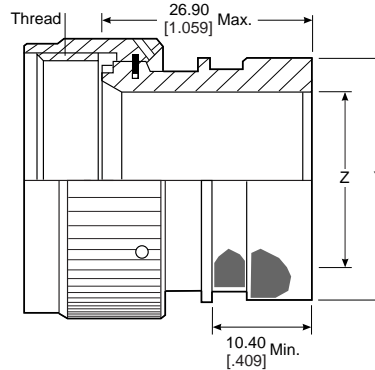

201M1XX-XXX

Table of Dimensions

Order No.	Shell Size		Thread	Dimensions	
	MIL-C-81703	MIL-C-5015		Y +0.00-0.51 Dia.	Z Dia. Min.
03	3	—	.562-24 UNEF	13.54 [0.53]	6.35 [0.25]
08	—	8 & 8S	.500-20 UNF	13.54 [0.53]	6.35 [0.25]
10	—	10, 10S & 10SL	.625-24 UNEF	15.37 [0.61]	9.02 [0.36]
12	7	12 & 12S	.750-20 UNEF	19.66 [0.77]	12.47 [0.49]
14	12	14 & 14S	.875-20 UNEF	21.29 [0.84]	14.35 [0.56]
16	19	16 & 16S	1.000-20 UNEF	24.46 [0.96]	17.53 [0.69]
18	27	18	1.062-18 UNEF	26.47 [1.04]	19.53 [0.77]
20	37	20	1.188-18 UNEF	30.91 [1.22]	22.71 [0.89]
22	—	22	1.312-18 UNEF	34.42 [1.36]	25.88 [1.02]
24	—	24	1.438-18 UNEF	36.65 [1.44]	28.80 [1.13]
28	—	28	1.750-18 UNS	43.41 [1.71]	34.77 [1.37]
32	—	32	2.000-18 UNS	48.74 [1.92]	41.02 [1.61]
36	—	36	2.250-16 UN	55.09 [2.17]	46.48 [1.83]
40	—	40	2.500-16 UN	61.01 [2.40]	51.94 [2.04]
44	—	44	2.750-16 UN	67.49 [2.66]	58.42 [2.30]
48	—	48	3.000-16 UN	73.84 [2.91]	64.77 [2.55]
61	61	—	1.500-18 UNEF	36.65 [1.44]	29.82 [1.17]

Molded Part Selection Guide (Spin-coupling)

Order No.	Standard K Parts			Low-Profile D Parts		
	Straight Part No.	90° Part No.	Cable OD (Min.)	Straight Part No.	90° Part No.	Cable OD (Min.)
03, 08	202W232	—	4.3 [0.19]	—	—	—
03, 08	202K121	222K121	5.6 [0.22]	202D211	222D211	6.4 [0.25]
10, 11	202K132	222K132	5.9 [0.23]	202D221	222D221	7.4 [0.29]
12, 14	202K142	222K142	7.1 [0.28]	202D232	222D232	8.4 [0.33]
16, 18	202K153	222K152	8.4 [0.33]	202D242	222D242	9.7 [0.38]
20, 22	202K163	222K163	9.9 [0.39]	202D253	222D253	10.5 [0.41]
24, 28, 61	202K174	222K174	15.7 [0.62]	202D263	222D263	12.2 [0.48]
32, 36	202K185	222K185	16.8 [0.66]	—	—	—

Uniboot Parts

Order No.	Part No.	Cable OD (Min.)
08	202C621	8.1 [0.32]
7, 10, 12	202C632	12.7 [0.50]
12, 14	202C642	17.5 [0.69]
24, 27, 37, 61	202C653	22.4 [0.88]

Available in:	Americas	Europe	Asia Pacific
	■	■	■

Tinel-Lock Adapters



Adapter Products

Code 54 MIL-C-5015 (MS3400), MIL-C-26482 Series 2,
MIL-C-83723 Series I and III, MIL-C-81703 Series III (Continued)

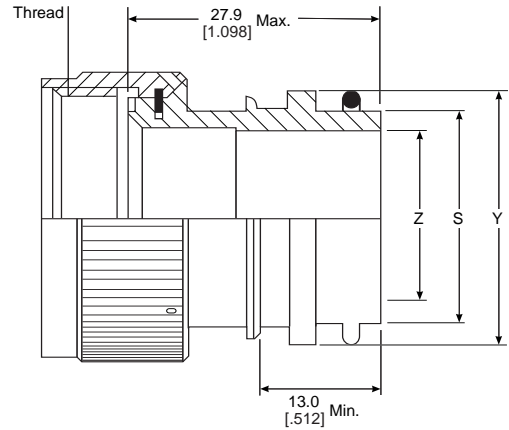

TXR54XX00-XXXXXX

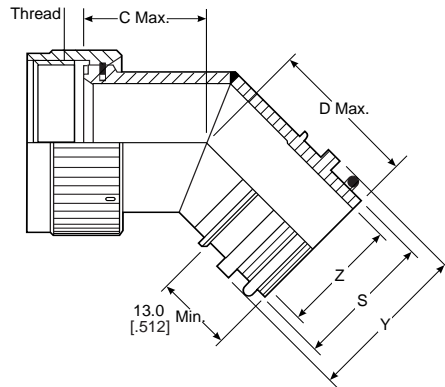

TXR54XX45-XXXXXX

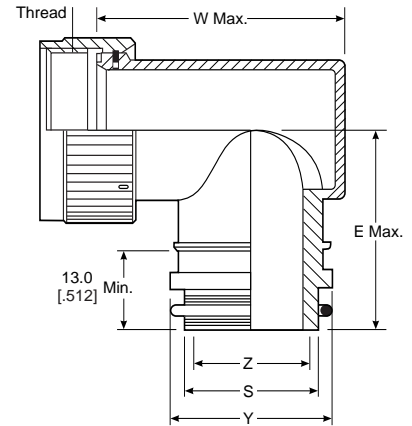

TXR54XX90-XXXXXX

Available in:	Americas	Europe	Asia Pacific
	■	■	■

Electronics

Code 54 MIL-C-5015 (MS3400), MIL-C-26482 Series 2,
MIL-C-83723 Series I and III, MIL-C-81703 Series III (Continued)

Tinel-Lock Adapters
(continued)

Table of Dimensions

Order No.	Shell Size		Max. Entry Size Type 1*	Thread	Dimensions		
	MIL-C-81703	MIL-C-5015			C Max.	D Max.	E Max.
03	3	—	04	.562-24 UNEF	19.10 [0.75]	23.10 [0.91]	28.70 [1.13]
08	—	8 & 8S	04	.500-20 UNF	19.10 [0.75]	23.10 [0.91]	27.90 [1.10]
10	—	10, 10S & 10 SL	06	.625-24 UNEF	19.60 [0.77]	23.60 [0.93]	29.50 [1.16]
12	7	12 & 12S	08	.750-20 UNEF	20.30 [0.80]	24.10 [0.95]	31.00 [1.22]
14	12	14 & 14S	08	.875-20 UNEF	20.80 [0.82]	24.60 [0.97]	32.50 [1.28]
16	19	16 & 16S	10	1.000-20 UNEF	21.30 [0.84]	25.40 [1.00]	34.30 [1.35]
18	27	18	12	1.062-18 UNEF	21.80 [0.86]	25.70 [1.01]	35.60 [1.40]
20	37	20	14	1.188-18 UNEF	22.40 [0.88]	26.40 [1.04]	37.10 [1.46]
22	—	22	16	1.312-18 UNEF	23.10 [0.91]	26.90 [1.06]	38.90 [1.53]
24	—	24	18	1.438-18 UNEF	23.60 [0.93]	27.70 [1.09]	40.40 [1.59]
28	—	28	22	1.750-18 UNS	24.90 [0.98]	29.20 [1.15]	45.20 [1.78]
32	—	32	24	2.000-18 UNS	26.20 [1.03]	30.50 [1.20]	48.30 [1.90]
36	—	36	24	2.250-16 UN	27.40 [1.08]	31.80 [1.25]	51.60 [2.03]
40	—	40	24	2.500-16 UN	29.00 [1.14]	33.30 [1.31]	54.60 [2.15]
44	—	44	24	2.750-16 UN	30.20 [1.19]	34.50 [1.36]	57.90 [2.28]
48	—	48	24	3.000-16 UN	31.50 [1.24]	35.10 [1.38]	61.00 [2.40]
61	61	—	18	1.500-18 UNEF	23.90 [0.94]	27.90 [1.10]	41.10 [1.62]

*For larger than maximum type 1 entry sizes, a two-piece adapter will be supplied. Contact Tyco Electronics for information.

Entry Size Dimensions

Entry Size	Dimensions			
	Z +0.25-0.5	S Diameter (Min.-Max.)	Y ±0.38	W Max.
04	6.35 [0.25]	9.39—9.56 [0.37—0.38]	13.97 [0.55]	28.4 [1.12]
05	7.92 [0.31]	10.97—11.13 [0.43—0.44]	15.54 [0.61]	30.2 [1.19]
06	9.52 [0.37]	12.57—12.73 [0.49—0.50]	17.14 [0.67]	31.8 [1.25]
07	11.09 [0.44]	14.12—14.31 [0.55—0.56]	18.71 [0.74]	33.3 [1.31]
08	12.70 [0.50]	15.72—15.91 [0.62—0.63]	20.32 [0.80]	35.1 [1.38]
10	15.87 [0.62]	18.84—19.11 [0.74—0.75]	23.49 [0.92]	38.1 [1.50]
12	19.05 [0.75]	22.02—22.28 [0.87—0.88]	26.67 [1.05]	41.1 [1.62]
14	22.23 [0.88]	25.17—25.46 [0.99—1.00]	29.84 [1.17]	44.5 [1.75]
16	25.40 [1.00]	28.34—28.63 [1.12—1.13]	33.02 [1.30]	47.8 [1.88]
18	28.57 [1.12]	31.52—31.81 [1.24—1.25]	36.19 [1.42]	50.8 [2.00]
20	31.75 [1.25]	34.69-34.98 [1.37-1.38]	39.37 [1.55]	53.8 [2.12]
22	34.93 [1.38]	37.79-38.15 [1.49-1.50]	42.55 [1.68]	57.2 [2.25]
24	38.10 [1.50]	40.97-41.33 [1.61-1.63]	45.72 [1.80]	60.5 [2.38]

Molded Part Selection Guide
(Tinel)

Tinel-Lock Entry Size	Standard K Parts			Low-Profile D Parts		
	Straight Part No.	90° Part No.	Cable OD (Min.)	Straight Part No.	90° Part No.	Cable OD (Min.)
04	202K232	—	3.3 [0.1]	—	—	—
04	202W232	—	4.3 [0.2]	—	—	—
04	202K121	222K121	5.6 [0.2]	202D211	222D211	6.4 [0.3]
05, 06	202K132	222K132	5.9 [0.2]	202D221	222D221	7.4 [0.3]
07, 08	202K142	222K142	7.1 [0.3]	202D232	222D232	8.4 [0.3]
10, 12	202K153	222K152	8.4 [0.3]	202D242	222D242	9.7 [0.4]
14, 16	202K163	222K163	9.9 [0.4]	202D253	222D253	10.5 [0.4]
18, 20, 22	202K174	222K174	15.7 [0.6]	202D263	222D263	12.2 [0.5]
24	202K185	222K185	16.8 [0.7]	—	—	—

Uniboot Parts

Tinel-Lock Entry Size	Part No.	Cable OD (Min.)
04	202C611	4.8 [0.19]
05, 06, 07	202C621	8.1 [0.32]
08, 10, 12	202C632	12.7 [0.50]
12, 14, 16	202C642	17.5 [0.69]
16, 18, 20, 22	202C653	22.4 [0.88]
24	202C663	22.9 [0.90]

Code 54 MIL-C-5015 (MS3400), MIL-C-26482 Series 2,
MIL-C-83723 Series I and III, MIL-C-81703 Series III (Continued)

CRES-Lock Adapters (USA)
BND Adapters (Europe)

Code 54 Band Strap
Adapter

Notes:

1. This product is designed to terminate a braided cable shield by means of a band strap and a heat shrinkable lipped boot to a connector.
2. See CH00-0250-016 for ordering information, modifications and additional dimensions.
3. See drawing BND-XX25S for band strap dimensions and information.
4. Adapter to be permanently marked with code identification number and full part number (e.g. 06090-BND54AB00-1812). Band strap shall bear no part marking.
5. All entry sizes are shown in Table II. Maximum entry sizes are as shown in Table I. For larger entry sizes than the maximum, a Type II adapter may be supplied. See CH00-0250-016 for further details.

For additional codes available, contact Tyco Electronics.

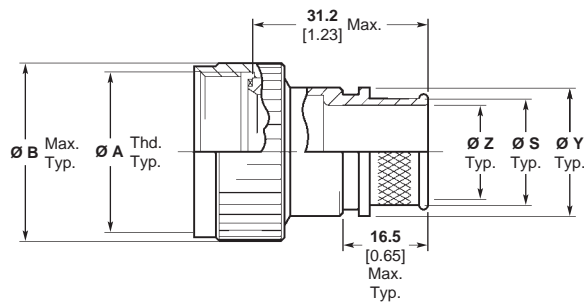
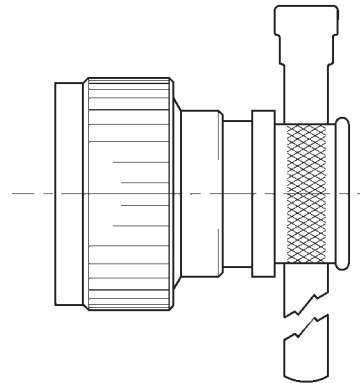

Straight Adapter
Code 00

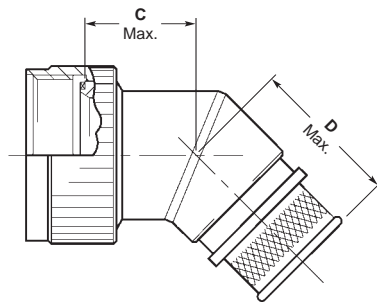

45° Adapter
Code 45

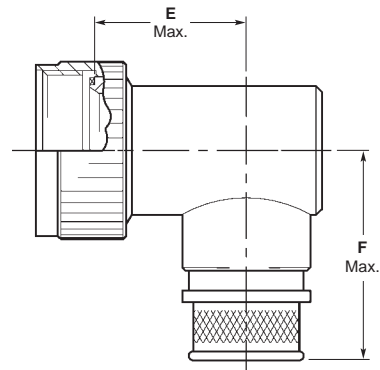

90° Adapter
Code 90

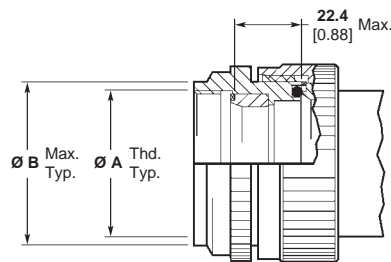

Type II Modification
(See Note 5)

Available in:	Americas	Europe	Asia Pacific
	■	■	■

Electronics

Code 54 MIL-C-5015 (MS3400), MIL-C-26482 Series 2, MIL-C-83723 Series I and III, MIL-C-81703 Series III (Continued)

CRES-Lock Adapters (USA)
BND Adapters (Europe)
(continued)

Code 54 Band Strap
Adapter (Continued)

Table I

Order Number	Shell Size		Entry Size Max. Type I ¹	Ø A Unified Thread Class 2B	Ø B Max.	Ø B Max. ¹	C Max.	D Max.	F Max.
	Series ²	Series ³							
08	—	08	04	0.5000-20 UNF	15.7 0.67	22.6 0.89	19.0 0.75	26.2 1.03	31.0 1.22
10	—	10	06	0.6250-24 UNEF	18.5 0.73	25.7 1.01	19.6 0.77	26.7 1.05	32.5 1.28
12	7	12	08	0.7500-20 UNEF	21.8 0.86	29.0 1.14	20.3 0.80	27.2 1.07	34.3 1.35
14	12	14	09	0.8750-20 UNEF	24.9 0.98	32.0 1.26	20.9 0.82	27.7 1.09	35.6 1.40
16	19	16	11	0.9375-20 UNEF	28.2 1.11	35.3 1.39	21.3 0.84	28.4 1.12	37.1 1.46
18	27	18	12	1.0000-20 UNEF	31.0 1.22	38.4 1.51	21.8 0.86	28.7 1.13	38.9 1.53
20	37	20	14	1.1875-18 UNEF	34.3 1.35	41.7 1.64	22.4 0.88	29.5 1.16	40.4 1.59
22	—	22	16	1.3125-18 UNEF	37.3 1.47	44.7 1.76	23.1 0.91	30.0 1.18	41.9 1.65
24	—	24	18	1.4375-18 UNEF	40.5 1.59	48.0 1.89	23.6 0.93	30.7 1.21	43.4 1.71
28	—	28	22	1.7500-18 UNS	50.0 1.97	54.4 2.14	24.9 0.98	31.8 1.25	48.3 1.90
32	—	32	26	2.0000-18 UNS	56.4 2.22	61.0 2.40	26.2 1.03	33.3 1.31	51.6 2.03
36	—	36	28	2.2500-16 UN	62.7 2.47	67.1 2.64	27.4 1.08	34.3 1.35	54.6 2.15
40	—	40	32	2.5000-16 UN	69.1 2.72	73.4 2.89	28.4 1.12	35.6 1.40	57.7 2.27
44	—	44	34	2.75000-16 UN	75.4 2.97	79.8 3.14	29.7 1.17	36.8 1.45	61.0 2.40
48	—	48	34	3.0000-16 UN	81.8 3.22	86.1 3.39	31.0 1.22	38.1 1.50	64.0 2.52
61	61	—	18	1.5000-18 UNEF	41.9 1.65	47.8 1.88	23.9 0.94	30.7 1.21	44.2 1.74

- All entry sizes are shown in Table II. Maximum entry sizes are as shown in Table I. For larger entry sizes than the maximum, a Type II adapter may be supplied. See CH00-0250-016 for further details.
- Adapter mates to: MIL-C-81703 Series III, MS3424, MS3446, MS3464, MS3467, MS3468, Class E and L Connectors.
- Adapter mates to MIL-C-5015G, MS3400 Series, Class D, E, K, L, U and W: MS3400, MS3401, MS3404, MS3406, MS3450, MS3451, MS3454, MS3456, MS3470, MS3471, MS3472, MS3474, MS3475, MS3476, MIL-C-83723 Series II, Class A and L. MIL-C-83723, /14, /36, /37, /38, /39, /40, /41, /42, /43, /48, /49, /65, /66, /67, /68, /69, /70, /71, /72, /73, /74, /75, /76, /77, /78, /82, /83, /84, /85, /86, /87, /91, /92, /95, /97, and /98 Connectors, MS3155 controlled interfaces.
- These dimensions apply if a self-locking coupling nut is used, modification code "S".

Table II

Entry Size	Ø Z +0.25/-0.50 [+0.010/-0.020]	Ø S ±0.51 [±0.020]	Ø Y ±0.38 [±0.015]	E Max.
03	4.75 0.188	7.92 0.312	11.10 0.438	16.3 0.64
04	6.35 0.250	9.52 0.375	12.70 0.500	16.3 0.64
05	7.92 0.312	11.12 0.438	14.30 0.563	17.3 0.68
06	9.52 0.375	12.70 0.500	15.88 0.625	17.8 0.70
07	11.12 0.438	14.30 0.562	17.50 0.689	18.8 0.74
08	12.70 0.500	15.88 0.625	19.05 0.750	19.8 0.78
09	14.30 0.562	17.50 0.688	20.65 0.813	20.3 0.80
10	15.88 0.625	19.05 0.750	22.23 0.875	20.8 0.82
11	17.50 0.688	20.65 0.812	23.80 0.938	21.8 0.86
12	19.05 0.750	22.23 0.875	25.40 1.000	22.9 0.90
13	20.65 0.812	23.83 0.938	27.00 1.063	23.9 0.94
14	22.23 0.875	25.40 1.000	30.16 1.189	24.4 0.96

Table II (Continued)

Entry Size	Ø Z +0.25/-0.50 [+0.010/-0.020]	Ø S ±0.51 [±0.020]	Ø Y ±0.38 [±0.015]	E Max.
15	23.83 0.938	27.00 1.062	31.75 1.250	24.9 0.98
16	25.40 1.000	28.58 1.125	33.34 1.313	25.9 1.02
18	28.58 1.125	31.75 1.250	36.51 1.438	28.3 1.11
20	31.75 1.250	34.90 1.375	39.69 1.563	29.8 1.17
22	34.90 1.375	38.10 1.500	42.86 1.688	31.3 1.23
24	38.10 1.500	41.28 1.625	46.83 1.844	33.8 1.33
26	41.28 1.625	44.45 1.750	49.61 1.953	35.1 1.38
28	44.45 1.750	47.63 1.875	52.78 2.078	36.3 1.43
30	47.65 1.875	50.80 2.000	56.36 2.219	37.8 1.49
32	50.80 2.000	54.00 2.125	59.53 2.344	39.6 1.56
34	54.00 2.125	57.15 2.250	62.71 2.469	41.1 1.62

Spin-Coupling Adapters

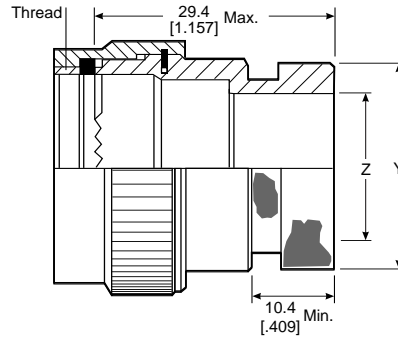

Table of Dimensions

Order No.	Shell Size	Thread	Dimensions	
			Y Max.	Z Min.
08	8	.438-28 UNEF	13.54 [0.53]	6.9 [0.27]
10	10	.562-24 UNEF	15.37 [0.61]	9.9 [0.39]
12	12	.688-24 UNEF	19.66 [0.77]	13.4 [0.53]
14	14	.812-20 UNEF	21.29 [0.84]	15.9 [0.63]
16	16	.938-20 UNEF	24.47 [0.96]	18.9 [0.74]
18	18	1.062-18 UNEF	26.47 [1.04]	21.4 [0.84]
20	20	1.188-18 UNEF	30.92 [1.22]	23.9 [0.94]
22	22	1.312-18 UNEF	34.42 [1.36]	27.4 [1.08]
24	24	1.438-18 UNEF	36.40 [1.44]	29.9 [1.18]

Molded Part Selection Guide (Spin-Coupling)

Order No.	Standard K Parts			Low-Profile D Parts		
	Straight Part No.	90° Part No.	Cable OD (Min.)	Straight Part No.	90° Part No.	Cable OD (Min.)
03, 08	202W232	—	4.3 [0.19]	—	—	—
03, 08	202K121	222K121	5.6 [0.22]	202D211	222D211	6.4 [0.25]
10, 11	202K132	222K132	5.9 [0.23]	202D221	222D221	7.4 [0.29]
12, 14	202K142	222K142	7.1 [0.28]	202D232	222D232	8.4 [0.33]
16, 18	202K153	222K152	8.4 [0.33]	202D242	222D242	9.7 [0.38]
20, 22	202K163	222K163	9.9 [0.39]	202D253	222D253	10.5 [0.41]
24, 28,	202K174	222K174	15.7 [0.62]	202D263	222D263	12.2 [0.48]
32, 36	202K185	222K185	16.8 [0.66]	202D274	222D274	14.3 [0.56]

Uniboot Parts

Order No.	Part No.	Cable OD (Min.)
03, 08	202C611	4.8 [0.19]
10, 11, 12	202C621	8.1 [0.32]
14, 16	202C632	12.7 [0.50]
18, 20	202C642	17.5 [0.69]
22, 24	202C653	22.4 [0.88]

Available in:	Americas	Europe	Asia Pacific
	■	■	■

Tinel-Lock Adapters

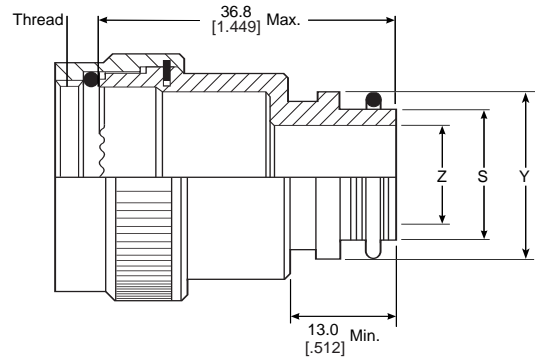

TXR76XX00-XXXXXX

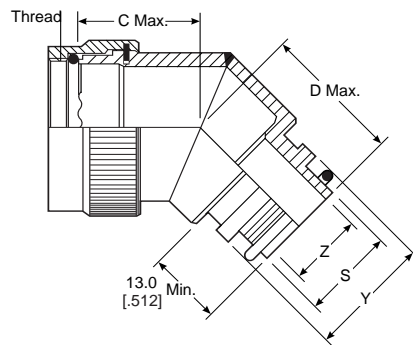

TXR76XX45-XXXXXX

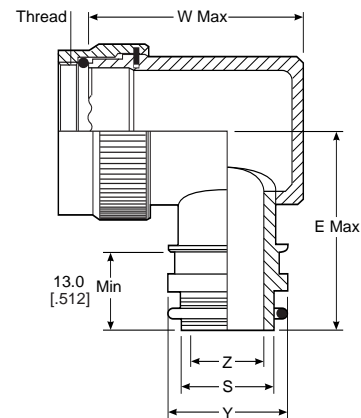

TXR76XX90-XXXXXX

Table of Dimensions

Order No.	Shell Size	Max. Entry Size Type 1*	Thread	Dimensions		
				C Max.	D Max.	E Max.
08	8	04	.438-28 UNEF	18.0 [.74]	21.3 [.87]	26.7 [1.05]
10	10	07	.562-24 UNEF	18.8 [.76]	22.1 [.90]	28.2 [1.11]
12	12	08	.688-24 UNEF	19.3 [.79]	22.9 [.92]	30.2 [1.19]
14	14	10	.812-20 UNEF	20.1 [.82]	23.4 [.95]	31.8 [1.25]
16	16	12	.938-20 UNEF	20.8 [.84]	24.1 [.97]	33.5 [1.32]
18	18	12	1.062-18 UNEF	21.3 [.87]	24.6 [1.00]	35.1 [1.38]
20	20	16	1.188-18 UNEF	22.1 [.89]	25.4 [1.02]	36.6 [1.44]
22	22	18	1.312-18 UNEF	22.6 [.92]	25.9 [1.05]	38.1 [1.50]
24	24	20	1.438-18 UNEF	23.4 [.97]	26.7 [1.07]	39.4 [1.55]

*For larger than maximum type 1 entry sizes, a two-piece adapter will be supplied. Contact Tyco Electronics for information.

Available in:	Americas	Europe	Asia Pacific
	■	■	■

Tinel-Lock Adapters
(continued)

Entry Size Dimensions

Entry Size	Dimensions			
	Z +0.25-0.5	S Diameter (Min.-Max.)	Y ±0.38	W Max.
04	6.35 [0.25]	9.39—9.56 [0.37—0.38]	13.97 [1.22]	31.0 [0.55]
05	7.92 [0.31]	10.97—11.13 [0.43—0.44]	15.54 [1.29]	32.8 [0.61]
06	9.52 [0.37]	12.57—12.73 [0.49—0.50]	17.14 [1.35]	34.3 [0.67]
07	11.09 [0.44]	14.12—14.31 [0.55—0.56]	18.71 [1.41]	35.8 [0.74]
08	12.7 [0.50]	15.72—15.91 [0.62—0.63]	20.32 [1.47]	37.3 [0.80]
10	15.87 [0.62]	18.84—19.11 [0.74—0.75]	23.49 [1.60]	40.6 [0.92]
12	19.05 [0.75]	22.02—22.28 [0.87—0.88]	26.67 [1.72]	43.7 [1.05]
14	22.23 [0.88]	25.17—25.46 [0.99—1.00]	29.84 [1.85]	47.0 [1.17]
16	25.4 [1.00]	28.34—28.63 [1.12—1.13]	33.02 [1.97]	50.0 [1.30]
18	28.57 [1.12]	31.52—31.81 [1.24—1.25]	36.19 [2.10]	53.3 [1.42]
20	31.75 [1.25]	34.69—34.98 [1.37—1.38]	39.37 [1.55]	53.8 [2.19]

Molded Part Selection Guide
(Tinel)

Tinel-Lock Entry Size	Standard K Parts			Low-Profile D Parts		
	Straight Part No.	90° Part No.	Cable OD (Min.)	Straight Part No.	90° Part No.	Cable OD (Min.)
04	202K232	—	3.3 [0.1]	—	—	—
04	202W232	—	4.3 [0.2]	—	—	—
04	202K121	222K121	5.6 [0.2]	202D211	222D211	6.4 [0.3]
05, 06	202K132	222K132	5.9 [0.2]	202D221	222D221	7.4 [0.3]
07, 08	202K142	222K142	7.1 [0.3]	202D232	222D232	8.4 [0.3]
10, 12	202K153	222K152	8.4 [0.3]	202D242	222D242	9.7 [0.4]
14, 16	202K163	222K163	9.9 [0.4]	202D253	222D253	10.5 [0.4]
18, 20, 22	202K174	222K174	15.7 [0.6]	202D263	222D263	12.2 [0.5]
24	202K185	222K185	16.8 [0.7]	—	—	—

Uniboot Parts

Tinel-Lock Entry Size	Part No.	Cable OD (Min.)
04	202C611	4.8 [0.19]
05, 06, 07	202C621	8.1 [0.32]
08, 10, 12	202C632	12.7 [0.50]
12, 14, 16	202C642	17.5 [0.69]
16, 18, 20, 22	202C653	22.4 [0.88]
24	202C663	22.9 [0.90]

Raychem assemblies and kits fit a wide variety of applications.

KTKK assemblies are available with Rayaten screened molded parts, to suit a wide range of connectors. For correct part number referencing, please contact Tyco Electronics.

Unscreened versions are available as well.

TCFS/R feedthroughs are also available, both with Rayaten screened molded parts or in unscreened versions.

Raychem's KTKK and TCFS/R product families come with the added advantage of preinstalled adhesives, which can drastically reduce the installation time and cost of harness building.

SESK shipboard electrical splice kits can be used to splice multiconductor cables in new ship construction, allowing modular wiring techniques and use of existing wiring when jumbo-sizing commercial ships.

Ship-to-shore kits are used to bring shore power to a ship in dock.

Table of Contents**Assemblies**

KTKK Product Family Overview	7-2
KTKK Assemblies Screened	7-3 to 7-5

Feedthroughs

TCFS/R Cable Feedthroughs	7-6 to 7-8
---------------------------------	------------

Preinstalled Adhesives

S-1030, S-1048, S-1275 (Rayaten) Preinstalled Adhesives	7-9
---	-----

Kits

SESK Shipboard Electrical Splice Kits	7-10 to 7-12
Ship or Shore Breakout Kits	7-13

Note: Users should independently evaluate the suitability of the product for their application. Before ordering, check with Tyco Electronics for most current data.

Applications



KTKK cable assemblies are one-part assemblies for screened and unscreened cables. Constructed from Raychem heat-shrinkable screened molded parts and connector adapters, the assembly consists of parts already well proven in harsh military environments.

Installation is simply effected by coupling the adapter to the connector and shrinking the rear of the molded part onto the cable with a hot air gun.

The molded part has a hot-melt adhesive pre-installed to provide a bond between the cable jacket and the molded part.

When used in conjunction with shielded (screened) cables, the assembly provides electrical continuity between the cable shield and the connector with Rayaten molded parts.

Rayaten molded parts are shielded, heat-shrinkable parts providing shielding levels better than 80 dB at 100 MHz.

Assembly Types



Straight Assemblies

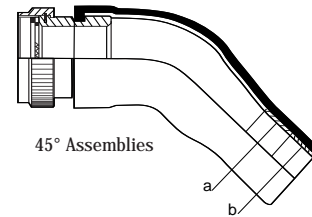

45° Assemblies

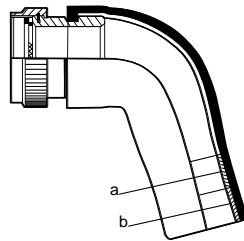

90° Assemblies

a = Preinstalled conductive adhesive for use with Rayaten screened molded parts only.

b = Preinstalled environment adhesive for use with screened and unscreened KTKK assemblies (see "Preinstalled adhesives," page 7-9).

Materials Available

Material		Specification
-25 fluid-resistant modified elastomer	-25S fluid-resistant modified elastomer; shielded	RK-6719
-100 low-fire-hazard material	-100S low-fire-hazard; shielded	RK-6724

Precoated Adhesives

Material	Available Coatings (Unshielded)	Available Coatings (Shielded)
-25	S-1048 (/86) high-temperature hot-melt adhesive	—
-25S	—	S-1030 (/180) low-fire-hazard hot-melt adhesive
-100	S-1030 (/180) low-fire-hazard hot-melt adhesive	—
-100S	—	S-1275 conductive adhesive for use with Rayaten molded parts.

Available in:	Americas	Europe	Asia Pacific
	■	■	■

KTKK Assemblies Screened

Pattern 105 Connectors or
Connector Code 76

25S Fluid Resistant Elastomer

Connector Shell Size	Straight Assemblies		45° Assemblies		90° Assemblies		Raychem Part No.	Cable O.D. Range
	Raychem Part No.	Cable O.D. Range	Raychem Part No.	Cable O.D. Range	Raychem Part No.	Cable O.D. Range		
08	KTKK 0520	5.0-8.0 [.197-.315]	KTKK 0560	5.0-7.0 [.197-.276]	—	—	—	—
10	KTKK 0521	6.0-13.0 [.236-.512]	KTKK 0561	6.0-9.0 [.236-.354]	KTKK 1051	6.0-13.0 [.236-.512]	—	—
12	KTKK 0522	7.2-15.0 [.283-.591]	KTKK 0562	7.2-11.0 [.283-.433]	KTKK 1052	7.2-15.0 [.283-.591]	—	—
14	KTKK 0523	7.2-15.0 [.283-.591]	KTKK 0563	7.2-11.0 [.283-.433]	KTKK 1053	7.2-15.0 [.283-.591]	—	—
16	KTKK 0524	8.5-19.0 [.335-.748]	KTKK 0564	8.5-17.0 [.335-.669]	KTKK 1054	8.5-19.0 [.335-.748]	—	—
18	KTKK 0525	8.5-20.0 [.335-.748]	KTKK 0565	8.5-17.0 [.335-.669]	KTKK 1055	8.5-19.0 [.335-.748]	—	—
20	KTKK 0526	10.0-24.0 [.394-.945]	KTKK 0566	10.0-21.0 [.394-.827]	KTKK 1056	10.0-24.0 [.394-.945]	—	—
22	KTKK 0527	10.0-24.0 [.394-.945]	KTKK 0567	10.0-21.0 [.394-.827]	KTKK 1057	10.0-24.0 [.394-.945]	—	—
24	KTKK 0528	15.8-33.0 [.622-1.299]	KTKK 0568	15.8-29.0 [.622-1.142]	KTKK 1058	15.8-33.0 [.622-1.299]	—	—

100S Low Fire Hazard Material

08	KTKK 0465	5.0-7.0 [.197-.276]	KTKK 0603	5.0-7.0 [.197-.276]	—	—	—	—
10	KTKK 0466	6.0-9.0 [.236-.354]	KTKK 0604	6.0-9.0 [.236-.354]	KTKK 1251	6.0-9.0 [.236-.354]	—	—
12	KTKK 0467	7.2-11.0 [.283-.433]	KTKK 0605	7.2-11.0 [.283-.433]	KTKK 1252	7.2-11.0 [.283-.433]	—	—
14	KTKK 0468	7.2-11.0 [.283-.433]	KTKK 0606	7.2-11.0 [.283-.433]	KTKK 1253	7.2-11.0 [.283-.433]	—	—
16	KTKK 0469	8.5-17.0 [.335-.669]	KTKK 0607	8.5-17.0 [.335-.669]	KTKK 1254	8.5-17.0 [.335-.669]	—	—
18	KTKK 0470	8.5-17.0 [.335-.669]	KTKK 0608	8.5-17.0 [.335-.669]	KTKK 1255	8.5-17.0 [.335-.669]	—	—
20	KTKK 0471	10.0-21.0 [.394-.827]	KTKK 0609	10.0-21.0 [.394-.827]	KTKK 1256	10.0-21.0 [.394-.827]	—	—
22	KTKK 0472	10.0-21.0 [.394-.827]	KTKK 0610	10.0-21.0 [.394-.827]	KTKK 1257	10.0-21.0 [.394-.827]	—	—
24	KTKK 0473	15.8-29.0 [.622-1.142]	KTKK 0611	15.8-29.0 [.622-1.142]	KTKK 1258	15.8-29.0 [.622-1.142]	—	—

Pattern 602 Connectors or
Connector Code 54

25S Fluid Resistant Elastomer

Connector Shell Size	Straight Assemblies		45° Assemblies		90° Assemblies		Raychem Part No.	Cable O.D. Range
	Raychem Part No.	Cable O.D. Range	Raychem Part No.	Cable O.D. Range	Raychem Part No.	Cable O.D. Range		
08	KTKK 0840	5.0-8.0 [.197-.315]	KTKK 0970	5.0-7.0 [.197-.276]	—	—	—	—
10	KTKK 0841	6.0-13.0 [.236-.512]	KTKK 0971	6.0-9.0 [.236-.354]	KTKK 0851	6.0-13.0 [.236-.512]	—	—
12	KTKK 0842	7.2-15.0 [.283-.591]	KTKK 0972	7.2-11.0 [.283-.433]	KTKK 0852	7.2-15.0 [.283-.591]	—	—
14	KTKK 0843	7.2-15.0 [.283-.591]	KTKK 0973	7.2-11.0 [.283-.433]	KTKK 0853	7.2-15.0 [.283-.591]	—	—
16	KTKK 0844	8.5-19.0 [.335-.748]	KTKK 0974	8.5-17.0 [.335-.669]	KTKK 0854	8.5-19.0 [.335-.748]	—	—
18	KTKK 0845	8.5-19.0 [.335-.748]	KTKK 0975	8.5-17.0 [.335-.669]	KTKK 0855	8.5-19.0 [.335-.748]	—	—
20	KTKK 0846	10.0-24.0 [.394-.945]	KTKK 0976	10.0-21.0 [.394-.827]	KTKK 0856	10.0-24.0 [.394-.945]	—	—
22	KTKK 0847	10.0-24.0 [.394-.945]	KTKK 0977	10.0-21.0 [.394-.827]	KTKK 0857	10.0-24.0 [.394-.945]	—	—
24	KTKK 0848	15.8-33.0 [.622-1.299]	KTKK 0978	15.8-29.0 [.622-1.142]	KTKK 0858	15.8-33.0 [.622-1.299]	—	—

100S Low Fire Hazard Material

08	KTKK 0612	5.0-7.0 [.197-.276]	KTKK 0780	5.0-7.0 [.197-.276]	—	—	—	—
10	KTKK 0613	6.0-9.0 [.236-.354]	KTKK 0781	6.0-9.0 [.236-.354]	KTKK 1241	6.0-9.0 [.236-.354]	—	—
12	KTKK 0614	7.2-11.0 [.283-.433]	KTKK 0782	7.2-11.0 [.283-.433]	KTKK 1242	7.2-11.0 [.283-.433]	—	—
14	KTKK 0615	7.2-11.0 [.283-.433]	KTKK 0783	7.2-11.0 [.283-.433]	KTKK 1243	7.2-11.0 [.283-.433]	—	—
16	KTKK 0616	8.5-17.0 [.335-.669]	KTKK 0784	8.5-17.0 [.335-.669]	KTKK 1244	8.5-17.0 [.335-.669]	—	—
18	KTKK 0617	8.5-17.0 [.335-.669]	KTKK 0785	8.5-17.0 [.335-.669]	KTKK 1245	8.5-17.0 [.335-.669]	—	—
20	KTKK 0618	10.0-21.0 [.394-.827]	KTKK 0786	10.0-21.0 [.394-.827]	KTKK 1246	10.0-21.0 [.394-.827]	—	—
22	KTKK 0619	10.0-21.0 [.394-.827]	KTKK 0787	10.0-21.0 [.394-.827]	KTKK 1247	10.0-21.0 [.394-.827]	—	—
24	KTKK 0620	15.8-29.0 [.622-1.142]	KTKK 0788	15.8-29.0 [.622-1.142]	KTKK 1248	15.8-29.0 [.622-1.142]	—	—

KTKK Assemblies Screened (Continued)

Pattern 608 Connectors or Connector Code 79

25S Fluid Resistant Elastomer

Connector Shell Size	Straight Assemblies		45° Assemblies		90° Assemblies	
	Raychem Part No.	Cable O.D. Range	Raychem Part No.	Cable O.D. Range	Raychem Part No.	Cable O.D. Range
08	KTKK 0530	5.0-8.0 [.197-.315]	KTKK 0540	5.0-7.0 [.197-.276]	—	—
10	KTKK 0531	6.0-13.0 [.236-.512]	KTKK 0541	6.0-9.0 [.236-.354]	KTKK 1261	6.0-13.0 [.236-.512]
12	KTKK 0532	7.2-15.0 [.283-.591]	KTKK 0542	7.2-11.0 [.283-.433]	KTKK 1262	7.2-15.0 [.283-.591]
14	KTKK 0533	7.2-15.0 [.283-.591]	KTKK 0543	7.2-11.0 [.283-.433]	KTKK 1263	7.2-15.0 [.283-.591]
16	KTKK 0534	8.5-19.0 [.335-.748]	KTKK 0544	8.5-17.0 [.335-.669]	KTKK 1264	8.5-19.0 [.335-.748]
18	KTKK 0535	8.5-19.0 [.335-.748]	KTKK 0545	8.5-17.0 [.335-.669]	KTKK 1265	8.5-19.0 [.335-.748]
20	KTKK 0536	10.0-24.0 [.394-.945]	KTKK 0546	10.0-21.0 [.394-.827]	KTKK 1266	10.0-24.0 [.394-.945]
22	KTKK 0537	10.0-24.0 [.394-.945]	KTKK 0547	10.0-21.0 [.394-.827]	KTKK 1267	10.0-24.0 [.394-.945]
24	KTKK 0538	15.8-33.0 [.622-1.299]	KTKK 0548	15.8-29.0 [.622-1.142]	KTKK 1268	15.8-33.0 [.622-1.299]

100S Low Fire Hazard Material

08	KTKK 0444	5.0-7.0 [.197-.276]	KTKK 0580	5.0-7.0 [.197-.276]	—	—
10	KTKK 0445	6.0-9.0 [.236-.354]	KTKK 0581	6.0-9.0 [.236-.354]	KTKK 1021	6.0-9.0 [.236-.512]
12	KTKK 0446	7.2-11.0 [.283-.433]	KTKK 0582	7.2-11.0 [.283-.433]	KTKK 1022	7.2-11.0 [.283-.591]
14	KTKK 0447	7.2-11.0 [.283-.433]	KTKK 0583	7.2-11.0 [.283-.433]	KTKK 1023	7.2-11.0 [.283-.591]
16	KTKK 0448	8.5-17.0 [.335-.669]	KTKK 0584	8.5-17.0 [.335-.669]	KTKK 1024	8.5-17.0 [.335-.748]
18	KTKK 0449	8.5-17.0 [.335-.669]	KTKK 0585	8.5-17.0 [.335-.669]	KTKK 1025	8.5-17.0 [.335-.748]
20	KTKK 0450	10.0-21.0 [.394-.827]	KTKK 0586	10.0-21.0 [.394-.827]	KTKK 1026	10.0-21.0 [.394-.827]
22	KTKK 0451	10.0-21.0 [.394-.827]	KTKK 0587	10.0-21.0 [.394-.827]	KTKK 1027	10.0-21.0 [.394-.827]
24	KTKK 0452	15.8-29.0 [.622-1.142]	KTKK 0588	15.8-29.0 [.622-1.142]	KTKK 1028	15.8-29.0 [.622-1.142]

38999 Series III and IV Connectors or Connector Code 40

25S Fluid Resistant Elastomer

Connector Shell Size	Straight Assemblies		45° Assemblies		90° Assemblies	
	Raychem Part No.	Cable O.D. Range (mm)	Raychem Part No.	Cable O.D. Range (mm)	Raychem Part No.	Cable O.D. Range (mm)
08	KTKK 1110	5.0-8.0 [.197-.315]	KTKK 1120	5.0-7.0 [.197-.276]	—	—
10	KTKK 1111	6.0-13.0 [.236-.512]	KTKK 1121	6.0-9.0 [.236-.354]	KTKK 1131	6.0-13.0 [.236-.512]
12	KTKK 1112	7.2-15.0 [.283-.591]	KTKK 1122	7.2-11.0 [.283-.433]	KTKK 1132	7.2-15.0 [.283-.591]
14	KTKK 1113	7.2-15.0 [.283-.591]	KTKK 1123	7.2-11.0 [.283-.433]	KTKK 1133	7.2-15.0 [.283-.591]
16	KTKK 1114	8.5-19.0 [.335-.748]	KTKK 1124	8.5-17.0 [.335-.669]	KTKK 1134	8.5-19.0 [.335-.748]
18	KTKK 1115	8.5-19.0 [.335-.748]	KTKK 1125	8.5-17.0 [.335-.669]	KTKK 1135	8.5-19.0 [.335-.748]
20	KTKK 1116	10.0-24.0 [.394-.945]	KTKK 1126	10.0-21.0 [.394-.827]	KTKK 1136	10.0-24.0 [.394-.945]
22	KTKK 1117	10.0-24.0 [.394-.945]	KTKK 1127	10.0-21.0 [.394-.827]	KTKK 1137	10.0-24.0 [.394-.945]
24	KTKK 1118	15.8-33.0 [.622-1.299]	KTKK 1128	15.8-29.0 [.622-1.142]	KTKK 1138	15.8-33.0 [.622-1.299]

100S Low Fire Hazard Material

08	KTKK 0670	5.0-7.0 [.197-.276]	KTKK 0660	5.0-7.0 [.197-.276]	—	—
10	KTKK 0671	6.0-9.0 [.236-.354]	KTKK 0661	6.0-9.0 [.236-.354]	KTKK 1181	6.0-9.0 [.236-.354]
12	KTKK 0672	7.2-11.0 [.283-.433]	KTKK 0662	7.2-11.0 [.283-.433]	KTKK 1182	7.2-11.0 [.283-.433]
14	KTKK 0673	7.2-11.0 [.283-.433]	KTKK 0663	7.2-11.0 [.283-.433]	KTKK 1183	7.2-11.0 [.283-.433]
16	KTKK 0674	8.5-17.0 [.335-.669]	KTKK 0664	8.5-17.0 [.335-.669]	KTKK 1184	8.5-17.0 [.335-.669]
18	KTKK 0675	8.5-17.0 [.335-.669]	KTKK 0665	8.5-17.0 [.335-.669]	KTKK 1185	8.5-17.0 [.335-.669]
20	KTKK 0676	10.0-21.0 [.394-.827]	KTKK 0666	10.0-21.0 [.394-.827]	KTKK 1186	10.0-21.0 [.394-.827]
22	KTKK 0677	10.0-21.0 [.394-.827]	KTKK 0667	10.0-21.0 [.394-.827]	KTKK 1187	10.0-21.0 [.394-.827]
24	KTKK 0678	15.8-29.0 [.622-1.142]	KTKK 0668	15.8-29.0 [.622-1.142]	KTKK 1188	15.8-29.0 [.622-1.142]

38999 Series I and II
Connectors or Connector
Code 41

25S Fluid Resistant Elastomer

KTKK Assemblies Screened (Continued)

Connector Shell Size	Straight Assemblies		45° Assemblies		90° Assemblies		Raychem Part No.	Cable O.D. Range
	Raychem Part No.	Cable O.D. Range	Raychem Part No.	Cable O.D. Range	Raychem Part No.	Cable O.D. Range		
08	KTKK 0500	5.0-8.0 [.197-.315]	KTKK 0510	5.0-7.0 [.197-.276]	—	—		
10	KTKK 0501	6.0-13.0 [.236-.512]	KTKK 0511	6.0-9.0 [.236-.354]	KTKK 0831	6.0-13.0 [.236-.512]		
12	KTKK 0502	7.2-15.0 [.283-.591]	KTKK 0512	7.2-11.0 [.283-.433]	KTKK 0832	7.2-15.0 [.283-.591]		
14	KTKK 0503	7.2-15.0 [.283-.591]	KTKK 0513	7.2-11.0 [.283-.433]	KTKK 0833	7.2-15.0 [.283-.591]		
16	KTKK 0504	8.5-19.0 [.335-.748]	KTKK 0514	8.5-17.0 [.335-.669]	KTKK 0834	8.5-19.0 [.335-.748]		
18	KTKK 0505	8.5-19.0 [.335-.748]	KTKK 0515	8.5-17.0 [.335-.669]	KTKK 0835	8.5-19.0 [.335-.748]		
20	KTKK 0506	10.0-24.0 [.394-.945]	KTKK 0516	10.0-21.0 [.394-.827]	KTKK 0836	10.0-24.0 [.394-.945]		
22	KTKK 0507	10.0-24.0 [.394-.945]	KTKK 0517	10.0-21.0 [.394-.827]	KTKK 0837	10.0-24.0 [.394-.945]		
24	KTKK 0508	15.8-33.0 [.622-1.299]	KTKK 0518	15.8-29.0 [.622-1.142]	KTKK 0838	15.8-33.0 [.622-1.299]		

100S Low Fire Hazard Material

08	KTKK 0640	5.0-7.0 [.197-.276]	KTKK 0630	5.0-7.0 [.197-.276]	—	—		
10	KTKK 0641	6.0-9.0 [.236-.354]	KTKK 0631	6.0-9.0 [.236-.354]	KTKK 0721	6.0-9.0 [.236-.354]		
12	KTKK 0642	7.2-11.0 [.283-.433]	KTKK 0632	7.2-11.0 [.283-.433]	KTKK 0722	7.2-11.0 [.283-.433]		
14	KTKK 0643	7.2-11.0 [.283-.433]	KTKK 0633	7.2-11.0 [.283-.433]	KTKK 0723	7.2-11.0 [.283-.433]		
16	KTKK 0644	8.5-17.0 [.335-.669]	KTKK 0634	8.5-17.0 [.335-.669]	KTKK 0724	8.5-17.0 [.335-.669]		
18	KTKK 0645	8.5-17.0 [.335-.669]	KTKK 0635	8.5-17.0 [.335-.669]	KTKK 0725	8.5-17.0 [.335-.669]		
20	KTKK 0646	10.0-21.0 [.394-.827]	KTKK 0636	10.0-21.0 [.394-.827]	KTKK 0726	10.0-21.0 [.394-.827]		
22	KTKK 0647	10.0-21.0 [.394-.827]	KTKK 0637	10.0-21.0 [.394-.827]	KTKK 0727	10.0-21.0 [.394-.827]		
24	KTKK 0648	15.8-29.0 [.622-1.142]	KTKK 0638	15.8-29.0 [.622-1.142]	KTKK 0728	15.8-29.0 [.622-1.142]		

Product Facts

- Screened or unshielded cables
- One-piece part
- Each size covers a wide cable range
- Light weight
- Single- or double-sided assembly

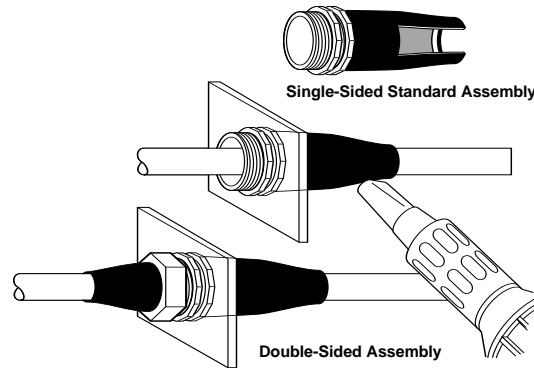

Applications

Provides environmental sealing and screen continuity to a bulkhead as a cable passes through. The assembly consists of a specifically designed locknut and O-ring seal, onto the rear of which is pre-installed a Raychem heat-shrinkable molded part. Feedthrough installation is simply effected by tightening the locknut on the rear of the bulkhead, which compresses the O-ring and ensures that a small knife-edge provides electrical contact between the assembly and the bulkhead.

When heat is applied to the molded part in the form of hot air, a seal to the cable is formed with hot-melt adhesive. When specified for screened cables, the assembly contains a conductive adhesive, which provides electrical continuity between the screen and the bulkhead via Rayaten molded parts.

These molded parts are shielded (screened), heat-shrinkable parts providing shielding levels better than 80 dB at 100 MHz.

Available in:	Americas	Europe	Asia Pacific
	■	■	■

Part Numbering System

TCFX* - 12 62C - 0 - 20 - 100 A H

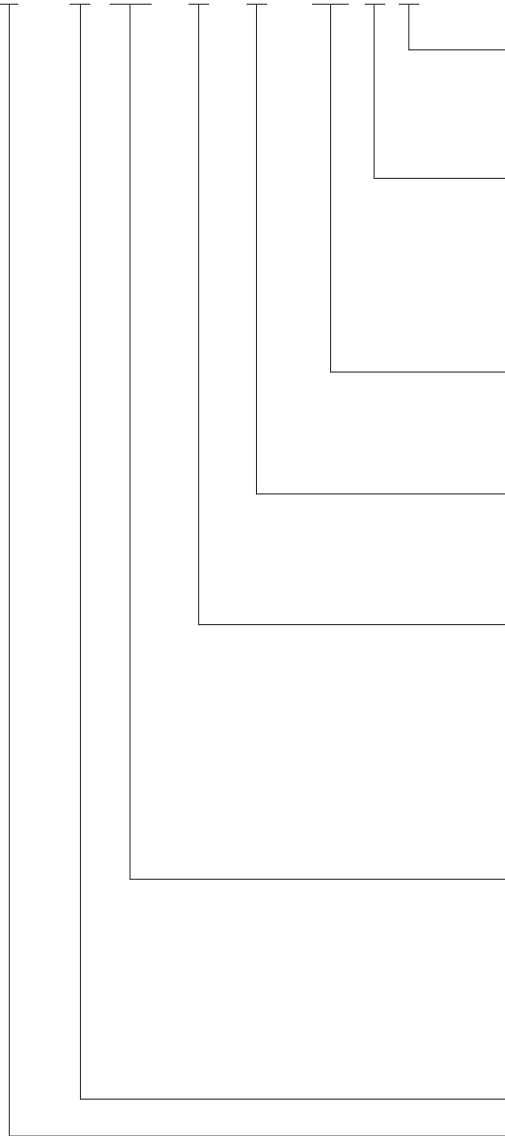

Adhesive System

E = Epoxy (consult factory)
 H = S-1030 hot melt
 W = S-1048 hot melt

Molded Part Type

A = Straight unscreened
 B = 90° unscreened
 C = Straight screened
 D = 45° screened
 E = 90° screened (16–36 only)

Molded Part Material

-25 = Semirigid elastomer
 -100 = Low fire hazard

Thread Length

(may be three digits if more than 95 mm required)
 20 mm standard
 5 mm increments, minimum 15 mm

Assembly Modification Code

0 = Standard assembly
 1 = Double-sided assembly (only straight unshielded boot available on double nut)
 2 = Same as 1 but with potting ports
 3 = Locknut
 4 = 60° metalwork
 5 = Same as 0 but with potting ports

Feedthrough Material/Finish

01W = Nickel aluminium bronze, shotblast
 19B = Aluminium-alloy-plated cadmium, olive drab, over electroless nickel
 19C = Aluminium-alloy-plated electroless nickel
 19Q = Aluminium-alloy-plated zinc cobalt
 62C = Stainless-steel-plated electroless nickel

Feedthrough Size

Part Description

TCFS uses a full-length molded part
 TCFR uses a shortened molded part (only available on straight assemblies)

*See Molded Parts Materials Section 4 for -25 and -100 information.

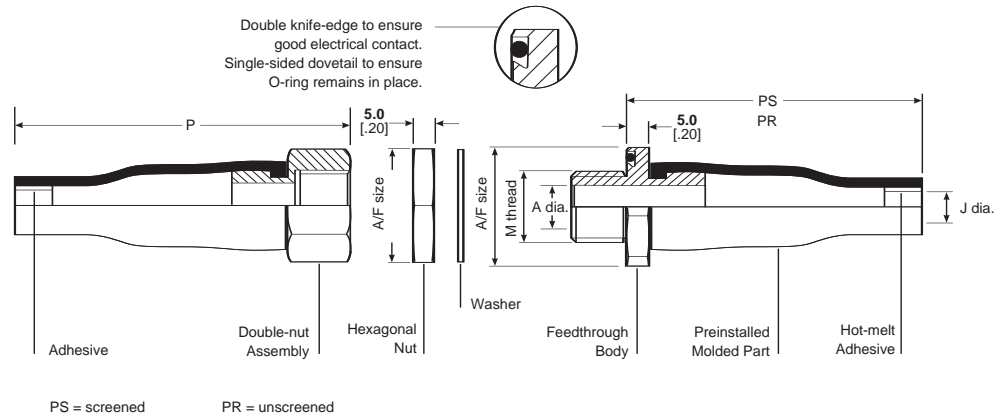

Product Dimensions

Feed-through Size	J Diameter*					M Thread	A Dia. Max.	A/F Body	A/F Nut	P ±10% Unscreened			Hole Size
	Unshielded		Shielded							P	PS	PR	
	a Min.	b Max.	a Min. -25S	-100S	b Max.								
TCFS/R-12	11 [.43]	5.6 [.22]	7.5 [.30]	6.5 [.26]	5.0 [.20]	M12 x 1.5	7.5 [.30]	24 [.95]	17 [.67]	52	50	43	13.0 [.51]
TCFS/R-16	15 [.59]	5.9 [.23]	12.5 [.49]	8.5 [.33]	6.0 [.24]	M16 x 1.5	10.2 [.40]	29 [1.14]	22 [.87]	57	65	48	17.0 [.67]
TCFS/R-20	19 [.75]	7.1 [.28]	14.5 [.57]	10.5 [.41]	7.2 [.28]	M20 x 1.5	14.0 [.55]	34 [1.34]	27 [1.06]	61	77	52	21.0 [.83]
TCFS/R-24	23 [.90]	8.4 [.33]	18.5 [.73]	16.5 [.65]	8.5 [.33]	M24 x 1.5	19.2 [.76]	38 [1.50]	30 [1.18]	74	90	65	25.0 [.98]
TCFS/R-30	29 [1.14]	9.9 [.39]	23.5 [.93]	20.5 [.81]	10.0 [.39]	M30 x 1.5	24.2 [.95]	48 [1.89]	36 [1.48]	73	115	64	31.0 [1.22]
TCFS/R-36	35 [1.38]	15.7 [.62]	32.5 [1.28]	28.5 [1.12]	15.8 [.62]	M36 x 1.5	30.2 [1.49]	52 [2.05]	41 [1.61]	104	140	95	37.0 [1.46]
TCFR-48	45 [1.77]	16.8 [.66]	38.5 [1.52]	35.5 [1.40]	N/A	M48 x 1.5	40.2 [1.58]	67 [2.64]	55 [2.17]	144	110	135	50.0 [1.97]

*a = Supplied dimension
b = Dimension after free recovery

Product Characteristics



Preinstalled Adhesives

S-1030, S-1048, S-1275 (Rayaten)

S-1030 Polyolefin Hot-Melt Adhesive

Precoat designation	/180
Type	Polyolefin hot-melt adhesive
Operating temperature range	-80°C to 80°C [-112°F to 176°F]
Bonding temperature	120°C [248°F]
Minimum shelf life at or below 25°C	4 years
Specification	RK-6017, RT-1050/6
Comments	Excellent water blocking and low temperature

S-1048 High-Performance Hot-Melt Adhesive

Precoat designation	/86
Type	High-performance hot-melt adhesive
Operating temperature range	-55°C to 120°C [-67°F to 248°F]
Bonding temperature	160°C [320°F]
Minimum shelf life at or below 25°C	4 years
Specification	RK-6626, RT-1050/3
Comments	Good solvent resistance but requires higher temperature to achieve bonding

S-1275 Rayaten Conductive Adhesive* (for KTKK assemblies only)

Type	Electrically conductive polyamide hot-melt adhesives
Operating temperature range	-40°C to 70°C [-40°F to 158°F]
Bonding temperature	160°C [320°F]
Minimum shelf life at or below 25°C	2 years
Specification	RK-6637
Comments	Conductive adhesive for use with Rayaten parts

*Not sold separately.

Available in:	Americas	Europe	Asia Pacific
	■	■	■

Product Facts

- Waterproofing and corrosion proofing
- Standard sizes that cover most single-, two-, three-, four-, and multi-conductor cables
- Excellent electrical-insulation properties and abrasion protection
- Easy installation
- Operating temperature range of -55°C to +90°C [-67°F to +194°F]
- Approved for new ship construction



Kits

SESK — Shipboard Electrical Splice Kits



Applications

SESK kits provide fast, waterproof repair of single-, two-, three-, four-, and multi-conductor cables. Kits are suitable for both permanent and temporary repairs. The self-sealing heat-shrinkable tubing used in each kit provides a watertight seal for the inner insulation and outer jacket. The flame-retardant tubing material provides electrical and thermal properties similar to those of most Navy standard cables.

Installation

Minimum shrink temperature: 121°C [250°F]

Specifications/Approvals

Series	Military	Industry	Agency	Raychem
SESK	MIL-DTL-23053*	IEEE-383 Massive Flame Vertical Tray Test	Lloyd's Register	—
	USCG CGHQ-3774	SST-FR	DNV	—
	U.S. Navy drawing 5001027-19	RW-2011	ABS	—
Tubing used to replace cable jacket	SST-FR	SST-FR	—	Sigmaform FR
	—	—	SST-FR	RW-2011

*Formerly MIL+23053/15A

Available in:	Americas	Europe	Asia Pacific
	■	■	■

SESK — Shipboard Electrical Splice Kits (Continued)

Part No.	Cable Range (Navy Standard)	Approx. AWG Equivalent
Single-Conductor Cable		
SESK S-4	S-4-S-10	#14-#10
SESK S-16	S-16-S-41	#8-#4
SESK S-52	S-52-S-106	#3-#1/0
SESK S-133	S-133-S-250	#2/0-250 mcm
SESK S-300	S-300-S-600	300 mcm-600 mcm
SESK S-650	S-650-S-1000	650 mcm-1000 mcm
Two-Conductor Cable		
SESK D-3	D-3	#22-#16
SESK D-4	D-4-D-10	#14-#10
SESK D-14	D-14	#9
SESK D-23	D-23-D-41	#7-#4
SESK D-50	D-50-D-168	#3-#3/0
SESK D-200	D-200-D-250	#4/0-250 mcm
SESK D-300	D-300-D-350	300 mcm-350 mcm
SESK D-400	D-400-D-450	400 mcm-450 mcm
Three-Conductor Cable		
SESK T-3	T-3	#22-#16
SESK T-4	T-4-T-10	#14-#10
SESK T-14	T-14-T-20	#9-#7
SESK T-23	T-23-T-41	#6-#4
SESK T-50	T-50-T-168	#3/0
SESK T-200	T-200-T-250	#4/0-250 mcm
SESK T-300	T-300-T-350	300 mcm-350 mcm
SESK T-400	T-400-T-450	400 mcm-450 mcm
SESK T-500	T-500-T-600	500 mcm-600 mcm
Four-Conductor Cable		
SESK F-3	F-3	#22-#16
SESK F-4	F-4-F-9	#14-#10
SESK F-23	F-23	#6
SESK F-50	F-50	#3
SESK F-75	F-75-F-100	#1-#1/0
SESK F-150	F-150-F-200	#3/0-#4/0
Multiconductor Cable		
SESK M-2	2	#18-#22
SESK M-4	4	#18-#22
SESK M-6	6	#18-#22
SESK M-8	8	#18-#22
SESK M-10	10	#18-#22
SESK M-12	12	#18-#22
SESK M-14	14	#18-#22
SESK M-16	16	#18-#22
SESK M-18	18	#18-#22
SESK M-20	20	#18-#22
SESK M-22	22	#18-#22
SESK M-24	24	#18-#22
SESK M-26	26	#18-#22
SESK M-28	28	#18-#22
SESK M-30	30	#18-#22
SESK M-32	32	#18-#22

Note: SESK kits are also available for UJIS cables. Contact Tyco Electronics for details.

Part Numbering System

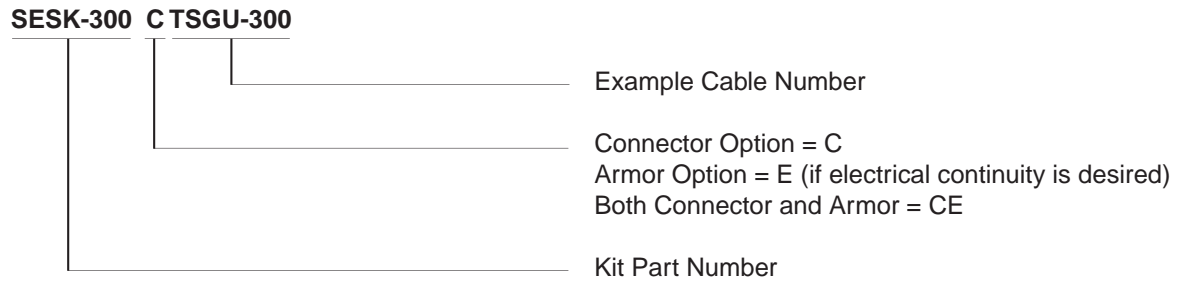

Product Facts

- Heat-shrinkable boot replaces potting or molding
- Flame-retardant tubing has a 3:1 shrink ratio
- Kit offers resistance to moisture, fungus, and weathering
- Operating temperature range of -55°C to +90°C [-67°F to +194°F]



Ship or Shore Breakout Kits

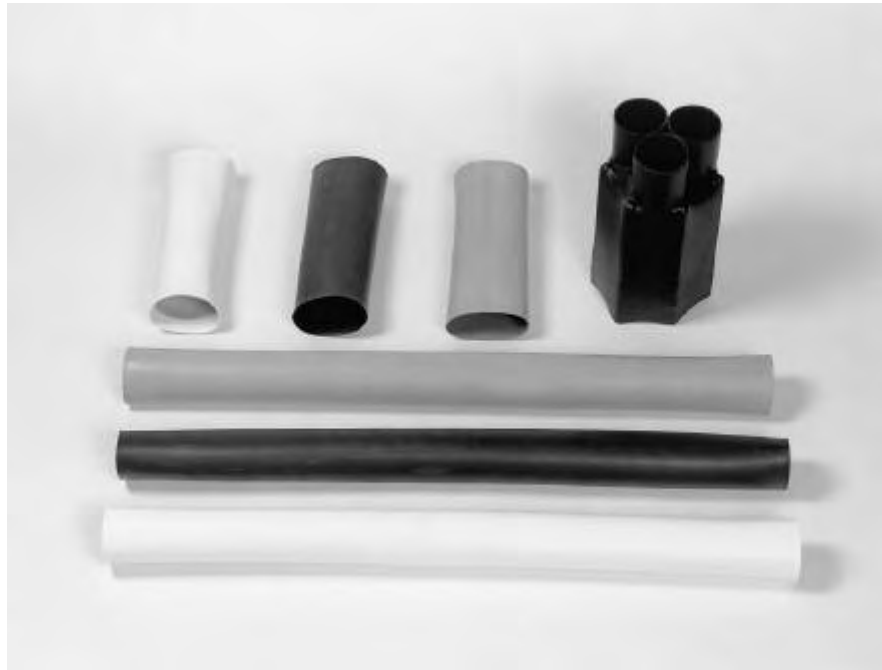

Applications

Waterproof splices for power cables are available in red, white, and black for positive identification of each conductor.

Bolting power cables together and wrapping the splice with tape used to be the accepted method. Now the in-line splice—with thick-wall, self-sealing, heat-

shrinkable products—is the accepted system for strain relief, environmental sealing, and phase identification for power cables. Tubing accommodates a large difference between cable diameters. Sigmaform boots can replace tapes, epoxies, and dips.

Installation

Minimum shrink temperature: 121°C [250°F]

Specifications/Approvals

Series	Military	Industry
2E171-4	NAVSEA 803-5001027-17	DNV
	MIL-C-24368	Lloyd's
	MIL-DTL-23053/15* and MIL-I-81765/1	ABS

Ordering Information

Part No.	Model
2E171-4	In-line splice cable sealing kit**

- **Each kit contains:
- Cable breakout boot
 - Three-phase identification tubings (red, white, and black)
 - Three connector tubings
 - A #100 grit emery cloth
 - Installation instructions

Available in:	Americas	Europe	Asia Pacific
	■	■	■

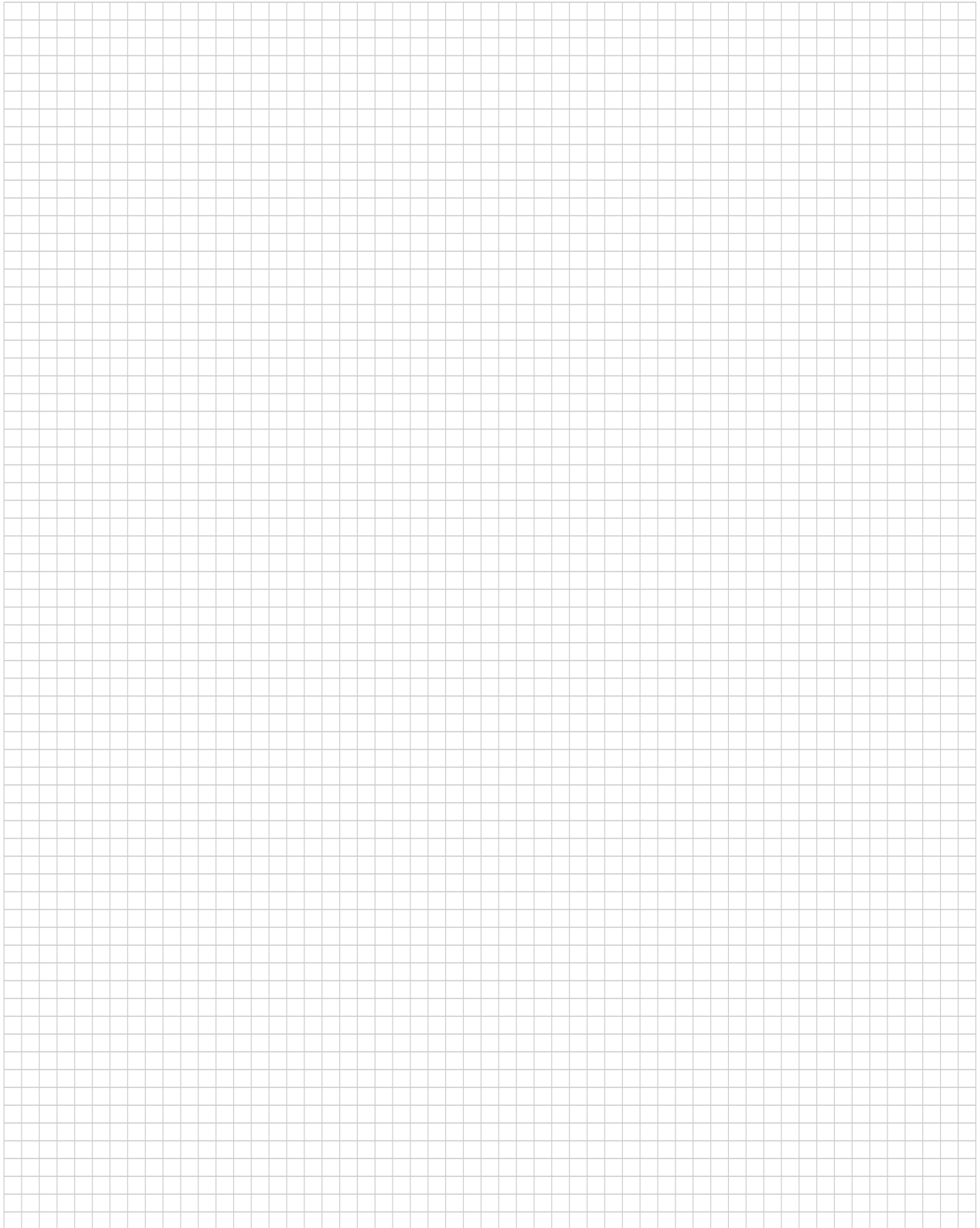

Table of Contents

Introduction 8-2

Typical SolderSleeve Device/Installation 8-2

Product Selection 8-3, 8-4

Wire-to-Wire Splicing

 Introduction 8-5

 SolderSleeve Wire Splices 8-6 to 8-11

 SolderGrip Closed End Connector Splices 8-12 to 8-17

 DuraSeal Heat-Shrinkable, Environmentally-Sealed,
 Nylon-Insulated Crimp Splices 8-18, 8-19

 PolyCrimp Heat-Shrinkable Polyethylene Crimp Splices 8-20, 8-21

 MiniSeal High-Performance, Immersion-Resistant Crimp Splices 8-22 to 8-25

Insulated Terminals and Disconnects

 Introduction 8-26

 DuraSeal Heat-Shrinkable, Environmentally-Sealed,
 Nylon-Insulated Crimp Terminals and Disconnects 8-27 to 8-32

 SolderGrip Self-Fixturing Insulated Terminals 8-33 to 8-37

Wire Termination to Pin/Post/Tab

 Introduction 8-38

 SolderSleeve Discrete Wire Terminators 8-39 to 8-42

Shield Termination

 Introduction 8-43

 SolderSleeve Shield Terminators 8-44 to 8-49

Coaxial Cable Termination

 Introduction 8-50

 SolderSleeve Coaxial Cable Terminators 8-51, 8-52

 SolderSleeve PCB/Coaxial Cable Terminators 8-53, 8-54

 RF One-Step BNC/TNC Connectors 8-55 to 8-60

Cable-to-Cable Splicing

 Introduction 8-61

 SolderShield Shielded and Coaxial Cable Splices 8-62 to 8-65

Shielded Contacts

 Introduction 8-66

 SolderTacts shielded one-piece solder contacts 8-67 to 8-75

Data Bus (MIL-STD-1553B) Components

 Introduction 8-76

 Cables 8-77, 8-78

 In-Line Microcouplers: One- and Two- Stub 8-79 to 8-81

 Ultra Lightweight In-Line Microcouplers 1- Through 6-Stub 8-82 to 8-84

 Box Couplers 8-85, 8-86

 Discrete Connectors 8-87, 8-88

 Accessories 8-89 to 8-93

 Triaxial Size 8 Contacts 8-94

 Space-Grade Data Bus Components 8-95 to 8-97

 Customer-Specified Harness Assemblies and HarnWare 8-98

 Parts List 8-98

Other

 HexaShield, High Performance EMC Adapters 8-99 to 8-104

 MTC Crimp Connectors 8-105 to 8-111

Note: Users should independently evaluate the suitability of the product for their application. Before ordering, check with Tyco Electronics for most current data.

Introduction

Tyco Electronics' dependable, economical wire and cable termination products provide solutions for hundreds of wire and cable interconnect requirements. All Raychem wire termination products are housed inside transparent heat-shrinkable insulation sleeves, which provide inspectability and can provide various levels of environmental protection. Most Raychem termination products incorporate a fluxed solder preform, which is essential for a highly controlled soldering process. Other products incorporate controlled crimping or a unique process of combining a twist-on coil with controlled soldering to provide high-reliability joints on the widest variety of conductor types and platings.

SolderSleeve technology ensures high-quality electrical and mechanical performance time after time. Premeasured solder and flux create repeatable, reliable terminations, reducing rejects and field failures. When the SolderSleeve device is heated, the tubing shrinks and the solder preform melts to make a fully insulated, strain-relieved, protected solder connection. Heat-shrinkable tubing provides the benefits of insulation, strain relief, and protection for our controlled crimp products. Many Raychem interconnect products have earned UL recognition or MIL-Spec approval.

Many SolderSleeve and related devices are made from polyvinylidene fluoride tubings that meet the requirements of AMS-DTL-23053/8 (formerly MIL-DTL-23053/8).

Raychem interconnect devices combine high-strength materials with innovative design for consistent, long-life performance. And because the insulation sleeve is transparent, operators can easily inspect the connection.

Raychem shrink-to-fit technology even helps reduce inventory, because one device size will fit a wide range of wire gauges, cable diameters, and component shapes.

Raychem interconnect products are designed for many applications, from simple splices to terminators for sophisticated electronic systems, either sealed or unsealed, and for high- or low-temperature environments.

Typical SolderSleeve Device (illustration of shield terminator concept)

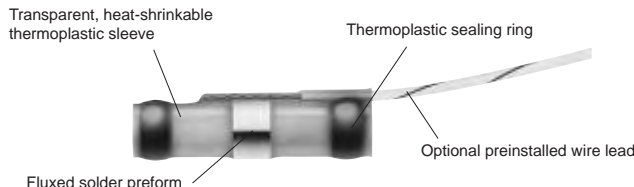

Typical Installation

1. Insert prepared cable



2. Apply heat

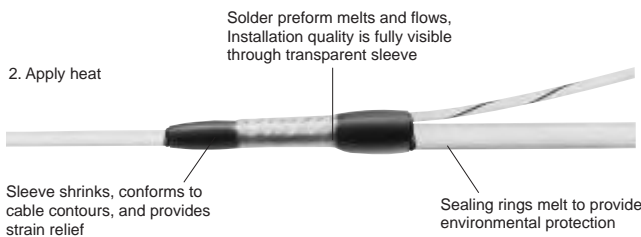



Application Type	Max. Operating Temp.	Connection Type	Product Description	Series	Page Number
Wire-to-wire splicing	125°C [257°F]	Solder	SolderSleeve wire splices	CWT-900X	8-6
	150°C [302°F]	Solder	SolderSleeve wire splices	D-110, D-1744	8-6
	125°C [257°F]	Coil and solder	SolderGrip closed end connector splices (stub)	SGRP, SGRS	8-12
	125°C [257°F]	Crimp	DuraSeal crimp splices	D-406	8-18
	125°C [257°F]	Crimp	PolyCrimp wire splices	C-203	8-20
	150°C [302°F]	Crimp	MiniSeal crimp splices	D-436 (M81824)	8-22
Terminals and disconnects	125°C [257°F]	Crimp	DuraSeal crimp terminals and disconnects	B-106	8-27
	150°C [302°F]	Coil and solder	SolderGrip terminals	SGRT	8-33
Wire termination to pin/post/tab	125°C [257°F]	Solder	SolderSleeve wire terminators	CWT-15XX	8-39
	150°C [302°F]	Solder	SolderSleeve wire terminators	D-129, D-141, D-71X	8-39
Shield termination	125°C [257°F]	Solder	SolderSleeve shield terminators	CWT-X	8-44
	150°C [302°F]	Solder	SolderSleeve shield terminators	S01, S02, M83519, SO63	8-44
	175°C [347°F]	Solder	SolderSleeve shield terminators	SO96	8-44
Coaxial cable termination	125°C [257°F]	Solder	SolderSleeve coaxial cable terminators	CWT-4XXX	8-51
	150°C [302°F]	Solder	SolderSleeve coaxial cable terminators	B-02X, B-04X	8-51
	150°C [302°F]	Solder	SolderSleeve PCB/coaxial cable terminators	D-607, B-046	8-53
	135°C [275°F]	Solder	RF one-step BNC/TNC connectors	RBD, RTD	8-55
Cable-to-cable splicing	150°C [302°F]	Solder/Crimp	SolderShield cable splices	D-150	8-62
Shielded contacts	150°C [302°F]	Solder	SolderTacts shielded contacts	D-602	8-67
Triax connectors	150°C [302°F]	Solder	Triax discrete connectors	D-621, DK-621	8-87
MIL-STD-1553	150°C [302°F]	Solder	Triax discrete connectors	D-621, DK-621	8-87
Data bus connectors	150°C [302°F]	Solder	Triax discrete connectors	D-621, DK-621	8-87
MIL-STD-1553 In-line couplers	150°C [302°F]	Solder or connectorized	In-line data bus microcoupler	D-500-04	8-79
MIL-STD-1533	150°C [302°F]	Connectorized	Data bus box couplers	D-500-025	8-85
Triaxial size 8 contacts	150°C [302°F]	Solder	Size 8, triaxial MIL-C-38999 contacts	D-602, DK-602	8-94
Data bus cables	150°C [302°F]	Crimp or solder	MIL-STD-1553 B shielded cable	1061X	8-77
Data bus terminators	150°C [302°F]	Solder or connectorized	MIL-STD-1553 78 Ohms and 3000 Ohms terminators	D-621, D-500	8-89
Data bus accessories	150°C [302°F]	Solder or mechanical	Dust caps, braid terminators, splices	D-600, D-150	8-89

Product Selection (Continued)

Application Type	Connection Type	Max. Operating Temp.	Product Description	Series	Page Number
Wire-to-Wire Splicing	Solder	125°C	SolderSleeve wire splices	CWT-900X	8-6
		150°C	SolderSleeve wire splices	D-110, D-1744	8-6
	Crimp	125°C	DuraSeal crimp splices	D-406	8-18
		125°C	PolyCrimp crimp splices	C-203	8-20
	Coil and Solder	150°C	MiniSeal crimp splices	D-436 (M81824)	8-22
		125°C	SolderGrip closed end connector splices (stub)	SGRP, SGRS	8-12
Terminals and Disconnects	Crimp	125°C	DuraSeal crimp terminals and disconnects	B-106	8-27
	Coil and Solder	150°C	SolderGrip terminals	SGRT	8-33
Wire Termination to pin/post/tab	Solder	125°C	SolderSleeve wire terminators	CWT-15XX	8-39
		150°C	SolderSleeve wire terminators	D-129, D-141, D-71X	8-39
Shield Termination	Solder	125°C	SolderSleeve shield terminators	CWT-X	8-44
		150°C	SolderSleeve shield terminators	S01, S02, M83519, S063	8-44
		175°C	SolderSleeve shield terminators	SO96	8-44
Coax Cable Termination	Solder	125°C	SolderSleeve coaxial cable terminators	CWT-4XXX	8-51
		135°C	RF one-step BNC/TNC connector	RBD, RTD	8-55
		150°C	SolderSleeve coaxial cable terminators	B-02X/04X	8-51
			SolderSleeve PCB/coaxial cable terminators	D-607, B-046	8-53
Cable-to-Cable Splicing	Solder/Crimp	150°C	SolderShield cable splices	D-150, B-202	8-62
Shielded Contacts	Solder	150°C	SolderTacts shielded contacts	D-602	8-67
MIL-STD-1553B Data Bus Components	Solder	150°C	Data bus couplers, connectors, terminators, accessories	D-500, D-600, D(K)-621	8-76

**Introduction**

Tyco Electronics offers many products for wire-to-wire splicing: Raychem SolderSleeve splicing devices; SolderGrip splices; and DuraSeal and MiniSeal crimp splices. Like all Raychem interconnect products, the wire-to-wire splicing devices are rugged and reliable, yet easy to install.

Designed for applications with temperatures up to 150°C [302°F], products in this section include:

- SolderSleeve splicing devices, which can be used to make sealed or unsealed splices. In a single step, they solder, insulate, encapsulate, and strain-relieve a wide range of wire sizes.
- DuraSeal heat-shrinkable nylon crimp splices are easy to use in factory or repair applications. DuraSeal crimp splices provide watertight sealing and superior protection against corrosion, abrasion, and vibration.
- Small, lightweight, and low-profile MiniSeal high-performance crimp splices, which substantially reduce wire bundle size and weight, are QPL-listed to the MIL-S-81824 specification, and are required by the MIL-W-5088 specification.
- SolderGrip splices, which are closed-end connectors utilizing a spiral copper coil that grips and compresses the conductors and allows a prefluxed solder ring to flow to the center of the splicing area, resulting in a high-reliability, repeatable solder joint.
- PolyCrimp heat-shrinkable polyethylene crimp splices offer a one-piece design and translucent tubing which allows for visual inspection of the splice. The dual wall polyethylene tubing provides strain relief and protection against the environment.

SolderSleeve Wire Splices

Product Facts

- Transparent polyvinylidene fluoride or polyolefin sleeve provides encapsulation, inspectability, strain relief, and insulation
- Prefluxed solder preform provides a controlled soldering process
- One-piece design makes installation easy and lowers the installed cost
- With one or two wires per end, the NAS 1744 splices meet 75,000 ft [22,000 m] altitude immersion requirement
- Thermochromic temperature indicator in the NAS splices facilitates termination and inspection
- UL and CUL recognized 

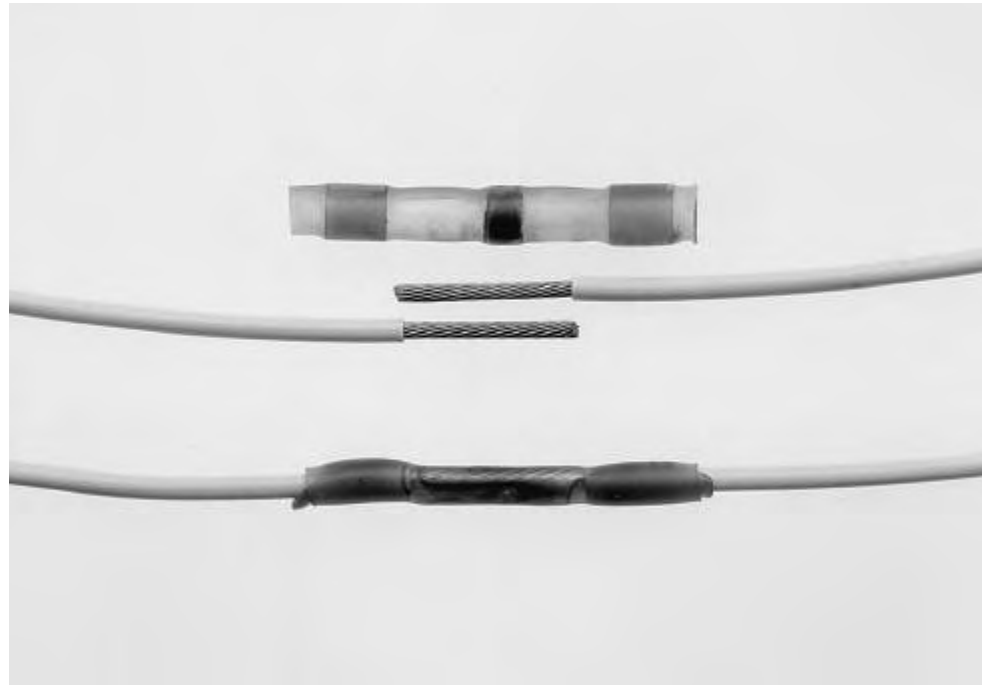

Applications

In-line wire splices.

Product Options

Product Series	Minimum Wire Temperature Rating	Maximum Operating Temperature	Intended Application Environment
CWT	85°C [185°F]	125°C [257°F]	Splashproof
D-110	125°C [257°F]	150°C [302°F]	Splashproof
D-1744 (NAS 1744)	125°C [257°F]	150°C [302°F]	Immersion sealed

Note: Cadmium-free option (B-152 series) is available for operating temperature of 125°C [257°F]. Consult Tyco Electronics for details.

Product Selection Process

From the Product Options table above, select the product series appropriate for your application based on the temperature rating and sealing performance required.

If the application has only one size of wire per side and no more than two wires on either side:

1. Determine wire gauge sizes for both sides of splice.
2. Determine number of wires (one or two wires) for each side of splice.
3. Select part numbers from the appropriate table:

- For CWT series (low temperature): Use Table A on page 8-7.

- For D-110 series (splashproof): Use Table B on page 8-8.

- For D-1744 series (immersion sealed): Use Table C on page 8-9.

If the application has more than one size of wire per side or more than two wires on either side (or if you prefer to work with CMA or mm² sizes):

1. Turn to "CMA/mm² Calculation" on page 8-10 and use the workspace there to calculate the total cross section to be spliced.
2. Use Table E on page 8-11 to select the sleeve recommended for that cross section.

Notes:

While all combinations listed will provide satisfactory solder joints, the degree of strain relief obtained depends on the outer diameter of the wires being joined. Refer to Table E for the recommended size ranges for the sleeves.

Wires 16 AWG (1.21 mm²) and larger, and wires having more than 19 strands, should be pretinned prior to splicing, to obtain the optimum solder joint quality.

Part selection for wires 26 AWG (0.15 mm²) and smaller is covered on page 8-8.

Available in:

- Americas ■
- Europe ■
- Asia Pacific ■

Table A:
CWT Series Selection

Side A:		Side B: Size and Number of Conductors							
Size and Number of Conductors		26 AWG		24 AWG		22 AWG		20 AWG	
		1	2	1	2	1	2	1	2
26 AWG	1	CWT-9001	CWT-9001	CWT-9001	CWT-9001	CWT-9001	CWT-9002	CWT-9002	CWT-9002
	2	CWT-9001	CWT-9001	CWT-9001	CWT-9002	CWT-9001	CWT-9002	CWT-9002	CWT-9002
24 AWG	1	CWT-9001	CWT-9001	CWT-9001	CWT-9001	CWT-9001	CWT-9002	CWT-9002	CWT-9002
	2	CWT-9001	CWT-9002	CWT-9001	CWT-9002	CWT-9002	CWT-9002	CWT-9002	CWT-9002
22 AWG	1	CWT-9001	CWT-9001	CWT-9001	CWT-9002	CWT-9002	CWT-9002	CWT-9002	CWT-9002
	2	CWT-9002	CWT-9002	CWT-9002	CWT-9002	CWT-9002	CWT-9002	CWT-9002	CWT-9003
20 AWG	1	CWT-9002	CWT-9002	CWT-9002	CWT-9002	CWT-9002	CWT-9002	CWT-9002	CWT-9003
	2	CWT-9002	CWT-9002	CWT-9002	CWT-9002	CWT-9002	CWT-9003	CWT-9003	CWT-9003
18 AWG	1	CWT-9002	CWT-9002	CWT-9002	CWT-9002	CWT-9002	CWT-9002	CWT-9002	CWT-9003
	2	CWT-9003	CWT-9003	CWT-9003	CWT-9003	CWT-9003	CWT-9003	CWT-9003	CWT-9003
16 AWG	1	CWT-9002	CWT-9002	CWT-9002	CWT-9002	CWT-9002	CWT-9003	CWT-9003	CWT-9003
	2	CWT-9003	CWT-9003	CWT-9003	CWT-9003	CWT-9003	CWT-9003	CWT-9003	CWT-9003
14 AWG	1	CWT-9003	CWT-9003	CWT-9003	CWT-9003	CWT-9003	CWT-9003	CWT-9003	CWT-9003
	2	CWT-9004	CWT-9004	CWT-9004	CWT-9004	CWT-9004	CWT-9004	CWT-9004	CWT-9004
12 AWG	1	CWT-9003	CWT-9003	CWT-9003	CWT-9003	CWT-9003	CWT-9003	CWT-9003	CWT-9004
	2	CWT-9005	CWT-9005	CWT-9005	CWT-9005	CWT-9005	CWT-9005	CWT-9005	CWT-9005
10 AWG	1	CWT-9005	CWT-9005	CWT-9005	CWT-9005	CWT-9005	CWT-9005	CWT-9005	CWT-9005

Side A:		Side B: Size and Number of Conductors								
Size and Number of Conductors		18 AWG		16 AWG		14 AWG		12 AWG		10 AWG
		1	2	1	2	1	2	1	2	1
26 AWG	1	CWT-9002	CWT-9003	CWT-9002	CWT-9003	CWT-9003	CWT-9004	CWT-9003	CWT-9005	CWT-9005
	2	CWT-9002	CWT-9003	CWT-9002	CWT-9003	CWT-9003	CWT-9004	CWT-9003	CWT-9005	CWT-9005
24 AWG	1	CWT-9002	CWT-9003	CWT-9002	CWT-9003	CWT-9003	CWT-9004	CWT-9003	CWT-9005	CWT-9005
	2	CWT-9002	CWT-9003	CWT-9002	CWT-9003	CWT-9003	CWT-9004	CWT-9003	CWT-9005	CWT-9005
22 AWG	1	CWT-9002	CWT-9003	CWT-9002	CWT-9003	CWT-9003	CWT-9004	CWT-9003	CWT-9005	CWT-9005
	2	CWT-9002	CWT-9003	CWT-9003	CWT-9003	CWT-9003	CWT-9004	CWT-9003	CWT-9005	CWT-9005
20 AWG	1	CWT-9002	CWT-9003	CWT-9003	CWT-9003	CWT-9003	CWT-9004	CWT-9003	CWT-9005	CWT-9005
	2	CWT-9003	CWT-9003	CWT-9003	CWT-9003	CWT-9003	CWT-9004	CWT-9004	CWT-9005	CWT-9005
18 AWG	1	CWT-9003	CWT-9003	CWT-9003	CWT-9003	CWT-9003	CWT-9004	CWT-9004	CWT-9005	CWT-9005
	2	CWT-9003	CWT-9003	CWT-9003	CWT-9004	CWT-9003	CWT-9004	CWT-9004	CWT-9005	CWT-9005
16 AWG	1	CWT-9003	CWT-9003	CWT-9003	CWT-9003	CWT-9003	CWT-9004	CWT-9004	CWT-9005	CWT-9005
	2	CWT-9003	CWT-9004	CWT-9003	CWT-9004	CWT-9004	CWT-9005	CWT-9004	CWT-9005	CWT-9005
14 AWG	1	CWT-9003	CWT-9003	CWT-9003	CWT-9004	CWT-9003	CWT-9004	CWT-9004	CWT-9005	CWT-9005
	2	CWT-9004	CWT-9004	CWT-9004	CWT-9005	CWT-9004	CWT-9005	CWT-9005	CWT-9005	CWT-9005
12 AWG	1	CWT-9004	CWT-9004	CWT-9004	CWT-9004	CWT-9004	CWT-9005	CWT-9004	CWT-9005	CWT-9005
	2	CWT-9005	CWT-9005	CWT-9005	CWT-9005	CWT-9005	CWT-9005	CWT-9005	CWT-9005	CWT-9005
10 AWG	1	CWT-9005	CWT-9005	CWT-9005	CWT-9005	CWT-9005	CWT-9005	CWT-9005	CWT-9005	CWT-9005

Table B:
D-110 Series Selection

Side A:		Side B: Size and Number of Conductors							
Size and Number of Conductors		26 AWG		24 AWG		22 AWG		20 AWG	
		1	2	1	2	1	2	1	2
26 AWG	1	D-110-35	D-110-35	D-110-35	D-110-35	D-110-35	D-110-41	D-110-41	D-110-41
	2	D-110-35	D-110-35	D-110-35	D-110-41	D-110-35	D-110-41	D-110-41	D-110-41
24 AWG	1	D-110-35	D-110-35	D-110-35	D-110-35	D-110-35	D-110-41	D-110-41	D-110-41
	2	D-110-35	D-110-41	D-110-35	D-110-41	D-110-41	D-110-41	D-110-41	D-110-41
22 AWG	1	D-110-35	D-110-35	D-110-35	D-110-41	D-110-41	D-110-41	D-110-41	D-110-41
	2	D-110-41	D-110-41	D-110-41	D-110-41	D-110-41	D-110-41	D-110-41	D-110-0181
20 AWG	1	D-110-41	D-110-41	D-110-41	D-110-41	D-110-41	D-110-41	D-110-41	D-110-0181
	2	D-110-41	D-110-41	D-110-41	D-110-41	D-110-41	D-110-0181	D-110-0181	D-110-0181
18 AWG	1	D-110-41	D-110-41	D-110-41	D-110-41	D-110-41	D-110-41	D-110-41	D-110-0181
	2	D-110-0181	D-110-0181	D-110-0181	D-110-0181	D-110-0181	D-110-0101	D-110-0101	D-110-0101
16 AWG	1	D-110-41	D-110-41	D-110-41	D-110-41	D-110-41	D-110-0181	D-110-0181	D-110-0181
	2	D-110-0101	D-110-0101	D-110-0101	D-110-0101	D-110-0181	D-110-0101	D-110-0101	D-110-0101
14 AWG	1	D-110-0181	D-110-0181	D-110-0181	D-110-0181	D-110-0181	D-110-0101	D-110-0101	D-110-0101
	2	D-110-0101	D-110-0101	D-110-0101	D-110-0101	D-110-0101	D-110-0090	D-110-0101	D-110-0090
12 AWG	1	D-110-0101	D-110-0101	D-110-0101	D-110-0101	D-110-0101	D-110-0101	D-110-0101	D-110-0101
	2	D-110-0090	D-110-0090	D-110-0090	D-110-0090	D-110-0090	D-110-0090	D-110-0090	D-110-0090
10 AWG	1	D-110-0090	D-110-0090	D-110-0090	D-110-0090	D-110-0090	D-110-0083	D-110-0083	D-110-0083

Side A:		Side B: Size and Number of Conductors								
Size and Number of Conductors		18 AWG		16 AWG		14 AWG		12 AWG		10 AWG
		1	2	1	2	1	2	1	2	1
26 AWG	1	D-110-41	D-110-0181	D-110-41	D-110-0101	D-110-0181	D-110-0101	D-110-0101	D-110-0101	D-110-0090
	2	D-110-41	D-110-0181	D-110-41	D-110-0101	D-110-0181	D-110-0101	D-110-0101	D-110-0101	D-110-0090
24 AWG	1	D-110-41	D-110-0181	D-110-41	D-110-0101	D-110-0181	D-110-0101	D-110-0101	D-110-0101	D-110-0090
	2	D-110-41	D-110-0181	D-110-41	D-110-0101	D-110-0181	D-110-0101	D-110-0101	D-110-0101	D-110-0090
22 AWG	1	D-110-41	D-110-0181	D-110-41	D-110-0181	D-110-0181	D-110-0101	D-110-0101	D-110-0101	D-110-0090
	2	D-110-41	D-110-0101	D-110-0181	D-110-0101	D-110-0101	D-110-0090	D-110-0101	D-110-0101	D-110-0090
20 AWG	1	D-110-41	D-110-0101	D-110-0181	D-110-0101	D-110-0101	D-110-0101	D-110-0101	D-110-0101	D-110-0090
	2	D-110-0181	D-110-0101	D-110-0181	D-110-0101	D-110-0101	D-110-0090	D-110-0101	D-110-0101	D-110-0090
18 AWG	1	D-110-0181	D-110-0101	D-110-0181	D-110-0101	D-110-0101	D-110-0090	D-110-0101	D-110-0101	D-110-0090
	2	D-110-0101	D-110-0101	D-110-0101	D-110-0101	D-110-0101	D-110-0090	D-110-0090	D-110-0090	D-110-0083
16 AWG	1	D-110-0181	D-110-0101	D-110-0181	D-110-0101	D-110-0101	D-110-0090	D-110-0101	D-110-0101	D-110-0090
	2	D-110-0101	D-110-0101	D-110-0101	D-110-0090	D-110-0101	D-110-0090	D-110-0090	D-110-0083	D-110-0083
14 AWG	1	D-110-0101	D-110-0101	D-110-0101	D-110-0101	D-110-0101	D-110-0090	D-110-0090	D-110-0090	D-110-0083
	2	D-110-0090	D-110-0090	D-110-0090	D-110-0090	D-110-0090	D-110-0090	D-110-0090	D-110-0083	D-110-0083
12 AWG	1	D-110-0101	D-110-0090	D-110-0101	D-110-0090	D-110-0090	D-110-0090	D-110-0090	D-110-0083	D-110-0083
	2	D-110-0090	D-110-0090	D-110-0090	D-110-0083	D-110-0090	D-110-0083	D-110-0083	D-110-0083	D-110-0083
10 AWG	1	D-110-0083	D-110-0083	D-110-0083	D-110-0083	D-110-0083	D-110-0083	D-110-0083	D-110-0083	D-110-0083

Fine Wire Splices 26 AWG (0.15 mm²) and Smaller

Part No.	Inside Diameter		
	As Supplied*	Fully Recovered**	Length***
D-110-0071	0.9 [0.035]	0.6 [0.025]	4.7 [0.185]
D-110-0213	0.9 [0.035]	0.6 [0.025]	4.2 [0.165]
D-110-0214	0.6 [0.025]	0.3 [0.013]	6.3 [0.250]
D-110-0217	1.0 [0.040]	0.6 [0.025]	9.1 [0.360]
D-110-40	0.6 [0.025]	0.5 [0.021]	5.1 [0.200]

Note: Micro SolderSleeve terminations are used for splicing wires smaller than 26 AWG [0.15 mm²].
 *Minimum. Wire insulation must be smaller than this.
 **Maximum. Wire insulation and combined conductor diameters must be greater than this.
 ***Nominal. Wire strip length must be approximately one-half of this.

Table C:
D-1744 Series Selection

Side A:		Side B: Size and Number of Conductors							
Size and Number of Conductors		26 AWG		24 AWG		22 AWG		20 AWG	
		1	2	1	2	1	2	1	2
26 AWG	1	D-1744-01	D-1744-01	D-1744-01	D-1744-01	D-1744-01	D-1744-01	D-1744-01	D-1744-02
	2	D-1744-01	D-1744-01	D-1744-01	D-1744-01	D-1744-01	D-1744-02	D-1744-01	D-1744-02
24 AWG	1	D-1744-01	D-1744-01	D-1744-01	D-1744-01	D-1744-01	D-1744-01	D-1744-01	D-1744-02
	2	D-1744-01	D-1744-01	D-1744-01	D-1744-01	D-1744-01	D-1744-02	D-1744-02	D-1744-02
22 AWG	1	D-1744-01	D-1744-01	D-1744-01	D-1744-01	D-1744-01	D-1744-02	D-1744-01	D-1744-02
	2	D-1744-01	D-1744-02	D-1744-01	D-1744-02	D-1744-02	D-1744-02	D-1744-02	D-1744-02
20 AWG	1	D-1744-01	D-1744-01	D-1744-01	D-1744-02	D-1744-01	D-1744-02	D-1744-02	D-1744-02
	2	D-1744-02	D-1744-02	D-1744-02	D-1744-02	D-1744-02	D-1744-02	D-1744-02	D-1744-03
18 AWG	1	D-1744-02	D-1744-02	D-1744-02	D-1744-02	D-1744-02	D-1744-02	D-1744-02	D-1744-03
	2	D-1744-03	D-1744-03	D-1744-03	D-1744-03	D-1744-03	D-1744-03	D-1744-03	D-1744-03
16 AWG	1	D-1744-02	D-1744-02	D-1744-02	D-1744-02	D-1744-02	D-1744-02	D-1744-02	D-1744-03
	2	D-1744-03	D-1744-03	D-1744-03	D-1744-03	D-1744-03	D-1744-03	D-1744-03	D-1744-03
14 AWG	1	D-1744-03	D-1744-03	D-1744-03	D-1744-03	D-1744-03	D-1744-03	D-1744-03	D-1744-03
	2	D-1744-03	D-1744-03	D-1744-03	D-1744-03	D-1744-03	D-1744-03	D-1744-03	D-1744-04
12 AWG	1	D-1744-03	D-1744-03	D-1744-03	D-1744-03	D-1744-03	D-1744-03	D-1744-04	D-1744-04
	2	D-1744-04	D-1744-04	D-1744-04	—	D-1744-04	—	—	—

Side A:		Side B: Size and Number of Conductors							
Size and Number of Conductors		18 AWG		16 AWG		14 AWG		12 AWG	
		1	2	1	2	1	2	1	2
26 AWG	1	D-1744-02	D-1744-03	D-1744-02	D-1744-03	D-1744-03	D-1744-03	D-1744-03	D-1744-04
	2	D-1744-02	D-1744-03	D-1744-02	D-1744-03	D-1744-03	D-1744-03	D-1744-03	D-1744-04
24 AWG	1	D-1744-02	D-1744-03	D-1744-02	D-1744-03	D-1744-03	D-1744-03	D-1744-03	D-1744-04
	2	D-1744-02	D-1744-03	D-1744-02	D-1744-03	D-1744-03	D-1744-03	D-1744-03	—
22 AWG	1	D-1744-02	D-1744-03	D-1744-02	D-1744-03	D-1744-03	D-1744-03	D-1744-03	D-1744-04
	2	D-1744-02	D-1744-03	D-1744-02	D-1744-03	D-1744-03	D-1744-03	D-1744-03	—
20 AWG	1	D-1744-02	D-1744-03	D-1744-02	D-1744-03	D-1744-03	D-1744-03	D-1744-03	D-1744-04
	2	D-1744-03	D-1744-03	D-1744-03	D-1744-03	D-1744-03	D-1744-04	D-1744-04	—
18 AWG	1	D-1744-02	D-1744-03	D-1744-03	D-1744-03	D-1744-03	D-1744-03	D-1744-03	—
	2	D-1744-03	D-1744-03	D-1744-03	D-1744-03	D-1744-03	D-1744-04	D-1744-03	—
16 AWG	1	D-1744-03	D-1744-03	D-1744-03	D-1744-03	D-1744-03	D-1744-04	D-1744-03	—
	2	D-1744-03	D-1744-03	D-1744-03	D-1744-03	D-1744-03	D-1744-04	D-1744-04	—
14 AWG	1	D-1744-03	D-1744-03	D-1744-03	D-1744-03	D-1744-03	D-1744-04	D-1744-03	—
	2	D-1744-03	D-1744-04	D-1744-04	D-1744-04	D-1744-04	—	—	—
12 AWG	1	D-1744-03	D-1744-03	D-1744-03	D-1744-04	D-1744-03	—	D-1744-04	—

CMA/mm² Calculation

SolderSleeve Wire Splices (Continued)

To calculate the total circular mil or mm² area of the conductors to be terminated in a single splice, follow these steps:

1. Choose either CMA or mm² as your unit of measure for selection purposes and continue to use it for all your selection criteria.
2. In the workspace below, list the CMA or mm² for each conductor that will go into the same splice. (To assist you, Table D on this page provides the CMA of typical conductors.)
3. Add together the values listed in the workspace below to obtain the total area.
4. From Table E on the next page, select the part number recommended for the total CMA or mm² you have calculated.
5. Refer to the examples on this page for further clarification.

Wire Number	CMA	mm ²	
1	_____	_____	
2	_____	_____	
3	_____	_____	
4	_____	_____	
5	_____	_____	
Total	_____	_____	Part Number: _____

CMA/mm² Examples

One-to-One Wire Splice

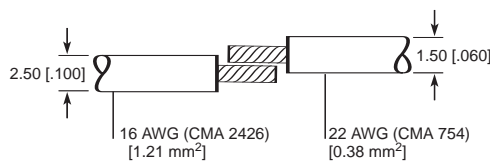

Total CMA = 3180
Total mm² = 1.59
 Correct part number selection from Table E (based on CMA/mm² and nominal jacket wire OD) = CWT-9002 or D-110-41 or D-1744-02.

Multiwire Splice

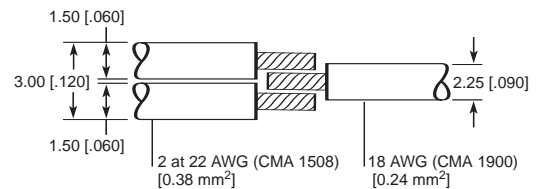

Total CMA = 3408
Total mm² = 1.71
 Correct part number selection from Table E (based on CMA/mm² and nominal jacket wire OD) = CWT-9003 or D-110-0181 or D-1744-03.

Table D.

CMA of Typical AWG Conductors

AWG	28	26	24	22	20	18	16	14	12
CMA	177	304	475	754	1216	1900	2426	3831	5874
mm ²	0.09	0.15	0.24	0.38	0.61	0.95	1.21	1.92	2.94

Installation Requirements

For proper installation of these devices the correct heating tool and reflector attachment must be used. Any one of the following Raychem heating tools is recommended:

- HL1802E
- IR-1759 MiniRay
- AA-400 Super Heater
- CV-1981

Refer to Raychem installation procedure RPIP 850-00 for D-1744 Series and RPIP 824-00 for CWT Series.

You will find ordering information for these tools in Section 10.

Table E:
Multiwire Splice Selection

Product Series	Wire Jacket OD		CMA Combined Total		mm ² Combined Total	
	Min.	Max.	Min.	Max.	Min.	Max.
CWT-9001	0.4 [0.015]	1.7 [0.066]	450	1500	0.3	1.8
CWT-9002	1.3 [0.05]	2.7 [0.106]	1250	3500	0.8	2.0
CWT-9003	1.8 [0.07]	4.5 [0.18]	2500	7200	2.0	4.0
CWT-9004	2.8 [0.11]	6.0 [0.236]	6100	19000	4.0	6.0
CWT-9005	3.2 [0.125]	7.0 [0.275]	12000	25000	6.0	10.0
D-1744-01	0.50 [0.020]	1.90 [0.075]	350	2000	-	-
D-1744-02	0.80 [0.031]	2.80 [0.110]	2000	4000	-	-
D-1744-03	1.30 [0.050]	4.57 [0.180]	4000	10000	-	-
D-1744-04	2.00 [0.080]	7.11 [0.280]	10000	13000	-	-
D-110-35	0.51 [0.020]	1.78 [0.070]	500	1500	-	-
D-110-41	1.27 [0.050]	2.54 [1.00]	1200	3500	-	-
D-110-0181	1.9 [0.075]	4.5 [0.177]	3600	6000	-	-
D-110-0101	2.41 [0.095]	4.32 [0.17]	4800	9000	-	-
D-110-0090	3.56 [0.140]	7.11 [0.28]	8500	16200	-	-
D-110-0083	4.0 [0.160]	8.76 [0.345]	16200	25000	-	-

Product Characteristics

Material	
Insulation (D-110, D-1744)	Radiation-crosslinked, heat-shrinkable polyvinylidene fluoride
Insulation (CWT)	Radiation-crosslinked, heat-shrinkable polyolefin
Solder and flux (D-110, D-1744)	Solder: Sn63 Pb37 Flux: ROL1 per ANSI-J-004 (RMA flux)
Solder and flux (CWT)	Solder: Sn50 Pb32 Cd18 Flux: ROM1 per ASNS-J-004 (RA flux)
Meltable inserts (CWT, D-1744)	Meltable thermoplastic
Typical Performance	
Voltage drop	2.0 mV
Tensile strength	Exceeds strength of conductor
Dielectric strength	2.0 kV
Temperature rating (CWT)	-55°C to +125°C [-67°F to +257°F]
Temperature rating (D-110, D-1744)	-55°C to +150°C [-67°F to +302°F]
Insulation resistance	1000 megohms

Specifications/Approvals

Series	Agency	Raychem
CWT	UL E87681	D-5023
D-110	UL E87681	RT-1404
D-1744	NAS-1744	RT-1404

Product Facts

- Soldered connection
- Electrical insulation
- Sealed for immersion (SGRS)
- Excellent strain relief
- Simple installation

SolderGrip Closed End Connector Splices

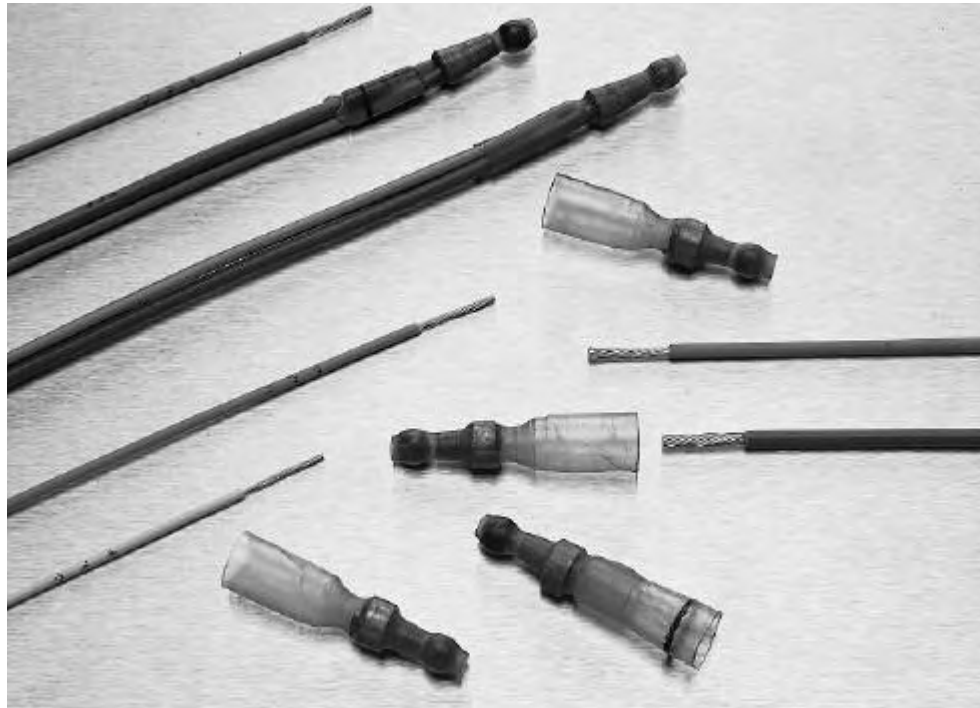

Applications

SolderGrip heat-shrinkable solder-type closed-end connectors are designed for electrical termination of multiple-wire combinations. They provide a reliable alternative to crimping, welding, or conventional twist-on-style closed-end connectors.

Their unique combination of wire fixturing and controlled-soldering technology provides dependable electrical termination of multiple wire combinations.

SolderGrip terminators consist of a heat-shrinkable thermoplastic sleeve containing a spiral-wound copper insert. The insert is fitted with a prefluxed solder band.

This innovation design allows SolderGrip products to reliably terminate as many as 10 wires of different sizes and types in a single device.

The capability of SolderGrip terminators encompasses single or multistranded, bare or tinned copper wires with low- or high-temperature insulation.

The termination is environmentally protected and strain relieved.

SolderGrip splice terminators are color-coded for easy identification.

Product Options

Product Series	Environmental Protection	Max. Operating Temp.
SGRP	Splashproof	125°C [257°F]
SGRS	Sealed	125°C [257°F]

Available in:

- Americas ■
- Europe ■
- Asia Pacific ■

SolderGrip Closed End Connector Splices (Continued)

Product Selection Process

1. From the Product Options table on the previous page, select the product series appropriate for your application.
2. Determine the wire combination (number of wires and size) of the wire bundle you wish to splice.
3. Use Table C (page 8-15) to select the correct connector for AWG wire combinations.* For mm² wire combinations use Table A to select a SolderGrip part number.

Example: For connecting a bundle with one 12 AWG wire (1 #12) and two 14 AWG wires (+2 #14), you need an SGRP-3 connector. For sealed parts, select the SGRS series.

*If the wire combination is not listed in Table C, use the CMA (mm²) method of determining wire bundle size (see "CMA/mm² Calculation" on page 8-14). Using Table B (page 8-14, select the smallest size connector that will fit your total wire CMA (mm²) value.

4. Verify that the wire bundle (with wire insulation) does not exceed the maximum diameter allowed for the connector you selected. Simply check the bundle's diameter against the maximum diameter that Table A (below) lists for that part.
5. Verify that the total amperage to be applied does not exceed the maximum amp rating for the part.

Insulated Closed-End Connectors (SGRP series)

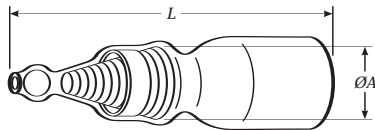

Insulated and Sealed Closed-End Connectors (SGRS series)

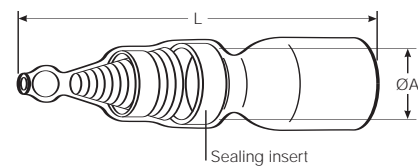

Table A - Product Dimensions and Part Number Descriptions

Part No.	Color Code	Product Dimensions (Min.)			Part No.	Color Code	Product Dimensions (Min.)		
		L	ØA	Wire Range (Min.-Max.) CMA/mm ²			L	ØA	Wire Range (Min.-Max.) CMA/mm ²
SGRP-1	Green	1.370 [34.8]	.120 [2.9]	1400 - 4800 [0.7 - 2.4]	SGRS-1	Green	1.370 [34.8]	0.130 [3.4]	1400 - 4800 [0.7 - 2.4]
SGRP-2	Red	1.350 [34.2]	.150 [3.7]	4000 - 8000 [2.0 - 4.0]	SGRS-2	Red	1.350 [34.2]	0.190 [4.8]	4000 - 8000 [2.0 - 4.0]
SGRP-3	Blue	1.610 [41.0]	.200 [5.1]	7000 - 18000 [3.5 - 8.0]	SGRS-3	Blue	1.650 [42.0]	0.290 [7.3]	7000 - 16000 [3.5 - 8.0]
SGRP-4	Yellow	1.650 [42.0]	.270 [6.8]	15000 - 30000 [7.5 - 12.0]	SGRS-4	Yellow	1.630 [41.5]	0.360 [9.1]	15000 - 24000 [7.5 - 12.0]



CMA/mm² Calculation

SolderGrip Closed End Connector Splices (Continued)

To calculate the total circular mil or mm² area of the wire bundle to be terminated, follow these steps:

1. Choose either CMA or mm² as your unit of measure for selection purposes and continue to use it for all your selection criteria. (Both measures provide the same results.)
2. In the workspace below, list the CMA or mm² for each conductor in the bundle. (Table B provides the CMA of typical conductors.)
3. Add together the values listed in the workspace below to obtain the total area.
4. Use Table A to select the smallest terminator that will fit the total CMA (mm²).

Wire Number	CMA	mm ²	
1	_____	_____	
2	_____	_____	
3	_____	_____	
4	_____	_____	
5	_____	_____	
6	_____	_____	
7	_____	_____	
8	_____	_____	
9	_____	_____	
10	_____	_____	Solder Grip Part No.
Total	_____	_____	_____

CMA/mm² Example

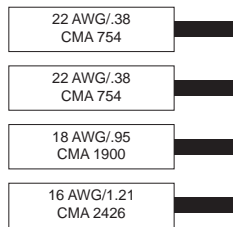

Total CMA = 5834
 Total mm² = 2.92
 Correct part number (based on CMA of 5834 or mm² of 2.92): SGRP-2or SGRS-2

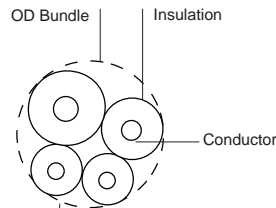

Bundle diameter must not exceed 6.0 mm (0.24 in) for SGRP-2 or 0.18 mm (4.5 in) for SGRS-2.

Table B. CMA of Typical Copper Conductors

AWG	30	28	26	24	22	20	18	16	14	12	10	8
CMA	112	177	304	475	754	1216	1900	2426	3831	5874	9354	16983
mm ²	0.05	0.09	0.15	0.24	0.38	0.61	0.95	1.21	1.92	2.94	4.74	8.61

Table C. SolderGrip Wire Combinations

Wire Combinations	Splash-proof	Sealed	Wire Combinations	Splash-proof	Sealed	Wire Combinations	Splash-proof	Sealed
1 # 8 + 1 # 12	SGRP-4	SGRS-4	1 # 14 + 3 # 20	SGRP-2	SGRS-2	2 # 16 + 1 # 18 + 3 # 20	SGRP-3	SGRS-3
1 # 8 + 1 # 16	SGRP-4	SGRS-4	1 # 14 + 4 # 20	SGRP-3	SGRS-3	2 # 16 + 1 # 18 + 2 # 20	SGRP-3	SGRS-3
2 # 8 + 2 # 16	SGRP-4	SGRS-4	1 # 14 + 1 # 18	SGRP-2	SGRS-2	2 # 16 + 1 # 18 + 1 # 20	SGRP-2	SGRS-2
1 # 8 + 1 # 14	SGRP-4	SGRS-4	1 # 14 + 1 # 18 + 1 # 20	SGRP-2	SGRS-2	2 # 16 + 1 # 18	SGRP-2	SGRS-2
1 # 8 + 1 # 14 + 1 # 16	SGRP-4	SGRS-4	1 # 14 + 2 # 18	SGRP-2	SGRS-2	2 # 16 + 4 # 20	SGRP-3	SGRS-3
1 # 10 + 1 # 18	SGRP-3	SGRS-3	1 # 14 + 3 # 18	SGRP-3	SGRS-3	2 # 16 + 3 # 20	SGRP-3	SGRS-3
1 # 10 + 2 # 18	SGRP-3	SGRS-3	1 # 14 + 4 # 18	SGRP-3	SGRS-3	2 # 16 + 2 # 20	SGRP-2	SGRS-2
1 # 10 + 3 # 18	SGRP-3	SGRS-3	1 # 14 + 5 # 18	SGRP-3	SGRS-3	2 # 16 + 1 # 20	SGRP-2	SGRS-2
1 # 10 + 1 # 16	SGRP-3	SGRS-3	1 # 14 + 1 # 16	SGRP-2	SGRS-3	2 # 16	SGRP-2	SGRS-2
1 # 10 + 1 # 16 + 1 # 18	SGRP-3	SGRS-3	1 # 14 + 1 # 16 + 1 # 20	SGRP-2	SGRS-2	1 # 16 + 5 # 18	SGRP-3	SGRS-3
1 # 10 + 1 # 16 + 2 # 18	SGRP-3	SGRS-3	1 # 14 + 1 # 16 + 1 # 18	SGRP-3	SGRS-3	1 # 16 + 4 # 18 + 1 # 20	SGRP-3	SGRS-3
1 # 10 + 2 # 16	SGRP-3	SGRS-3	1 # 14 + 1 # 16 + 2 # 18	SGRP-3	SGRS-3	1 # 16 + 4 # 18	SGRP-3	SGRS-3
1 # 10 + 3 # 16	SGRP-4	SGRS-4	1 # 14 + 1 # 16 + 3 # 18	SGRP-3	SGRS-3	1 # 16 + 3 # 18 + 2 # 20	SGRP-3	SGRS-3
1 # 10 + 4 # 16	SGRP-4	SGRS-4	1 # 14 + 1 # 16 + 4 # 18	SGRP-3	SGRS-3	1 # 16 + 3 # 18 + 1 # 20	SGRP-3	SGRS-3
1 # 10 + 5 # 16	SGRP-4	SGRS-4	1 # 14 + 2 # 16	SGRP-3	SGRS-3	1 # 16 + 2 # 18 + 3 # 20	SGRP-3	SGRS-3
1 # 10 + 1 # 14	SGRP-3	SGRS-3	1 # 14 + 2 # 16 + 1 # 18	SGRP-3	SGRS-3	1 # 16 + 2 # 18 + 1 # 20	SGRP-2	SGRS-2
1 # 10 + 1 # 14 + 1 # 18	SGRP-3	SGRS-3	1 # 14 + 2 # 16 + 2 # 18	SGRP-3	SGRS-3	1 # 16 + 2 # 18	SGRP-2	SGRS-2
1 # 10 + 1 # 14 + 1 # 16	SGRP-3	SGRS-3	1 # 14 + 2 # 16 + 3 # 18	SGRP-3	SGRS-3	1 # 16 + 1 # 18 + 4 # 20	SGRP-3	SGRS-3
1 # 10 + 1 # 14 + 2 # 16	SGRP-3	SGRS-3	1 # 14 + 3 # 16	SGRP-3	SGRS-3	1 # 16 + 1 # 18 + 3 # 20	SGRP-2	SGRS-2
1 # 10 + 1 # 14 + 3 # 16	SGRP-4	SGRS-4	1 # 14 + 3 # 16 + 1 # 18	SGRP-3	SGRS-3	1 # 16 + 1 # 18 + 2 # 20	SGRP-2	SGRS-2
1 # 10 + 2 # 14	SGRP-4	SGRS-4	1 # 14 + 3 # 16 + 2 # 18	SGRP-3	SGRS-3	1 # 16 + 1 # 18 + 1 # 20	SGRP-2	SGRS-2
1 # 10 + 3 # 14	SGRP-4	SGRS-4	1 # 14 + 4 # 16	SGRP-3	SGRS-3	1 # 16 + 1 # 18	SGRP-1	SGRS-1
1 # 10 + 1 # 12	SGRP-3	SGRS-3	1 # 14 + 4 # 16 + 1 # 18	SGRP-3	SGRS-3	1 # 16 + 4 # 20	SGRP-2	SGRS-2
1 # 10 + 1 # 12 + 1 # 14	SGRP-4	SGRS-4	1 # 14 + 5 # 16	SGRP-3	SGRS-3	1 # 16 + 3 # 20	SGRP-2	SGRS-2
1 # 10 + 2 # 12	SGRP-4	SGRS-4	2 # 14	SGRP-2	SGRS-2	1 # 16 + 1 # 20 + 1 # 22	SGRP-1	SGRS-1
2 # 10	SGRP-4	SGRS-4	2 # 14 + 1 # 16	SGRP-3	SGRS-3	1 # 16 + 1 # 20	SGRP-1	SGRS-1
2 # 10 + 1 # 16	SGRP-4	SGRS-4	2 # 14 + 1 # 16	SGRP-3	SGRS-3	1 # 16 + 3 # 22	SGRP-1	SGRS-1
1 # 12 + 1 # 18	SGRP-2	SGRS-2	2 # 14 + 1 # 16	SGRP-3	SGRS-3	1 # 16 + 2 # 22	SGRP-1	SGRS-1
1 # 12 + 2 # 18	SGRP-3	SGRS-3	2 # 14 + 1 # 16	SGRP-3	SGRS-3	1 # 16 + 1 # 22	SGRP-1	SGRS-1
1 # 12 + 3 # 18	SGRP-3	SGRS-3	2 # 14 + 2 # 16	SGRP-3	SGRS-3	1 # 18 + 1 # 22	SGRP-1	SGRS-1
1 # 12 + 4 # 18	SGRP-3	SGRS-3	2 # 14 + 2 # 16	SGRP-3	SGRS-3	1 # 18 + 2 # 22	SGRP-1	SGRS-1
1 # 12 + 5 # 18	SGRP-3	SGRS-3	2 # 14 + 3 # 16	SGRP-3	SGRS-3	1 # 18 + 3 # 22	SGRP-1	SGRS-1
1 # 12 + 1 # 16	SGRP-3	SGRS-3	2 # 14 + 4 # 16	SGRP-4	SGRS-4	1 # 18 + 1 # 20	SGRP-1	SGRS-1
1 # 12 + 1 # 16 + 1 # 18	SGRP-3	SGRS-3	3 # 14	SGRP-3	SGRS-3	1 # 18 + 1 # 20 + 1 # 22	SGRP-1	SGRS-1
1 # 12 + 1 # 16 + 2 # 18	SGRP-3	SGRS-3	3 # 14 + 1 # 16	SGRP-3	SGRS-3	1 # 18 + 1 # 20 + 2 # 22	SGRP-1	SGRS-1
1 # 12 + 1 # 16 + 3 # 18	SGRP-3	SGRS-3	3 # 14 + 2 # 16	SGRP-4	SGRS-4	1 # 18 + 2 # 20	SGRP-1	SGRS-1
1 # 12 + 1 # 16 + 4 # 18	SGRP-4	SGRS-4	3 # 14 + 3 # 16	SGRP-4	SGRS-4	1 # 18 + 3 # 20	SGRP-2	SGRS-2
1 # 12 + 2 # 16	SGRP-3	SGRS-3	4 # 14	SGRP-3	SGRS-3	1 # 18 + 4 # 20	SGRP-2	SGRS-2

SolderGrip Closed End Connector Splices (Continued)

Table C. SolderGrip Wire Combinations (Continued)

Wire Combinations	Splash-proof	Sealed	Wire Combinations	Splash-proof	Sealed	Wire Combinations	Splash-proof	Sealed
1 # 12 + 2 # 16 + 1 # 18	SGRP-3	SGRS-3	4 # 14 + 1 # 16	SGRP-4	SGRS-4	1 # 18 + 5 # 20	SGRP-2	SGRS-2
1 # 12 + 2 # 16 + 2 # 18	SGRP-3	SGRS-3	4 # 14 + 2 # 16	SGRP-4	SGRS-4	2 # 18	SGRP-1	SGRS-1
1 # 12 + 3 # 16	SGRP-3	SGRS-3	5 # 14	SGRP-4	SGRS-4	2 # 18 + 1 # 22	SGRP-1	SGRS-1
1 # 12 + 4 # 16	SGRP-3	SGRS-3	5 # 14 + 1 # 16	SGRP-4	SGRS-4	2 # 18 + 1 # 20	SGRP-2	SGRS-2
1 # 12 + 5 # 16	SGRP-4	SGRS-4	1 # 16 + 3 # 18	SGRP-3	SGRS-3	2 # 18 + 2 # 20	SGRP-2	SGRS-2
1 # 12 + 1 # 14 + 1 # 18	SGRP-3	SGRS-3	1 # 16 + 2 # 18 + 2 # 20	SGRP-3	SGRS-3	2 # 18 + 3 # 20	SGRP-2	SGRS-2
1 # 12 + 1 # 14 + 2 # 18	SGRP-3	SGRS-3	1 # 16 + 5 # 20	SGRP-3	SGRS-3	2 # 18 + 4 # 20	SGRP-3	SGRS-3
1 # 12 + 1 # 14 + 3 # 18	SGRP-3	SGRS-3	1 # 16 + 2 # 20	SGRP-2	SGRS-2	3 # 18	SGRP-2	SGRS-2
1 # 12 + 1 # 14 + 1 # 16	SGRP-3	SGRS-3	6 # 16	SGRP-3	SGRS-3	3 # 18 + 1 # 20	SGRP-2	SGRS-2
1 # 12 + 1 # 14 + 2 # 16	SGRP-3	SGRS-3	5 # 16 + 1 # 18	SGRP-3	SGRS-3	3 # 18 + 2 # 20	SGRP-3	SGRS-3
1 # 12 + 1 # 14 + 3 # 16	SGRP-4	SGRS-4	5 # 16 + 1 # 20	SGRP-3	SGRS-3	3 # 18 + 3 # 20	SGRP-3	SGRS-3
1 # 12 + 1 # 14 + 4 # 16	SGRP-4	SGRS-4	5 # 16	SGRP-3	SGRS-3	4 # 18	SGRP-2	SGRS-2
1 # 12 + 2 # 14	SGRP-3	SGRS-3	4 # 16 + 2 # 18	SGRP-3	SGRS-3	4 # 18 + 1 # 20	SGRP-3	SGRS-3
1 # 12 + 2 # 14 + 1 # 18	SGRP-3	SGRS-3	4 # 16 + 1 # 18 + 1 # 20	SGRP-3	SGRS-3	4 # 18 + 2 # 20	SGRP-3	SGRS-3
1 # 12 + 2 # 14 + 1 # 16	SGRP-4	SGRS-4	4 # 16 + 1 # 18	SGRP-3	SGRS-3	5 # 18	SGRP-3	SGRS-3
1 # 12 + 2 # 14 + 2 # 16	SGRP-4	SGRS-4	4 # 16 + 2 # 20	SGRP-3	SGRS-3	5 # 18 + 1 # 20	SGRP-3	SGRS-3
1 # 12 + 2 # 14 + 3 # 16	SGRP-4	SGRS-4	4 # 16 + 1 # 20	SGRP-3	SGRS-3	6 # 18	SGRP-3	SGRS-3
1 # 12 + 3 # 14	SGRP-4	SGRS-4	4 # 16	SGRP-3	SGRS-3	1 # 20 + 1 # 22	SGRP-1	SGRS-1
1 # 12 + 3 # 14 + 1 # 16	SGRP-4	SGRS-4	3 # 16 + 3 # 18	SGRP-3	SGRS-3	1 # 20 + 2 # 22	SGRP-1	SGRS-1
1 # 12 + 4 # 14	SGRP-4	SGRS-4	3 # 16 + 2 # 18 + 1 # 20	SGRP-3	SGRS-3	1 # 20 + 3 # 22	SGRP-1	SGRS-1
2 # 12	SGRP-4	SGRS-4	3 # 16 + 2 # 18	SGRP-3	SGRS-3	1 # 20 + 4 # 22	SGRP-1	SGRS-1
2 # 12 + 1 # 18	SGRP-3	SGRS-3	3 # 16 + 1 # 18 + 2 # 20	SGRP-3	SGRS-3	2 # 20	SGRP-1	SGRS-1
2 # 12 + 1 # 18	SGRP-3	SGRS-3	3 # 16 + 1 # 18 + 1 # 20	SGRP-3	SGRS-3	2 # 20 + 1 # 22	SGRP-1	SGRS-1
2 # 12 + 1 # 16	SGRP-3	SGRS-3	3 # 16 + 1 # 18	SGRP-3	SGRS-3	2 # 20 + 2 # 22	SGRP-1	SGRS-1
2 # 12 + 2 # 16 + 1 # 18	SGRP-4	SGRS-4	3 # 16 + 3 # 20	SGRP-3	SGRS-3	2 # 20 + 3 # 22	SGRP-1	SGRS-1
2 # 12 + 3 # 16	SGRP-4	SGRS-4	3 # 16 + 2 # 20	SGRP-3	SGRS-3	3 # 20	SGRP-1	SGRS-1
2 # 12 + 1 # 14 + 1 # 18	SGRP-4	SGRS-4	3 # 16 + 1 # 20	SGRP-3	SGRS-3	3 # 20 + 1 # 22	SGRP-1	SGRS-1
2 # 12 + 1 # 14 + 1 # 16	SGRP-4	SGRS-4	3 # 16	SGRP-2	SGRS-2	4 # 20	SGRP-2	SGRS-2
3 # 12 + 1 # 14	SGRP-4	SGRS-4	2 # 16 + 4 # 18	SGRP-3	SGRS-3	5 # 20	SGRP-2	SGRS-2
2 # 12 + 2 # 14	SGRP-4	SGRS-4	2 # 16 + 3 # 18 + 1 # 20	SGRP-3	SGRS-3	6 # 20	SGRP-2	SGRS-2
3 # 12 + 1 # 18	SGRP-4	SGRS-4	2 # 16 + 3 # 18	SGRP-3	SGRS-3	3 # 22	SGRP-1	SGRS-1
3 # 12 + 1 # 16	SGRP-4	SGRS-4	2 # 16 + 2 # 18 + 2 # 20	SGRP-3	SGRS-3	4 # 22	SGRP-1	SGRS-1
1 # 14 + 1 # 22	SGRP-1	SGRS-1	2 # 16 + 2 # 18 + 1 # 20	SGRP-3	SGRS-3	5 # 22	SGRP-1	SGRS-1
1 # 14 + 1 # 20	SGRP-2	SGRS-2	2 # 16 + 2 # 18	SGRP-3	SGRS-3	6 # 22	SGRP-1	SGRS-1
1 # 14 + 2 # 20	SGRP-2	SGRS-2	—	—	—	—	—	—

Product Characteristics

Material			
Insulation	Radiation-crosslinked, transparent heat-shrinkable polyvinylidene fluoride		
Solder preform with flux	Sn 60, Pb 40, ROM1 flux per ANSI-J-STD-004 (RA flux).		
Sealing insert (SGRS)	Hot melt adhesive		
Spiral wound insert	Copper alloy		
Physical	Unit	Method of test	Requirement
Dimensions	inches	RB-109	See product dimensions.
Electromechanical	Unit	Method of test	Typical values
Dielectric withstand voltage	kilovolts	RB-109	2.0
Static heating	degrees	RB-109	Less than 50°C rise
Environmental*	Unit	Method of test	Requirement
Insulation resistance after water immersion (SGRS only)	megohms	RB-109	100
Contact resistance after testing	milliohms	RB-109	Less than 6 milliohms
Operating condition	Unit	Method of test	Value
Temperature rating	—	—	-55°C to 125°C [-67°F to 257°F]
Voltage rating	volts	—	600

*Immersion resistance sealing is dependent on the wire combinations used. The user should test specific wire combinations. Refer to RB-109 Raychem specification for procedures.

Approvals and Reference Documents

Agency Approvals	UL, CUL E87681
Reference documents	Raychem Specification RB-109 for splices Specification Control Drawings Splices—Non Sealed (SGRP-X), Splices—Sealed (SGRS-X)

Installation

The SolderGrip product is pushed onto the conductors with a twisting motion. With the product in place, installation can be completed with the proper selection and use of heating tools and reflectors. Either of the following Raychem heating tools is recommended:

- HL1802E
- CV-1981

Refer to Raychem installation procedure RPIP 820-00 for detailed instructions and recommended reflector attachments.

You will find ordering information for these tools in Section 10.



DuraSeal Heat-Shrinkable, Environmentally Sealed, Nylon-Insulated Crimp Splices

Product Facts

- Protects splices from water, condensation, salt, and corrosion
- Provides strain relief
- Protects against vibration in rugged environments
- Completely insulates and protects electrical connections
- Has adhesive lining for protection that is more reliable than conventional splices
- UL, CUL, and Lloyd's listed 



Applications

- Automotive/truck wiring repair and maintenance.
- Automotive accessory installations.
- OEM automotive/truck/RV wire harness fabrication.
- Marine electronics.
- Fleet maintenance.
- Commercial wiring (pumps/pools/spas).
- Appliances.

Specifications/Approvals

Series	Agency	Raychem
D-406	UL and CUL listed 91J4, File E87681	RB-107
—	Lloyd's listed, File 65 247 HH 02-93	—

Product Dimensions

Butt Splices

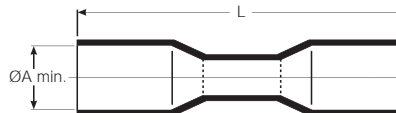

Available in:

- Americas ■
- Europe ■
- Asia Pacific ■

Part No.	Butt Splice Dimensions		Color	Conductor	Wire Dimensions	
	A Min.	L Nom.			Insulation O.D. (Max.)	Insulation O.D. (Min.)
D-406-0001	3.68 [.145]	31.75 [1.25]	Red	22-18	3.56 [.140]	1.40 [.055]
D-406-0002	4.57 [.180]	31.75 [1.25]	Blue	16-14	4.45 [.175]	2.03 [.080]
D-406-0003	6.35 [.250]	38.10 [1.50]	Yellow	12-10	6.22 [.245]	2.79 [.110]

Product Selection Process

1. Determine wire size.
2. Select part number.

Product Characteristics (Typical)

DuraSeal Heat-Shrinkable, Environmentally Sealed, Nylon-Insulated Crimp Splices (Continued)

Wire Size AWG	mm ²	Part No.	Color
22-18	0.38-0.95	D-406-0001	Red
16-14	1.2-2.5	D-406-0002	Blue
12-10	3-6	D-406-0003	Yellow

Operating temperature	-55°C to 125°C [-67°F to 257°F]
Shrink ratio	Approximately 2:1
Physical properties	Cut-through resistance: 31 kg [70 lb] Wire pullout after crimping and recovery: red: 11.3 kg [25 lb]; blue: 22.7 kg [50 lb]; yellow: 27.2 kg [60 lb] Not flame-retardant No cracking after heat aging for 168 h at 160°C [320°F]
Chemical properties	Solvent resistance: isopropyl alcohol, trichloroethylene, gasoline, battery acid, diesel fuel, motor oil, antifreeze, brake fluid, 5% salt water
Electrical properties	Dielectric strength: 2500 Vac Insulation resistance: 1000 megohms at 100 Vdc

Installation Requirements

For proper installation of these devices, the correct crimp tool and a heating tool with a reflector attachment must be used. The Raychem AD-1522 crimp tool and HL1802E heating tool are recommended.

You will find ordering information for these tools in Section 10.

Refer to Raychem installation procedure RPIP 821-00 for detailed instructions.

Installation

1. Select splice of appropriate size. Strip wire 7.5 mm (5/16 in). Insert into crimp barrel.

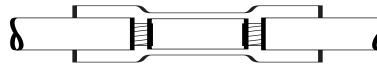

2. Crimp using Raychem AD-1522 crimp tool for preinsulated crimps.



3. Heat crimped splice with heat gun until tubing recovers and adhesive flows.



PolyCrimp Heat-Shrinkable Polyethylene Crimp Splices

Product Facts

- One-piece product reduces inventory management
- Translucent tubing allows visual inspection
- Color coded for easy selection of correct AWG
- Dual wall polyethylene tubing provides strain relief and protection against environment



Applications

- Alarms.
- Marine electronics.
- Mass transit signal wire.
- Telecom aerial splices.
- Traffic light junction boxes.
- Commercial wiring (pumps).
- Heavy industrial environments.

Specifications/Approvals

Series	Raychem
C203	D5203

Product Dimensions
Butt Splices

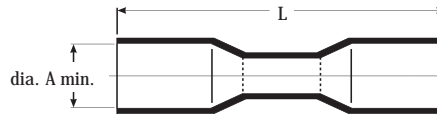

Available in:	
Americas	■
Europe	■
Asia Pacific	■

Part No.	Butt Splice Dimensions		Color	Conductor	Wire Dimensions	
	A Min.	L Nom.			Insulation O.D. (Max.)	Insulation O.D. (Min.)
C-203-01	3.68 [.145]	31.75 [1.25]	Red	22-18	3.56 [.140]	1.40 [.055]
C-203-02	4.57 [.180]	31.75 [1.25]	Blue	16-14	4.45 [.175]	2.03 [.080]
C-203-03	6.35 [.250]	38.10 [1.50]	Yellow	12-10	6.22 [.245]	—

PolyCrimp Heat-Shrinkable Polyethylene Crimp Splices (Continued)

Product Selection Process

1. Determine wire size.
2. Select part number.

Wire Size AWG	mm ²	Part No.	Color
22-18	0.38-0.95	C-203-01	Red
16-14	1.2-2.5	C-203-02	Blue
12-10	3-6	C-203-03	Yellow

Product Characteristics
(Typical)

Operating temperature	-55°C to 125°C [-67°F to 257°F]
Shrink ratio	Approximately 2:1
Physical properties	Wire pullout after crimping and recovery: red: 6.8 kg [15 lb]; blue: 18.14 kg [40 lb]; yellow: 22.7 kg [50 lb]
Chemical properties	Meets electrical test after conditioning in diesel fuel, brake fluid, ASTM fuel C and engine degreaser.
Electrical properties	Dielectric strength: 2500 Vac Insulation resistance: 1000 megohms at 100 Vdc Voltage rating: 600 Volts max.



MiniSeal High-Performance, Immersion-Resistant Crimp Splices

Product Facts

- Immersion-resistant crimp splices are on QPL for MIL-S-81824
- MIL-Spec approval
- Small size
- Light weight
- Insulation and strain relief
- Easy installation

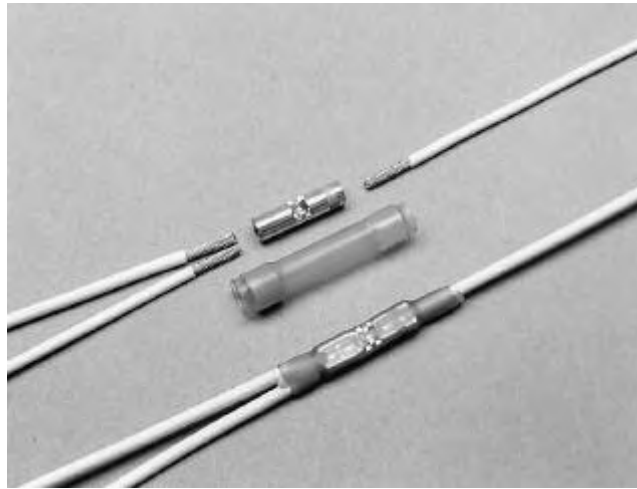

Applications

MiniSeal wire-to-wire splicing products offer solutions for hundreds of aerospace and defense applications. These environment-resistant splices provide excellent reliability, long term performance, MIL-S-81824/1 qualification, and a low installed cost.

MiniSeal crimp splices consist of a plated copper crimp barrel and a separate, heat-shrinkable, transparent sealing sleeve. They can be used on a combination of wires, from 1:1 to 10:10. MiniSeal splices are one of the smallest, lightest, and most environment-resistant splices available. They preserve the electrical integrity of the splice by preventing the penetration of liquids and the resulting chemical and galvanic corrosion.



Available in:

- Americas ■
- Europe ■
- Asia Pacific ■

Catalog 1654025
Revised 12-04

www.tycoelectronics.com

Dimensions are in millimeters and inches unless otherwise specified. Values in brackets are U.S. equivalents.

Dimensions are shown for reference purposes only. Specifications subject to change.

USA: 1-800-522-6752
Canada: 1-905-470-4425
Mexico: 01-800-733-8926
C. America: 52-55-5-729-0425

South America: 55-11-3611-1514
Japan: 81-44-900-5102
Singapore: 65-4866-151
UK: 44-1793-528171

Product Selection Process

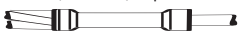
1. Determine the type of splice required.
 - Stub (parallel) splice: 
 - Butt (in-line) splice: 
2. Determine which crimp barrel plating is required:
 - Tin plating, recommended for tin or silverplated wire
 - Nickel plating, recommended for nickel-plated wire, or silver-plated wire in applications above 150°C [302°F].
3. Calculate the size of crimp barrel required.

Using the CMA/mm² worksheet on the next page, calculate the total cross section to be spliced by adding the circular mil area (CMA) or square millimeters (mm²) of each wire.

Stub splice: Add the CMA or mm² of all wires together.

Butt splice: Calculate each side separately (see example on the worksheet).

4. Select the color code for the size crimp barrel required. Using Table B (page 8-23), select the crimp barrel—color-coded red, blue, or yellow—for the CMA or mm² you calculated.
5. Determine the type of sealing sleeve required. Some wire insulations will not fit in the holes of the sealing sleeve inserts, so be sure to compare the internal diameter of each hole with the outer diameter of the wire(s) you intend to insert in that hole. To create a reliable seal, place a maximum of two wires in any hole of the sealing sleeve.
6. Select the part number. Turn to the MiniSeal part number selection tables (Tables C and D, page 8-23 and 8-24) and find the table for the type of splice (stub or butt) required.

Stub splice: Select the barrel that will accommodate the total cross section.

Butt splice: Select the smallest barrel that will accommodate the largest CMA/mm² required. (Refer to the example in the worksheet for a more specific description.) If the CMA/mm² of the smaller side of a butt splice is too small for the size barrel required to fit the larger side, increase the CMA/mm²—either by doubling back one wire (stripping the conductor twice the length you would ordinarily strip it and then folding it back) or by adding a filler wire.

Table A. CMA of Typical Conductors

MiniSeal High-Performance, Immersion-Resistant Crimp Splices (Continued)

Strands	7	19	19	19	19	19	19	19	37
AWG	28	26	24	22	20	18	16	14	12
CMA	177	304	475	754	1216	1900	2426	3831	5874
mm ²	0.09	0.15	0.24	0.38	0.61	0.95	1.21	1.92	2.94

Table B. Crimp Barrel Color Code Selection

CMA Range	mm ² Range	1:1 Splice (AWG Size)	Color Code
304–1510	0.15–0.75	26–20	Red
779–2680	0.39–1.34	20–16	Blue
1900–6755	0.95–3.37	18–12	Yellow

CMA/mm² Worksheet

Example:

Application: A butt splice with three AWG 22 wires in one side and one AWG 18 wire in the other side:

The CMA for AWG 22 wire in Table A is 754 (0.38 mm²).

Side one is therefore calculated as follows:

$$\text{CMA} = 3 \times 754 = 2262$$

$$(\text{mm}^2 = 3 \times 0.38 = 1.14)$$

The other side, where the CMA for AWG 18 is 1900, is calculated as:

$$\text{CMA} = 1 \times 1900 = 1900$$

$$(\text{mm}^2 = 1 \times 0.95 = 0.95)$$

Using Table B to select the smallest crimp barrel that will easily fit 2262 CMA (0.95 mm²), the blue barrel is the correct choice.

Wire Number	CMA	mm ²	
1	_____	_____	
2	_____	_____	
3	_____	_____	
4	_____	_____	
5	_____	_____	
6	_____	_____	
7	_____	_____	
8	_____	_____	
9	_____	_____	
10	_____	_____	
Total	_____	_____	Part Number: _____

Table C. Stub (Parallel) Splices



Illustration	Part No.		Crimp Barrel Size Range CMA [mm ²] Min.–Max.	I.D. dimensions			
	Tin Plated	Nickel Plated		Side 1		Side 2	
				Sealing Insert	Max. No. of Wires	Sealing Insert	Max. No. of Wires
	D-436-0128 Red	D-436-0119 Red	304–1510 [0.15–0.75]	 2.16 [.085]	2	 1.01 [.040]	2
	D-436-58 Blue	D-436-75 Blue	779–2680 [0.39–1.34]	 4.56 [.180]	2	 2.28 [.090]	2
	D-436-59 Yellow	D-436-76 Yellow	1900–6755 [0.95–3.37]	 4.56 [.180]	2	 2.28 [.090]	2
	D-436-60 Blue	D-436-77 Blue	779–2680 [0.39–1.34]	 2.03 [.080]	10 (2 per hole)	 6.35 [.250]	2
	D-436-61 Yellow	D-436-78 Yellow	1900–6755 [0.95–3.37]	 2.03 [.080]	10 (2 per hole)	 6.35 [.250]	2

Table D. Butt (in-line) splices



Illustration	Part No.		Crimp Barrel Size Range CMA [mm ²] Min. - Max.	I.D. dimensions			
	Tin Plated	Nickel Plated		Side 1	Max. No. of Wires	Side 2	Max. No. of Wires
	D-436-36* Red	D-436-82 Red	304-1510 [0.15-0.75]		2		2
	D-436-37* Blue	D-436-83 Blue	779-2680 [0.39-1.34]		2		2
	D-436-38* Yellow	D-436-84 Yellow	1900-6755 [0.95-3.37]		2		2
	D-436-0110 Red	D-436-85 Red	304-1510 [0.15-0.75]		6		2
	D-436-52 Blue	D-436-86 Blue	779-2680 [0.39-1.34]		6 (2 per hole)		2
	D-436-53 Yellow	D-436-87 Yellow	1900-6755 [0.95-3.37]		6 (2 per hole)		2
	D-436-0115 Red	D-436-88 Red	304-1510 [0.15-0.75]		6 (2 per hole)		6 (2 per hole)
	D-436-42 Blue	D-436-89 Blue	779-2680 [0.39-1.34]		6 (2 per hole)		6 (2 per hole)
	D-436-43 Yellow	D-436-90 Yellow	1900-6755 [0.95-3.37]		6 (2 per hole)		6 (2 per hole)

*Qualified to MIL-S-81824/1.

Table E. Crimp Barrel Only

Type	Color Code	Tin-Plated	Nickel Plated	Crimp Barrel Size Range CMA [mm ²] Min. - Max.
Butt (in-line)	Red	D-609-06	D-609-09	304-1510 [0.15-0.75]
Butt (in-line)	Blue	D-609-07	D-609-10	779-2680 [0.39-1.34]
Butt (in-line)	Yellow	D-609-08	D-609-11	1900-6755 [0.95-3.37]
Stub (Parrel)	Red	D-609-03	D-609-12	304-1510 [0.15-0.75]
Stub (Parrel)	Blue	D-609-04	D-609-13	779-2680 [0.39-1.34]
Stub (Parrel)	Yellow	D-609-05	D-609-14	1900-6755 [0.95-3.37]

Table F. Sealing Sleeve Only

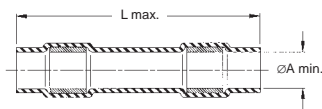

Part No.	Color Code	L Max.	A Min.
D-436-0096	Red	29.2 [1.15]	2.16 [0.085]
D-436-0097	Blue	29.2 [1.15]	2.8 [0.110]
D-436-0098	Yellow	29.2 [1.15]	4.32 [0.170]

Product Characteristics

MiniSeal High-Performance, Immersion-Resistant Crimp Splices (Continued)

Material	
Insulation	Radiation-crosslinked, heat-shrinkable polyvinylidene fluoride
Crimp barrel	Tin- or nickel-plated copper
Melttable inserts	Melttable thermoplastic
Typical Performance	
Voltage drop	6.9 mV at 4.5 A vs 8.1 mV for an equal length of wire
Tensile strength	Exceeds strength of conductor
Dielectric strength	2.5 kV
Temperature rating	-55°C to 150°C [-67°F to 302°F]
Insulation resistance	5000 megohms

Specifications/Approvals

Series	Military
D-436	MIL-S-81824/1 for D-436-36/37/38

Installation

For proper installation of these devices, the correct crimp tool (Raychem part number AD-1377) and a heating tool and reflector attachment must be used.

Any one of the following Raychem heating tools is recommended:

- HL1802E
- AA-400 Super Heater

Refer to Raychem installation procedure RCPS 200-20 for detailed instructions and recommended reflector attachments.

You will find ordering information for these tools in Section 10.



**Introduction**

Raychem insulated electrical terminal products provide reliable, repeatable, and rugged examples of terminals available. We start on the front end with terminal sizes and configurations that meet or exceed industry standards in terms of material selection, surface treatment, and electrical performance.

Here the comparison stops. What separates Raychem products from the rest of the industry are the materials and termination techniques used on the back end of the products, which provide unparalleled value.

Products include:

- ***DuraSeal heat-shrinkable nylon crimp products***, which protect against water, condensation, salt, and corrosion. Their tough, heat-shrinkable nylon tubing resists abrasion and cut-through

damage, provides strain relief, and protects against vibration damage. DuraSeal products are simple and quick to install using a crimp tool and a heat source. They accommodate a wide range of wire sizes and are color-coded for easy identification, yet are transparent for visual inspection of the finished splice.

- ***SolderGrip heat-shrinkable twist-on products***, which utilize a spiral copper coil that grips and compresses the conductors and allows a prefluxed solder ring to flow to the center of the splicing area, resulting in a highly reliable, repeatable joint. SolderGrip terminals use a durable polyvinylidene fluoride heat-shrinkable tubing that protects the electrical joint and provides insulation and strain relief. The

SolderGrip technology is a reliable means of terminating more than two conductors time after time. SolderGrip terminals can terminate a variety of conductor types (solid and stranded) and platings. Terminations on more than eight individual conductors in a single joint have been successfully demonstrated using this product.

DuraSeal product delivers protected electrical joints on industry standard terminals and is suitable for harsh environments.

Product Facts

- Resistance to moisture and abrasion
- Strain relief
- Protection from wire pull-out
- Easy installation
- UL and CUL listed 

DuraSeal Heat-Shrinkable Environmentally Sealed, Nylon Insulated Crimp Terminals and Disconnects



Applications

DuraSeal products insulate and protect electrical connections from mechanical abuse, wire pull-out, and abrasion while resisting water, salt, and other contaminants.

DuraSeal devices provide a tough, environmentally sealed wire connection. Their crimp barrel or terminal, encased in rugged, heat-shrinkable nylon tubing lined with a special hot-melt adhesive, resists damage from abrasions and cuts.

DuraSeal devices retain flexibility and impact-resistance long after similar products have become brittle.

DuraSeal devices accommodate wire gauge sizes 22 to 10. They are color-coded for easy identification of gauge sizes, yet transparent for inspection of the finished splice.

Approvals and Reference Documents

Agency approvals	UL listed component, file E87681, terminals except quick connect terminals; file E157833, quick connect terminals
Reference documents	Raychem specifications RB-108, Specification DuraSeal crimp terminals DuraSeal selection guide (H54153) DuraSeal installation guidelines (H54154)

Available in:

- Americas ■
- Europe ■
- Asia Pacific ■

DuraSeal Heat-Shrinkable Environmentally Sealed, Nylon Insulated Crimp Terminals and Disconnects (Continued)

Product Characteristics

	Property	Unit	Requirement	Method of Test
Physical	Dimensions	Inches	None	See product dimensions
	Tensile strength	Pounds	8 to 40 lbs depending on AWG	UL486C, IEC512-8
Electrical	Property	Unit	Typical value	Method of Test
	Voltage drop	Millivolts	Less than equal length of wire	MIL-S-81824, IEC512-2
	Insulation resistance	Megohms	103 min.	MIL-STD-202 method 302
	Dielectric withstand voltage	Kilovolts	2.5	MIL-STD-202F method 301, IEC512-2
Chemical	Property	Unit	Requirement	Method of Test
	Diesel fuel Brake fluid Antifreeze 5% salt water Motor oil	—	Meet electrical test listed above after conditioning.	ASTM D 3032, ESA-603D
Environmental (Fluid)	Humidity	—	Meet electrical test listed above after conditioning.	MIL-STD-202F method 106, IEC68-2-30
	Immersion	—		MIL-STD-202F condition C, IEC68-2-14 test NC
	Vibration	—		MIL-STD-202F method 201, IEC68-2-6
	Bending	—		UL486C, IEC512-8
	Thermal shock	—		MIL-STD-202F method 107, IEC68-2-14 test N
	Heat aging (168h @ 85°C [185°F]) Salt spray	—		MIL-STD-202F, IEC68-2-2 MIL-STD-202F method 101, IEC68-2-11
Operating conditions	Temperature rating	—	-55°C to +125°C [-67°F to -257°F]	None
	Minimum shrink temperature	—	180°C [356°F]	None
	Voltage rating	—	600 Volt max	None

Fork Terminals

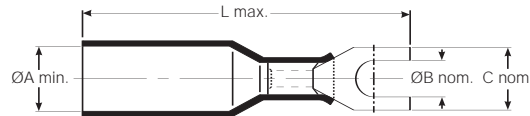

Part No.	Fork Terminal Dimensions					Color	Insulation Conductor (AWG)	Wire Dimensions	
	A Min.	Stud Size		C Nom.	L Max.			Insulation O.D. (Max.)	O.D. (Min.)
		Metric	Imperial						
B-106-2401	3.81 [.15]	M4	8	7.87 [.31]	32.00 [1.26]	Red	22-18	3.81 [.150]	1.40 [.055]
B-106-2402	4.57 [.18]	M4	8	7.87 [.31]	35.05 [1.38]	Blue	16-14	4.45 [.175]	2.00 [.080]
B-106-2403	6.35 [.25]	M4	8	7.87 [.31]	38.10 [1.50]	Yellow	12-10	6.35 [.250]	2.79 [.110]
B-106-2502	4.57 [.18]	M5	10	9.91 [.39]	35.05 [1.38]	Blue	16-14	4.45 [.175]	2.00 [.080]
B-106-2503	6.35 [.25]	M5	10	9.91 [.39]	40.15 [1.58]	Yellow	12-10	6.35 [.250]	2.79 [.110]

DuraSeal Heat-Shrinkable Environmentally Sealed, Nylon Insulated Crimp Terminals and Disconnects (Continued)

Ring Terminals

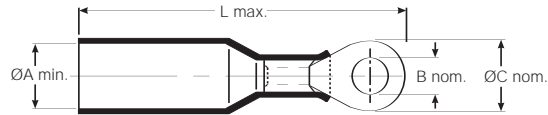

Part No.	Fork Terminal Dimensions					Color	Wire Dimensions		
	A Min.	Stud Size		C Nom.	L Max.		Insulation Conductor (AWG)	Insulation O.D. (Max.)	O.D. (Min.)
		Metric	Imperial						
B-106-1401	3.81 [.15]	M4	8	7.88 [.31]	32.00 [1.26]	Red	22-18	3.81 [.150]	1.40 [.055]
B-106-1501	3.81 [.15]	M5	10	9.91 [.39]	34.04 [1.34]	Red	22-18	3.81 [.150]	1.40 [.055]
B-106-1601	3.81 [.15]	M6	1/4	11.94 [.47]	36.07 [1.42]	Red	22-18	3.81 [.150]	1.40 [.055]
B-106-1801	3.81 [.15]	M8	5/16	13.97 [.55]	39.12 [1.54]	Red	22-18	3.81 [.150]	1.40 [.055]
B-106-1991	3.81 [.15]	M10	3/8	17.78 [.70]	43.18 [1.70]	Red	22-18	3.81 [.150]	1.40 [.055]
B-106-1402	4.57 [.18]	M4	8	7.88 [.31]	33.02 [1.30]	Blue	16-14	4.45 [.175]	2.00 [.080]
B-106-1502	4.57 [.18]	M5	10	9.91 [.39]	35.05 [1.38]	Blue	16-14	4.45 [.175]	2.00 [.080]
B-106-1602	4.57 [.18]	M6	1/4	11.94 [.47]	36.58 [1.44]	Blue	16-14	4.45 [.175]	2.00 [.080]
B-106-1802	4.57 [.18]	M8	5/16	13.97 [.55]	40.13 [1.58]	Blue	16-14	4.45 [.175]	2.00 [.080]
B-106-1992	4.57 [.18]	M10	3/8	17.78 [.70]	43.94 [1.73]	Blue	16-14	4.45 [.175]	2.00 [.080]
B-106-1403	6.35 [.25]	M4	8	7.88 [.31]	38.10 [1.50]	Yellow	12-10	6.35 [.250]	2.79 [.110]
B-106-1503	6.35 [.25]	M5	10	9.91 [.39]	40.13 [1.58]	Yellow	12-10	6.35 [.250]	2.79 [.110]
B-106-1603	6.35 [.25]	M6	1/4	11.94 [.47]	41.66 [1.64]	Yellow	12-10	6.35 [.250]	2.79 [.110]
B-106-1803	6.35 [.25]	M8	5/16	13.97 [.55]	45.21 [1.78]	Yellow	12-10	6.35 [.250]	2.79 [.110]
B-106-1993	6.35 [.25]	M10	3/8	17.78 [.70]	46.99 [1.85]	Yellow	12-10	6.35 [.250]	2.79 [.110]



DuraSeal Heat-Shrinkable Environmentally Sealed, Nylon Insulated Crimp Terminals and Disconnects (Continued)

Push-on Terminals

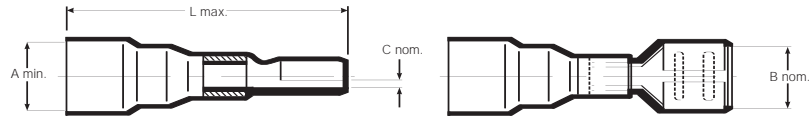

Part No.	Tab Size (inches)	Push-on Terminal Dimensions				Color	Insulation Conductor (AWG)	Wire Dimensions	
		A Min.	B Nom.	C Nom.	L Max.			Insulation O.D. (Max.)	O.D. (Min.)
B-106-3631	.250 x .032	3.81 [.150]	6.35 [.250]	.81 [.032]	30.48 [1.200]	Red	22-18	3.81 [.150]	1.40 [.055]
B-106-3632	.250 x .032	4.57 [.180]	6.35 [.250]	.81 [.032]	32.00 [1.260]	Blue	16-14	4.45 [.175]	2.00 [.080]
B-106-3633	.250 x .032	6.35 [.250]	6.35 [.250]	.81 [.032]	33.02 [1.300]	Yellow	12-10	6.35 [.250]	2.79 [.110]
B-106-3281	.110 x .020	3.81 [.150]	2.79 [.110]	.51 [.020]	22.86 [.900]	Red	22-18	3.81 [.150]	1.40 [.055]
B-106-3481	.187 x .020	3.81 [.150]	4.75 [.187]	.51 [.020]	30.48 [1.200]	Red	22-18	3.81 [.150]	1.40 [.055]

Tab Terminals

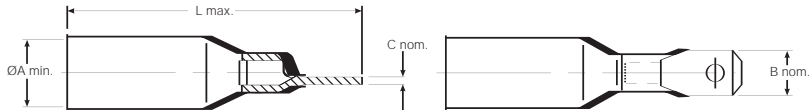

Part No.	Tab Size (inches)	Tab Terminal Dimensions				Color	Insulation Conductor (AWG)	Wire Dimensions	
		A Min.	B Nom.	C Nom.	L Max.			Insulation O.D. (Max.)	O.D. (Min.)
B-106-4631	.250 x .032	3.81 [.150]	6.35 [.250]	.81 [.032]	30.48 [1.20]	Red	22-18	3.81 [.150]	1.40 [.055]
B-106-4632	.250 x .032	4.57 [.180]	6.35 [.250]	.81 [.032]	32.00 [1.26]	Blue	16-14	4.45 [.175]	2.00 [.080]

DuraSeal Heat-Shrinkable Environmentally Sealed, Nylon Insulated Crimp Terminals and Disconnects (Continued)

Pin Terminals

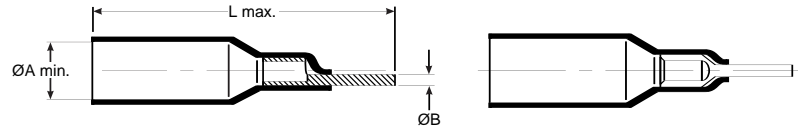

Part No.	Pin Terminal Dimensions			Color	Conductor (AWG)	Wire Dimensions	
	A Min.	B Nom.	L Max.			Insulation O.D. (Max.)	Insulation O.D. (Min.)
B-106-6201	3.81 [.150]	2.00 [.080]	30.99 [1.220]	Red	22-18	3.81 [.150]	1.40 [.055]

Bullet Terminals

Fig. 1

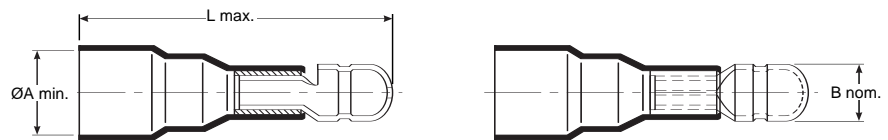
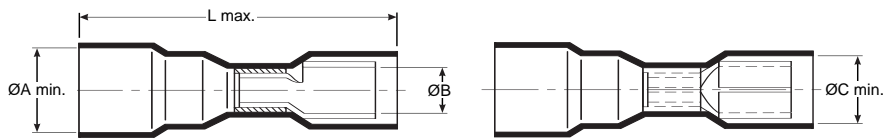

Fig. 2



Part No.	Fig.	Type	Bullet Terminal Dimensions				Color	Conductor (AWG)	Wire Dimensions	
			A Min.	B Nom.	C Min.	L Max.			Insulation O.D. (Max.)	Insulation O.D. (Min.)
B-106-7401	1	M	3.81 [.150]	3.81 [.150]	—	33.53 [1.32]	Red	22-18	3.81 [.150]	1.40 [.055]
B-106-7502	1	M	4.57 [.180]	5.08 [.200]	—	34.54 [1.36]	Blue	16-14	4.45 [.175]	2.00 [.080]
B-106-8401	2	F	3.81 [.150]	3.81 [.150]	5.59 [.220]	30.48 [1.20]	Red	22-18	3.81 [.150]	1.40 [.055]
B-106-8502	2	F	4.57 [.180]	5.08 [.200]	6.10 [.240]	32.51 [1.28]	Blue	16-14	4.45 [.175]	2.00 [.080]

8 Electrical Interconnect Products

DuraSeal Heat-Shrinkable Environmentally Sealed, Nylon Insulated Crimp Terminals and Disconnects (Continued)

Product Characteristics (Typical)

Operating temperature	-55°C to 125°C [-67°F to 257°F]
Shrink ratio	Approximately 2:1
Physical properties	Cut-through resistance: 31.7 kg [70 lb] Wire pullout after crimping and recovery: red: 11.3 kg [25 lb]; blue: 22.7 kg [50 lb]; yellow: 27.2 kg [60 lb] Not flame-retardant No cracking after heat aging for 168 hr at 160°C [320°F]
Chemical properties	Solvent resistance: isopropyl alcohol, trichloroethylene, gasoline, battery acid, diesel fuel, motor oil, antifreeze, brake fluid, 5% salt water
Electrical properties	Dielectric strength: 1000 V Insulation resistance: 10 megohms

Specifications/Approvals

Series	Agency	Raychem
B-106	UL and CUL 91J4, File E87681 Lloyd's listed, File 65 247 HH 02-93 UL and CUL E157833 (B-106-3XXX/B-106-4XXX)	RB-108

Installation

1. Select appropriate size. For terminal and disconnect terminations, strip wire 6.5 mm (1/4 inch).

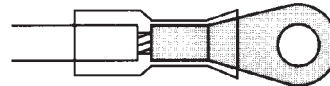

2. Crimp using Raychem AD-1522 crimp tool for preinsulated crimps.

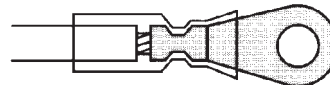

3. Heat terminal or disconnect with heat gun until tubing recovers and adhesive flows. Avoid heating ring or fork metallic parts.

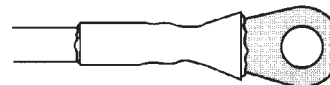

For proper installation of these devices, the correct crimp tool and heating tool with reflector attachment must be used. The Raychem AD-1522 crimp tool and HL1802E heating tool are recommended. You will find ordering information for these tools in Section 10. Refer to Raychem installation procedure RPIP 684-00 for detailed instructions.

SolderGrip Self-Fixturing Insulated Terminals

Product Facts

- Transparent insulation sleeve provides encapsulation, inspectability, strain relief, and insulation
- Spiral copper coil grips and compresses the conductors for optimum solder connection
- Prefluxed solder preform provides a controlled soldering process.
- One-piece design for easy installation
- Accommodates a wide variety of conductor types, quantities, sizes, and plating types unmatched by any other termination technique
- Parts meet the performance requirements of MIL-T-7928G

Applications

Used for terminating multiple wires to terminals.



Table A. Part Number Selection

Available in:	
Americas	■
Europe	■
Asia Pacific	■



Product option

Product Series	Environmental Protection
SGRT	Splashproof

Product Selection Process

1. Determine the wire combination (number of wires and size) of the wire bundle you wish to terminate.
2. Use Table C to select the correct terminal for AWG wire combination.* Example: For connecting a bundle with one 12 AWG wire (1 #12) and two 18 AWG wires (+ 2 #18) to a terminal, you need an SGRT-4-XX terminal.
3. Determine the correct stud size.
4. Select the correct part number from Table A for that stud size in the terminal series and size you selected in Step 2. Example: If the stud size is 1/4, select part number SGRT-4-06.
5. Verify that the wire bundle (with wire insulation) does not exceed the maximum diameter allowed for the part you selected. Simply check the bundle's diameter against the maximum diameter that Table A lists for that part.
6. Verify that the total amperage to be applied does not exceed the maximum amp rating for the part as specified in Table A.

*If the wire combination is not listed in Table B, use the CMA (mm²) method of determining wire bundle size (see "CMA/mm² Calculation" on page 8-34).

Using Table B, select the smallest size part that will fit your total wire CMA (mm²) value.

SolderGrip Part No.	Stud Size	Maximum Bundle Diameter†	Maximum Amp Rating	Wire Range (Min.-Max.) CMA [mm ²]	Typical Length
SGRT-1-02	2 [2]	4.1 [.161]	12.5 A	1400-5000 [0.7-2.5]	38 [1 1/2]
SGRT-2-03	3 [6]	5.0 [.195]	15 A	2400-6000 [1.2-3.0]	38 [1 1/2]
SGRT-2-04	4 [8]	—	15 A	2400-6000 [1.2-3.0]	38 [1 1/2]
SGRT-2-05	5 [10]	—	15 A	2400-6000 [1.2-3.0]	38 [1 1/2]
SGRT-2-06	6 [1/4]	—	15 A	2400-6000 [1.2-3.0]	38 [1 1/2]
SGRT-3-06	6 [1/4]	6.5 [.255]	33 A	5000-13,200 [2.5-6.6]	44.5 [1 3/4]
SGRT-3-08	8 [5/16]	—	33 A	5000-13,200 [2.5-6.6]	51.0 [2]
SGRT-4-06	6 [1/4]	9.0 [.355]	56 A	12,000-22,400 [6.0-11.2]	44.5 [1 3/4]
SGRT-4-08	8 [5/16]	—	56 A	12,000-22,400 [6.0-11.2]	51 [2]

†Maximum bundle diameter is measured over wire insulation.

CMA/mm² Calculation

SolderGrip Self-Fixturing Insulated Terminals (Continued)

To calculate the total circular mil or mm² area of the wire bundle to be terminated, follow these steps:

1. Choose either CMA or mm² as your unit of measure for selection purposes and continue to use it for all your selection criteria. (Both measures provide the same results.)
2. In the workspace below, list the CMA or mm² for each conductor in the bundle. (Table B provides the CMA of typical conductors.)
3. Add together the values listed in the workspace below to obtain the total area.
4. Use Table A to select the smallest terminator that will fit the total CMA (mm²).

Wire Number	CMA	mm ²	
1	_____	_____	
2	_____	_____	
3	_____	_____	
4	_____	_____	
5	_____	_____	
6	_____	_____	
7	_____	_____	
8	_____	_____	
9	_____	_____	
10	_____	_____	
			Solder Grip Part No. _____
Total			

CMA/mm² Example

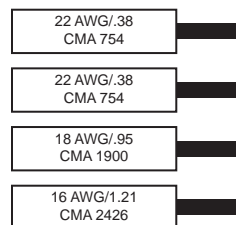

Total CMA = 5834
 Total mm² = 2.92
 Correct part number (based on CMA of 5834 or mm² of 2.92):
 SGRT-2-XX if bundle OD is less than 5.0 mm (0.195 in).

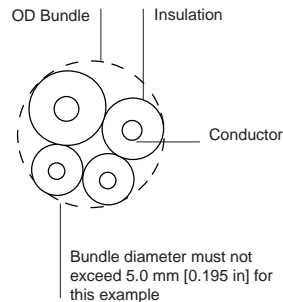

Table B. CMA of Typical Copper Conductors

Strands	7	19	19	19	19	19	19	19	37
AWG	28	26	24	22	20	18	16	14	12
CMA	177	304	475	754	1216	1900	2426	3831	5874
mm ²	0.09	0.15	0.24	0.38	0.61	0.95	1.21	1.92	2.94

Table C. SolderGrip Wire Combinations (see Table A for Terminal Size [-XX])

Wire Combinations	Part No.	Wire Combinations	Part No.	Wire Combinations	Part No.
1 # 8	SGRT-4-XX	1 # 12 + 1 # 16 + 4 # 18	SGRT-4-XX	1 # 14 + 4 # 20	SGRT-3-XX
1 # 8 + 1 # 16	SGRT-4-XX	1 # 12 + 2 # 16	SGRT-3-XX	1 # 14 + 1 # 18	SGRT-2-XX
2 # 8 + 2 # 16	SGRT-4-XX	1 # 12 + 2 # 16 + 1 # 18	SGRT-3-XX	1 # 14 + 1 # 18 + 1 # 20	SGRT-3-XX
1 # 8 + 1 # 14	SGRT-4-XX	1 # 12 + 2 # 16 + 2 # 18	SGRT-4-XX	1 # 14 + 2 # 18	SGRT-3-XX
1 # 10	SGRT-3-XX	1 # 12 + 3 # 16	SGRT-4-XX	1 # 14 + 3 # 18	SGRT-3-XX
1 # 10 + 1 to 3 # 18	SGRT-3-XX	1 # 12 + 4 # 16	SGRT-4-XX	1 # 14 + 4 # 18	SGRT-3-XX
1 # 10 + 2 # 18	SGRT-3-XX	1 # 12 + 5 # 16	SGRT-4-XX	1 # 14 + 5 # 18	SGRT-4-XX
1 # 10 + 3 # 18	SGRT-4-XX	1 # 12 + 1 # 14 + 1 # 18	SGRT-3-XX	1 # 14 + 1 # 16	SGRT-3-XX
1 # 10 + 1 # 16	SGRT-3-XX	1 # 12 + 1 # 14 + 2 # 18	SGRT-4-XX	1 # 14 + 1 # 16 + 1 # 20	SGRT-3-XX
1 # 10 + 1 # 16 + 1 # 18	SGRT-4-XX	1 # 12 + 1 # 14 + 3 # 18	SGRT-4-XX	1 # 14 + 1 # 16 + 1 # 18	SGRT-3-XX
1 # 10 + 1 # 16 + 2 # 18	SGRT-4-XX	1 # 12 + 1 # 14 + 1 # 16	SGRT-3-XX	1 # 14 + 1 # 16 + 2 # 18	SGRT-3-XX
1 # 10 + 2 # 16	SGRT-4-XX	1 # 12 + 1 # 14 + 2 # 16	SGRT-4-XX	1 # 14 + 1 # 16 + 3 # 18	SGRT-3-XX
1 # 10 + 3 # 16	SGRT-4-XX	1 # 12 + 1 # 14 + 3 # 16	SGRT-4-XX	1 # 14 + 1 # 16 + 4 # 18	SGRT-4-XX
1 # 10 + 4 # 16	SGRT-4-XX	1 # 12 + 1 # 14 + 4 # 16	SGRT-4-XX	1 # 14 + 2 # 16	SGRT-3-XX
1 # 10 + 5 # 16	SGRT-4-XX	1 # 12 + 2 # 14	SGRT-4-XX	1 # 14 + 2 # 16 + 1 # 18	SGRT-3-XX
1 # 10 + 1 # 14	SGRT-3-XX	1 # 12 + 2 # 14 + 1 # 18	SGRT-4-XX	1 # 14 + 2 # 16 + 2 # 18	SGRT-3-XX
1 # 10 + 1 # 14 + 1 # 18	SGRT-4-XX	1 # 12 + 2 # 14 + 1 # 16	SGRT-4-XX	1 # 14 + 2 # 16 + 3 # 18	SGRT-4-XX
1 # 10 + 1 # 14 + 1 # 16	SGRT-4-XX	1 # 12 + 2 # 14 + 2 # 16	SGRT-4-XX	1 # 14 + 3 # 16	SGRT-3-XX
1 # 10 + 1 # 14 + 2 # 16	SGRT-3-XX	1 # 12 + 2 # 14 + 3 # 16	SGRT-4-XX	1 # 14 + 3 # 16 + 1 # 18	SGRT-3-XX
1 # 10 + 1 # 14 + 3 # 16	SGRT-4-XX	1 # 12 + 3 # 14	SGRT-4-XX	1 # 14 + 3 # 16 + 2 # 18	SGRT-4-XX
1 # 10 + 2 # 14	SGRT-4-XX	1 # 12 + 3 # 14 + 1 # 16	SGRT-4-XX	1 # 14 + 4 # 16	SGRT-4-XX
1 # 10 + 3 # 14	SGRT-4-XX	1 # 12 + 4 # 14	SGRT-4-XX	1 # 14 + 4 # 16 + 1 # 18	SGRT-4-XX
1 # 10 + 1 # 12	SGRT-4-XX	2 # 12 + 1 # 18	SGRT-4-XX	1 # 14 + 5 # 16	SGRT-4-XX
1 # 10 + 1 # 12 + 1 # 14	SGRT-4-XX	2 # 12 + 1 # 16	SGRT-4-XX	2 # 14	SGRT-3-XX
1 # 10 + 2 # 12	SGRT-4-XX	2 # 12 + 2 # 16 + 1 # 18	SGRT-4-XX	2 # 14	SGRT-3-XX
2 # 10	SGRT-4-XX	2 # 12 + 3 # 16	SGRT-4-XX	2 # 14	SGRT-3-XX
2 # 10 + 1 # 16	SGRT-4-XX	2 # 12 + 1 # 14 + 1 # 18	SGRT-4-XX	2 # 14	SGRT-3-XX
1 # 12	SGRT-3-XX	2 # 12 + 1 # 14 + 1 # 16	SGRT-4-XX	2 # 14	SGRT-3-XX
1 # 12 + 1 # 18	SGRT-3-XX	2 # 12 + 2 # 14	SGRT-4-XX	2 # 14 + 1 # 16	SGRT-3-XX
1 # 12 + 2 # 18	SGRT-3-XX	3 # 12 + 1 # 18	SGRT-4-XX	2 # 14 + 1 # 16	SGRT-3-XX
1 # 12 + 3 # 18	SGRT-3-XX	3 # 12 + 1 # 16	SGRT-4-XX	2 # 14 + 1 # 16	SGRT-3-XX
1 # 12 + 4 # 18	SGRT-4-XX	3 # 12 + 1 # 14	SGRT-4-XX	2 # 14 + 1 # 16	SGRT-3-XX
1 # 12 + 5 # 18	SGRT-4-XX	1 # 14	SGRT-2-XX	2 # 14 + 2 # 16	SGRT-3-XX
1 # 12 + 1 # 16	SGRT-3-XX	1 # 14 + 1 # 22	SGRT-2-XX	2 # 14 + 2 # 16	SGRT-3-XX
1 # 12 + 1 # 16 + 1 # 18	SGRT-3-XX	1 # 14 + 1 # 20	SGRT-2-XX	2 # 14 + 3 # 16	SGRT-4-XX
1 # 12 + 1 # 16 + 2 # 18	SGRT-3-XX	1 # 14 + 2 # 20	SGRT-3-XX	2 # 14 + 4 # 16	SGRT-4-XX
1 # 12 + 1 # 16 + 3 # 18	SGRT-4-XX	1 # 14 + 3 # 20	SGRT-3-XX	3 # 14	SGRT-3-XX

Table C. SolderGrip Wire Combinations (see Table A for Terminal Size [-XX])
(Continued)

Wire Combinations	Part No.	Wire Combinations	Part No.	Wire Combinations	Part No.
3 # 14 + 1 # 16	SGRT-4-XX	2 # 16 + 4 # 20	SGRT-3-XX	1 # 18 + 1 # 20 + 2 # 22	SGRT-2-XX
3 # 14 + 2 # 16	SGRT-4-XX	2 # 16 + 1 # 18	SGRT-3-XX	1 # 18 + 2 # 20	SGRT-2-XX
3 # 14 + 3 # 16	SGRT-4-XX	2 # 16 + 1 # 18 + 1 # 20	SGRT-3-XX	1 # 18 + 3 # 20	SGRT-2-XX
4 # 14	SGRT-4-XX	2 # 16 + 1 # 18 + 2 # 20	SGRT-3-XX	1 # 18 + 4 # 20	SGRT-3-XX
4 # 14 + 1 # 16	SGRT-4-XX	2 # 16 + 1 # 18 + 3 # 20	SGRT-3-XX	1 # 18 + 5 # 20	SGRT-3-XX
4 # 14 + 2 # 16	SGRT-4-XX	2 # 16 + 2 # 18	SGRT-3-XX	2 # 18	SGRT-2-XX
5 # 14	SGRT-4-XX	2 # 16 + 2 # 18 + 1 # 20	SGRT-3-XX	2 # 18 + 1 # 22	SGRT-2-XX
5 # 14 + 1 # 16	SGRT-4-XX	2 # 16 + 2 # 18 + 2 # 20	SGRT-3-XX	2 # 18 + 1 # 20	SGRT-2-XX
1 # 16	SGRT-2-XX	2 # 16 + 3 # 18	SGRT-3-XX	2 # 18 + 2 # 20	SGRT-3-XX
1 # 16 + 1 # 22	SGRT-2-XX	2 # 16 + 3 # 18 + 1 # 20	SGRT-3-XX	2 # 18 + 3 # 20	SGRT-3-XX
1 # 16 + 2 # 22	SGRT-2-XX	2 # 16 + 4 # 18	SGRT-3-XX	2 # 18 + 4 # 20	SGRT-3-XX
1 # 16 + 3 # 22	SGRT-2-XX	3 # 16	SGRT-3-XX	3 # 18	SGRT-2-XX
1 # 16 + 1 # 20	SGRT-2-XX	3 # 16 + 1 # 20	SGRT-3-XX	3 # 18 + 1 # 20	SGRT-3-XX
1 # 16 + 1 # 20 + 1 # 22	SGRT-2-XX	3 # 16 + 2 # 20	SGRT-3-XX	3 # 18 + 2 # 20	SGRT-3-XX
1 # 16 + 2 # 20	SGRT-2-XX	3 # 16 + 3 # 20	SGRT-3-XX	3 # 18 + 3 # 20	SGRT-3-XX
1 # 16 + 3 # 20	SGRT-3-XX	3 # 16 + 1 # 18	SGRT-3-XX	4 # 18	SGRT-3-XX
1 # 16 + 4 # 20	SGRT-3-XX	3 # 16 + 1 # 18 + 1 # 20	SGRT-3-XX	4 # 18 + 1 # 20	SGRT-3-XX
1 # 16 + 5 # 20	SGRT-3-XX	3 # 16 + 1 # 18 + 2 # 20	SGRT-3-XX	4 # 18 + 2 # 20	SGRT-3-XX
1 # 16 + 1 # 18	SGRT-2-XX	3 # 16 + 2 # 18	SGRT-3-XX	5 # 18	SGRT-3-XX
1 # 16 + 1 # 18 + 1 # 20	SGRT-2-XX	3 # 16 + 2 # 18 + 1 # 20	SGRT-3-XX	5 # 18 + 1 # 20	SGRT-3-XX
1 # 16 + 1 # 18 + 2 # 20	SGRT-3-XX	3 # 16 + 3 # 18	SGRT-3-XX	6 # 18	SGRT-3-XX
1 # 16 + 1 # 18 + 3 # 20	SGRT-3-XX	4 # 16	SGRT-3-XX	1 # 20 + 2 # 22	SGRT-2-XX
1 # 16 + 1 # 18 + 4 # 20	SGRT-3-XX	4 # 16 + 1 # 20	SGRT-3-XX	1 # 20 + 3 # 22	SGRT-2-XX
1 # 16 + 2 # 18	SGRT-3-XX	4 # 16 + 2 # 20	SGRT-3-XX	1 # 20 + 4 # 22	SGRT-2-XX
1 # 16 + 2 # 18 + 1 # 20	SGRT-3-XX	4 # 16 + 1 # 18	SGRT-3-XX	2 # 20	SGRT-2-XX
1 # 16 + 2 # 18 + 2 # 20	SGRT-3-XX	4 # 16 + 1 # 18 + 1 # 20	SGRT-3-XX	2 # 20 + 1 # 22	SGRT-2-XX
1 # 16 + 2 # 18 + 3 # 20	SGRT-3-XX	4 # 16 + 2 # 18	SGRT-4-XX	2 # 20 + 2 # 22	SGRT-2-XX
1 # 16 + 3 # 18	SGRT-3-XX	5 # 16	SGRT-3-XX	2 # 20 + 3 # 22	SGRT-2-XX
1 # 16 + 3 # 18 + 1 # 20	SGRT-3-XX	5 # 16 + 1 # 20	SGRT-4-XX	3 # 20	SGRT-2-XX
1 # 16 + 3 # 18 + 2 # 20	SGRT-3-XX	5 # 16 + 1 # 18	SGRT-4-XX	3 # 20 + 1 # 22	SGRT-2-XX
1 # 16 + 4 # 18	SGRT-3-XX	6 # 16	SGRT-4-XX	4 # 20	SGRT-2-XX
1 # 16 + 4 # 18 + 1 # 20	SGRT-3-XX	1 # 18 + 1 # 22	SGRT-2-XX	5 # 20	SGRT-3-XX
1 # 16 + 5 # 18	SGRT-3-XX	1 # 18 + 2 # 22	SGRT-2-XX	6 # 20	SGRT-3-XX
2 # 16	SGRT-2-XX	1 # 18 + 3 # 22	SGRT-2-XX	4 # 22	SGRT-2-XX
2 # 16 + 1 # 20	SGRT-3-XX	1 # 18 + 1 # 20	SGRT-2-XX	5 # 22	SGRT-2-XX
2 # 16 + 2 # 20	SGRT-3-XX	1 # 18 + 1 # 20 + 1 # 22	SGRT-2-XX	6 # 22	SGRT-2-XX
2 # 16 + 3 # 20	SGRT-3-XX	—	—	—	—

Installation

SolderGrip Self-Fixturing Insulated Terminals (Continued)

The SolderGrip product is pushed onto the conductors with a twisting motion. With the product in place, installation can be completed with the proper selection and use of heating tools and reflectors.

Refer to Raychem installation procedure RPIP 820-01 for detailed instructions and recommended reflector attachments.

You will find ordering information for these tools in Section 10.

Either of the following Raychem heating tools is recommended:

- HL1802E
- CV-1981

Product Characteristics

Material	
Insulation	Radiation-crosslinked, heat-shrinkable polyvinylidene fluoride (Kynar®)
Solder and flux	Sn60 Pb40 with RA flux
Typical Performance	
Tensile strength	Exceeds strength of individual wires
Temperature rating	-55°C to +150°C [-67°F to +302°F]
Voltage Drop	Not to exceed that of equivalent length of wire by more than 1 mV
Dielectric Withstanding Voltage	Current leakage less than 2 mA (1.5 kV)

**Introduction**

Raychem SolderSleeve terminators offer easy, one-step solutions for wire connections to pins, posts, and tabs and for mass wire terminations.

Designed for applications with temperatures up to 150°C [302°F], the products in this section include SolderSleeve discrete wire terminators, which are heat-shrinkable thermoplastic sleeves containing a precisely engineered fluxed solder preform.

SolderSleeve terminators are also available on carrier tape, spaced precisely to match connector terminal spacing, enabling termination of an entire row of wires at one time.

SolderSleeve wire-to-pin, wire-to-post, and wire-to-tab terminators, like all Raychem termination products, provide reliability and economical installation for greater productivity. They can be supplied either in bulk or on carrier tape.

Product Facts

- Transparent polyvinylidene fluoride or polyolefin insulation sleeve provides encapsulation, inspectability, strain relief, and insulation
- Prefluxed solder preform offers a controlled soldering process
- One-piece design means easy installation and low installed cost
- Optional tape carrier provides convenience and ease of installation
- UL and CUL Recognized 

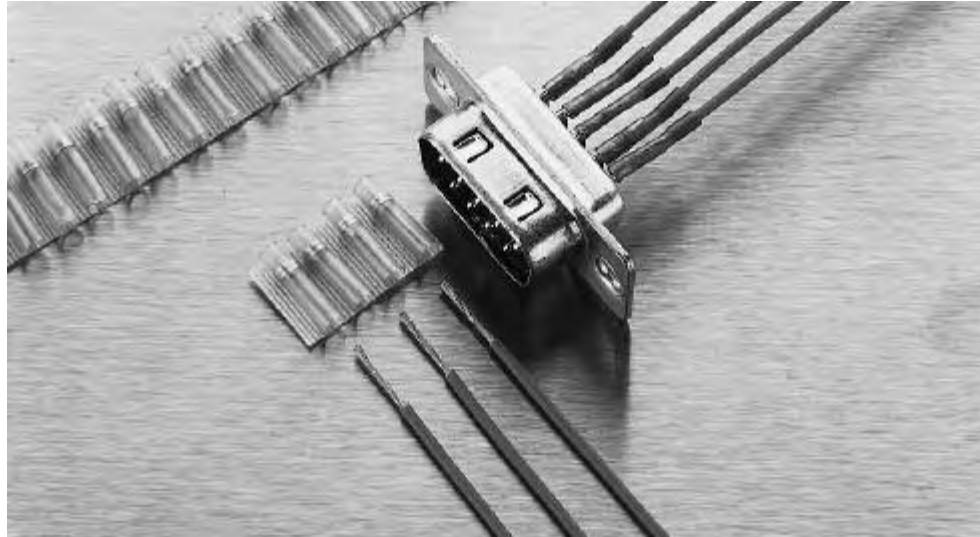

Applications

Used for terminating wires to component terminals, such as motor tabs, connector pins, and switch terminals.

Product selection process

1. Determine the application operating temperature.
2. From the Product Options table on the next page, select the product series appropriate for the application, based on the temperature required.
3. Determine your component connection point type (pin, post, or tab) and dimensions.
4. Determine your wire gauge.
5. Optional: Select tape carrier center-to-center spacing (D-71X series only). This should match center spacing of component terminals.
6. Select part number from the appropriate table:
 - For CWT series (applications with low-temperature wires—below 125°C [257°F]), use Table A.
 - For D-129/141/71X series (applications with wires rated higher than 125°C [257°F]), use Table B.

Installation

For proper installation of these devices, the correct heating tool and reflector attachment must be used. Either of the following Raychem heating tools are recommended:

- HL1802E

- AA-400 Super Heater

Refer to Raychem installation procedure RCPS 200-12 (for D-129, D-141, D-71X) or RPIP 824-00 (for CWT) for detailed instructions and recommended reflector attachment.

You will find ordering information for these tools see section 10.

Available in:

- | | |
|--------------|---|
| Americas | ■ |
| Europe | ■ |
| Asia Pacific | ■ |

Product Options

SolderSleeve Discrete Wire Terminators (Continued)

Product Series	Max. Operating Temperature	Min. Wire Temperature Rating
CWT	125°C [257°F]	85°C [185°F]
D-129, D-141, D-71X	150°C [302°F]	125°C [257°F]

Note: Cadmium-free option (B-152 series) is available for operating temperature of 125°C [257°F]. Consult Tyco Electronics for details.

Table A. CWT Series
(125°C [257°F] rated)

Connection-point Type and Size	Terminal Dimensions	Wire AWG/mm ²	Part No.
 <p>pin</p>	W = up to 0.63 [.025]	24 [0.24] 20 [0.61]	CWT-1501 CWT-1502
	W = 0.63 [.025] to 0.89 [0.035]	24 [0.24] 22 [0.38] 20 [0.61]	CWT-1501 CWT-1502 CWT-1503
	W = 0.89 [0.035] to 1.14 [.045]	24-22 [0.24-0.38] 20-18 [0.61-0.95]	CWT-1502 CWT-1503
 <p>post</p>	W = 1.14 [.045] to 1.52 [.060]	24-22 [0.24-0.38] 20-18 [0.61-0.95]	CWT-1503 CWT-1504
	W = up to 1.52 [.060]	24-20 [0.24-0.61]	CWT-1501
 <p>tab</p>	W = 1.27 [.050] to 2.28 [.090]	24-18 [0.24-0.95]	CWT-1502
	W = 1.77 [.070] to 2.79 [.110]	24-18 [0.24-0.95]	CWT-1503
	W = 2.54 [.100] to 3.80 [.150]	24-18 [0.24-0.95]	CWT-1504
	W = 2.28 [.090] to 4.70 [.187]	22-16 [0.38-1.21]	CWT-1505

Table B. D-129/141/71X Series
(up to 150°C [302°F] rated)

Connection-point
Type and Size

Terminal Dimensions		Wire		Tape Carrier Spacing of Sleeves (Center-to-Center)				
		AWG	mm ²	None	1.27 [0.050]	2.54 [0.100]	3.17 [0.125]	4.0 [0.156]
 pin	W = up to 0.61 [.024]	30–26	[0.05–0.15]	D-141-30	D-713-03	—	—	—
	W = 0.63 [.025] to 0.81 [.032]	24–22	[0.24–0.38]	D-141-07	—	D-711-00	—	—
 post	W = 0.76 [.030] to 1.27 [.050]	20	[0.61]	D-141-31	—	D-711-04	D-711-07	D-711-08
	W = up to 1.52 [.060]	24–20	[0.24–0.61]	D-141-56	—	—	—	—
 tab	W = 1.27 [.050] to 2.28 [.090]	24–20	[0.24–0.61]	D-129-05	—	D-714-01	—	—
	W = 2.28 [.090] to 3.55 [.140]	24–20	[0.24–0.61]	D-129-03	—	—	—	D-714-00

For Fine Wire Terminations
0.15 mm² (26 AWG) and
Smaller*

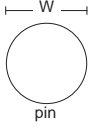
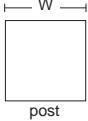
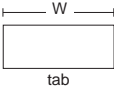
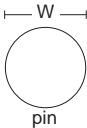
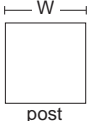
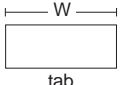
Part No.*	Inside Diameter As Supplied**	Fully Recovered†	Length††
D-110-0062	1.0 [0.040]	0.6 [0.025]	16.0 [0.630]
D-110-0217	1.0 [0.040]	0.6 [0.025]	9.0 [0.360]
D-141-13	0.75 x 1.65 [0.030 X 0.065]	0.75 [0.030]	4.7 [0.185]
D-141-22	0.75 x 1.65 [0.030 X 0.065]	0.75 [0.030]	6.0 [0.240]
D-141-30	0.75 x 1.65 [0.030 X 0.065]	0.75 [0.030]	9.5 [0.375]

Note: Micro SolderSleeve terminators are used for attaching leads smaller than 26 AWG (0.15 mm²) to terminals less than 0.6 [.025] wide.

*The D-110 series sleeves are primarily for single wire terminations and do not have a wire stop. The D-141 series will accept either one or two wires; the parts have a built-in wire stop that will locate the wire approximately 0.76 [0.03] from bottom of terminal.

**Minimum. Wire insulation must be smaller than this. When using the D-141 parts for two-wire terminations, the combined wire insulation diameters must be less than 1.5 [.060].

†Maximum. The combination of conductor diameter and terminal width and the wire insulation must be greater than this.

††The terminal length should be at least 1.2 [0.05] shorter than this. The wire strip length must be adjusted so that, when terminated, the exposed conductor is covered by the sleeve.

Product Characteristics

SolderSleeve Discrete Wire Terminators (Continued)

Material	
Insulation [D-129, D-141, D-71X]	Radiation-crosslinked, heat-shrinkable polyvinylidene fluoride
Insulation [CWT]	Radiation-crosslinked, heat-shrinkable polyolefin
Solder and flux [D-129, D-141, D-71X]	Solder: Sn63 Pb37 Flux: ROL1 per ANSI -J - 004 [RMA flux]
Solder and flux [CWT]	Solder: Sn50 Pb32 Cd 18 Flux: ROM1 per ANSI -J - 004 [RA flux]
Typical Performance	
Voltage drop	2.0 mV
Tensile strength	Exceeds strength of conductor
Dielectric strength	2.0 kV
Temperature rating [CWT]	-55°C to 125°C [-67°F to 257°F]
Temperature rating [D-129, D-141, D-71X]	-55°C to 150°C [-67°F to 302°F]
Insulation resistance	1000 megohms

Specifications/Approvals

Series	Agency	Raychem
CWT	UL and CUL E87681	D-5023
D-129, D-141	UL and CUL E87681	RT-1404

**Introduction**

Raychem SolderSleeve shield grounding terminators provide an environmentally sealed, insulated, and encapsulated solder connection for a variety of applications. SolderSleeve terminators are available in many styles.

Designed for a wide variety of temperature applications ranging from -65°C to 200°C [-85°F to 392°F], the products in this section include:

- CWT-X SolderSleeve terminators, designed for low-temperature cables with operating temperatures up to 125°C [257°F] and suitable for most commercial environments.
- MIL-S-83519 SolderSleeve terminators, which are immersion resistant and available with or without a preinstalled ground lead.
- SO Series SolderSleeve terminators, which also are immersion resistant and feature the Raychem BiAlloy temperature indication system.

All SolderSleeve products are reliable, versatile, and easy to install, resulting in lower installed costs.

SolderSleeve Shield Terminators

Product Facts

- Transparent insulation sleeve provides encapsulation, inspectability, strain relief, and insulation
- Prefluxed solder preform provides a controlled soldering process
- One-piece design offers easy installation and lower installed cost
- Optional preinstalled ground leads provide convenience and ease of installation

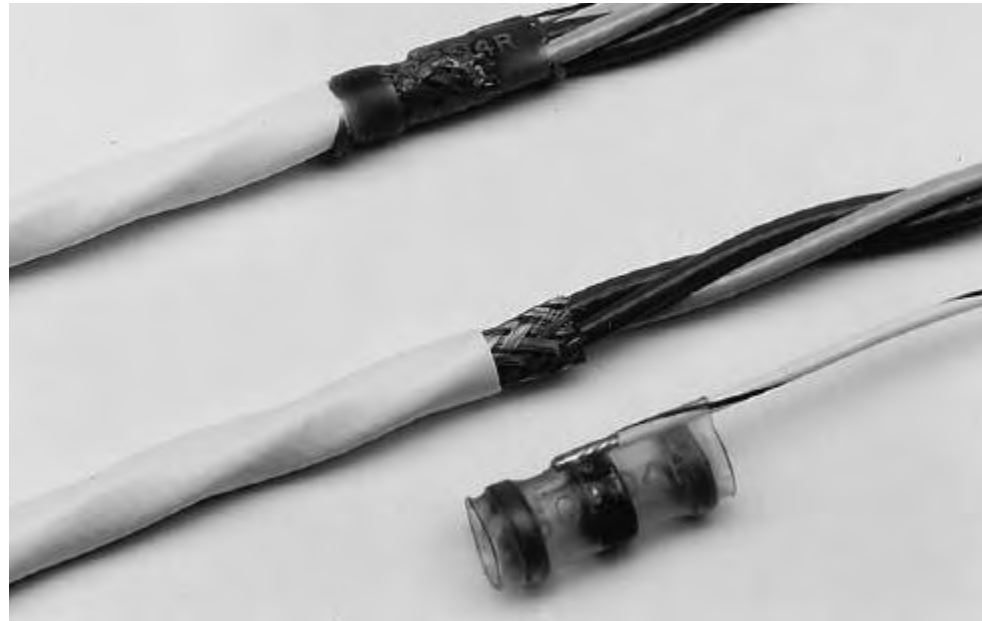

Applications

Used for shield-to-ground termination.

Product Selection Process

1. Select product series from the Product Options table below.
2. Determine cable dimensions.
3. Optional: Select preinstalled wire lead type (see Table G on page 8-47 for type descriptions).
4. Select part number (use the selection table indicated for your product series in the Product Options table below).
5. Refer to Table H on page 8-49 for cross-reference information.

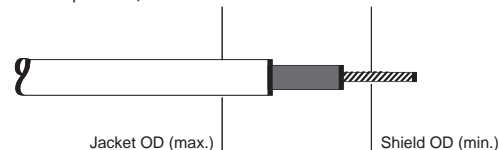

Product Options (Refer to Table G on Page 8-47 for Additional Information)

Product Series	System Oper. Temperature (Max.)	Used on Cables Rated (Min.)	Environmental Protection	Solder Alloy	Flux Type	Insulation Material	Part No. Selection Table
CWT	125°C [257°F]	85°C [185°F]	Splash resistant	Cd18	RA	Polyolefin	A
SO63*	150°C [302°F]	125°C [257°F]	Immersion resistant	Sn63	RMA	Polyvinylidene fluoride	B
S01/S02**, S03	150°C [302°F]	125°C [257°F]	Immersion resistant	Sn63	RMA	Polyvinylidene fluoride	C, D
SO96***	175°C [347°F]	150°C [302°F]	Immersion resistant	Sn96	RA	Polyvinylidene fluoride	E
SO175****	175°C [347°F]	150°C [302°F]	Immersion resistant	Sn96	RA	Polyvinylidene fluoride	F

*Meets performance requirements of SAE-AS83519 (formerly MIL-S-83519) and NAS 1747, supplied with BiAlloy temperature indicator.

**Qualified to SAE-AS83519 (formerly MIL-S-83519), supplied with thermochromic temperature indicator.

***Meets performance requirements of SAE-AS83519 (formerly MIL-S-83519) and NAS 1747, supplied with thermochromic temperature indicator.

****Meets performance requirements of SAE-AS83519 (formerly MIL-S-83519), supplied with BiAlloy temperature indicator.

Note: Cadmium-free option (B-152 series) is available for operating temperature of 125°C [257°F]. Consult Tyco Electronics for details.

Available in:

- Americas ■
- Europe ■
- Asia Pacific ■

Table A. CWT Series
(125°C [257°F] rated)

Cable OD		Part Nos.	
Jacket OD Max.	Shield OD Min.	No Preinstalled Lead	With Preinstalled Lead (22AWG/0.38 mm ² green)
1.7 [.065]	0.9 [.035]	CWT-3801	—
1.95 [.075]	1.1 [.043]	CWT-3802	—
2.7 [.105]	1.5 [.059]	CWT-3	CWT-3-W122-5
4.5 [.180]	2.0 [.079]	CWT-5	CWT-5-W122-5
6.0 [.235]	3.3 [.130]	CWT-6	CWT-6-W122-5
7.0 [.275]	3.3 [.130]	CWT-7	CWT-7-W122-5
8.7 [.340]	4.5 [.177]	CWT-9	CWT-9-W122-5
10.7 [.420]	4.5 [.177]	CWT-11	CWT-11-W122-5
13.0 [.510]	7.0 [.276]	CWT-13	CWT-13-W122-5

*See Table G on page 8-47 for lead description.

Note: The CWT series is suitable for applications using low-temperature wires (typically rated at 85°C [185°F] to 125°C [257°F]) with bare copper or tin plating.

Table B. SO63 Series

BiAlloy Temperature Indication System

This system greatly enhances the reliability and repeatability of SO63 series terminators while reducing installed cost. The heat-shrinkable thermoplastic sleeve contains a precisely engineered, fluxed solder band that is visible through the sleeve. The band provides exactly the amount of solder and flux required to terminate the ground lead to the cable shield. Encircling the band is a small temperature indicator ring. This ring melts only when the surfaces to be joined have reached the correct soldering temperature, thus ensuring a properly soldered connection. Process control is built into each sleeve.

Cable OD		No Preinstalled Lead	Part Nos.				Braid Strap	
Jacket OD Max.	Shield OD Min.		Preinstalled Lead Option*				Nickel Plated	Tin Plated
			20 AWG	22 AWG	24 AWG	26 AWG		
1.95 [0.075]	0.90 [.035]	SO63-1-00	SO63-1-55-20-90	SO63-1-55-22-90	SO63-1-55-24-90	SO63-1-55-26-90	SO63-1-01	SO63-1-9030
2.7 [0.105]	1.40 [.055]	SO63-2-00	SO63-2-55-20-90	SO63-2-55-22-90	SO63-2-55-24-90	SO63-2-55-26-90	SO63-2-01	SO63-2-9030
4.3 [0.170]	2.15 [.085]	SO63-3-00	SO63-3-55-20-90	SO63-3-55-22-90	SO63-3-55-24-90	SO63-3-55-26-90	SO63-3-01	SO63-3-9030
6.0 [0.235]	3.30 [.130]	SO63-4-00	SO63-4-55-20-90	SO63-4-55-22-90	SO63-4-55-24-90	SO63-4-55-26-90	SO63-4-01	SO63-4-9030
7.0 [0.275]	4.30 [.170]	SO63-5-00	SO63-5-55-20-90	SO63-5-55-22-90	SO63-5-55-24-90	SO63-5-55-26-90	SO63-5-01	SO63-5-9030

*See Table G on page 8-47 for lead description. Color of wire lead is denoted by the last two digits of the part number as follows:

90 = White with a black stripe 9 = White 0 = Black 6 = Blue (24 AWG only) 5 = Green (20, 22, 24 AWG)

The SO63 series is immersion resistant, features the Raychem BiAlloy temperature indication system, and meets the performance requirements of SAE-AS83519 (formerly MIL-S-83519) .

Table C. S01/S02 M83519 Series

SolderSleeve Shield Terminators (Continued)

Thermochromic Temperature Indicator

The M83519 (S01 and S02) series terminators contain a colored thermochromic temperature indicator that exhibits a distinct color change when surfaces have reached wetting temperature. This color change gives both manufacturing and Quality Control an aid in the inspection of the completed termination.

Cable OD		Part No. (MIL Part Number and Raychem Part No.) by Lead Option					
Jacket OD Max	Shield OD Min	No Preinstalled Lead		Preinstalled Lead Option*			
		MIL	Raychem	20 AWG		22 AWG	
				MIL	Raychem	MIL	Raychem
1.95 [0.075]	0.9 [.035]	M83519/1-1	S01-01-R	M83519/2-1	S02-01-R	M83519/2-6	S02-06-R
2.7[0.105]	1.40 [.055]	M83519/1-2	S01-02-R	M83519/2-2	S02-02-R	M83519/2-7	S02-07-R
4.3 [0.170]	2.15 [.085]	M83519/1-3	S01-03-R	M83519/2-3	S02-03-R	M83519/2-8	S02-08-R
6.0 [0.235]	3.30 [.130]	M83519/1-4	S01-04-R	M83519/2-4	S02-04-R	M83519/2-9	S02-09-R
7.0 [0.275]	4.30 [.170]	M83519/1-5	S01-05-R	M83519/2-5	S02-05-R	M83519/2-10	S02-10-R
Jacket OD Max.	Shield OD Min.	Preinstalled Lead Option*					
				24 AWG		26 AWG	
1.95 [0.075]	0.9 [.035]			M83519/2-11	S02-11-R	M83519/2-16	S02-16-R
2.7 [0.105]	1.40 [.055]			M83519/2-12	S02-12-R	M83519/2-17	S02-17-R
4.3[0.170]	2.15 [.085]			M83519/2-13	S02-13-R	M83519/2-18	S02-18-R
6.0 [0.235]	3.30 [.130]			M83519/2-14	S02-14-R	M83519/2-19	S02-19-R
7.0 [0.275]	4.30 [.170]			M83519/2-15	S02-15-R	M83519/2-20	S02-20-R

*See Table G for lead description.

M83519 is the qualified product listed in SAE-AS83519 (formerly MIL-S-83519) . The series features a thermochromic temperature indicator to assist in termination and inspection. The Raychem part number is permanently marked on the sleeve.

Table D. S03 Series

Thermochromic Temperature Indicator

The S03 series terminators contain a colored thermochromic temperature indicator that exhibits a distinct color change when surfaces have reached wetting temperature. This color change gives both Manufacturing and Quality Control an aid in the inspection of the completed termination.

Cable OD		Part No.	
Jacket OD Max.	Shield OD Min.	Preinstalled Lead Option*	
		Tin plated Braid Strap	Nickel plated Braid Strap
1.95 [0.075]	0.9 [.035]	S03-01-R	S03-06-R
2.7 [0.105]	1.40 [.055]	S03-02-R	S03-07-R
4.3 [0.170]	2.15 [.085]	S03-03-R	S03-08-R
6.0 [0.235]	3.30 [.130]	S03-04-R	S03-09-R
7.0 [0.275]	4.30 [.170]	S03-05-R	S03-10-R

*See Table G for lead description.

Table E. SO96 Series
(175°C [347°F] rated)

**Thermochromic
Temperature Indicator**

The SO96 series terminators contain a colored thermochromic temperature indicator that exhibits a distinct color change when surfaces have reached wetting temperature. This color change gives both manufacturing and Quality Control an aid in the inspection of the completed termination.

Cable OD		Part No.		
Jacket OD Max.	Shield OD Min.	No Preinstalled Lead	Preinstalled Lead Option*	
			22 AWG	Braid Strap
1.95 [0.075]	0.9 [0.035]	SO96-1-00	SO96-1-55-22-90	SO96-1-01
2.7 [0.105]	1.40 [0.055]	SO96-2-00	SO96-2-55-22-90	SO96-2-01
4.3 [0.170]	2.15 [0.085]	SO96-3-00	SO96-3-55-22-90	SO96-3-01
6.0 [0.235]	3.30 [0.130]	SO96-4-00	SO96-4-55-22-90	SO96-4-01
7.0 [0.275]	4.30 [0.170]	SO96-5-00	SO96-5-55-22-90	SO96-5-01

*See Table G for lead description.

The SO96 series is designed for high-temperature applications with operating temperature requirements up to 200°C [392°F]. This series features a thermochromic temperature indicator and meets performance requirements of SAE-AS83519 (formerly MIL-S-83519). The solder is Sn96 with RA flux compatible with nickel-plated shields.

Table F. SO175 Series
(175°C [347°F] rated)

BiAlloy Temperature Indication System

This system greatly enhances the reliability and repeatability of SO175 series terminators while reducing installed cost. The temperature indicator ring, encircling the solder preform, melts to indicate the very minimum amount of heat.

Cable OD		Part No.		
Jacket OD Max.	Shield OD Min.	No Preinstalled Lead	Preinstalled Lead Option*	
			22 AWG	Braid Strap
1.95 [0.075]	0.90 [0.035]	SO175-1-00	SO175-1-1-55-22-90	SO175-1-01
2.7 [0.105]	1.40 [0.055]	SO175-2-00	SO175-2-1-55-22-90	SO175-2-01
4.3 [0.170]	2.15 [0.085]	SO175-3-00	SO175-3-1-55-22-90	SO175-3-01
6.0 [0.235]	3.30 [0.130]	SO175-4-00	SO175-4-1-55-22-90	SO175-4-01
7.0 [0.275]	4.30 [0.170]	SO175-5-00	SO175-5-1-55-22-90	SO175-5-01

*See Table G for lead description.

Table G. Preinstalled Lead Description

Series	Lead Type	Remarks	Plating	Stranding	Min. Length
M83519, SO63	55A0111	MIL-W-22759/32	Tin	Stranded	150 [6.00]
SO96, SO175	55A0813	MIL-W-22759/41	Nickel	Stranded	150 [6.00]
SO63, SO96, S03	Braid strap	Uninsulated	Nickel	40 x 38 AWG	150 [6.00]
CWT	XL polyethylene	UL Listed	Tin	Stranded (W1)	150 [6.00]
SO63, S03	Braid Strap	Uninsulated	Tin	Stranded	150 [6.00]

Product Characteristics

Shield Termination

Solder Sleeve Shield Terminators (Continued)

Material		
Insulation		
SO, M83519	Radiation-crosslinked, heat-shrinkable polyvinylidene fluoride	
CWT	Radiation-crosslinked, heat-shrinkable polyolefin	
Solder and flux		
SO63, M83519, S03	Solder: Sn63 Pb37	Flux: ROL1 per ANSI - J - 004 (RMA Flux)
SO96, SO175 series	Solder: Sn96 Ag4	Flux: ROM1 per ANSI - J - 004 (RA Flux)
CWT	Solder: Sn50 Pb32 Cd18	Flux: ROM1 per ANSI - J - 004 (RA Flux)
Ground lead		
CWT series	XL polyethylene	
SO, M83519, SO175	MIL-W-22759/32 or /41	
Typical Performance		
Voltage drop	2.5 mV	
Tensile strength	Exceeds strength of ground lead	
Dielectric strength	1.0 kV immersed	
Temperature rating		
CWT	-55°C to 125°C [-67°F to 257°F]	
SO63/M83519/S03	-55°C to 150°C [-67°F to 302°F]	
SO96/SO175 series	-55°C to 175°C [-67°F to 347°F]	
Insulation resistance	1000 megohms	

Specifications/Approvals

Series	Agency	Raychem
CWT	—	D-5023
SO63*	NAS 1747	RT-1404
M83519**	MIL-S-83519/1&2	RT-1404
SO96***	NAS 1747	RT-1404
SO175		RT-1404

* Meets performance requirements of SAE-AS83519 (formerly MIL-S-83519) and NAS 1747, supplied with BiAlloy temperature indicator.

** Qualified to SAE-AS83519 (formerly MIL-S-83519), supplied with thermochromic temperature indicator.

***Meets performance requirements of SAE-AS83519 (formerly MIL-S-83519) and NAS 1747, supplied with thermochromic temperature indicator.

Installation

For proper installation of these devices, the correct heating tool and reflector attachment must be used. Any one of the following Raychem heating tools is recommended:

- HL1802E
- AA-400 Super Heater
- CV-1981
- MiniRay
- IR-1759

For detailed instructions and recommended reflector attachments, refer to the appropriate Raychem installation procedure:

Series	Procedure
CWT	RPIP 655-00-D
SO63	RCPS 100-70
M83519 (S01/S02)	RCPS 100-70
SO96	RCPS 100-70
S03	RCPS 100-70
SO175	RCPS-100-70

You will find ordering information for these tools in section 10.

Table H. NAS, M83519, and Raychem Cross-Reference

SolderSleeve Shield Terminators (Continued)

NAS Part No.	Raychem D Series Part No.	NAS Comment
1744-1	D-1744-01	
1744-2	D-1744-02	
1744-3	D-1744-03	
1744-4	D-1744-04	
1744-5	D-1744-05	
1744-6	D-1744-06	
1744-7	D-1744-07	
1744-8	D-1744-08	
1745-1	D-144-25	Inactive, Use SAE-AS83519/1-1 (formerly MIL-S-83519)
1745-2	D-100-00	Inactive, Use SAE-AS83519/1-2 (formerly MIL-S-83519)
1745-3	D-101-00	Inactive, Use SAE-AS83519/1-3 (formerly MIL-S-83519)
1745-4	D-103-00	Inactive, Use SAE-AS83519/1-5 (formerly MIL-S-83519)
1745-5	D-144-26	
1745-6	D-100-31	
1745-7	D-101-31	
1745-8	D-103-31	
1745-9		Obsolete - Use NAS1745-13
1745-10		Obsolete - Use NAS1745-14
1745-11		Obsolete - Use NAS1745-15
1745-12		Obsolete - Use NAS1745-16
1745-13	D-142-83	Inactive, Use SAE-AS83519/1-1 (formerly MIL-S-83519)
1745-14	D-142-50	Inactive, Use SAE-AS83519/1-2 (formerly MIL-S-83519)
1745-15	D-142-51	Inactive, Use SAE-AS83519/1-3 (formerly MIL-S-83519)
1745-16	D-142-52	Inactive, Use SAE-AS83519/1-5 (formerly MIL-S-83519)
1745-17	D-107-00	Inactive, Use SAE-AS83519/1-4 (formerly MIL-S-83519)
1745-18	D-104-00	
1745-19	D-105-00	
1745-20	D-107-31	
1745-21	D-104-31	
1745-22	D-105-31	
1745-23	D-142-56	Inactive, Use SAE-AS83519/1-4 (formerly MIL-S-83519)
1745-24	D-142-65	
1745-25	D-142-66	
1746-1	D-144-25	Inactive, Use SAE-AS83519/1-1 (formerly MIL-S-83519)
1746-2	D-144-00	Inactive, Use SAE-AS83519/1-2 (formerly MIL-S-83519)
1746-3	D-144-01	Inactive, Use SAE-AS83519/1-3 (formerly MIL-S-83519)
1746-4	D-144-02	Inactive, Use SAE-AS83519/1-5 (formerly MIL-S-83519)
1746-5	D-144-26	
1746-6	D-144-03	
1746-7	D-144-04	
1746-8	D-144-05	
1746-9	D-144-46	Inactive, Use SAE-AS83519/1-4 (formerly MIL-S-83519)
1746-10	D-144-37	
Military Part No.	Raychem S01/S02 Series* Part No.	Raychem SO63 Series** Part No.
M83519/1-1	S01-01-R	SO63-1-00
M83519/1-2	S01-02-R	SO63-2-00
M83519/1-3	S01-03-R	SO63-3-00
M83519/1-4	S01-04-R	SO63-4-00
M83519/1-5	S01-05-R	SO63-5-00
M83519/2-1	S02-01-R	SO63-1-55-20-90
M83519/2-2	S02-02-R	SO63-2-55-20-90
M83519/2-3	S02-03-R	SO63-3-55-20-90
M83519/2-4	S02-04-R	SO63-4-55-20-90
M83519/2-5	S02-05-R	SO63-5-55-20-90
M83519/2-6	S02-06-R	SO63-1-55-22-90
M83519/2-7	S02-07-R	SO63-2-55-22-90
M83519/2-8	S02-08-R	SO63-3-55-22-90
M83519/2-9	S02-09-R	SO63-4-55-22-90
M83519/2-10	S02-10-R	SO63-5-55-22-90
M83519/2-11	S02-11-R	SO63-1-55-24-90
M83519/2-12	S02-12-R	SO63-2-55-24-90
M83519/2-13	S02-13-R	SO63-3-55-24-90
M83519/2-14	S02-14-R	SO63-4-55-24-90
M83519/2-15	S02-15-R	SO63-5-55-24-90
M83519/2-16	S02-16-R	SO63-1-55-26-90
M83519/2-17	S02-17-R	SO63-2-55-26-90
M83519/2-18	S02-18-R	SO63-3-55-26-90
M83519/2-19	S02-19-R	SO63-4-55-26-90
M83519/2-20	S02-20-R	SO63-5-55-26-90

* QPL listed to SAE-AS83519 (formerly MIL-S-83519)

** Meets performance requirements of SAE-AS83519 (formerly MIL-S-83519)

**Introduction**

Raychem SolderSleeve coaxial cable terminators allow reliable, easy terminations in a variety of coaxial cable applications, including printed circuit boards (PCBs). The insulating and strain-relieving capabilities of SolderSleeve terminators provide the ideal solution to center-conductor breakage problems.

Designed for applications with temperatures up to 150°C [302°F], the products in this section include:

- SolderSleeve coaxial cable terminators, which allow reliable, economical attachment of coaxial cable to connector terminals, printed wiring assemblies, or solderless wrap terminals.

- One-piece SolderSleeve PCB coaxial cable terminators, which permit quick, easy, and cost-effective terminations of coaxial cable to printed circuit boards.
- RF one-step BNC/TNC connectors, which are single-piece assemblies for terminating the center conductor and the braid of a broad range of coaxial cables. They are fully intermateable with MIL-C-39012C connectors and are available in 50-ohm and 75-ohm versions (refer to pages 8-55 to 8-60 for product information).

With precisely measured solder and flux, SolderSleeve products provide exact process control of terminations. The SolderSleeve method means strong connections with the lowest possible voltage drop. Small, lightweight SolderSleeve terminators are also the ideal solution for high-density packaging problems.

SolderSleeve Coaxial Cable Terminators

Product Facts

- Transparent polyvinylidene fluoride or polyolefin insulation sleeve provides encapsulation, inspectability, strain relief (eliminates center conductor breakage), and insulation.
- Prefluxed solder preform provides a controlled soldering process
- One-piece design provides easy installation and lower installed cost
- Preinstalled termination leads provide convenience and ease of installation

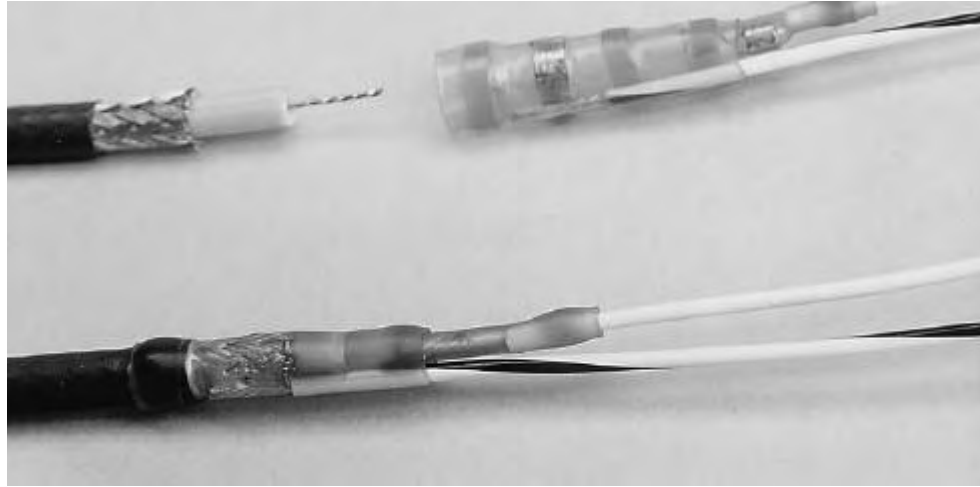

Applications

Used for terminating coaxial cable to component terminals, contacts, printed circuit boards, and solderless wrap terminals.

Product Selection Process

1. Select product series from the product options table below.
2. Select preinstalled lead type from the table below.
3. Determine cable RG number or dimensions.
4. Select part number from Table A (CWT series) or Table B (B-02X/B-04X series) on the next page.

Product Options

Product Series	Max. Operating Temp.	Use on Cables Rated (Min)	Cable Shield Plating	Part No. Selection Table	Design
CWT	125°C [257°F]	85°C [185°F]	Tin, copper	A	2-pc.
B-02X/B-04X	150°C [302°F]	125°C [257°F]	Tin, silver	B	1-pc.
D-181	150°C [302°F]	125°C [257°F]	Tin, silver	C	2-pc.
D-184	125°C [257°F]	85°C [185°F]	Tin	D	2-pc.

Preinstalled Lead Descriptions

Series	Lead Type	Plating	Stranding	AWG	Length	Color
CWT	XL polyethelene	Tin	Stranded (W1)	22	150 [6.000]	White (cntr), green (grnd)
B-021	M81822/13 (solderless wrap)	Silver	Solid-OFHC	24—30	150 [6.000]	White (cntr), blue (grnd)
B-041	M81822/13 (solderless wrap)	Silver	Solid-OFHC	24—30	150 [6.000]	White (cntr), blue (grnd)
B-043	M81822/13 (solderless wrap)	Silver	Solid-OFHC	24—30	150 [6.000]	White (cntr), blue (grnd)
B-020	55A0111 (MIL-W-22759/32)	Tin	Stranded	20—30	150 [6.000]	White (cntr), blue (grnd)
B-040	55A0111 (MIL-W-22759/32)	Tin	Stranded	20—30	150 [6.000]	White (cntr), blue (grnd)
B-044	55A0111 (MIL-W-22759/32)	Tin	Stranded	20—30	150 [6.000]	White (cntr), blue (grnd)
D-181-12XX	55A0111 (MIL-W-22759/32)	Tin	Stranded	20—30	150 [6.000]	White (cntr), white w/black stripe (grnd)
D-181-22XX	55A0111 (MIL-W-22759/32)	Tin	Stranded	20—30	150 [6.000]	White (cntr), white w/black stripe (grnd)
D-181-32XX	55A0111 (MIL-W-22759/32)	Tin	Stranded	20—30	150 [6.000]	White (cntr), white w/black stripe (grnd)
D-181-18XX	M81822/13	Silver	Solid	26 – 30	150 [6.000]	White (cntr), blue (grnd)
D-181-28XX	M81822/13	Silver	Solid	26 – 30	150 [6.000]	White (cntr), blue (grnd)
D-184	55A0111 (MIL-W-22759/32)	Tin	Stranded	20 – 26	150 [6.000]	White (cntr), white w/black stripe (grnd)

Product Characteristics

Material	
Insulation (B-02X/B-04X, D-181, D-184)	Radiation-crosslinked, heat-shrinkable polyvinylidene fluoride
Insulation (CWT series)	Radiation-crosslinked, heat-shrinkable polyolefin
Solder and flux (B-02X/B-04X, D-181)	Solder: Sn63 Pb37 Flux: ROL1 per ANSI-J-004 (RMA Flux)
Solder and flux (CWT series, D-184)	Solder: Sn50 Pb32 Cd18 Flux: ROM1 per ANSI-J-004 (RA Flux)
Typical Performance	
Voltage drop	2.0 mV
Tensile strength	Exceeds strength of conductor
Dielectric strength	2.0 kV
Temperature rating (CWT, D-184)	-55°C to 125°C [-67°F to 257°F]
Temperature rating (B-02X/B-04X, D-181)	-55°C to 150°C [-67°F to 302°F]
Insulation resistance	1000 megohms

Available in:

- Americas ■
- Europe ■
- Asia Pacific ■

Catalog 1654025
Revised 12-04

www.tycoelectronics.com

Dimensions are in millimeters and inches unless otherwise specified. Values in brackets are U.S. equivalents.

Dimensions are shown for reference purposes only. Specifications subject to change.

USA: 1-800-522-6752
Canada: 1-905-470-4425
Mexico: 01-800-733-8926
C. America: 52-55-5-729-0425

South America: 55-11-3611-1514
Japan: 81-44-900-5102
Singapore: 65-4866-151
UK: 44-1793-528171

Table A. CWT Series Part Numbers

SolderSleeve Coaxial Cable Terminators (Continued)

Cable RG Number	Dimensions		Part No. With Preinstalled Lead AWG/0.38 mm ² Green/White)
	Dielectric OD	Jacket OD	
174	0.80-2.30 [.032-.091]	1.30-2.80 [.051-.110]	CWT-4174-W122-5/9
58, 122	2.00-2.80 [.079-.110]	2.50-4.40 [.100-.173]	CWT-4058-W122-5/9
59	2.80-3.30 [.110-.130]	3.20-6.00 [.125-.235]	CWT-4059-W122-5/9

Table B. B-02X/B-04X Series Part Numbers

Part 1: Coaxial Product Group Selection

RG Cable Number	Typical Compatible Part No. Raychem Cable Description	Dimension Range					One-Piece Coaxial Product Group
		Jacket OD (Max.)	Shield OD	Dielectric OD	Conductor OD		
RG178, RG404	5030A13XX 5028A13XX	3.40 [.134]	1.30-2.30 [.051-.091]	0.50-1.70 [.019-.067]	0.30-0.80 [.011-.032]		Group 1
RG179, RG316	5024A13XX 7530A13XX 7526A13XX 9530A13XX	4.40 [.173]	1.50-2.80 [.060-.110]	1.20-2.50 [.047-.100]	0.30-1.60 [.011-.063]		Group 2
RG180, RG302, RG303	9527A13XX 9528A13XX	6.30 [.248]	2.40-4.60 [.094-.181]	1.40-4.30 [.055-.169]	0.30-2.80 [.011-.110]		Group 3

Part 2: Product Part Number Selection

One-Piece Coaxial Product Group	Preinstalled Wire Type	Preinstalled Wire Size					
		20 AWG	22 AWG	24 AWG	26 AWG	28 AWG	30 AWG
Group 1	Stranded (M22759)	—	B-044-22-N	B-044-24-N	B-044-26-N	—	—
	Solid (M81822)	—	—	B-043-24-N	B-043-26-N	B-043-28-N	B-043-30-N
Group 2	Stranded (M22759)	B-040-20-N	B-040-22-N	B-040-24-N	B-040-26-N	B-040-28-N	B-040-30-N
	Solid (M81822)	—	—	B-041-24-N	B-041-26-N	B-041-28-N	B-041-30-N
Group 3	Stranded (M22759)	B-020-20-N	B-020-22-N	B-020-24-N	B-020-26-N	—	—
	Solid (M81822)	—	—	—	B-021-26-N	—	—

- The B-02X/B-04X series uses a one-piece design to terminate coaxial cables rated at 125°C minimum.
- Using Part 1 of this table, select the appropriate coaxial product group (1, 2, or 3) based on your RG cable number, Raychem cable description, or cable dimensions.
- Using Part 2 of this table, select the product part number based on the coaxial product group you selected in Part 1 and the appropriate preinstalled lead type you selected on the previous page.

Table C. D-181 Series Part Numbers

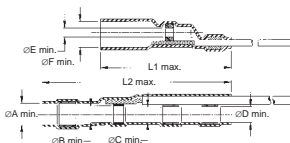

Product Name	Product Dimensions								Wire AWG
	A min.	B min.	C min.	D min.	E min.	F min.	L1 max.	L2 max.	
D-181-1220-90/9									20
D-181-1222-90/9									22
D-181-1224-90/9	3.7	3.2	2.7	2.4	2.3	0.71	17	21.5	24
D-181-1226-90/9	[0.145]	[0.125]	[0.105]	[0.095]	[0.09]	[0.028]	[0.67]	[0.85]	26
D-181-1826-6/9									26
D-181-1830-6/9									30
D-181-2220-90/9									20
D-181-2222-90/9									22
D-181-2224-90/9	4.5	4	3.45	2.9	3	1.1	17	22.7	24
D-181-2226-90/9	[0.18]	[0.16]	[0.135]	[0.115]	[0.12]	[0.045]	[0.67]	[0.895]	26
D-181-2826-6/9									26
D-181-2830-6/9									30
D-181-3220-90/9									20
D-181-3222-90/9									22
D-181-3224-90/9	5.2	4.7	4.45	3.95	4	1.3	17	21.5	24
D-181-3226-90/9	[0.205]	[0.185]	[0.175]	[0.155]	[0.16]	[0.055]	[0.67]	[0.85]	26
D-181-3826-6/9									26
D-181-3830-6/9									30

Table D. D-184 Series Part Numbers

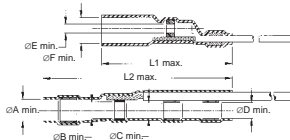

Product Name	Product Dimensions								Wire AWG
	∅A min.	∅B min.	∅C min.	∅D min.	∅E min.	∅F min.	L1 max.	L2 max.	
D-184-1220-90/9									20
D-184-1222-90/9									22
D-184-1224-90/9	3.7	3.2	2.7	2.4	2.3	0.71	17	21.5	24
D-184-1226-90/9	[0.145]	[0.125]	[0.105]	[0.095]	[0.09]	[0.028]	[0.67]	[0.85]	26
D-184-2220-90/9									20
D-184-2222-90/9									22
D-184-2224-90/9	4.5	4	3.45	2.9	3	1.1	17	22.7	24
D-184-2226-90/9	[0.18]	[0.16]	[0.135]	[0.115]	[0.12]	[0.045]	[0.67]	[0.895]	26

SolderSleeve PCB/Coaxial Cable Terminators

Product Facts

- Provides a completely shielded, low-resistance, matched-impedance termination with very low VSWR (D-607 series only)
- Transparent polyvinylidene fluoride insulation sleeve provides encapsulation, inspectability, strain relief, and insulation
- Prefluxed solder preform provides a controlled soldering process
- One-piece design offers easy installation and lower installed cost
- Preinstalled PCB termination body provides convenience and ease of installation



Applications

Used for terminating coaxial cable to printed circuit boards.

Installation

For proper installation of these devices, the correct heating tool and reflector attachment must be used. Any one of the following Raychem heating tools is recommended:

- HL1802E
- AA-400 Super Heater
- IR-1759 MiniRay
- CV-1981

Refer to Raychem installation procedure ES61139 for detailed instructions and recommended reflector attachments.

You will find ordering information for these tools in Section 10.

Product Selection Process

1. Select product series from the Product Options table below.
 2. Determine cable RG number or outside diameter dimensions.
 3. Select the appropriate part number from Table A (D-607 series) or Table B (B-046 series).
- For D-607 (matched impedance) series, determine straight or right-angle entry to PCB and grid pattern, then select the appropriate part number from Table A on the next page.
 - For B-046 (PinPak, or pin to ground) series, determine hole spacing and diameter. Refer to Table B for product selection (see illustration below for cable dimensions).

Available in:	
Americas	■
Europe	■
Asia Pacific	■

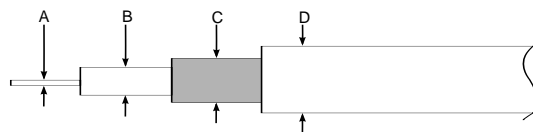

Product Options

Product Series	Typical Application Performance	Shield Method	Part No. Selection Table
D-607	Matched impedance up to 2.3 GHz	Metal body	A
B-046	Effective transmission up to 100 MHz	Pin to ground	B

Specifications/Approvals

Series	Raychem
D-607	RT-1404
B-046	RT-1404

Table A. D-607 Series Part Numbers

RG Cable No.	Cable Dimensions (mm/in) Max. Outside Diameter			Part No. Entry to PCB		
	Jacket	Shield	Dielectric	Straight grid 5.08 [.200]	Right-Angle Grid 5.08 [.200]	Straight Grid 2.54 [.100]
174, 178, 179, 316, 404	1.5–3.55 [.060–.140]	1.1–3.15 [.045–.125]	0.60–2.25 [.025–.090]	D-607-09	D-607-10	D-607-40*

Table B. B-046 Series Part Numbers

RG Cable No.	Cable Dimensions				Pin Diameter	Part No.		
	A	B	C	D Max.		Spacing Between Pins 2.54 [.100]	5.08 [.200]	6.35 [.250]
178, 404	0.30–0.80 [.011–.032]	0.5–1.7 [.019–.067]	1.3–2.3 [.050–.091]	3.4 [.134]	0.6 [.023]	B-046-14-N	B-046-10-N	B-046-12-N
					0.8 [.031]		B-046-11-N	B-046-13-N
179, 316	0.3–1.6 [.011–.063]	1.2–2.5 [.047–.100]	1.5–2.8 [.060–.110]	4.4 [.173]	0.6 [.023]	B-046-15-N	B-046-66-N	B-046-16-N
					0.8 [.031]		B-046-68-N	B-046-18-N

Product Characteristics

Material	
Insulation	Radiation-crosslinked, heat-shrinkable polyvinylidene fluoride
Solder and flux	Solder: Sn63 Pb37 Flux: ROL1 per ANSI - J - 004 (RMA flux)
Termination body/pin	Copper alloy, solder-plated
Typical Performance	
Voltage drop	2.0 mV
Tensile strength	Exceeds strength of conductor
Dielectric strength	2.0 kV
Temperature rating	-55°C to 150°C [-67°F to 302°F]
Insulation resistance	1000 megohms
Electrical Performance (typical) D-607 Series Only	
Frequency	VSWR (D-607-09, -40) VSWR (D-607-10)
350 MHz	1.04 max. 1.04 max.
700 MHz	1.05 max. 1.09 max.
2.3 GHz	1.09 max. 1.12 max.

RF One-Step BNC/TNC Connectors

Product Facts

- Easy, quick installation
- Outstanding cable-retention force
- Solder-solder connection type (center conductor and braid)
- One-step termination for easy, quick installation and lower installed cost
- Exceptional cable retention force to withstand high vibration and frequent mates and unmates
- Fully soldered center conductor and braid
- Excellent built-in strain relief against vibration and excessive handling
- Long-term reliability
- Controlled soldering termination
- Use with standard RG/U cables and Raychem Cheminax cables
- Three product sizes to accommodate a wide range of cables
- Meets performance requirements of MIL-C-39012 up to 2.8 GHz

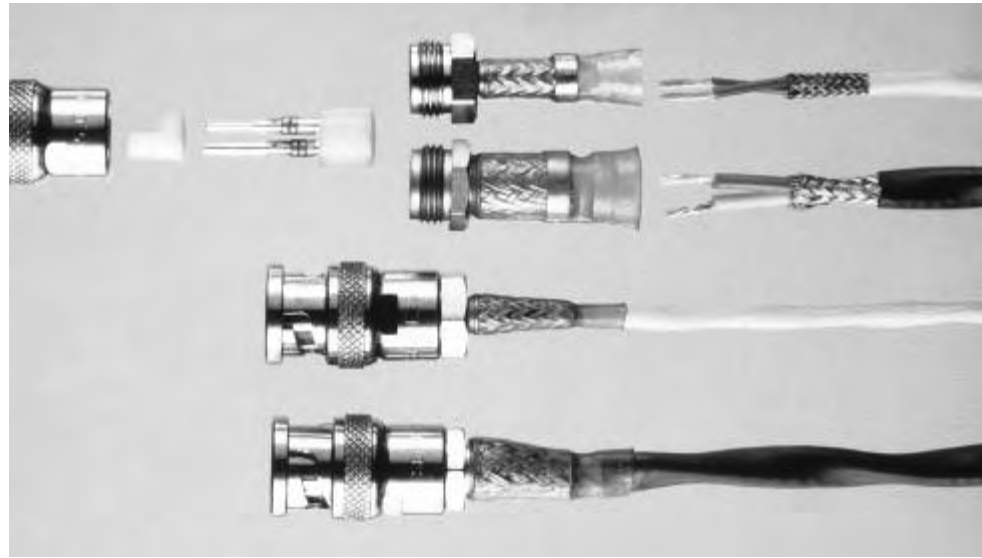

Applications

One-Step BNC/TNC connectors are single-piece assemblies for terminating the center conductor and the braid of a broad range of coaxial cables.

The connectors are fully intermateable with MIL-C-39012 connectors and are available in 50-ohm and 75-ohm versions.

Specifications	Installation
Raychem RB-115	<p>For proper installation of these devices, the correct heating tool and reflector attachment must be used.</p> <p>Any one of the following Raychem heating tools is recommended:</p> <ul style="list-style-type: none"> • Steinel® Model HL1802E • CV-1981

Refer to Raychem installation procedure RPIP 683-00 for detailed instructions.

Available in:	
Americas	■
Europe	■
Asia Pacific	■

Product Options and Part Numbering System

RXX - XX - X - XX	Connector Style		Connector Type		
	Dash No. -XX	Style	TNC	BNC	
	-00	Straight plug			
	-01	Right-angle plug			
	-02	Straight bulkhead jack			
	-03	Straight jack			
	-04	Straight panel jack			
	Connector size		4 x M2.5 x 0.45		
	L = Large				
	M = Medium				
	S = Small				
	50 = 50 ohms				
	75 = 75 ohms				
	D = Nickel-plated brass body, gold-plated brass pin				
	B = BNC				
	T = TNC				

Example: RBD-50-L-00 is a BNC connector, 50 ohms, large size, with straight plug body.

Product Characteristics

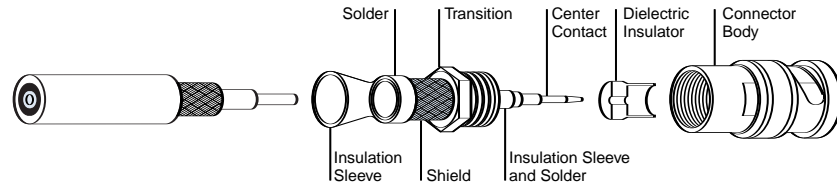

Material	
Center contact	Gold-plated beryllium copper (female)
	Gold-plated brass (male)
Dielectric insulator	PTFE
Transition	Silver-plated brass
Connector body	Nickel-plated brass
Solder and flux	Sn63Pb37, RMA flux
Braided shield	Tin-plated copper wire per ASTM B3
Insulation sleeve	Radiation-crosslinked, heat-shrinkable polyvinylidene fluoride, transparent blue
Strain relief/sealing sleeve	Radiation-crosslinked, heat-shrinkable modified polyolefin with adhesive, black
Typical Performance	
Dielectric withstand voltage	1500 V
Insulation resistance	5000 megohms
Temperature rating	-55°C to 150°C [-67°F to 302°F]
Contact resistance-straight	Inner = 1.5 milliohms, outer = 1.0 milliohm
Contact resistance — right-angle	Inner = 2.5 milliohms, outer = 1.5 milliohms
Cable retention force	295N (66 lb) to 822N (196 lb)
Voltage rating	500 V RMS
Connector durability	500 mating cycles minimum
Electrical Performance	
Nominal impedance	50 and 75 ohms
Frequency range	Up to 2.8 GHz

Part Selection Process

1. From Product Options and Part Numbering System on page 8-56, select the connector style you need (BNC or TNC, plug or jack, male or female contacts).
2. From the tables that follow, find the appropriate table for the connector style you selected.
3. From the appropriate table, select the connector part number based on the RG cable type or Raychem cable part number. For cable types not shown use the cable dimensions.
Note: The cable dimensions in each table are keyed to the diagram below.

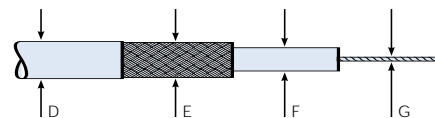

Impedance (ohms)	Cable Type		Cable Dimensions				Part No.
	RG Cables	Raychem Cables	D (Min.-Max.)	E (Min.-Max.)	F (Max.)	G (Max.)	
BNC Straight Plugs, Male Contacts							
50	RG-174, RG-178, RG-188, RG-196, RG-316	5026A1311, 5028A1317, 5030A1317	1.50-5.50 [.060-.217]	0.90-3.00 [.035-.118]	1.55 [.060]	0.65 [.025]	RBD-50-S-00
50	RG-58, RG-141, RG-142, RG-303, RG-400	5019D3318, 5021D1331, 5020A1311	3.50-7.00 [.138-.276]	2.10-5.00 [.083-.197]	3.00 [.118]	1.25 [.050]	RBD-50-M-00
50	RG-165, RG-215, RG-213, RG-225, RG-214	5012F3332, 5012A3311	5.00-12.50 [.197-.500]	4.10-9.50 [.161-.375]	7.30 [.287]	2.45 [.100]	RBD-50-L-00
75	RG-179, RG-187	7530A1317	1.50-5.00 [.060-.217]	5 0.90-3.00 [.035-.118]	1.55 [.060]	0.65 [.025]	RBD-75-S-00
75	—	7524A1311, 7528A1317	3.50-7.00 [.138-.276]	2.10-5.00 [.083-.197]	3.70 [.126]	1.25 [.050]	RBD-75-M-00
75	RG-6, RG-11, RG-12, RG-59 RG-144, RG-216	—	5.00-12.50 [.197-.500]	4.10-9.50 [.161-.375]	7.3 [.287]	2.45 [.100]	RBD-75-L-00
BNC Right-Angle Plugs, Male Contacts							
50	RG-174, RG-178, RG-188, RG-196, RG-316	5026A1311, 5028A1317, 5030A1317	1.50-5.50 [.060-.217]	0.90-3.00 [.035-.118]	1.55 [.060]	0.65 [.025]	RBD-50-S-01
50	RG-58, RG-141, RG-142, RG-303, RG-400	5019D3318, 5021D1331, 5020A1311	3.50-7.00 [.138-.276]	2.10-5.00 [.083-.197]	3.00 [.118]	1.25 [.050]	RBD-50-M-01
50	RG-165, RG-215, RG-213, RG-225, RG-214	5012F3332, 5012A3311	5.00-12.50 [.197-.500]	4.1-9.50 [.161-.375]	7.30 [.287]	2.45 [.100]	RBD-50-L-01
75	RG-179, RG-187	7530A1317	1.50-5.50 [.060-.217]	0.9-3.00 [.035-.118]	1.55 [.060]	0.65 [.025]	RBD-75-S-01
75	—	524A1311, 7528A1317	3.50-7.00 [.138-.276]	2.1-5.00 [.083-.197]	3.70 [.146]	1.25 [.050]	RBD-75-M-01
75	RG-6, RG-11, RG-12, RG-59 RG-144, RG-216	—	5.00-12.50 [.197-.500]	4.1-9.50 [.161-.375]	7.30 [.287]	2.45 [.100]	RBD-75-L-01
BNC Straight Bulkhead Jacks, Female Contacts							
50	RG-174, RG-178, RG-188, RG-196, RG-316	5026A1311, 5028A1317, 5030A1317	1.50-5.50 [.060-.217]	0.90-3.00 [.035-.118]	1.55 [.060]	0.65 [.025]	RBD-50-S-02
50	RG-58, RG-141, RG-142, RG-303, RG-400	5019D3318, 5021D1331, 5020A1311	3.50-7.00 [.138-.276]	2.10-5.00 [.083-.197]	3.00 [.118]	1.25 [.050]	RBD-50-M-02
50	RG-165, RG-215, RG-213, RG-225, RG-214	5012F3332, 5012A3311	5.00-12.50 [.197-.500]	4.10-9.50 [.161-.375]	7.30 [.287]	2.45 [.100]	RBD-50-L-02
75	RG-179, RG-187	7530A1317	1.50-5.00 [.060-.217]	5 0.90-3.00 [.035-.118]	1.55 [.060]	0.65 [.025]	RBD-75-S-02
75	—	75 7524A1311, 7528A1317	3.50-7.00 [.138-.276]	2.10-5.00 [.083-.197]	3.70 [.146]	1.25 [.050]	RBD-75-M-02
75	RG-6, RG-11, RG-12, RG-59 RG-144, RG-216	—	5.00-12.50 [.197-.500]	4.10-9.50 [.161-.375]	7.30 [.287]	2.45 [.100]	RBD-75-L-02
BNC Straight Jacks, Female Contacts							
50	RG-174, RG-178, RG-188, RG-196, RG-316	5026A1311, 5028A1317, 5030A1317	1.50-5.50 [.060-.217]	0.90-3.00 [.035-.118]	1.55 [.060]	0.65 [.025]	RBD-50-S-03
50	RG-58, RG-141, RG-142, RG-303, RG-400	5019D3318, 5021D1331, 5020A1311	3.50-7.00 [.138-.276]	2.10-5.00 [.083-.197]	3.00 [.118]	1.25 [.050]	RBD-50-M-03
50	RG-165, RG-215, RG-213, RG-225, RG-214	5012F3332, 5012A3311	5.00-12.50 [.197-.500]	4.10-9.50 [.161-.375]	7.30 [.287]	2.45 [.100]	RBD-50-L-03
75	RG-179, RG-187	7530A1317	1.50-5.50 [.060-.217]	0.90-3.00 [.035-.118]	1.55 [.060]	0.65 [.025]	RBD-75-S-03
75	—	75 7524A1311, 7528A1317	3.50-7.00 [.138-.276]	2.10-5.00 [.083-.197]	3.70 [.146]	1.25 [.050]	RBD-75-M-03
75	RG-6, RG-11, RG-12, RG-59 RG-144, RG-216	—	5.00-12.50 [.197-.500]	4.10-9.50 [.161-.375]	7.30 [.287]	2.45 [.100]	RBD-75-L-03
BNC Straight Panel Jacks, Female Contacts							
50	RG-174, RG-178, RG-188, RG-196, RG-316	5026A1311, 5028A1317, 5030A1317	1.50-5.50 [.060-.217]	0.90-3.00 [.035-.118]	1.55 [.060]	0.65 [.025]	RBD-50-S-04
50	RG-58, RG-141, RG-142, RG-303, RG-400	5019D3318, 5021D1331, 5020A1311	3.50-7.00 [.138-.276]	2.10-5.00 [.083-.197]	3.00 [.118]	1.25 [.050]	RBD-50-M-04
50	RG-165, RG-215, RG-213, RG-225, RG-214	5012F3332, 5012A3311	5.00-12.50 [.197-.500]	4.10-9.50 [.161-.375]	7.30 [.287]	2.45 [.100]	RBD-50-L-04
75	RG-179, RG-187	7530A1317	1.50-5.50 [.060-.217]	0.90-3.00 [.035-.118]	1.55 [.060]	0.65 [.025]	RBD-75-S-04
75	—	7524A1311, 7528A1317	3.50-7.00 [.138-.276]	2.10-5.00 [.083-.197]	3.70 [.146]	1.25 [.050]	RBD-75-M-04
75	RG-6, RG-11, RG-12, RG-59 RG-144, RG-216	—	5.00-12.50 [.197-.500]	4.10-9.50 [.161-.375]	7.30 [.287]	2.45 [.100]	RBD-75-L-04

TNC Coaxial Connectors

Impedance (ohms)	Cable Type		Cable Dimensions				Part No.
	RG Cables	Raychem Cables	D (Min.-Max.)	E (Min.-Max.)	F (Max.)	G (Max.)	
TNC Straight Plugs, Male Contacts							
50	RG-174, RG-178, RG-188, RG-196, RG-316	5026A1311, 5028A1317, 5030A1317	1.50-5.50 [.060-.217]	0.90-3.00 [.035-.118]	1.55 [.060]	0.65 [.025]	RTD-50-S-00
50	RG-58, RG-141, RG-142, RG-303, RG-400	5019D3318, 5021D1331, 5020A1311	3.50-7.00 [.138-.276]	2.10-5.00 [.083-.197]	3.00 [.118]	1.25 [.050]	RTD-50-M-00
50	RG-165, RG-215, RG-213, RG-225, RG-214	5012F3332, 5012A3311	5.00-12.50 [.197-.500]	4.10-9.50 [.161-.375]	7.30 [.287]	2.45 [.100]	RTD-50-L-00
75	RG-179, RG-187	7530A1317	1.50-5.50 [.060-.217]	0.90-3.00 [.035-.118]	1.55 [.060]	0.65 [.025]	RTD-75-S-00
75	—	7524A1311, 7528A1317	3.50-7.00 [.138-.276]	2.10-5.00 [.083-.197]	3.70 [.146]	1.25 [.050]	RTD-75-M-00
75	RG-6, RG-11, RG-12, RG-59 RG-144, RG-216	—	5.00-12.50 [.197-.500]	4.10-9.50 [.161-.375]	7.30 [.287]	2.45 [.100]	RTD-75-L-00
TNC Straight Jacks, Female Contacts							
50	RG-174, RG-178, RG-188, RG-196, RG-316	5026A1311, 5028A1317, 5030A1317	1.5-5.5 [.060-.217]	0.9-3.0 [.035-.118]	1.55 [.060]	0.65 [.025]	RTD-50-S-03
50	RG-58, RG-141, RG-142, RG-303, RG-400	5019D3318, 5021D1331, 5020A1311	3.5-7.0 [.138-.276]	2.1-5.0 [.083-.197]	3.0 [.118]	1.25 [.050]	RTD-50-M-03
50	RG-165, RG-215, RG-213, RG-225, RG-214	5012F3332, 5012A3311	5.0-12.5 [.197-.500]	4.1-9.5 [.161-.375]	7.3 [.287]	2.45 [.100]	RTD-50-L-03
75	RG-179, RG-187	7530A1317	1.5-5.5 [.060-.217]	0.9-3.0 [.035-.118]	1.55 [.060]	0.65 [.025]	RTD-75-S-03
75	—	7524A1311, 7528A1317	3.5-7.0 [.138-.276]	2.1-5.0 [.083-.197]	3.7 [.146]	1.25 [.050]	RTD-75-M-03
75	RG-6, RG-11, RG-12, RG-59 RG-144, RG-216	—	5.0-12.5 [.197-.500]	4.1-9.5 [.161-.375]	7.3 [.287]	2.45 [.100]	RTD-75-L-03
TNC Straight Panel Jacks, Female Contacts							
50	RG-174, RG-178, RG-188, RG-196, RG-316	5026A1311, 5028A1317, 5030A1317	1.5-5.5 [.060-.217]	0.9-3.0 [.035-.118]	1.55 [.060]	0.65 [.025]	RTD-50-S-04
50	RG-58, RG-141, RG-142, RG-303, RG-400	5019D3318, 5021D1331, 5020A1311	3.5-7.0 [.138-.276]	2.1-5.0 [.083-.197]	3.0 [.118]	1.25 [.050]	RTD-50-M-04
50	RG-165, RG-215, RG-213, RG-225, RG-214	5012F3332, 5012A3311	5.0-12.5 [.197-.500]	4.1-9.5 [.161-.375]	7.3 [.287]	2.45 [.100]	RTD-50-L-04
75	RG-179, RG-187	7530A1317	1.5-5.5 [.060-.217]	0.9-3.0 [.035-.118]	1.55 [.060]	0.65 [.025]	RTD-75-S-04
75	—	7524A1311, 7528A1317	3.5-7.0 [.138-.276]	2.1-5.0 [.083-.197]	3.7 [.146]	1.25 [.050]	RTD-75-M-04
75	RG-6, RG-11, RG-12, RG-59 RG-144, RG-216	—	5.0-12.5 [.197-.500]	4.1-9.5 [.161-.375]	7.3 [.287]	2.45 [.100]	RTD-75-L-04

TNC Coaxial Connectors

Panel thickness: 3.2 [.125] max.

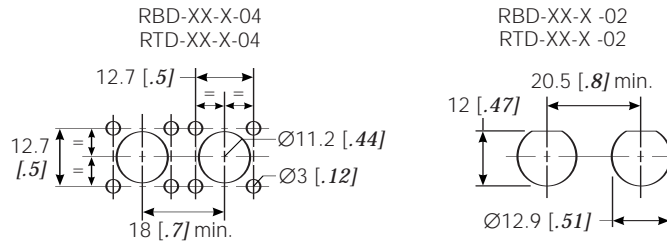

Impedance (ohms)	Cable Type		Cable Dimensions				Part No.
	RG Cables	Raychem Cables	D (Min.-Max.)	E (Min.-Max.)	F (Max.)	G (Max.)	
TNC Straight Bulkhead Jacks, Female Contacts							
50	RG-174, RG-178, RG-188, RG-196, RG-316	5026A1311, 5028A1317, 5030A1317	1.50-5.50 [.060-.217]	0.90-3.00 [.035-.118]	1.55 [.060]	0.65 [.025]	RTD-50-S-02
50	RG-58, RG-141, RG-142, RG-303, RG-400	5019D3318, 5021D1331, 5020A1311	3.5-7.0 [.138-.276]	2.10-5.00 [.083-.197]	3.00 [.118]	1.25 [.050]	RTD-50-M-02
50	RG-165, RG-215, RG-213, RG-225, RG-214	5012F3332, 5012A3311	5.0-12.5 [.197-.500]	4.10-9.50 [.161-.375]	7.30 [.287]	2.45 [.100]	RTD-50-L-02
75	RG-179, RG-187	7530A1317	1.5-5.5 [.060-.217]	0.90-3.00 [.035-.118]	1.55 [.060]	0.65 [.025]	RTD-75-S-02
75	—	7524A1311, 7528A1317	3.5-7.0 [.138-.276]	2.10-5.00 [.083-.197]	3.70 [.146]	1.25 [.050]	RTD-75-M-02
75	RG-6, RG-11, RG-12, RG-59, RG-144, RG-216	—	5.0-12.5 [.197-.500]	4.10-9.50 [.161-.375]	7.30 [.287]	2.45 [.100]	RTD-75-L-02
TNC Right-Angle Plugs, Male Contacts							
50	RG-174, RG-178, RG-188, RG-196, RG-316	5026A1311, 5028A1317, 5030A1317	1.50-5.50 [.060-.217]	0.90-3.00 [.035-.118]	1.55 [.060]	0.65 [.025]	RTD-50-S-01
50	RG-58, RG-141, RG-142, RG-303, RG-400	5019D3318, 5021D1331, 5020A1311	3.50-7.00 [.138-.276]	2.10-5.00 [.083-.197]	3.00 [.118]	1.25 [.050]	RTD-50-M-01
50	RG-165, RG-215, RG-213, RG-225, RG-214	5012F3332, 5012A3311	5.00-12.50 [.197-.500]	4.10-9.50 [.161-.375]	7.30 [.287]	2.45 [.100]	RTD-50-L-01
75	RG-179, RG-187	7530A1317	1.50-5.50 [.060-.217]	0.90-3.00 [.035-.118]	1.55 [.060]	0.65 [.025]	RTD-75-S-01
75	—	7524A1311, 7528A1317	3.50-7.00 [.138-.276]	2.10-5.00 [.083-.197]	3.70 [.146]	1.25 [.050]	RTD-75-M-01
75	RG-6, RG-11, RG-12, RG-59, RG-144, RG-216	—	5.0-12.5 [.197-.500]	4.10-9.50 [.161-.375]	7.30 [.287]	2.45 [.100]	RTD-75-L-01

**Introduction**

The question is, how to meet growing performance requirements for shielded cable system fabrication and maintenance while minimizing electromagnetic interference (EMI). The answer is Raychem SolderShield cable splices. SolderShield devices are one-piece products consisting of a flux-coated, solder-impregnated copper shield braid encased in a heat-shrinkable insulation sleeve.

SolderShield cable-to-cable splice kits, designed for single-conductor or multi-conductor shielded cables, are ideal for fabrication/repair/rework while restoring the electrical integrity of the cable.

SolderShield devices perform even in demanding environments. They are reliable, versatile, and easy to install.

SolderShield Shielded and Coaxial Cable Splices

Product Facts

- Flux-coated, solder-impregnated copper shield braid encased in a transparent heat-shrinkable insulation sleeve provides a controlled soldering process, encapsulation, inspectability, strain relief, and insulation
- One-piece design provides easy installation and lower installed cost
- Circumferential (360°) shielding results in EMI protection and shield continuity equal to or better than the original cable
- Conductor splices are made using Raychem MiniSeal crimp products, which are recognized by MIL-S-81824 and MIL-W-5088

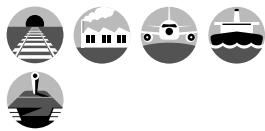

Applications

Used for splicing a wide range of cables, including coaxial and multiconductor cables.

SolderShield devices can be used to repair or splice shielded or coaxial cables. These products consist of a MiniSeal crimp splice plus a flux-coated, solder-impregnated copper shield encased in a heat-shrinkable sealing sleeve, for splicing the shields. SolderShield kits terminate single- or multiple-conductor cables, eliminate EMI problems at the splice, and provide strain relief for the cable.

Product Selection Process

For splicing multiconductor cables refer to Table A.

For splicing coaxial cables refer to Table B.

Installation

For proper installation of these devices, the correct heating tool and reflector attachment must be used. Any one of the following Raychem heating tools is recommended:

- HL1802E
- IR-1759 MiniRay
- CV-1981

Refer to Raychem installation procedure RCPS 150-02 (D-150 series) and RPIP 699-00 (B-202 series) for detailed instructions and recommended reflector attachment.

You will find ordering information for most of these tools in Section 10.

Specifications/Approvals

Series	Military	Raychem
D-150	US: M81824 (conductor splice only) UK: RAF AP 1130-2008-1	RT-1404

Available in:

- Americas ■
- Europe ■
- Asia Pacific ■

SolderShield Shielded and Coaxial Cable Splices (Continued)

Table A. Multiconductor Cable Splices

Each SolderShield part consists of a SolderShield splice and one or more conductor splices. Refer to information below for description and numbers of conductor splices.

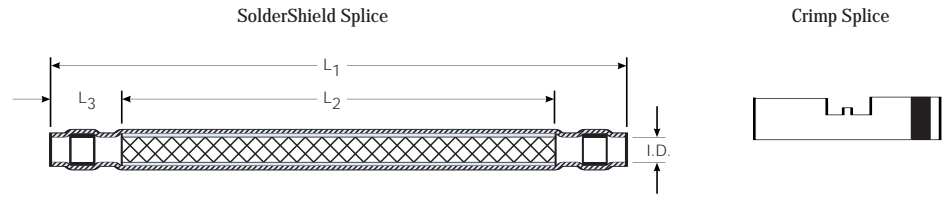

SolderShield Product Dimensions

Part No.		Dimensions				Conductor Splice	Color Code	Quantity Per Kit
Tin Plated	Nickel Plated	L1 Max.	L2 Nom.	L3 Min.	ID Min.	Size Range CMA [mm ²] Min.-Max.		
D-150-0168	D-150-0228	80.50 [3.17]	50.00 [1.97]	10.20 [.400]	3.00 [.118]	304-1510 [0.15-0.75]	Red	1
D-150-0169	D-150-0229	80.50 [3.17]	50.00 [1.97]	10.20 [.400]	4.00 [.157]	779-2680 [0.39-1.34]	Blue	1
D-150-0170	D-150-0230	80.50 [3.17]	50.00 [1.97]	10.20 [.400]	5.00 [.197]	1900-6755 [0.95-3.37]	Yellow	1
D-150-0174	D-150-0231	10.60 [4.17]	75.00 [2.95]	10.20 [.400]	4.00 [.157]	304-1510 [0.15-0.75]	Red	2
D-150-0175	D-150-0232	10.60 [4.17]	75.00 [2.95]	10.20 [.400]	5.00 [.197]	779-2680 [0.39-1.34]	Blue	2
D-150-0176	D-150-0233	10.60 [4.17]	75.00 [2.95]	10.20 [.400]	6.00 [.236]	1900-6755 [0.95-3.37]	Yellow	2
D-150-0177	D-150-0234	10.60 [4.17]	75.00 [2.95]	10.20 [.400]	9.00 [.356]	304-1510 [0.15-0.75]	Yellow	2
D-150-0178	D-150-0235	10.60 [4.17]	75.00 [2.95]	10.20 [.400]	4.00 [.157]	304-1510 [0.15-0.75]	Red	4
D-150-0179	D-150-0236	10.60 [4.17]	75.00 [2.95]	10.20 [.400]	5.00 [.197]	779-2680 [0.39-1.34]	Red	4
D-150-0180	D-150-0237	10.60 [4.17]	75.00 [2.95]	10.20 [.400]	6.00 [.236]	1900-6755 [0.95-3.37]	Blue	4
D-150-0181	D-150-0238	10.60 [4.17]	75.00 [2.95]	10.20 [.400]	9.00 [.353]	1900-6755 [0.95-3.37]	Yellow	4

Note: The SolderShield splice kits listed in this table are for 1:1 cable splices. The kits can be used on cables with tin-, silver-, and nickel-plated copper conductors. All the kits have environmental-sealing capability. The cable temperature rating must be 125°C minimum.

To find the splice kit part number for your application:

1. Determine the number of conductors in the cable to be spliced.
2. Determine the gauge of each conductor or the maximum jacket OD.
3. Determine the conductor plating.
4. Select the appropriate part number from the table above.

SolderShield Shielded and Coaxial Cable Splices (Continued)

Table B. Coaxial Cable Splices

Each SolderShield part consists of a SolderShield splice and one or more conductor splices. Refer to information below for description and numbers of conductor splices.

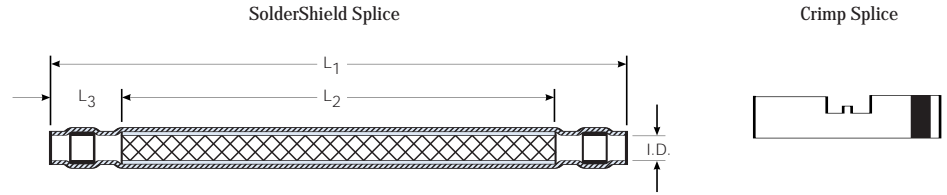

RG Cable No.	Raychem Cable Description	Conductor Splice Qty/Kit	Part No.	SolderShield Dimensions		
				L1 Max	L2 Min	ID Min
8A, 9B, 11	5012A3311					
13, 26, 31	5012E1339					
115, 144, 149	7518A1311	1	D-150-0214	80.50 [3.170]	50.00 [1.970]	12.00 [.472]
165, 213, 214	—					
216, 235, 391	—					
393, 397	—					
178, 196,	5028A1317					
179, 187, 188,	7528A1317	1	D-150-0094	80.50 [3.170]	50.00 [1.970]	3.00 [.118]
316, 404, M17/138-00001,	5030A1317					
M17/136-00001	7530A1317					
180, 195	5024A1311					
M17/137-00001	7526A1311	1	D-150-0095	80.50 [3.170]	50.00 [1.970]	4.00 [.157]
M17/139-00001	9527A1318					
—	9530E1014					
124, 140, 141	5020A1311					
159, 302, 303	5022A1311	1	D-150-0096	80.50 [3.170]	50.00 [1.970]	5.00 [.236]
—	7522A1311					
—	7523D1331					
—	7524A1311					
29, 30, 55B	5019D3318	1	B-202-81*	56.00 [2.200]	23.00 [.900]	7.00 [.275]
58, 223	5021D1331					
—	5022A1311					
59, 62, 71	7523D1331	1	B-202-82*	56.00 [2.200]	23.00 [.900]	7.00 [.275]
—	7524A1311					
—	9524A1311					

*These kits use solder to terminate the center conductors. All other kits use crimp.

All kits are for one-to-one coaxial cable splices, and all kits have environmental sealing capability. Each kit contains products to splice conductors, build up dielectric, splice the shield, and provide insulation.

Product Characteristics

Materials		
Insulation sleeve	Radiation-crosslinked polyvinylidene fluoride	
Melttable inserts	Fluorocarbon-based thermoplastic	
MiniSeal crimp splice	Base metal: Copper alloy C10200 per ASTM B75 Plating: Tin per MIL-T-10727 or nickel per QQ-N-290	
SolderShield shield splice	Base metal: Tin-plated copper wire braid per ASTM B3 Solder and flux coating: Type Sn63 Pb37. Flux: ROM1 per ANSI - J - STD - 004 (RA flux)	
Parameter	Test Method	Requirement
Electromechanical Performance		
Dielectric strength (shield connection)	—	No breakdown or arcing at 1000 Vac (RMS)
Dielectric strength (conductor connection)	—	2.5 kV
Voltage drop	MIL-S-81824	Less than 2.0-millivolt increase
Insulation resistance (shield connection)	—	1000 megohms minimum at 500 Vdc
Insulation resistance (conductor connection)	—	5000 megohms
Tensile strength for MiniSeal	MIL-S-81824	Exceed yield strength (pounds) of wire.
Tensile strength for SolderShield	MIL-S-81824	75% of strength (pounds) of unspliced cable
Temperature rating	—	-55°C to 150°C [-67°F to 302°F]
Environmental Resistance		
Salt spray	MIL-STD-202 M101	Meet voltage drop requirement.
Heat aging	750 hours at 150°C [302°F]	Meet all electromechanical requirements.
Temperature cycling	MIL-STD-202 M107C	Meet all electromechanical requirements.
Altitude immersion	Immersion at 22,860m [75,000 ft]	Meet insulation-resistance requirement.
Corrosion resistance	—	No evidence of corrosion after testing in accordance with MIL-STD-202, Method 101, Test Condition A



**Introduction**

Raychem SolderTacts shielded contacts are designed to provide reliable, one-piece solder terminations for use with circular and rectangular connectors. These controlled soldering contacts help speed installation and reduce installed costs while eliminating the variables associated with hard-to-handle crimped terminations.

With Tyco Electronics' controlled soldering technology, the connections typically exceed the strength of the wire. Transparent insulation and inspection windows permit fully inspectable terminations.

SolderTacts products are available to terminate coaxial cable and twisted wire pairs in both military and commercial applications.

Product Facts

- Reliable one-piece solder contacts: through-connector shielding reduces cross-talk, and improves signal transmission
- One-step installation
- Solder joints are strong and reliable
- Terminations are fully inspectable
- Termination for coax cables, shielded wires, twisted pairs, triaxial cables, for a variety of commercial and military connectors

SolderTacts Shielded One-Piece Solder Contacts



Applications

One-piece controlled-soldering SolderTacts contacts are designed to terminate coaxial cables, shielded wires, and twisted pairs faster and more reliably than any other method. SolderTacts contacts eliminate the variables associated with hard-to-handle crimping. Their one-step installation accelerates production while reducing handling and installed costs.

Controlled Soldering

SolderTacts contacts provide the optimum amount and type of solder and flux in prefluxed solder preforms to control soldering and reduce operator sensitivity. The geometry of the coaxial

cable is carried through the connector to eliminate separate pins, help reduce cross talk, and improve shielding effectiveness and signal transmission.

SolderTacts contacts provide simultaneous electrical connection and strain relief. Heat-shrinkable tubing insulations eliminate stress concentration on the wire within the contact. Because the insulation is transparent and inspection windows are provided, terminations are fully inspectable.

Compatibility

The design versatility of SolderTacts contacts makes them exceptionally well suited to military applications, along with commercial

aerospace, instrumentation and computers. SolderTacts products are compatible with most standard connector cavities. SolderTacts contacts are intermateable and intermountable with contacts qualified to the indicated specification.

SolderTacts shielded contacts can be terminated with standard Raychem heating tools. Once terminated, they can be installed into connector cavities with standard insertion and extraction tools. They are replaceable without cutting and restripping or shortening the cable.

Specifications/Approvals

Available in:	
Americas	■
Europe	■
Asia Pacific	■

Series	Raychem
D-602	D-6002

SolderTacts Shielded One-Piece Solder Contacts (Continued)

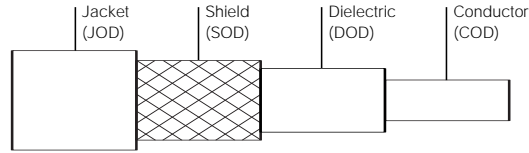
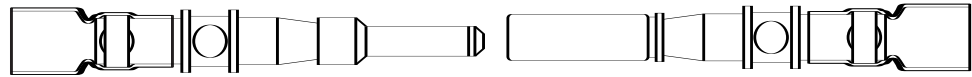

SolderTacts Product Construction, MIL-C-26482 Series

SolderTacts Series:
MIL-C-26482

Contact Military Specification	Cable Diameter				Wire (AWG)	Raychem SolderTacts Part No.	Size	Polarity	Cable Type
	JOD	SOD	DOD	COD					
MIS-20067/5-001†	1.78-4.70 [.070-.185]	1.65-2.79 [.065-.110]	.76-2.03 [.030-.080]	.23-.51 [.009-.020]	24-32	D-602-16	12	S	Coaxial
MIS-20067/6-001†	1.78-4.70 [.070-.185]	1.65-2.79 [.065-.110]	.76-2.03 [.030-.080]	.23-.51 [.009-.020]	24-32	D-602-17	12	P	Coaxial
—	1.52-3.30 [.060-.130]	1.68-2.13 [.066-.089]	.91-1.75 [.036-.069]	.30-.66 [.012-.026]	24-30	D-602-46	16	P	Coaxial
—	1.52-3.30 [.060-.130]	1.68-2.13 [.066-.089]	.91-1.75 [.036-.069]	.30-.66 [.012-.026]	26-32	D-602-47	16	S	Coaxial
—	—	—	.76-1.24 [.030-.049]	.28-.79 [.011-.031]	24-30	D-602-56	16	P	Twinax
—	—	—	.76-1.24 [.030-.049]	.28-.79 [.011-.031]	24-30	D-602-57	16	S	Twinax

†These SolderTacts contacts are on qualified parts list for indicated specification.

Tooling Selection Guide

Part Numbers	Engineering Standard (Termination Instructions)	Convection (Hot Air) Heating (AT-1319 Adapter)	Repair Wand	Contact Insertion Tool	Contact Removal Tool
D-602-46/47	ES61137	AT-1319-17	*	AD-1525	AD-1526
D-602-56/57	ES61138	—	—	(M81969/17-04)	(M81969/19-08)
D-602-16/17	ES61161	—	—	—	—

*Could be developed.

Note:

AA-400 SuperHeater Compressed Air Heating Tool shown on page 10-2 can be used for installation. Another option is the Steinel® General Purpose Hot-Air Heating Tool shown on page 10-13.

SolderTacts Shielded One-Piece Solder Contacts (Continued)

SolderTacts Series:
MIL-C-28748 Series

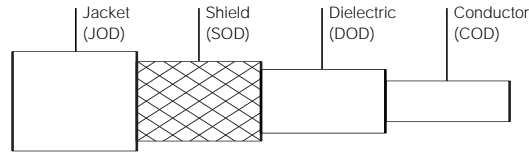

SolderTacts product construction, MIL-C-28748 Series

Contact Military Specification	Cable Diameter				Raychem Wire (AWG)	SolderTacts Part No.	Size	Polarity	Cable Type
	JOD	SOD	DOD	COD					
MIS-20067/2-002 ^a	1.52-3.35 [.060-.132]	1.68-2.13 [.066-.084]	.91-1.78 [.036-.070]	.23-.89 [.009-.035]	26-32	D-602-44	16	P	Coaxial
MIS-20067/1-001 ^a	1.52-3.35 [.060-.132]	1.68-2.13 [.066-.084]	.91-1.78 [.036-.070]	.23-.89 [.009-.035]	26-32	D-602-45	16	S	Coaxial
MIS-20067/4-001 ^a	—	—	.76-1.24 [.030-.049]	.28-.79 [.011-.031]	24-30	D-602-54	16	P	Twisted pair
MIS-20067/3-001 ^a	—	—	.76-1.24 [.030-.049]	.28-.79 [.011-.031]	24-30	D-602-55	16	S	Twisted pair
M39029/79 ^b	1.52-3.35 [.060-.132]	1.68-2.13 [.066-.084]	.91-1.68 [.036-.066]	.30-.66 [.012-.026]	26-32	D-602-72	16	P	Coaxial
M39029/80 ^b	1.52-3.35 [.060-.132]	1.68-2.13 [.066-.084]	.91-1.68 [.036-.066]	.30-.66 [.012-.026]	26-32	D-602-73	16	S	Coaxial
M39029/40 ^b	1.52-3.35 [.060-.132]	1.68-2.13 [.066-.084]	.91-1.68 [.036-.066]	.30-.66 [.012-.026]	26-32	D-602-76	16	P	Coaxial
M39029/41 ^b	1.52-3.35 [.060-.132]	1.68-2.13 [.066-.084]	.91-1.68 [.036-.066]	.30-.66 [.012-.026]	26-32	D-602-77	16	S	Coaxial
—	—	—	.76-1.24 [.030-.049]	.28-.79 [.011-.031]	24-30	D-602-0126	16	P	Twisted pair ^c
—	—	—	.76-1.24 [.030-.049]	.28-.79 [.011-.031]	24-30	D-602-0127	16	S	Twisted pair ^c
—	1.52-3.35 [.060-.132]	1.68-2.13 [.066-.084]	.91-1.78 [.036-.070]	.23-.46 [.009-.018]	28-32	D-602-0172	16	P	Coaxial
MIS-20067/2-001, 003 ^a	1.52-3.35 [.060-.132]	1.68-2.13 [.066-.084]	.91-1.78 [.036-.070]	.23-.46 [.009-.018]	28-32	D-602-0173	16	S	Coaxial
MIS-20067/8-001 ^a	—	—	1.40-3.15 [.055-.124]	.64-1.57 [.025-.062]	16-20	D-610-09	16	P	Power
MIS-20067/7-001 ^a	—	—	1.40-3.15 [.055-.124]	.64-1.57 [.025-.062]	16-20	D-610-10	16	S	Power

a These SolderTacts contacts are on the qualified parts list for indicated specification.

b These SolderTacts contacts are intermateable and intermountable with contacts qualified to the indicated specification; they replace crimp-style termination.

c These SolderTacts contacts are designed for twisted-pair cable per MIL-STD-1553B.

Tooling Selection Guide:
MIL-C-28748 Series

SolderTacts Series	Part No.	Engineering Standard (Termination Instructions)	Convection (Hot Air) Heating	
			AT-1319 Adapter	Repair Wand
748	D-602-44/45	ES61133	AT-1319-14	AD-1480
	D-602-0172/0173	ES61240	—	—
	D-602-54/55	ES61132	—	—
	D-602-0126/0127	ES61199	—	—
	D-610-09/10	ES61187	AT-1319-15	AD-1571
	D-602-72/73	ES61135	AT-1319-18	AD-1486
	D-602-76/77	ES61164	AT-1319-20	AD-1554
SolderTacts Series	Contact Insertion Tool	Contact Removal Tool	Special Tools	
748	*	AD-1447	AD-1457A (bushing tool)	AD-1464 (flex tip removal tool)

*Not applicable.

Note:
AA-400 SuperHeater Compressed Air Heating Tool shown on page 10-2 can be used for installation. Another option is the Steinel® General Purpose Hot-Air Heating Tool shown on page 10-13.

SolderTacts Shielded One-Piece Solder Contacts (Continued)

SolderTacts Series:
MIL-C-38999, Series I, II,
III, IV Circular Connectors

SolderTacts Product Construction, MIL-C-38999 Series

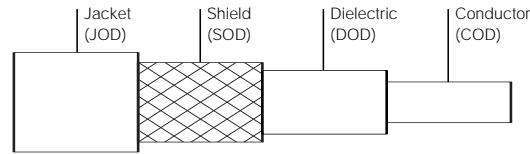

Contact Military Specification	United States Air Force Drawing No.	Cable Diameter				Wire (AWG)	Raychem SolderTacts Part Number	Size	Polarity	Cable Type
		JOD	SOD	DOD	COD					
Series I, III, and IV										
M39029/60 ^a	—	3.81–5.94 [.150-.234]	3.10–4.32 [.150-.170]	1.52–3.84 [.060-.151]	.48–1.09 [.019-.043]	22–24	D-602-0122	8	P	Coaxial
M39029/59 ^a	—	3.81–5.94 [.150-.234]	3.10–4.32 [.150-.170]	1.52–3.84 [.060-.151]	.48–1.09 [.019-.043]	22–24	D-602-0123	8	S	Coaxial
M39029/76 ^a	915304-1	1.27–2.62 [.050-.103]	1.68–2.13 [.066-.084]	.91–1.73 [.036-.068]	.23–.58 [.009-.023]	26–30	D-602-0140	16	P	Coaxial
M39029/77 ^a	915305-1	1.27–2.62 [.050-.103]	1.68–2.13 [.066-.084]	.91–1.73 [.036-.068]	.23–.58 [.009-.023]	26–30	D-602-0141	16	S	Coaxial
M39029/76 ^a	915304-2	—	—	.64–1.09 [.025-.043]	.23–.58 [.009-.023]	26–30	D-602-0142	16	P	Twisted pair
M39029/77 ^a	915305-2	—	—	.64–1.09 [.025-.043]	.23–.58 [.009-.023]	26–30	D-602-0143	16	S	Twisted pair
M39029/28 ^a	915307-1	1.47–3.10 [.058-.122]	1.68–2.39 [.066-.094]	1.12–2.03 [.044-.080]	.48–.89 [.019-.035]	24–32	D-602-0144	12	P	Coaxial
M39029/75 ^a	915308-1	1.47–3.10 [.058-.122]	1.68–2.39 [.066-.094]	1.12–2.03 [.044-.080]	.48–.89 [.019-.035]	24–32	D-602-0145	12	S	Coaxial
M39029/28 ^a	915307-3	—	—	.74–1.45 [.029-.057]	.48–.89 [.019-.035]	22–26	D-602-0146	12	P	Twisted pair
M39029/75 ^a	915308-3	—	—	.74–1.45 [.029-.057]	.48–.89 [.019-.035]	22–26	D-602-0147	12	S	Twisted pair
M39029/28 ^a	915307-2	1.90–3.81 [.075-.150]	2.54–2.97 [.100-.117]	1.27–2.62 [.050-.103]	.48–.89 [.019-.035]	22, 28	D-602-0150	12	P	Coaxial
M39029/75 ^a	915308-2	1.90–3.81 [.075-.150]	2.54–2.97 [.100-.117]	1.27–2.62 [.050-.103]	.48–.89 [.019-.035]	22, 28	D-602-0151	12	S	Coaxial
—	8340712-OS-01	2.49–3.42 [.098-.135]	1.68–3.05 [.066-.120]	.76–1.24 [.030-.049]	.27–.79 [.011-.031]	24–26	D-602-1108	8	S	Twisted pair ^b
—	8340713-OS-01	2.49–3.42 [.098-.135]	1.68–3.05 [.066-.120]	.76–1.24 [.030-.049]	.27–.79 [.011-.031]	24–26	D-602-1109	8	P	Twisted pair ^b
—	—	2.49–3.76 [.098-.148]	1.68–3.30 [.066-.130]	.91–1.78 [.036-.070]	.23–.89 [.009-.035]	22–26	D-602-1110	8	S	Triaxial
—	—	2.49–3.76 [.098-.148]	1.68–3.30 [.066-.130]	.91–1.78 [.036-.070]	.23–.89 [.009-.035]	22–26	D-602-1111	8	P	Triaxial
—	8340712-OL-01	2.49–3.42 [.098-.135]	1.68–3.05 [.066-.120]	.76–1.24 [.030-.049]	.27–.79 [.011-.031]	24–26	D-602-1112	8	S	Twisted pair ^b
—	8340713-OL-01	2.49–3.42 [.098-.135]	1.68–3.05 [.066-.120]	.76–1.24 [.030-.049]	.27–.79 [.011-.031]	24–26	D-602-1113	8	P	Twisted pair ^b
M39029/90 ^a	8912020-OS-01	3.68 [.145] Max.	—	.64–1.29 [.029-.051]	.27–.74 [.011-.029]	24–26	DK-602-0156-N-1	8	P	Twinaxial ^c
M39029/90 ^a	8912020-DL-01	4.11 [.162] Max.	—	.64–1.29 [.029-.051]	.27–.74 [.011-.029]	24–26	DK-602-0156-N-2	8	P	Twinaxial ^c

a These SolderTacts contacts are intermateable and intermountable with contacts qualified to indicated specification; they replace crimp-style termination.

b These SolderTacts contacts are designed for shielded twisted pair cable per MIL-STD-1553B.

c These SolderTacts contacts are designed for databus contacts per MIL-STD-1553B.

SolderTacts Shielded One-Piece Solder Contacts (Continued)

SolderTacts Series:
MIL-C-38999, Series I, II,
III, IV Circular Connectors
(Continued)

Contact Military Specification	United States Air Force Drawing No.	Cable Diameter (in inches)				Wire (AWG)	Raychem SolderTacts Part Number	Size	Polarity	Cable Type
		JOD	SOD	DOD	COD					
Series I, III, and IV										
M39029/90 ^a	8912020-EL-01	4.50 max. [.177]	—	.74-1.30 [.029-.051]	.24-.74 [.011-.029]	24-26	DK-602-0156-N-3	8	P	Twinaxial ^c
M39029/91 ^a	8912019-OS-01	3.68 max. [.145]	—	.74-1.30 [.029-.051]	.24-.74 [.011-.029]	24-26	DK-602-0157-N-1	8	S	Twinaxial ^c
M39029/91 ^a	8912019-DL-01	4.12 max. [.162]	—	.74-1.30 [.029-.051]	.24-.74 [.011-.029]	24-26	DK-602-0157-N-2	8	S	Twinaxial ^c
M39029/91 ^a	8912019-EL-01	4.50 max. [.177]	—	.74-1.30 [.029-.051]	.24-.74 [.011-.029]	24-26	DK-602-0157-N-3	8	S	Twinaxial ^c
M39029/90 ^a	8912020-OL-01	4.67 max. [.184]	—	—	—	20	DK-602-0169-1	8	P	Twinaxial ^c
M39029/91 ^a	8912019-OL-01	4.67 max. [.184]	—	—	—	20	DK-602-0170-1	8	S	Twinaxial ^c
Series II										
M39029/76 ^a	915304-1	1.27-2.62 [.050-.103]	1.68-2.13 [.066-.084]	.91-1.73 [.036-.068]	.23-.58 [.009-.023]	26-30	D-602-0140	16	P	Coaxial
M39029/77 ^a	915306-1	1.27-2.62 [.050-.103]	1.68-2.13 [.066-.084]	.91-1.73 [.036-.068]	.23-.58 [.009-.023]	26-30	D-602-0171	16	S	Coaxial
M39029/76 ^a	915304-2	—	—	.64-1.09 [.025-.043]	.23-.58 [.009-.023]	26-30	D-602-0142	16	P	Twisted pair
M39029/77 ^a	915306-2	—	—	.64-1.07 [.025-.042]	.23-.58 [.009-.023]	26-30	D-602-0174	16	S	Twisted pair

a These SolderTacts contacts are intermateable and intermountable with contacts qualified to indicated specification; they replace crimp-style termination.

b These SolderTacts contacts are designed for shielded twisted pair cable per MIL-STD-1553B.

c These SolderTacts contacts are designed for databus contacts per MIL-STD-1553B.

Tooling Selection Guide

SolderTacts Series	Part Numbers (D-602-)	Engineering Standard (Termination Instructions)	Convection (Hot Air) Heating AT-1319 Adapter	Repair Wand	Contact Insertion Tool	Contact Removal Tool*
999 Size 16	0140/0141	ES61226	AT-1319-78	AD-1565	M81969/8-07 or M81969/14-03	M81869/8-08 or M81969/14-03
	0142/0143	ES61224	—	—		
	0171	ES61226	AT-1319-27	AD-1572	M81969/8-09 or M81969/14-04	M81969/8-10 or M81969/14-04
	0174	ES61224	—	—		
999 Size 12	0144/0145	ES61206	AT-1319-24	AD-1566	M81969/8-09 or M81969/14-04	M81969/8-10 or M81969/14-04
	0146/0147	ES61218	—	—		
	0150/0151	ES61223	—	—		
999 Size 8	0122/0123	ES61179	AT-1319-22	AD-1568	—	M81969/14-06 or Astro ATBX-2277
	1108/1109	ES61172	—	—		
	1110/1111	ES61172	AT-1319-22 and	AD-1568		
	1112/1113	ES61184		AD-1480		
	0156/0157-X	ES61231	AT-1319-14	AD-1480		
0169/0170-X	ES61235	—	—			

*Tyco Electronics does not provide this tool. See connector manufacturer.

Note:

AA-400 SuperHeater Compressed Air Heating Tool shown on page 10-2 can be used for installation. Another option is the Steinel® General Purpose Hot-Air Heating Tool shown on page 10-13.

SolderTacts Shielded One-Piece Solder Contacts (Continued)

SolderTacts Series:
Subminiature*

SolderTacts Product Construction, Submin Series

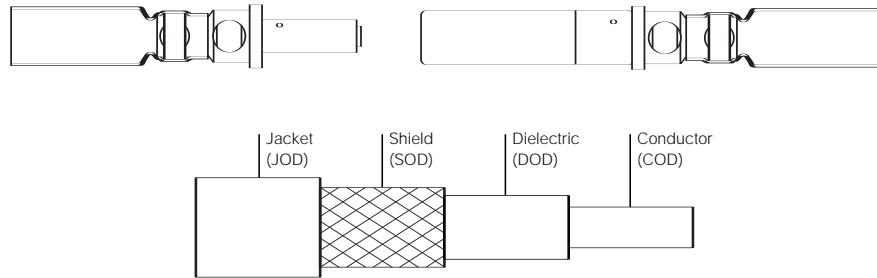

Raychem Cable Diameter

SolderTacts	Size	Polarity	Cable Type	Cable Diameter				(AWG)
				JOD	SOD	DOD	COD	
D-602-0278	16	P	Coaxial	1.52-2.92 [.060-.115]	1.85-2.18 [.073-.086]	.64-1.91 [.025-.075]	.23-.74 [.009-.029]	24-32
D-602-0279	16	S	Coaxial	1.52-2.92 [.060-.115]	1.85-2.18 [.073-.086]	.64-1.91 [.025-.075]	.23-.74 [.009-.029]	24-32
D-602-0288	16	P	Twisted pair	—	—	.74-1.40 [.029-.055]	.23-.74 [.009-.029]	24-32
D-602-0289	16	S	Twisted pair	—	—	.74-1.40 [.029-.055]	.23-.74 [.009-.029]	24-32

*These SolderTacts contacts belong to the Raychem "Subminiature" series of contacts, which are designed for use in commercial connectors.

Tooling Selection Guide

SolderTacts Series	Part Numbers (D-602-)	Engineering Standard (Termination Instructions)	Convection (hot air) Heating AT-1319 Adapter	Repair Wand	Contact Insertion Tool	Contact Removal Tool
Submin	0278/0279	ES61170	AT-1319-12	AD-1481	*	AD-1447
—	0288/0289	ES61414	—	—	—	—

*Not applicable.

Note:

AA-400 SuperHeater Compressed Air Heating Tool shown on page 10-2 can be used for installation. Another option is the Steinel® General Purpose Hot-Air Heating Tool shown on page 10-13.

SolderTacts Series:
MIL-C-83723

Contact Military Specification*	Cable Diameter				Wire (AWG)	Raychem SolderTacts	Size	Polarity	Cable Type
	JOD	SOD	DOD	COD					
M39029/74-400	2.39-3.56 [.094-.140]	1.96-2.49 [.077-.098]	1.32-2.06 [.052-.081]	.28-.74 [.011-.029]	24-32	D-602-0094	12	P	Coaxial
M39029/73-397	2.39-3.56 [.094-.140]	1.96-2.49 [.077-.098]	1.32-2.06 [.052-.081]	.28-.74 [.011-.029]	24-32	D-602-0095	12	S	Coaxial
M39029/74-401	—	—	.74-1.45 [.029-.057]	.28-.74 [.011-.029]	24-32	D-602-0104	12	P	Twisted pair
M39029/73-398	—	—	.74-1.45 [.029-.057]	.28-.74 [.011-.029]	24-32	D-602-0105	12	S	Twisted pair
M39029/74-399	3.05-3.68 [.120-.145]	3.10-3.15 [.122-.124]	2.36-2.67 [.093-.105]	.28-.74 [.011-.029]	24-32	D-602-0106	12	P	Large coaxial
M39029/73-396	3.05-3.68 [.120-.145]	3.10-3.15 [.122-.124]	2.36-2.67 [.093-.105]	.28-.74 [.011-.029]	24-32	D-602-0107	12	S	Large coaxial

* These SolderTacts contacts are on qualified parts list for indicated specification.

Tooling Selection Guide

Raychem SolderTacts Part Number	Engineering Standard (Termination Instructions)	Convection (Hot Air) Heating AT-1319 Adapter	Repair Wand	Contact Insertion Tool	Contact Removal Tool	Special Tools
D-602-0094/0095	ES61128	AT-1319-19	AD-1494	AD-1527	AD-1527	AD-1496
D-602-0106/0107	ES61134	Rev. D	Rev. C	(M81969/14-04)	(M81969/14-04)	(twisted)
D-602-0104/0105	ES61129	—	—	—	—	—

Note:

AA-400 SuperHeater Compressed Air Heating Tool shown on page 10-2 can be used for installation. Another option is the Steinel® General Purpose Hot-Air Heating Tool shown on page 10-13.

SolderTacts Series:
DOD-C-83527

Raychem SolderTacts Reference	Size	Polarity	Cable Type	Contact Military Specification
D-602-0185	16	socket	Coaxial	—
D-602-0094	12	pin	Coaxial	M39029/74
D-602-0093*	12	socket	Coaxial	M39029/73
D-602-0106	12	pin	Coax (large)	M39029/74
D-602-0189*	12	socket	Coax (large)	M39029/73

*These SolderTacts contacts are intermateable with M39029/73, but are not on QPL.

SolderTacts Series:
DOD-C-83527
(data bus contacts)**

Raychem SolderTacts Reference	Size	Polarity	Cable Type	Contact Military Specification
D-602-0186	8	pin	Twisted pair	M39029/96
D-602-0187	8	socket	Twisted pair	M39029/95
DK-602-0186-2	8	pin	Sh. twisted pair	M39029/96
DK-602-0187-2	8	socket	Sh. twisted pair	M39029/95

** These SolderTacts contacts are designed for shielded twisted pair cable per MIL-STD-1553B.

**SolderTacts Series:
Grommets****Performance**

The performance of SolderTacts contacts is defined by the applicable Raychem specification control drawing (SCD) and Raychem Specification D-6002. Products on qualified product lists meet the requirements of the base specification.

Termination

Termination of SolderTacts contacts is defined in the appropriate Raychem Engineering Standard. To obtain a copy, contact Tyco Electronics.

SolderTacts Shielded One-Piece Solder Contacts (Continued)

Raychem SolderTacts Reference	Size	Polarity
D-600-0071	—	For shielded twisted pair
D-600-0116	For size 8 DOD-C-83527 series	—
D-600-0125	For size 8 MIL-C-38999 series, for twisted pair	—



Introduction



The full line of Raychem data bus products offers a complete system of inter-connection hardware for all MIL-STD-1553B multiplexing needs.

Available components include:

- Couplers (micros, boxes, flat packs)
- Data bus cables
- Triax connectors and contacts with strain relief
- One-piece triaxial contacts for MIL-C-38999 connectors (size 8 cavity)
- Bus and stub terminators
- Cable marker sleeves (TMS)
- Lightweight couplers (see pages 8-82 to 8-84)
- Space components (see pages 8-95 to 8-97)
- Harness design (HarnWare)

All Raychem data bus components offer:

- High packaging density and weight savings
- Design flexibility
- High performance (to 150°C [302°F] rating)

Raychem MIL-STD-1553B data bus components are also specified in the Air Force drawings listed in Air Force Drawing 8340707.

Tyco Electronics also supplies complete Raychem data bus networks in accordance with customer harness drawings. Using factory-built harnesses eliminates unnecessary splices and connectors, reducing the cost and increasing the reliability of the networks. Factory-built harnesses are pre-tested and ready for installation.

Cables

Product Facts

- Light weight
- Highly flexible
- Flame resistant
- Chemical resistant to all aircraft fluids
- Solder iron resistant
- Defined shielding levels

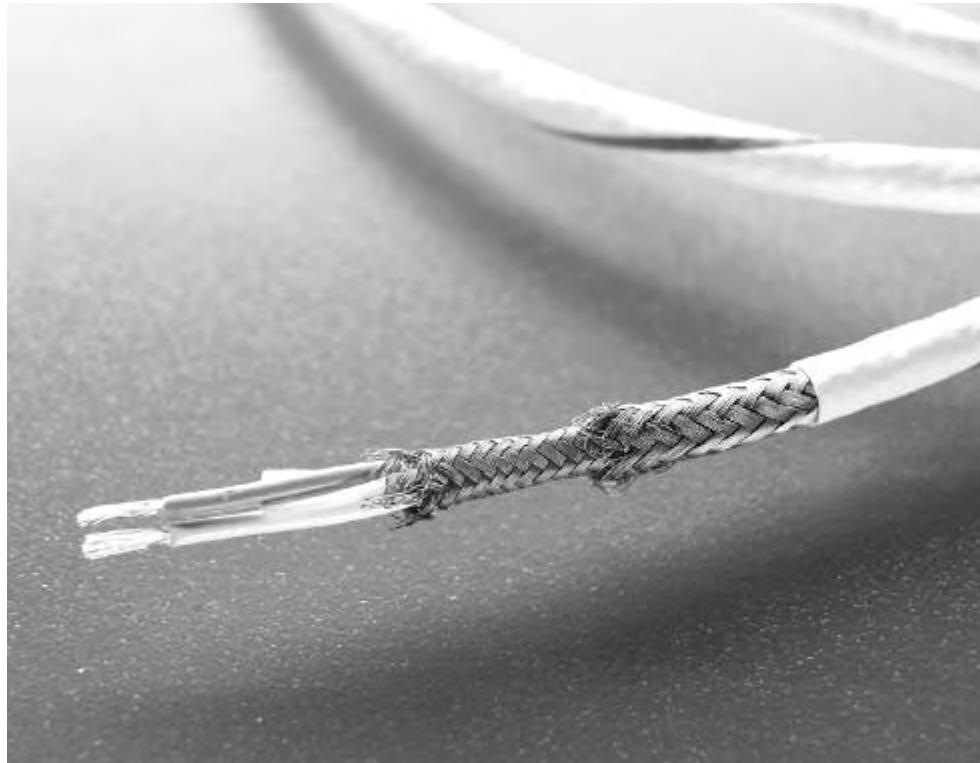

Applications





Tyco Electronics manufactures a line of Raychem SPEC 55 data bus cables that meet or exceed the performance requirements of MIL-STD-1553B.

SPEC 55 insulation is a high-temperature, radiation-crosslinked, modified ETFE material that can be used in wire constructions rated up to 200°C [392°F].

Note: Tyco Electronics will build harnesses with any customer specified cables and/or connectors.

Cables (Continued)

Series	Military
SPEC 55 insulation	MIL-W-22759/32-35
	MIL-W-22759/41-46

Cable Type		Part No.
24 AWG Single Optimized Shield		10612
24 AWG Double Optimized Shield		10613
24 AWG EMP Hardened		10614
24 AWG Flat Shield, Unfilled		7724 H 0664

In-Line Microcouplers: One- and Two-Stub

Product Facts

- Environmental sealing
- No connectors
- Very small size
- Light weight (1 stub: 10 g max.; 2 stubs: 15 g max.)
- In-line profile that makes wire bundle mounting possible
- 360° continuous low-impedance cable-shield terminations
- Reliable solder termination of all components
- Potted circuit elements for maximum durability and in-use reliability
- Ease of installation
- Altitude immersion resistance
- Optional eyelet configurations for bulkhead mounting
- Mean time between failures > 1,000,000 hours



Applications

The low-profile configuration of these couplers enables avionics system designers to plan for optimum coupler locations. Microcouplers are supplied with Raychem SPEC 55 data bus cables,

including EMP-hardened versions. They are also available assembled with other components into a complete data bus harness.

Specifications/Approvals











Series	Military	Raychem
D-500-04	MIL-STD-1553B	D-6020

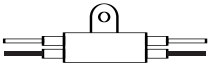

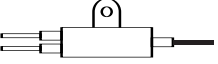
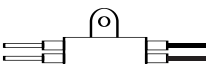
Available in:

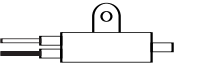
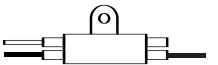
Americas	■
Europe	■
Asia Pacific	■

Product Selection

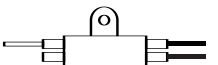
In-Line Microcouplers: One- and Two-Stub (Continued)

Single Stub		Double Stub	
D-500-0455-1-YYY-ZZZ		D-500-0455-2-YYY-ZZZ	
D-500-0465-1-YYY-ZZZ		D-500-0465-2-YYY-ZZZ	
D-500-0456-1-YYY-ZZZ		D-500-0456-2-YYY-ZZZ	
D-500-0466-1-YYY-ZZZ		D-500-0466-2-YYY-ZZZ	
D-500-0457-1-YYY-ZZZ		D-500-0457-2-YYY-ZZZ	
D-500-0467-1-YYY-ZZZ		D-500-0467-2-YYY-ZZZ	
D-500-0458-1-YYY-ZZZ		D-500-0458-2-YYY-ZZZ	
D-500-0468-1-YYY-ZZZ		D-500-0468-2-YYY-ZZZ	

Note:
 1. Bus cable 
 2. Stub cable 

In-Line Microcouplers: One- and Two-Stub (Continued)

D-500-04W W-X-YYY-ZZZ

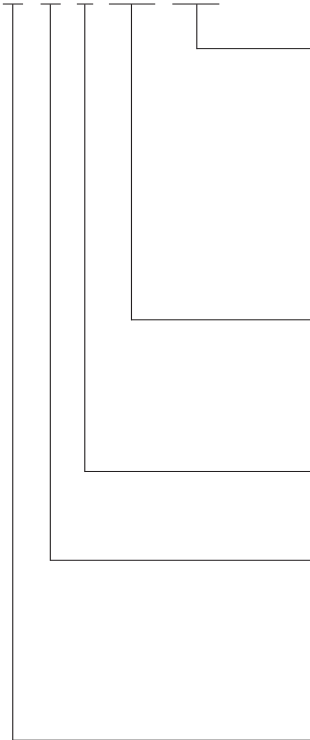

Standard Cable Length

- 012 = 12 in (1 ft)
- 078 = 78 in (6.5 ft)
- 079 = 79 in (2 m)
- 120 = 120 in (10 ft)
- 236 = 236 in (6 m)
- 240 = 240 in (20 ft)
- 360 = 360 in (30 ft)

Cable Type

- 612 = 1061224 AWG single optimized shield
- 613 = 1061324 AWG double optimized shield
- 614 = 1061424 AWG EMP hardened
- H06 = 7724H0664 (24 AWG Flat Wire Unfilled)

Number of Stubs

- 1 or 2

Design

- 5 = Without internal terminator
- 6 = Same as 5 but with reverse bus
- 7 = With internal terminator
- 8 = Same as 7 but with reverse bus

Boot

- 5 = Without mounting eyelet
- 6 = With mounting eyelet



Ultra Lightweight In-Line Microcouplers 1- Through 6-Stub

Product Facts

- Environmental sealing
- No connectors
- Very small size
- Ultra Light weight
(1 stub: 6.5 g max.; 2 stubs: 9.5 g max.)
- In-line profile that makes wire bundle mounting possible
- 360° continuous low-impedance cable-shield terminations
- Reliable solder termination of all components
- Potted circuit elements for maximum durability and in-use reliability
- Ease of installation
- Altitude immersion resistance
- Mean time between failures > 1,000,000 hours

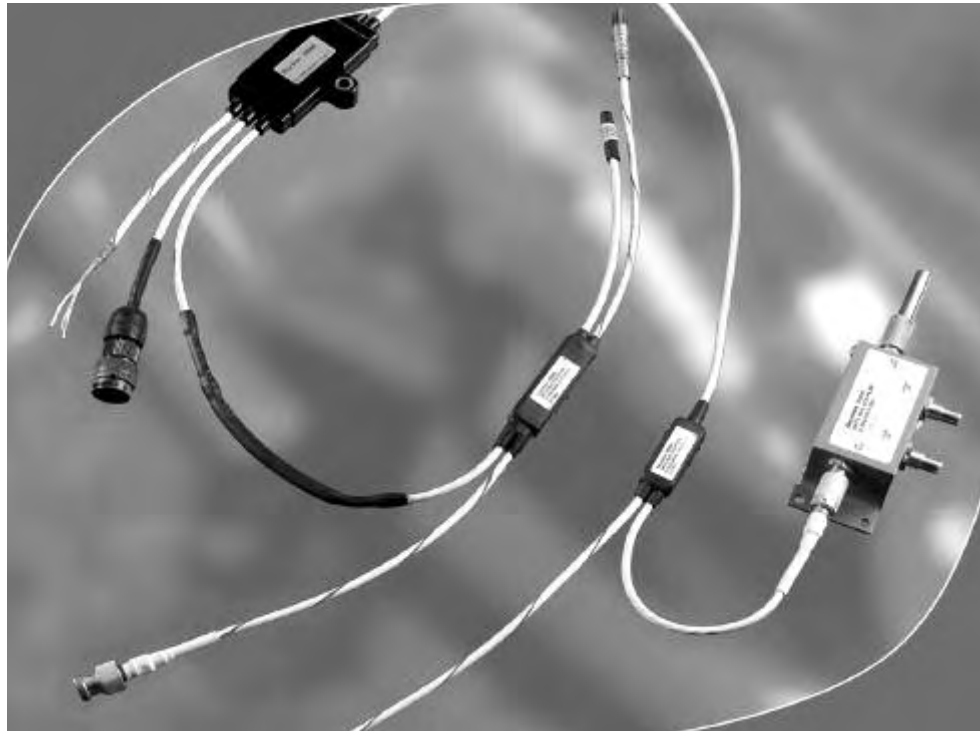

Applications

Building on over 20 years of experience and continuous improvement in data bus, including pioneering in-line microcouplers, Tyco Electronics introduces a new family of ultra light-weight In-line Raychem Microcouplers, available in 1- through 6-stub configurations.

These couplers offer the same high performance and reliability as Raychem current microcouplers, but their weight is further reduced. They are available in configurations up to 6-stub, and minimize weight there is no option with a mounting eyelet.

Combined with Raychem 24 AWG data bus cables, these ultra light couplers

allow designers to significantly reduce weight. An unfilled flat braid cable is available for additional weight savings.

They are also available assembled with other customer specified components into a complete factory-built and tested data bus harness.

Specifications/approvals

Series	Military	Raychem
D-500-L4xx	MIL-STD-1553B	D-6020 (same as current microcouplers)

Available in:

- Americas ■
- Europe ■
- Asia Pacific ■

D-500-L4 5 W -X -YYY -ZZZ

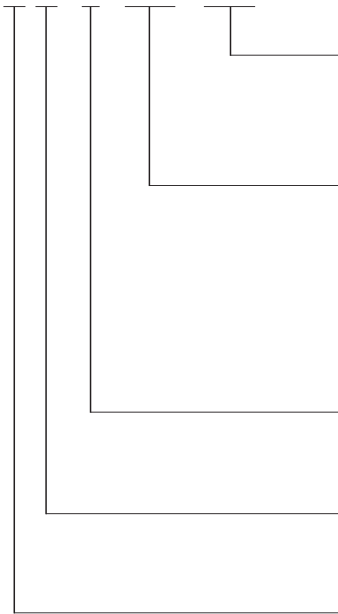

Cable Length

012 = 12 in 079 = 79 in 236 = 236 in
078 = 78 in 120 = 120 in 240 = 240 in
360 = 360 in

Cable Type

612 = 10612 (24 AWG single optimized shield)
613 = 10613 (24 AWG double optimized shield)
614 = 10614 (24 AWG EMP hardened)
H06 = 7724H0664 (24 AWG flat shield, unfilled)
Lightest cable

Number of Stubs

1, 2, 3, 4, 5 or 6

Design

5 = Without internal terminator
7 = With internal terminator

Style

5 = Without eyelet

Product Selection

D-500-L455-X-YYY-ZZZ

End View Left Side		End View Right Side
	1 stub	
	2 stub	
	3 stub	
	4 stub	
	5 stub	
	6 stub	

D-500-L456-X-YYY-ZZZ

End View Left Side		End View Right Side
	1 stub	
	2 stub	
	3 stub	
	4 stub	
	5 stub	
	6 stub	

D-500-L457-X-YYY-ZZZ

End View Left Side		End View Right Side
	1 stub	
	2 stub	
	3 stub	
	4 stub	
	5 stub	
	6 stub	

D-500-L458-X-YYY-ZZZ

End View Left Side		End View Right Side
	1 stub	
	2 stub	
	3 stub	
	4 stub	
	5 stub	
	6 stub	

Legend

- Bus cable ○
- Stub cable ●

Box Couplers

Product Facts

- Light, robust coupler modules with connector versatility
- Up to eight stub connectors can be arrayed on the “face” of the box coupler. Bus connectors can also be on the “face” or on the “side” of the box
- Designed with Raychem D-621 series corrosion-resistant threaded-type or bayonet-type connectors



Applications

The multiport capability of these couplers (up to eight stubs) enables avionics system designers to interconnect black boxes with minimum wire runs. Box couplers are supplied with Raychem triaxial threaded or bayonet connectors.

Note: Tyco Electronics also designs and manufactures customized Raychem data bus box couplers.

Specifications/Approvals

Series	Military	Raychem
D-500-0255	MIL-STD-1553	D-6021

Available in:	
Americas	■
Europe	■
Asia Pacific	■

Catalog 1654025
Revised 12-04
www.tycoelectronics.com

Dimensions are in millimeters and inches unless otherwise specified. Values in brackets are U.S. equivalents.

Dimensions are shown for reference purposes only. Specifications subject to change.

USA: 1-800-522-6752
Canada: 1-905-470-4425
Mexico: 01-800-733-8926
C. America: 52-55-5-729-0425

South America: 55-11-3611-1514
Japan: 81-44-900-5102
Singapore: 65-4866-151
UK: 44-1793-528171

Box Couplers (Continued)

Coupler Type	Part No.			
	Threaded	Bayonet A*	Bayonet B*	Bayonet C*
Face - 1 Stub	D-500-0255-511-1	D-500-0255-513-1	D-500-0255-515-1	D-500-0255-517-1
Face - 2 Stub	D-500-0255-521-1	D-500-0255-523-1	D-500-0255-525-1	D-500-0255-527-1
Face - 3 Stub	D-500-0255-531-1	D-500-0255-533-1	D-500-0255-535-1	D-500-0255-537-1
Face - 4 Stub	D-500-0255-541-1	D-500-0255-543-1	D-500-0255-545-1	D-500-0255-547-1
Face - 5 Stub	D-500-0255-551-1	D-500-0255-553-1	D-500-0255-555-1	D-500-0255-557-1
Face - 6 Stub	D-500-0255-561-1	D-500-0255-563-1	D-500-0255-565-1	D-500-0255-567-1
Face - 7 Stub	D-500-0255-571-1	D-500-0255-573-1	D-500-0255-575-1	D-500-0255-577-1
Face - 8 Stub	D-500-0255-581-1	D-500-0255-583-1	D-500-0255-585-1	D-500-0255-587-1
Side - 1 Stub	D-500-0255-512-1	D-500-0255-513-2	D-500-0255-515-2	D-500-0255-517-2
Side - 2 Stub	D-500-0255-522-1	D-500-0255-523-2	D-500-0255-525-2	D-500-0255-527-2
Side - 3 Stub	D-500-0255-532-1	D-500-0255-533-2	D-500-0255-535-2	D-500-0255-537-2
Side - 4 Stub	D-500-0255-542-1	D-500-0255-543-2	D-500-0255-545-2	D-500-0255-547-2
Side - 5 Stub	D-500-0255-552-1	D-500-0255-553-2	D-500-0255-555-2	D-500-0255-557-2
Side - 6 Stub	D-500-0255-562-1	D-500-0255-563-2	D-500-0255-565-2	D-500-0255-567-2
Side - 7 Stub	D-500-0255-572-1	D-500-0255-573-2	D-500-0255-575-2	D-500-0255-577-2
Side - 8 Stub	D-500-0255-582-1	D-500-0255-583-2	D-500-0255-585-2	D-500-0255-587-2

*The bayonet polarization listed is for the bus connector. All stub connectors are Bayonet D polarization. Polarizations are depicted as follows (jack view):

1 = A



2 = B



3 = C



4 = D



Discrete Connectors

Product Facts

- Compliance with MIL-STD-1553B hardware requirements
- Light weight
- Removable pin or socket contacts
- Termination with Raychem MIL-STD-1553B data bus cables, including EMP-hardened versions
- Continuous 360° shield coverage
- Rugged constructions
- Termination time of 1 to 2 minutes
- Inspectable solder terminations
- Low-skill assembly
- Reworkable and repairable terminations
- Strain relief built into the design
- Low-voltage drop and high reliability because of precisely controlled solder terminations
- Threaded and bayonet coupling styles
- Low total installed cost
- 1000-hour salt spray resistance
- Lower-cost connectors, for benchtop and mock-up



Applications

Designed specifically for MIL-STD-1553B data bus applications, the D-621 connector is intended to be a perfect match for the Raychem airworthy data bus cable. Together they provide durable, reliable, and reworkable interconnection hardware for the MIL-STD-1553B market.



Specifications/Approvals

Series	Military	Raychem
DK-621	MIL-STD-1553B	D-6025

Available in:	
Americas	■
Europe	■
Asia Pacific	■

Catalog 1654025
Revised 12-04
www.tycoelectronics.com

Dimensions are in millimeters and inches unless otherwise specified. Values in brackets are U.S. equivalents.

Dimensions are shown for reference purposes only. Specifications subject to change.

USA: 1-800-522-6752
Canada: 1-905-470-4425
Mexico: 01-800-733-8926
C. America: 52-55-5-729-0425

South America: 55-11-3611-1514
Japan: 81-44-900-5102
Singapore: 65-4866-151
UK: 44-1793-528171

DK-621-04 XX-XX

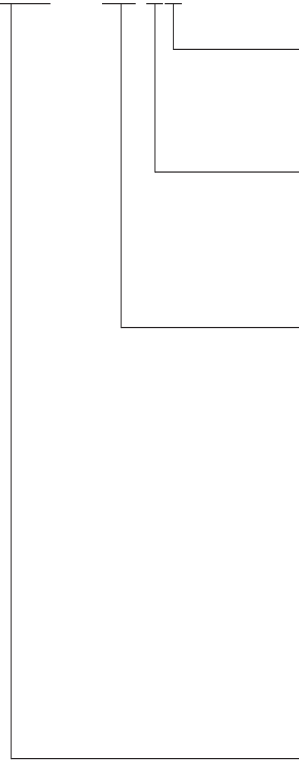

Contact (supplied in DK-621 kits only)

P = Pin

S = Socket

Polarization (bayonet styles only) (jack view)

1 = A

2 = B

3 = C

4 = D



Basic Connector Configurations

Threaded styles

11 = Plug

12 = Jack

Bayonet styles

33 = Plug, A polarization

34 = Jack, A polarization

35 = Plug, B polarization

36 = Jack, B polarization

37 = Plug, C polarization

38 = Jack, C polarization

39 = Plug, D polarization

40 = Jack, D polarization

D-621 connector, kitted with accessories

Example:

DK-621-0434-1P = D-621 connector, kitted with accessories, jack bayonet style with A polarization and pin contact.

Accessories

Product Facts

- A single source for all harness components
- Products designed to work together



Available in:	
Americas	■
Europe	■
Asia Pacific	■

Applications

Tyco Electronics manufactures all the products needed to build a MIL-STD-1553B data bus network. In addition to the main components (couplers, connectors, contacts, and cables), Tyco Electronics supplies the accessory components that may be necessary to complete a data bus system.

These include:

- Bus and stub terminators (spliced-in and connectorized D-621 series).
- Cable splice kits.
- EMI/environment-resistant connector caps.
- Braid terminators and strain relief tubing (for rework applications).
- Cable marking materials.

Product Selection

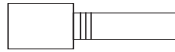

D-621 Plug

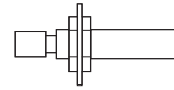

D-621 Jack



Splice-in

Bus and Stub Terminators

Spliced-in	12-inch Cable				
77-ohm 10612 cable	D-500-0463-612				
77-ohm 10613 cable	D-500-0463-613				
77-ohm 10614 cable	D-500-0463-614				
77-ohm 7724H0664 cable	D-500-0463-H06				
D-621 Series—Plug	Threaded	Bayonet A	Bayonet B	Bayonet C	Bayonet D
77-ohm pin contact	D-621-0413	D-621-0453	D-621-0454	D-621-0455	D-621-0456
77-ohm socket contact	D-621-0415	D-621-0469	D-621-0470	D-621-0471	D-621-0472
3000-ohm pin contact	D-621-0417	D-621-0457	D-621-0458	D-621-0459	D-621-0476
3000-ohm socket contact	D-621-0407	D-621-0473	D-621-0474	D-621-0475	D-621-0460
D-621 Series—Jack	Threaded	Bayonet A	Bayonet B	Bayonet C	Bayonet D
77-ohm pin contact	D-621-0418	D-621-0477	D-621-0478	D-621-0479	D-621-0480
77-ohm socket contact	D-621-0406	D-621-0461	D-621-0462	D-621-0463	D-621-0464
3000-ohm pin contact	D-621-0423	D-621-0481	D-621-0482	D-621-0483	D-621-0484
3000-ohm socket contact	D-621-0424	D-621-0465	D-621-0466	D-621-0467	D-621-0468
D-621 Series—L	Lanyard 7"	—	—	—	—

Connector Caps



D-621 Series	Threaded	Bayonet A	Bayonet B	Bayonet C	Bayonet D
Plug cap for jack connector Supplied with 7" Lanyard	D-600-0083	D-600-0068	D-600-0068	D-600-0068	D-600-0065

Cable Splice Kits

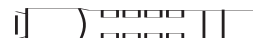

Cables	Flexible Crimp
All data bus cables	D-150-0708-5

Terminator and Connector and Compatibility — Bayonet and Threaded Connectors

Panel Thickness	Connector	Contact	Terminator Reference	Mate with	
				Standard Connector	Long Reach Connector
Bayonet Connectors					
Polarity A					
77 Ohm bus terminator	Plug	Pin	D-621-0453(-L)	DK-621-0434-1S	DK-621-0550-1S
	Plug	Socket	D-621-0469(-L)	DK-621-0434-1P	DK-621-0550-1P
	Jack	Pin	D-621-0477(-L)	DK-621-0433-1S	—
	Jack	Socket	D-621-0461(-L)	DK-621-0433-1P	—
3K Ohm stub terminator	Plug	Pin	D-621-0457(-L)	DK-621-0434-1S	DK-621-0550-1S
	Plug	Socket	D-621-0473(-L)	DK-621-0434-1P	DK-621-0550-1P
	Jack	Pin	D-621-0481(-L)	DK-621-0433-1S	—
	Jack	Socket	D-621-0465(-L)	DK-621-0433-1P	—
Polarity B					
77 Ohm bus terminator	Plug	Pin	D-621-0454(-L)	DK-621-0436-2S	DK-621-0548-2S
	Plug	Socket	D-621-0470(-L)	DK-621-0436-2P	DK-621-0548-2P
	Jack	Pin	D-621-0478(-L)	DK-621-0435-2S	—
	Jack	Socket	D-621-0462(-L)	DK-621-0435-2P	—
3K Ohm stub terminator	Plug	Pin	D-621-0458(-L)	DK-621-0436-2S	DK-621-0548-2S
	Plug	Socket	D-621-0474(-L)	DK-621-0436-2P	DK-621-0548-2P
	Jack	Pin	D-621-0482(-L)	DK-621-0435-2S	—
	Jack	Socket	D-621-0466(-L)	DK-621-0435-2P	—
Polarity C					
77 Ohm bus terminator	Plug	Pin	D-621-0455(-L)	DK-621-0438-3S	DK-621-0546-3S
	Plug	Socket	D-621-0471(-L)	DK-621-0438-3P	DK-621-0546-3P
	Jack	Pin	D-621-0479(-L)	DK-621-0437-3S	—
	Jack	Socket	D-621-0463(-L)	DK-621-0437-3P	—
3K Ohm stub terminator	Plug	Pin	D-621-0459(-L)	DK-621-0438-3S	DK-621-0546-3S
	Plug	Socket	D-621-0475(-L)	DK-621-0438-3P	DK-621-0546-3P
	Jack	Pin	D-621-0483(-L)	DK-621-0437-3S	—
	Jack	Socket	D-621-0467(-L)	DK-621-0437-3P	—
Polarity D					
77 Ohm bus terminator	Plug	Pin	D-621-0456(-L)	DK-621-0440-4S	DK-621-0551-4S
	Plug	Socket	D-621-0472(-L)	DK-621-0440-4P	DK-621-0551-4P
	Jack	Pin	D-621-0480(-L)	DK-621-0439-4S	—
	Jack	Socket	D-621-0464(-L)	DK-621-0439-4P	—
3K Ohm stub terminator	Plug	Pin	D-621-0460(-L)	DK-621-0440-4S	DK-621-0551-4S
	Plug	Socket	D-621-0476(-L)	DK-621-0440-4P	DK-621-0551-4P
	Jack	Pin	D-621-0468(-L)	DK-621-0439-4S	—
	Jack	Socket	D-621-0484(-L)	DK-621-0439-4P	—
Threaded Connectors					
77 Ohm bus terminator	Plug	Pin	D-621-0413(-L)	DK-621-0412-S	DK-621-0512-S
	Plug	Socket	D-621-0415(-L)	DK-621-0412-P	DK-621-0512-P
	Jack	Pin	D-621-0418(-L)	DK-621-0411-S	—
	Jack	Socket	D-621-0406(-L)	DK-621-0411-P	—
3K Ohm stub terminator	Plug	Pin	D-621-0417(-L)	DK-621-0412-S	DK-621-0512-S
	Plug	Socket	D-621-0407(-L)	DK-621-0412-P	DK-621-0512-P
	Jack	Pin	D-621-0423(-L)	DK-621-0411-S	—
	Jack	Socket	D-621-0424(-L)	DK-621-0411-P	—

Triaxial Connectors and Terminator Compatibility — Bayonet and Threaded Connectors

Panel Thickness	Connector	Contact	Connector Reference	Mate with		
				Connector	77 Ohm Bus Terminator	3K Ohm Stub Terminator
Bayonet Connectors						
Polarity A						
	Plug	Pin	DK-621-0433-1P	DK-621-0434-1S	D-621-0461(-L)	D-621-0465 (-L)
	Plug	Socket	DK-621-0433-1S	DK-621-0434-1P	D-621-0477(-L)	D-621-0481(-L)
Standard	Jack	Pin	DK-621-0434-1P	DK-621-0433-1S	D-621-0461(-L)	D-621-0473(-L)
2.4mm max.	Jack	Socket	DK-621-0434-1S	DK-621-0433-1P	D-621-0453(-L)	D-621-0457(-L)
Long Reach	Jack	Pin	DK-621-0550-1P	DK-621-0433-1S	D-621-0469(-L)	D-621-0473(-L)
12.5mm max.	Jack	Socket	DK-621-0550-1S	DK-621-0433-1P	D-621-0453(-L)	D-621-0457(-L)
Polarity B						
	Plug	Pin	DK-621-0435-2P	DK-621-0436-2S	D-621-0462(-L)	D-621-0474 (-L)
	Plug	Socket	DK-621-0435-2S	DK-621-0436-2P	D-621-0478(-L)	D-621-0458(-L)
Standard	Jack	Pin	DK-621-0436-2P	DK-621-0435-2S	D-621-0470(-L)	D-621-0474(-L)
2.4mm max.	Jack	Socket	DK-621-0436-2S	DK-621-0435-2P	D-621-0454(-L)	D-621-0458(-L)
Long Reach	Jack	Pin	DK-621-0448-2P	DK-621-0435-2S	D-621-0470(-L)	D-621-0467(-L)
12.5mm max.	Jack	Socket	DK-621-0448-2S	DK-621-0435-2P	D-621-0454(-L)	D-621-0483(-L)
Polarity C						
	Plug	Pin	DK-621-0437-3P	DK-621-0438-3S	D-621-0463(-L)	D-621-0467(-L)
	Plug	Socket	DK-621-0437-3S	DK-621-0438-3P	D-621-0479(-L)	D-621-0483(-L)
Standard	Jack	Pin	DK-621-0438-3P	DK-621-0437-3S	D-621-0471(-L)	D-621-0475(-L)
2.4mm max.	Jack	Socket	DK-621-0438-3S	DK-621-0437-3P	D-621-0455(-L)	D-621-0459(-L)
Long Reach	Jack	Pin	DK-621-0446-3P	DK-621-0437-3S	D-621-0471(-L)	D-621-0475(-L)
12.5mm max.	Jack	Socket	DK-621-0446-3S	DK-621-0437-3P	D-621-0455(-L)	D-621-0459(-L)
Polarity D						
	Plug	Pin	DK-621-0439-4P	DK-621-0440-4S	D-621-0464(-L)	D-621-0468(-L)
	Plug	Socket	DK-621-0439-4S	DK-621-0440-4P	D-621-0480(-L)	D-621-0484(-L)
Standard	Jack	Pin	DK-621-0440-4P	DK-621-0439-4S	D-621-0472(-L)	D-621-0476(-L)
2.4mm max.	Jack	Socket	DK-621-0440-4S	DK-621-0439-4P	D-621-0456(-L)	D-621-0460(-L)
Long Reach	Jack	Pin	DK-621-0551-4P	DK-621-0439-4S	D-621-0472(-L)	D-621-0476(-L)
12.5mm max.	Jack	Socket	DK-621-0551-4S	DK-621-0439-4P	D-621-0456(-L)	D-621-0460(-L)
Threaded Connectors						
	Plug	Pin	DK-621-0411-P	DK-621-0412-S	D-621-0406(-L)	D-621-0424(-L)
	Plug	Socket	DK-621-0411-S	DK-621-0412-P	D-621-0418(-L)	D-621-0423(-L)
Standard	Jack	Pin	DK-621-0412-P	DK-621-0411-S	D-621-0415(-L)	D-621-0407(-L)
2.4mm max.	Jack	Socket	DK-621-0412-S	DK-621-0411-P	D-621-0413(-L)	D-621-0417(-L)
Long Reach	Jack	Pin	DK-621-0412-P	DK-621-0411-S	D-621-0415(-L)	D-621-0407(-L)
12.5mm max.	Jack	Socket	DK-621-0412-S	DK-621-0411-P	D-621-0413(-L)	D-621-0417(-L)

Triaxial Connectors and Terminator Compatibility — to European norme 3716

Panel Thickness	Connector	Contact	Connector Reference	Mate with		
				Connector	77 Ohm Bus Terminator	3K Ohm Stub Terminator
Triaxial Connectors						
Standard 2.4mm max.	Plug	Pin	DK-3716-F101-TP	DK-621-E102-TS	D-621-E077-S	D-621-E03K-S
	Plug	Socket	DK-3716-F101-TS	DK-621-E102-TP	D-621-E077-P	D-621-E03K-P
	Plug	Pin	DK-3716-F201-TP	DK-621-E202-TS	D-621-E077-S	D-621-E03K-S
	Plug	Socket	DK-3716-F201-TS	DK-621-E202-TP	D-621-E077-P	D-621-E03K-P
	Jack	Pin	DK-3716-E102-TP	DK-621-F101-TS	D-621-F077-S	D-621-F03K-S
	Jack	Socket	DK-3716-E102-TS	DK-621-F101-TP	D-621-F077-P	D-621-F03K-P
	Jack	Pin	DK-3716-E202-TP	DK-621-F201-TS	D-621-F077-S	D-621-F03K-S
	Jack	Socket	DK-3716-E202-TS	DK-621-F201-TP	D-621-F077-P	D-621-F03K-P
Long Reach 12.5mm max.	Jack	Pin	DK-3716-E112-TP	DK-621-F101-TS	D-621-F077-S	D-621-F03K-S
	Jack	Socket	DK-3716-E112-TS	DK-621-F101-TP	D-621-F077-P	D-621-F03K-P
	Jack	Pin	DK-3716-E212-TP	DK-621-F201-TS	D-621-F077-S	D-621-F03K-S
	Jack	Socket	DK-3716-E212-TS	DK-621-F201-TP	D-621-F077-P	D-621-F03K-P

Panel Thickness	Connector	Contact	Terminator Reference	Mate with	
				Standard Connector	Long Reach Connector
Terminators					
77 Ohm bus terminator	Plug	Pin	DK-3716-F077-P	DK-3716-E#02-TS	DK-3716-E#12K-TS
	Plug	Socket	DK-3716-F077-S	DK-3716-E#02-TP	DK-3716-E#12K-TP
	Jack	Pin	DK-3716-F077-P	DK-3716-E#01-TS	—
	Jack	Socket	DK-3716-F077-S	DK-3716-E#01-TP	—
3K Ohm stub terminator	Plug	Pin	DK-3716-E03K-P	DK-3716-E#02-TS	DK-3716-E#12K-TS
	Plug	Socket	DK-3716-E03K-S	DK-3716-E#02-TP	DK-3716-E#12K-TP
	Jack	Pin	DK-3716-E03K-P	DK-3716-E#01-TS	—
	Jack	Socket	DK-3716-E03K-S	DK-3716-E#01-TP	—



Triaxial Size 8 Contacts

Product Facts

- One-step termination
- Termination time of 1 to 2 minutes
- No requirements for special termination tools
- No requirements for special skills
- Reworkable and repairable terminations
- Strain relief
- Continuous 360° shield coverage
- Triaxial mating face for least susceptibility to damage
- Rugged construction, because only two parts are being soldered together
- Inspectable solder terminations
- Low voltage drop and high reliability due to precisely controlled solder termination



Applications

Contacts provide full shield coverage with a simple, quick, and reliable termination system. 24 AWG twisted-pair data bus cables are terminated with triaxial SolderTacts contacts, which fit size 8 cavities of MIL-C-38999, Series 1, 3, or 4 connectors.

Raychem size 8 triaxial data bus contacts for MIL-C-38999 connectors have interfaces that comply with MIL-C-39029/90 and /91 to provide ease of termination, and intermateability with more cumbersome crimp contacts.

These contacts provide a fast and convenient method of implementing MIL-STD-1553B connections in MIL-STD-1760 applications.

Specifications/Approvals

Series	Raychem
Size 8	D-6002

Product Selection

Cable Type	Pin	Socket
10612	DK-602-0156-N-1	DK-602-0157-N-1
10613	DK-602-0156-N-2	DK-602-0157-N-2
10614	DK-602-0156-N-3	DK-602-0157-N-3

Available in:

- Americas ■
- Europe ■
- Asia Pacific ■

Product Facts

- Complete line of space-qualified MIL-STD-1553B components
- Low outgassing levels that meet NASA requirements
- Light weight
- Rugged construction



Figure 1. In-line couplers and terminators



Figure 2. Threaded triaxial connectors



Figure 3. Bayonet triaxial connectors



Figure 4. Splice kit



Applications

Tyco Electronics full line of Raychem data bus products includes space-grade couplers, terminators, triaxial connectors, and SolderShield splices. These space-grade components meet the low outgassing requirements of NASA specification SP-R-0022A and can be used in outer-space applications.

Raychem space-grade components are designed in a variety of configurations and are currently available either as discrete items or as Raychem- assembled harnesses. Using factory-built harnesses eliminates unnecessary splices and connectors, reducing the cost and increasing the reliability of the networks. Specification control drawings describe the design

features and performance characteristics of Raychem space-grade couplers, terminators, connectors, and splices. The space-grade data bus couplers, terminators, and connectors have tin/nickel-plated metallic parts and baked silicone rubber components. For strain relief they include low-outgassing tubing. Unlike parts intended for aircraft applications, these components do not have polymeric environmental covers.

The table on the next page lists Raychem standard space-grade data bus components with their part numbers and descriptions. New components will become available per customer request.

Available in:	
Americas	■
Europe	■
Asia Pacific	■

Space-Grade Data Bus Components (Continued)

Series	Raychem
Space-grade data bus components	D-6022

Space-Grade In-Line Coupler
Part Numbering System

D-500-94 W W -X -YYY -ZZZ

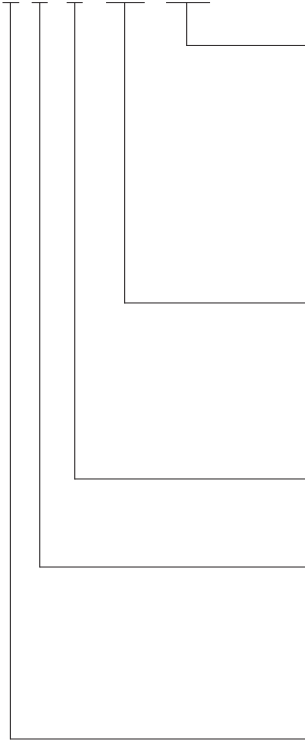

Cable Length

- 012 = 12 in
- 078 = 78 in
- 079 = 79 in
- 120 = 120 in
- 236 = 236 in
- 240 = 240 in
- 360 = 360 in

Cable Type

- S16 = 7724S1664 (24 AWG single optimized shield)
- S36 = 7724S3664 (24 AWG double optimized shield)
- S86 = 7724S8664 (24 AWG EMP hardened)
- H06 = 7742H0664 flat shield, unfilled (lightest cable)

Number of Stubs

- 1, 2, 3, or 4

Design

- 5 = Without internal terminator
- 6 = Same as 5 but with reverse bus
- 7 = With internal terminator
- 8 = Same as 7 but with reverse bus

Style

- 5 = Without mounting eyelet
- 6 = With mounting eyelet

DK-621 -09 XX -X X

Contact (installed, DK-621 kits only)

P = Pin*

S = Socket*

*May be ordered separately as D-602-0126 (pin) and D-602-0127 (socket)

Polarization (bayonet styles only) (jack view)

1 = A

2 = B

3 = C

4 = D



Basic Connector Configurations

Threaded styles:

11 = Plug

12 = Jack

Bayonet styles:

33 = Plug, A polarization

34 = Jack, A polarization

35 = Plug, B polarization

36 = Jack, B polarization

37 = Plug, C polarization

38 = Jack, C polarization

39 = Plug, D polarization

40 = Jack, D polarization

D-621 Connector, Kitted with Accessories

D-500-9463- ZZZ

Cable Type

612 = 10612 (24 AWG single optimized shield)

613 = 10613 (24 AWG double optimized shield)

614 = 10614 (24 AWG EMP hardened)

H06 = 7724H0664 flat shield, unfilled (lightest cable)





Customer-Specified Harness Assemblies and HarnWare Harness Design Software

Tyco Electronics supplies complete Raychem data bus networks in accordance with customer harness drawings, with any customer-specified cables and/or connectors. Using factory-built harnesses eliminates unnecessary splices and connectors, reducing the cost and increasing the reliability of the networks. Factory-built harnesses are pre-tested and ready for installation.

HarnWare Harness Design Software allows designers to draw a data bus harness in a matter of minutes, while selecting Raychem or others' components; a bill of materials is automatically generated.

Sample Drawing

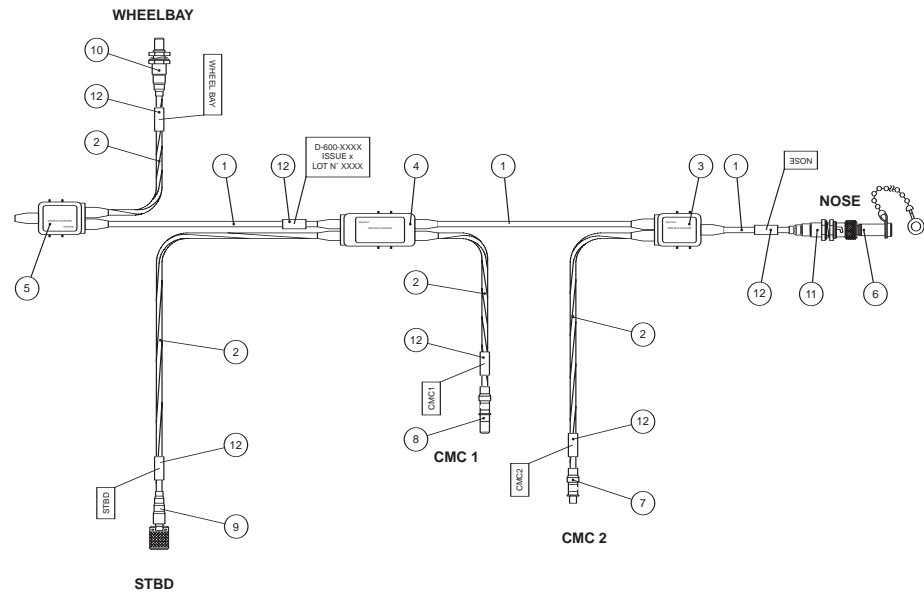

Parts List

Item	Description	Part No.	Spec/Remarks	Qty	Unit
1	Data bus Cable	10613-9	Raychem	5.3	M
2	Data bus Cable	10613-96	Raychem	7	M
3	Data bus Coupler	D-500-0455-1	Raychem	1	Pc
4	Data bus Coupler	D-500-0455-2	Raychem	1	Pc
5	Data bus Coupler	D-500-0457-1	Raychem	1	Pc
6	Data bus Terminator	D-621-0469-L	Raychem	1	Pc
7	Data bus Contact	DK-602-0156-N-2	Raychem	1	Pc
8	Data bus Contact	DK-602-0157-N-2	Raychem	1	Pc
9	Data bus Connector	DK-621-0411-P	Raychem	1	Pc
10	Data bus Connector	DK-621-0412-P	Raychem	1	Pc
11	Data bus Connector	DK-621-0434-1P	Raychem	1	Pc
12	Marker Sleeve	TMS-SCE-3/16-2.0-9	Raychem	6	Pc

Product Facts

- Superior EMC/EMI Shielding Performance
- Simple installation
- Easy reentry
- Simplified maintenance and repair
- Excellent mechanical and environmental resistance
- Efficient strain relief
- Flexibility
- Versatility

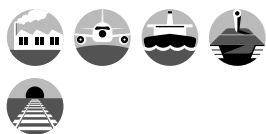

Available in:

- Americas ■
- Europe ■
- Asia Pacific ■

Introduction



Applications

Tyco Electronics, a longtime leader in harnessing technology, has written a new chapter in EMC shielding with the introduction of the Raychem HexaShield EMC adapter.

Designed to provide EMC protection solutions for both commercial and military applications, HexaShield adapters represent a significant improvement over pig-tail termination methods. By providing 360-degree EMC shielding on the termination area of each individual cable, HexaShield adapters provide outstanding shielding effectiveness.

HexaShield adapters are simple to install, easy to

maintain, and dependably resistant to mechanical and environmental stresses.

Principal points and features

- Easy reentry: To insert or remove ferrules from the HexaShield adapter, simply loosen the back nut.
- Superior protection: No degradation of shielding performance.
- Up to four shielded cables accommodated by each ferrule.
- Mechanical and environmental protection equal to backshells complying with MIL-C-85049 Category 3B.
- Strain relief on each individual cable.
- Weight reduction, by possibly eliminating the need for overall shielding.
- Compact size - not exceeding outer diameter of connector.
- Available in straight, 45° and 90° angles, as well as swept and long bodies.

Simple assembly and installation

1. Solder cable or wire shield to a ferrule with a Raychem heat-shrinkable SolderShield terminator.
2. Clip ferrule into one of the grounding star cavities.
3. Secure the back nut of the HexaShield adapter so that the conic ring assembly automatically compresses the ferrules.

Designed to corresponding connector specifications.

Installation Procedures

Two Platings Available	Raychem Product Specifications	
Electroless nickel (MIL-DTL-26074)	RB-110 and RB-114	
Olive drab cadmium (QQ-P-416 Type II Class 3)	—	
*Contact Tyco Electronics for additional platings.		
Installation procedure for HET-A-02X and HET-A-04X (RPIP-696-00)	Installation procedure for HET-03X (RPIP-696-03)	General procedure for cylindrical connectors, right-angle body (RPIP-696-07)
General procedure for ARINC 600 Size II connectors (RPIP-696-01)	General procedure for cylindrical connectors, straight body (RPIP-696-04)	—
General procedure for ARINC 600 Size III connectors (RPIP-696-02)	—	—

Hexashield Adapters for Circular Connectors: Straight, 45° and 90° Assemblies

Item	Description
1	Straight adapter assembly
2	Conic ring assembly
3	Star Plain (Standard) Drilled (Option) Split (Option) _
4	Straight adapter assembly - "L" version - nominally 0.5" [12.7] longer body
5	45° adapter assembly - welded
6	45° adapter assembly - swept
7	90° adapter assembly - welded
8	90° adapter assembly - swept Standard products shown. Variants available on request.
Split star assemblies are shown on relevant S.C.D's where applicable.	
Item	HexaShield Version
-1	Back Nut
-2	Tinel adapter assembly Tinel-Lock ring for single braid
-3	Bandstrap adapter assembly
-C	Conduit adapter

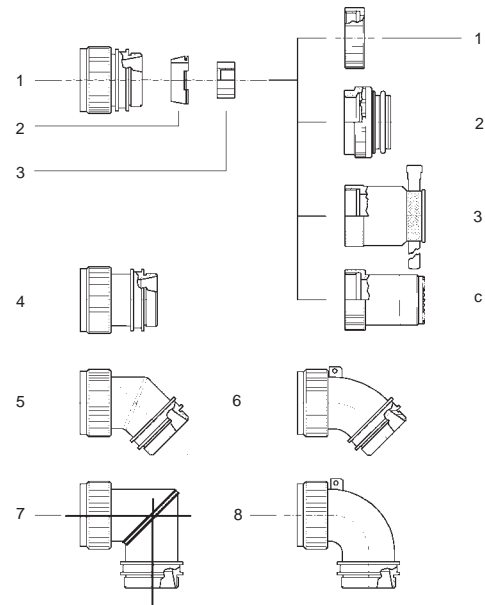

HexaShield Adapters for ARINC 404/600 Connectors: Sizes 1, 2, 3 and 4 Assemblies

Item	Description
1	Left side support
2	Right side support
3	Retention bars
4	Body assemblies Body Holding nut Conic ring assembly Star _ Back nut
5	Cavity plug assemblies Plug Holding nut
6	Pan head screws - 4-40 UNC
7	Spring washers

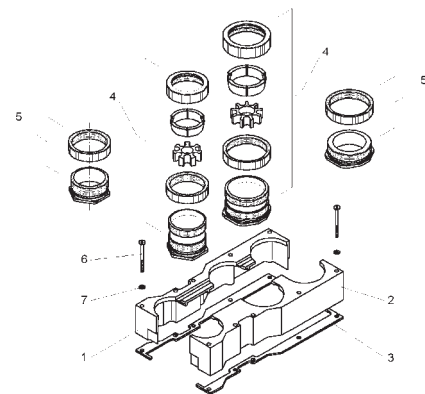

ARINC 600 Size 2 shown
Stars are available as plain, drilled or split.
See relevant S.C.D's for further information

Part Numbering for Standard Products

HexaShield Adapter for Circular Connectors

HEXYY L -AY -00 S -YY -AY -Y -DS

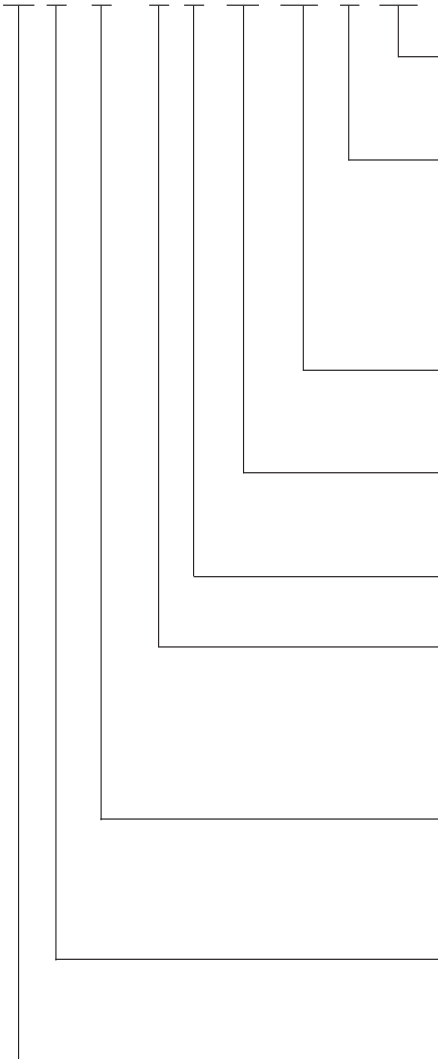

Drilled Star:

See applicable SCD for star options

Type of Back Nut:

- 1 = Standard back nut
- 2 = Clamping nut for tincl ring (for overbraid protection)
- 3 = Clamping nut with bandstrap
- C = Clamping nut for conduit applicator

Max. number of ferrules that can be accommodated
See applicable SCD for options

Hexashield Size Code:

See applicable SCD for order number (shell size)

S = Swept version

Configuration:

- 00 = Straight body
- 45 = 45 degree angle body
- 90 = 90 degree angle body

Type of Plating:

- B = Cadmium plated
- C = Electroless nickel

L = Long body
See applicable SCD for availability

Connector Code Number:

- 21 = MIL-C-26482 Series 1
- 40 = MIL-DTL-38999 Series 3 and 4
- 41 = MIL-DTL-38999 Series 1 and 2
- 54 = MIL-DTL-38723 Series 1 and 3
- MIL-C-25482 Series 2



Ordering Information (Continued)

HexaShield Adapter for Collins Connectors

HEXDB-AC-00-A9-1

00 = Straight body
90 = Right-angle body

HexaShield Adapter for ARINC 600 Connectors

HEXA6-AY-00-YY-AY-Y

Clamping nut version:

1 = Clamping nut alone
2 = Clamping nut for tincl ring

Number of ferrules:

18 for ARINC 600 size II (A and B cavities)
25 for ARINC 600 size II (A, B and C cavities)
18 for ARINC 600 size III (A and B cavities)
See applicable SCD for options

ARINC Connector Size:

02 = ARINC 600 size II
03 = ARINC 600 size III

Configuration:

00 = Straight body
90 = Right-angle body

Plating:

B = Cadmium plated
C = Electroless nickel

Drilled Stars are standard on ARINC 600 adapters.

Part Numbering of Ferrule Kits*

HET-A-02X for small-size cable with SolderShield terminator

HET-A-03X for connection of unshielded cables
ferrules with heat-shrinkable tubing (no shield)

HET-A-04X for large-size cables with SolderShield terminator

Type of Plating:

B = Cadmium plated
C = Electroless nickel

HEX07-AX ferrule - solid blank for use when a HET-A is not needed

Type of Plating:

B = Cadmium plated
C = Electroless nickel

*Not all part numbers are standard; your local Tyco Electronics representative will assist you in selecting the appropriate standard product

Product Facts

- Outperforms traditional pigtail termination, especially in HIRF performance
- Withstands 10-kA peak current lightning transients of SAE AE4L-87-3

EMC Performance

Transfer Impedance

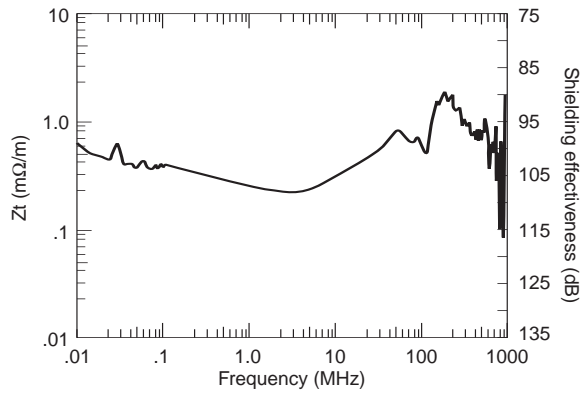

HexaShield size: 23
 Cable: Raychem 5024H8424 (one cable installed)
 Test method: CEI 96-1

Protection Level

Generalized system performance (Actual system performance in any one test method may differ.)

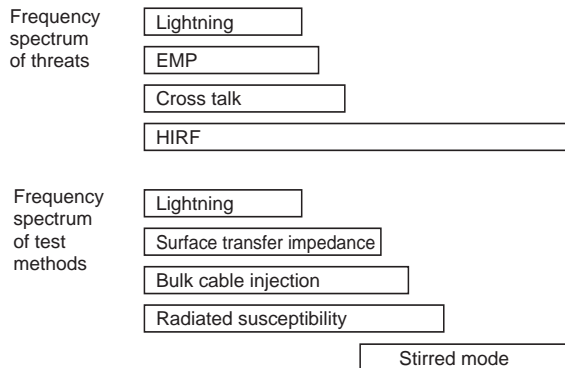
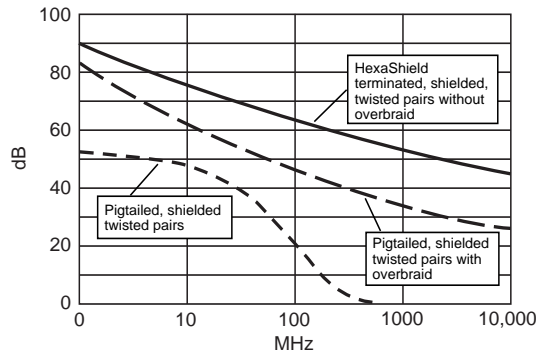

8 Electrical Interconnect Products

Typical HexaShield Applications**EMC Performance (Continued)**

Civilian and military aircraft
Avionics
Fighter aircraft
Missiles and launch support systems
Armored and military support vehicles
Navy ships (total shipboard hardening)
Military communications
Engines (FADEC harness hardening)

HexaShield Product Range

Accommodates the following connector types*:
MIL-C-26482 Series 1
MIL-DTL-38999 Series 1, 2, 3, and 4
MIL-C-26482 Series 2
MIL-DTL-83723 Series 1 and 3
DBAD
ARINC 600
ARINC 404

*Please contact Tyco Electronics for other connector types and special requests.

Introduction

Product Facts

- Low-profile rectangular design for high packaging density
- Environmental sealing for aerospace applications
- Modular components for design versatility and logistics savings
- Lightweight materials for weight savings
- Quick-disconnect mating hardware

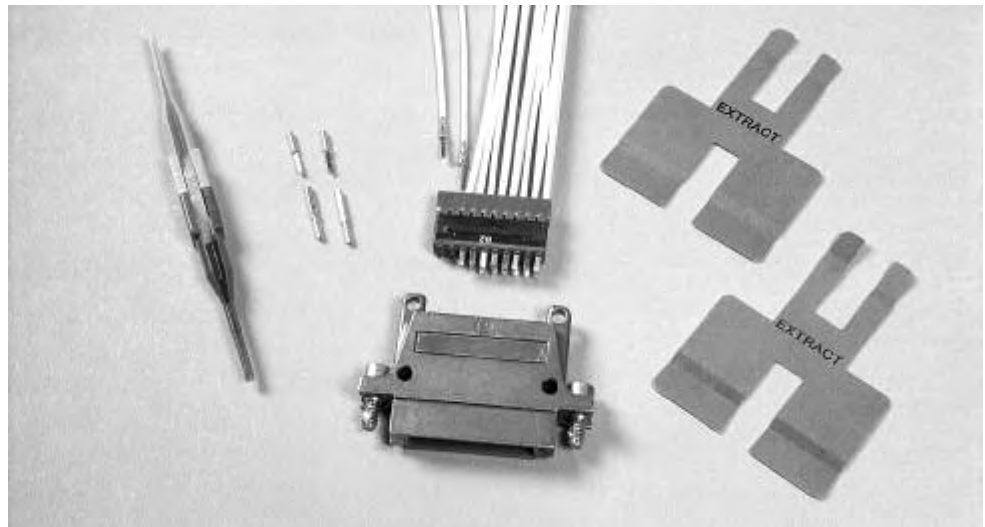

System

The Raychem MTC product line is a complete modular connector system consisting of lightweight, environmentally sealed miniature rectangular connectors (shell housings with removable inserts) and individually removable rear-release contacts.

Components

MTC connectors are now available with quick-disconnect mating hardware, EME shielding accessories, and modular inserts that can accommodate a mix of signal and power crimp contacts and coaxial contacts. The need for special termination tooling has

been minimized, while the ease of manufacturing and maintenance has been improved.

Configurations

MTC rectangular connectors using jack screws or quick-disconnect hardware can be stacked or panel-mounted next to each other without any provision for grip space, a feature that can save significant panel area.

MTC connectors are available in 1-inch and 2-inch configurations. Modular removable inserts with size 22 and/or size 16 contact cavities can be combined into the 1-inch and 2-inch MTC housings.

Inserts

MTC inserts are available in 20-cavity and 5-cavity versions. The 20-cavity insert accepts size 20-22 (24 AWG to 20 AWG wire) crimp contacts. The 5-cavity insert accepts size 16-14 crimp contacts. Insertion/extraction of the contacts is rear release.

Note:
Other configurations are available in the MTC family (size 12 contacts; 50 mil spacing for double density; accessories). Please contact Tyco Electronics.

Available in:	
Americas	■
Europe	■
Asia Pacific	■



20-Cavity Inserts

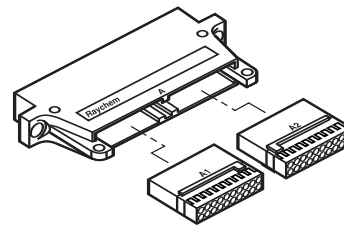

2-inch shell with inserts

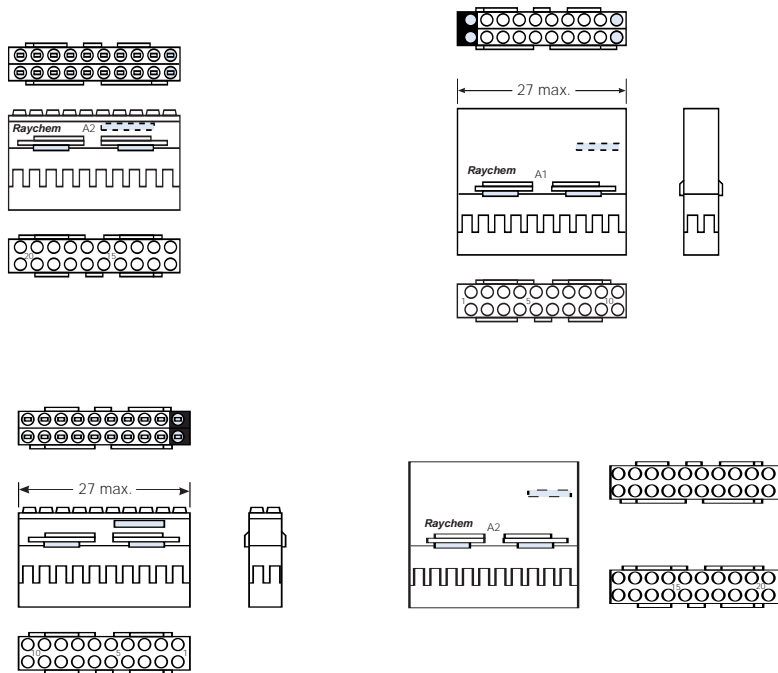

MTCP-122-20 inserts are used with MTC100 1-inch and 2-inch shells. The 1-inch shell takes:

- One MTCP-122-20P (pin contact) or
- One MTCP-122-20S (socket contact)

The 2-inch shell takes:

- One MTCP-122-20P1 and one MTCP-122-20P2 (pin contact) or
- One MTCP-122-20S1 and one MTCP-122-20S2 (socket contact)

2 x 20 Cavity Inserts
(Size 20-22)—2-Inch Shell

Pin Insert	Socket Insert
MTCP-122-20P1	MTCP-122-20S1
MTCP-122-20P2	MTCP-122-20S2

1 x 20 Cavity Inserts (Size 20-22)—1-Inch Shell

20-Cavity Inserts (Continued)

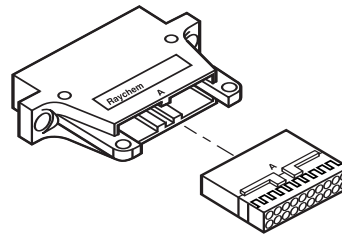

1-inch shell with insert

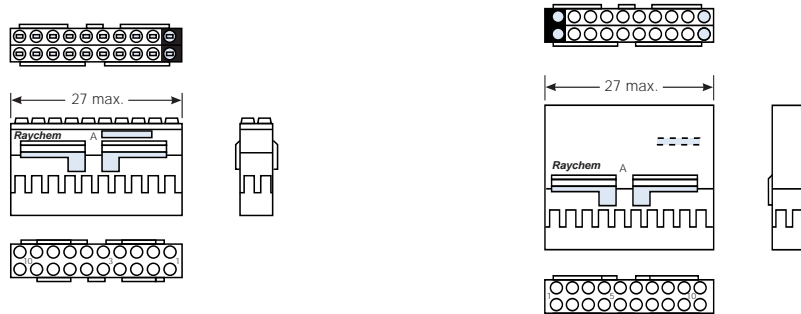

Pin Insert	Socket Insert
MTCP-122-20P	MTCP-122-20S

Contacts for 20-Cavity Inserts

The contacts for 20-cavity inserts must be ordered separately. They are:

- CTA-0166—pin contact
- CTA-0165—socket contact

Contacts accept 24 AWG to 20 AWG wires.



Pin Contact
CTA-0166



Socket Contact
CTA-0165

Tools		Tools	
Positioner for pin contact	CE-1605900	Positioner for socket contact	CE-1606000
Installation process	ES-61413	Installation process	ES-61413
Contact removal tool (plastic)	CTA-1160	Contact removal tool (plastic)	CTA-1160
Extraction tool for MTCP inserts	CTA-0161	Extraction tool for MTCP inserts	CTA-0161

5-Cavity Inserts

5-Cavity Inserts (Size 16)

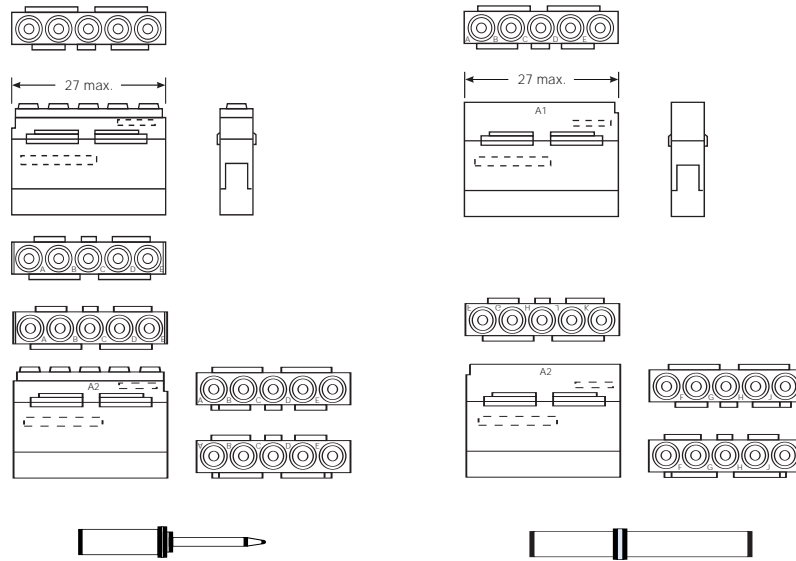

MTCP-116-05 inserts are used with MTC100 1-inch and 2-inch shells.
The 1-inch shell takes:

- One MTCP-116-05-P1 (pin contact) **or**
- One MTCP-116-05-S1 (socket contact)

The 2-inch shell takes:

- One MTCP-116-05P1 and one MTC-116-05P2 (pin contact) **or**
- One MTCP-116-05-S1 and one MTCP-116-05-S2 (socket contact)

5-Cavity Inserts (Size 16)

Pin Insert	Socket Insert
MTCP-116-05P1	MTCP-116-05S1
MTCP-116-05P2	MTCP-116-05S2

Contacts for 5-Cavity Inserts

The contacts for 5-cavity inserts must be ordered separately. They include:

- CTA-0079 - pin contact (MS 27493-16) (MIL-C-39029/58 intermateable)
- CTA-0078 - socket contact (MS 27491-16) (MIL-C-39029/57 intermateable)
- D-602-0140 - coaxial pin contact (MIL-C-39029/76 intermateable)
- D-602-0171 - coaxial socket contact (MIL-C-39029/78 intermateable)

Other contacts designed for M38999 Series II connectors can be used.

Pin Contact	Socket Contact
D-602-0140 (coaxial)	D-602-0171 (coaxial)
CTA-0079 (power)	CTA-0078 (power)



Hybrid Inserts

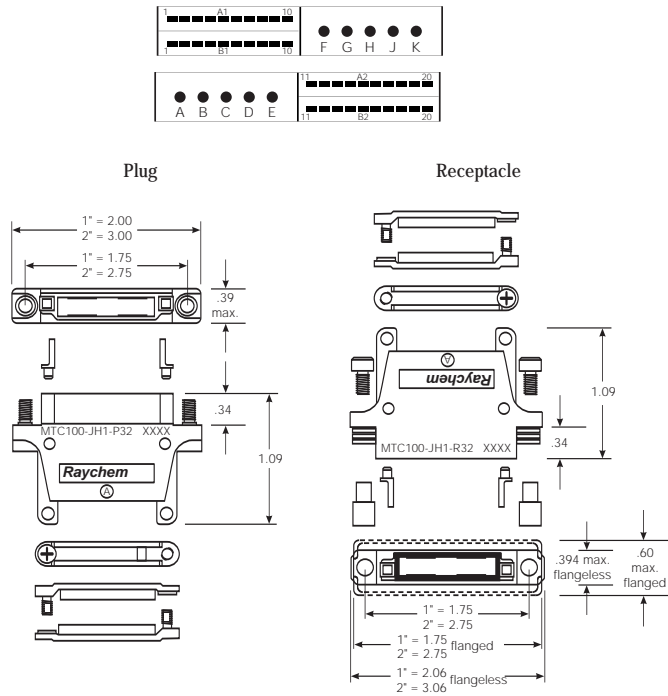

Hybrids

Hybrid insert combinations of size 22 and size 16 contact cavities are also possible.

2-Inch Shell—Hybrid Assembly

Power and signal

Shells

MTC connector housing shells are available with nickel plating (48-hr salt spray performance) or cadmium over nickel plating (500-hr salt spray performance).

MTC connector housings are offered with quick-disconnect or jack-screw mating hardware. Each connector shell is polarized and has 64 user-defined keying combinations. Lightweight, low-profile EME backshells are also available for increased shielding effectiveness of the connector.

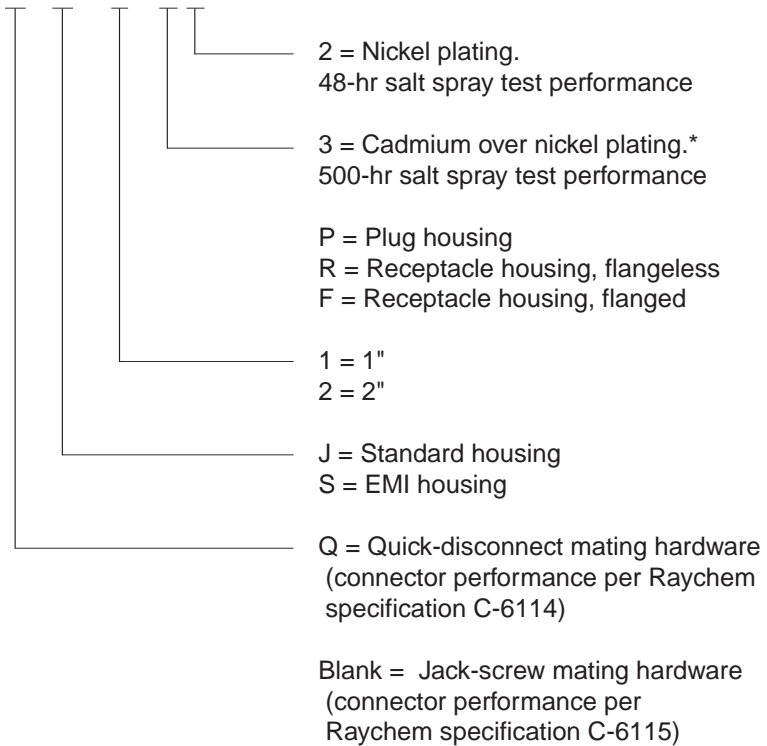

MTC Shells Ordering Information**M T C 1 0 0 X - X H X - X X 2**

*Some combinations of shells, mating hardware and EME shielding accessories are not available.
Contact Tyco Electronics for product information.

Accessories



Low-Profile EME Backshells

Lightweight rectangular EME backshells connect the overall bundle shield to the MTC connector housing. Individual cable shields can also be terminated to the backshell braid by using Raychem SolderSleeve devices.

The backshell is mounted on the MTC housing via the cable clamp screws.

MTC backshell features include a low profile, light weight, and Level II EME performance.

EME Backshell Adapters

- CHA-0275 2-inch adapter (plug or receptacle)
- CHA-0276 1-inch adapter (plug or receptacle)



MTC Shield-Grounding BusBars

Raychem MTC shield-grounding busbars allow for simple, cost-effective termination of cable shielding to MTC aluminum housings.

Two-inch shield-grounding busbars terminate up to 20 shielded twisted pairs on a 2-inch MTC connector. The individual shields are terminated to "fingers" on the busbar with Raychem SolderSleeve devices.

The busbar is mounted on the MTC housing via cable clamp screws.

MTC busbar features include a simple termination, cost effectiveness, light weight, and Level I EME performance.

Shield-Grounding Busbars

- CTA-0022 1-inch busbar (with 5 SolderSleeve terminators)
- CTA-0023 2-inch busbar (with 10 SolderSleeve terminators)

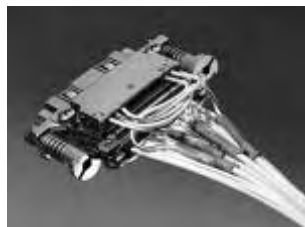

EME Shielding Accessories for MTC Connectors

Grounding Block

Allows for cable shield termination grounding on the MTC shell housing via crimp-removable contacts. This grounding scheme allows individual cables to be removed from the connector without cutting a ganged ground connection. Sufficient ground contacts are available to handle shielded twisted-pair cables.

Grounding Block

- CHA-0301 1-inch grounding block receptacle shell
- CHA-0302 2-inch grounding block receptacle shell
- CHA-0303 1-inch grounding block plug shell
- CHA-0304 2-inch grounding block plug shell



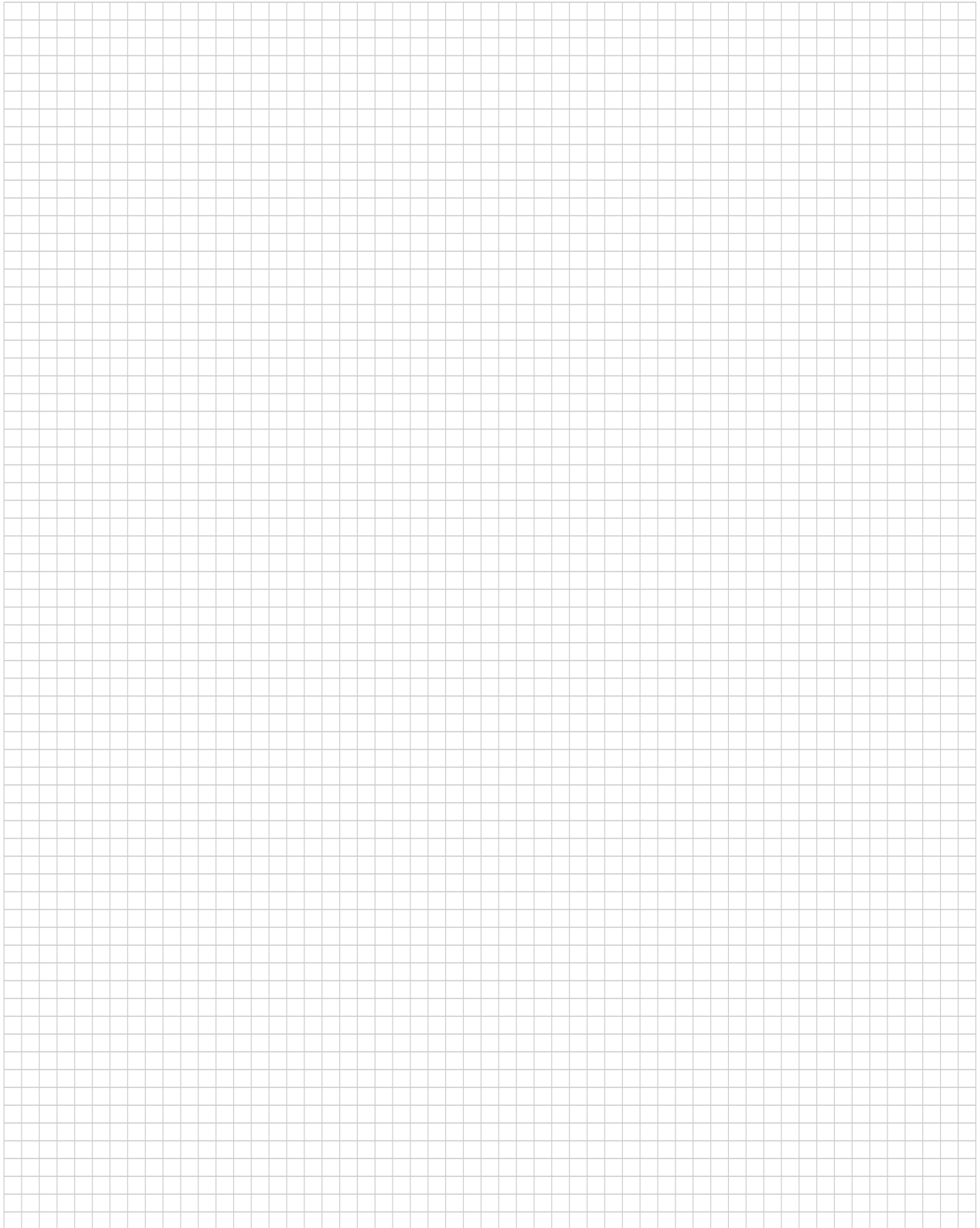

Table of Contents

Introduction 9-2

High-Performance Wire and Cable

 SPEC 44 9-3 to 9-9

 SPEC 55 9-10 to 9-18

 RCW 9-19 to 9-24

 FlexLine (SPEC 80) 9-25, 9-26

Low-Fire-Hazard Wire and Cable

 FR-1000 9-27 to 9-34

 Type 99M 9-35 to 9-38

 Zerohal 100A 9-39 to 9-41

 Zerohal 100G 9-42 to 9-44

Commercial Wire Family

 FlexLite 9-45, 9-46

 FlexLite DW 9-47, 9-48

 FlexLite TW 9-49, 9-50

 FlexLite MT 9-51, 9-52

 FlexLite HT 9-53, 9-54

 FlexLite TX 9-55, 9-56

 FLT 9-57 to 9-59

Thermocouple Extension Cable

 Thermocouple Extension Cable 9-60 to 9-62

Controlled Electrical Cables

 Electroloss FilterLine 9-63 to 9-67

 Cheminax Coaxial Cables 9-68 to 9-70

 Cheminax High-Performance Cables 9-71, 9-72

 Cheminax Twin Axial Cables 9-73, 9-74

Multiconductor (Multicore) Cables

 Custom Designed and Standard Multiconductor Cables 9-75

 Multicore Cables 9-76

Cable Jacket Materials

 Properties and Specifications 9-77, 9-78

 FDR 25 9-79, 9-80

 Zerohal 9-81 to 9-83

 Thermorad HTF/Fluoroelastomer 9-84

 Thermorad/Thermorad F 9-85

 Raythane, Neoprene, Rayolin, and AFR 9-86

Miscellaneous

 Electrical Shielding 9-87, 9-88

 Computer-Aided Design 9-89

 Power Cables 9-90 to 9-93

 Conductor Sizes, Strandings, and Resistance Values 9-94, 9-95

 Fiber Optic Cables 9-96 to 9-99

Note: Users should independently evaluate the suitability of the product for their application. Before ordering, check with Tyco Electronics for most current data.

Introduction

Tyco Electronics provides wire and cable solutions for challenging environments and demanding applications. The Raychem product range includes high-performance insulated wires, coaxial and data bus cables, power cables, electronics wire, and multicore cables.

- SPEC 44 wire is an economical yet rugged dual-wall insulation system rated at 150°C [221°F], with consistently low cost and reliable performance.
- SPEC 55 wire insulation provides high reliability in harsh environments from -65°C to +200°C [-85°F to +392°F]. Resistant to electrical arc tracking, it combines the easy handling of a flexible wire with excellent resistance to scrapes, abrasion, and cut-through.
- RCW is a small size, ultra light weight insulated wire with a temperature rating of -65°C to +260°C [-85°F to +500°F]. It is resistant to electrical arc tracking in wet or dry conditions and has excellent cut-through resistance.
- Type 99T dual-wall insulation system is a 105°C [221°F] rated wire that combines excellent chemical and mechanical resistance with limited fire hazard performance.
- ElectroLoss Filterline wire reduces the vulnerability of critical circuits to high-frequency electromagnetic interference.
- Cheminax coaxial and data bus cables allow system designers to optimize minimum size and weight with impedance and attenuation characteristics.
- Multiconductor (multicore) cables organize a variety of Raychem wire and cable products in controlled geometries for specific applications. Using a computer-aided design system, Tyco Electronics can quickly design multicore cables to meet your needs. A variety of cable jackets are available to suit most applications.

Raychem wire and cable products can meet your specific application needs. Here are just a few examples:

- Limited-fire-hazard wire and cable for mass transit and marine applications.
- High-performance, high temperature automotive wiring.
- Small, light hookup wires for high-temperature applications in commercial appliances, tools, and devices.
- Very flexible, rugged, thin-wall insulated power cables.
- Low-outgassing space-vehicle wiring.
- Lightweight, shielded wire and cable constructions for aerospace applications.
- Thermocouple extension cables with a range of our high-performance insulations materials.

Contact Tyco Electronics to find out more about wire and cable and our associated interconnection products.

SPEC 44

Product Facts

- Dual wall construction
- 600, 1000 and 2500 voltage rating
- Small size, light weight
- Low smoke and low corrosive gas generation
- Resistant to most chemicals and electrical arc tracking



Applications

SPEC 44 wire has a dual wall construction which combines the outstanding physical and electrical characteristics of radiation crosslinked polyalkene with the excellent mechanical and chemical properties of radiation cross-linked polyvinylidene fluoride (PVDF).

The result is a wire insulation system that offers a 150°C [302°F] temperature rating, small size, light weight, solder iron resistance, and resistance to most solvents, fuels and lubricants.

SPEC 44 wire and cable is highly flame retardant, non-melting, does not cold flow,

and though mechanically very tough, is easy to handle and install using conventional tools.

Originally developed for aerospace and military requirements in applications of high density and complex circuitry, SPEC 44 wire and cable now finds wide use throughout industry, in commercial and military electronics, avionics, on satellites, aircraft, helicopters, ships, trains, and offshore platforms where environmental conditions demand consistently reliable performance. In air-frame applications SPEC 44 constructions can offer a modern dimensional

replacement for PVC/Nylon/ Glass braid type wire and cables. SPEC 44 wire is offered in a wide range of sizes in stranded conductors, standard materials available being tin or silver-plated copper and high strength copper alloy. Voltage ratings of 600, 1000 and 2500 volts are available as standard. Shielded and jacketed versions include single and multi-conductor constructions and flat braid shields where further size and weight savings are achieved.

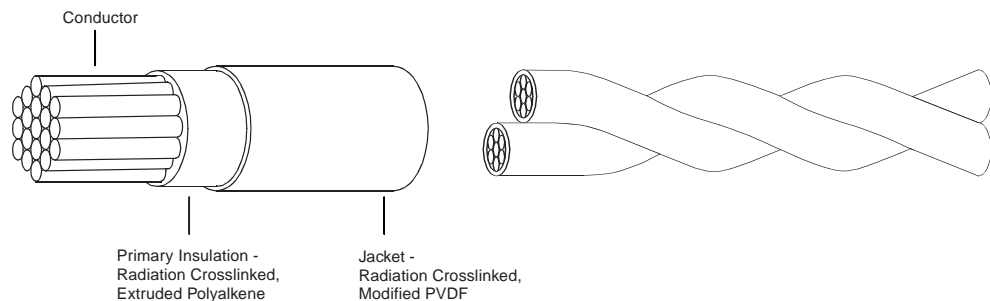

Available in:	Americas	Europe	Asia Pacific
	■	■	■

SPEC 44 (Continued)

Physical Characteristics

Small Size

SPEC 44 equipment wire, 600 volt rated has a 0.19 [.008] nominal wall thickness compared to 0.25 [.010] and 0.38 [.015] for equivalent PTFE and PVC wires in MIL-W-16878, MIL-W-22759 or BS G210.

Light Weight

Because of the thin wall and low density of the insulation materials considerable weight savings are made over similarly rated PTFE wires, eg:- 44A0111-22AWG equipment wire 4.62 grams/meter max
22 AWG PTFE equipment wire, MIL-W-81044 5.54 grams/meter max

General Handling

The flexibility of SPEC 44 and the ease with which it takes a 'set' makes it one of the easiest of the 'high performance' wires to install. Stripping is done with conventional die blade strippers.

For details of appropriate tools see separate wire handling guide. The tin-plated conductor usually specified is easily soldered or crimped. The insulation may be hot stamp marked or printed and does not need etching before potting.

Lengths

SPEC 44 is available in long continuous lengths and can be supplied for use on automatic cut and strip wire preparation machines.

Specifications/Approvals

MIL-W-81044, NEMA-WC-27500 (Cables)

Def Stan. 61-12 Part 18 Issue 4 - Type 1 pliable (Maintenance Range)

Def Stan. 61-12 Part 26 Issue 3 Type 2, 3, 8 & 9 & METS

VG 95218 Parts 20, 21, 22, 23 and 1000

NATO Stock Numbers (NSN's) exist for most standard constructions

Civil Aviation Authority Accessory Approval E11623

Lloyds Register of Shipping

NASA Preferred Product List

Raychem Specification 44

Typical Properties

Temperature rating	-65°C to +150°C [-85°F to +302°F]
Voltage rating (thin wall)	600 V
Voltage rating (thick wall)	2500 V
Tensile strength and elongation of insulation	28 N/mm ² , 230%, 4000 PSI
Notch propagation, 0.05mm notch	Pass
Solder iron resistance (370°C, 1 minute)	Pass
Shrinkage, 200°C	<1%
Low temperature bend	-65°C [-85°F]
Voltage withstand (thin wall)	2500 V
Resistance: fuels, oils, solvents	Pass

SPEC 44 (Continued)

Environmental Performance

Temperature Rating

SPEC 44 wire and cable is rated for continuous operation from -65°C to +150°C [-85°F to +302°F] and for short periods at temperatures as high as 300°C [572°F]. Heat ageing tests are routinely performed at temperatures of 200°C [392°F] (168 h) and 300°C [572°F] (6 h). In addition SPEC 44 insulation will not shrink back under repeated cycling.

Mechanical Performance

SPEC 44 wire provides better cut through resistance than some wires with much thicker walls. 600 volt equipment wire 44A0111 (0.19 mm wall) has 40% greater cut through resistance than 600 volt PTFE insulated wire (0.25 mm wall).

Solder Iron/Overload Resistance

The radiation crosslinking of the materials used in SPEC 44 makes them non-melting at high temperature. As a result SPEC 44 wire is resistant to prolonged contact with solder irons and is resistant to current overloads which would melt most thermoplastic insulations.

Chemical Resistance

The irradiated dual wall construction of SPEC 44 wire is highly resistant to many acids, alkalis, hydrocarbon solvents, fuels, lubricants, water, and many missile fuels and oxidizers.

Cold Flow

Radiation cross-linking of SPEC 44 prevents cold flow of the insulation — a recognized problem of some uncrosslinked materials.

Voltage Ratings

Standard available voltage ratings for SPEC 44 wire are 600 volts (0.19 mm wall thickness), 1000 volts (0.28 mm wall) and 2500 volts (0.48 mm wall).

Electrical Arc Track Resistance

SPEC 44 insulation demonstrates a total resistance to arc tracking under both wet and dry conditions at aircraft system voltages.

Low Outgassing

For use in space applications, special constructions of SPEC 44 wire are available with low outgassing characteristics, for use in an environment of high vacuum and high temperature.

Fire Hazard Performance

Flammability	Federal Aviation Reg FAR-25	Pass
	BS4066 vertical flammability	Pass
	S424 14751 (Swedish chimney)	Pass
	NFC 32070 (2) (French chimney)	Pass
	IEC 332 part 3 (Cable ladder)	Pass
Smoke/Toxicity Index	Smoke Index, Def Stan 61-12 (18)	6 per meter of wire
	Toxicity Index, Def Stan 61-12 (18)	0.8 per meter of wire
	Oxygen Index, NES 714	30% Oxygen
	Temperature Index, NES 715	>300°C [572°F]

Part Numbering System

44 X X X X X- AWG- X/X- X

Basic Product Number

Temperature Rating:

- / - 135°C (XL-PVF2 cable jacket)
- A - 150°C (XL-PVF2 cable jacket)
- AC - 150°C (same as 44AM with 90% min. shield coverage)
- AM - 150°C (M27500, shielded and/or XL-PVF2 jacketed cable)
- B - 150°C (XL-ETFE cable jacket)

Construction

- 0 - Primary wire; or unshielded & unjacketed cable
- 1 - Round braid shielded and jacketed cable**
- 2 - Tin-coated copper flat braid shielded & jacketed cable
- 3 - Round braid shielded cable, no jacket**
- 4 - Jacketed cable, no shield
- 5 - Spiral braid shielded & jacketed cable**
- 7-9 - Special constructions

Class of Wire

- 1 - 600 V, general purpose
- 2 - 1000 V, general purpose
- 3 - 2500 V, general purpose
- 4 - 600 V, outerspace*
- 5 - 1000 V, outerspace*
- 6 - 2500 V, outerspace*
- 7 - 600 V, airframe
- 8 - 600 V, medium weight

Number of Conductors

1 through 10 (designator for 10 conductor = 0)

Conductor Type

- 1 - Tin-coated copper
- 2 - Silver-coated copper
- 3 - Nickel-coated copper
- 4 - Silver-coated high strength copper alloy
- 5 - Aluminum
- 6 - Nickel-coated high strength copper alloy
- A - Silver-coated CS95
- C - Silver-coated high strength copper alloy (cadmium-free)
- D - Nickel-coated high strength copper alloy (cadmium-free)

Conductor Size (AWG)

Primary Wire Insulation Color

(code per MIL-STD-681)

- 0 - Black
- 1 - Brown
- 2 - Red
- 3 - Orange
- 4 - Yellow
- 5 - Green
- 6 - Blue
- 7 - Violet
- 8 - Gray
- 9 - White

Jacket Color

(codes same as for Primary Wire Insulation Color)

* Classes 4, 5 and 6 available only as "44/" constructions. 44/7xxx and 44A7xxx will be available as indicated on the applicable SCD.
 **Shield coating same as conductor coating except: - for Conductor Type 4, 6, C and D, shield shall be tin-coated copper

Typical ordering example	3 conductors, brown, yellow with green stripe, blue, white jacket. If 600 volt, round braid, 20 AWG tinned conductor, 44A1131-20-1/45/6-9.
Ordering information	Other constructions and custom designed wire and cable are available on request.

NEMA WC-27500 Cable
Part Numbering System

M27500 X AWG XX X X XX

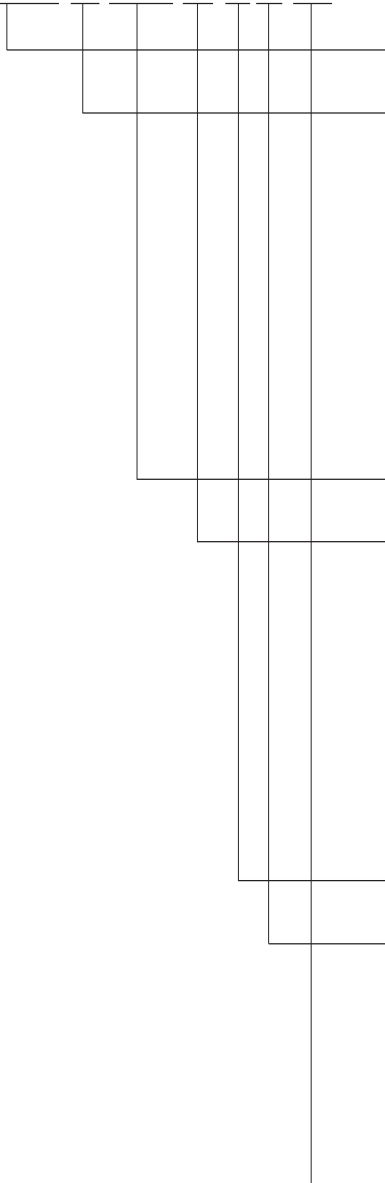

Basic Specification Number

Component Wire ID/Shield Coverage Code

Shield Coverage

85%	90%
-	C
A	D
B	E
F	H
G	J
K	M
L	N
P	R
S	T

Component Wire Identification

- Colored Stripes on White Wire (9/96/93/95/92/90/94/97/98/91... etc.)
- Solid Color Wires (9/6/3/5/2/0/4/7/8/1...etc.)
- Band Marks on Solid Colors (by AWG)
- Alternate Colored Stripes (92/96/94/95/9/90/91/93/97/98...etc)
- Alternate Solid Colors (2/6/4/5/9/0/1/3/7/8...etc.)
- Number Marking on Solid Colors (by AWG)
- Number Marking on White Wires
- Band Marks on Colored Stripes (by AWG)
- Band Marks on White Wires

Conductor Size (AWG)

Basic Wire Spec Code (MIL-W-81044) and Slash Sheet

- MD - M81044/5 (44A0712)
- ME - M81044/6 (44A0711)
- MF - M81044/7 (44A0714)
- MG - M81044/8 (44A0812)
- MH - M81044/9 (44A0811)
- MJ - M81044/10 (44A0814)
- MK - M81044/11 (44A0112)
- ML - M81044/12 (44A0111)
- MM - M81044/13 (44A0114)

Number of Component Wires

Shield Material and Style Code

- U - No shield
- T - Tin-coated copper, round
- J - Tin-coated copper, flat
- S - Silver-coated copper, round
- G - Silver-coated copper, flat
- N - Nickel-coated copper, round

Jacket Material and Style Code

- 00 - No jacket
- 08 - Crosslinked, white PVDF
- 23 - Crosslinked, white Modified ETFE

Example: **M27500-22ML3T08 = 44AM1131-22-9/96/93-9**

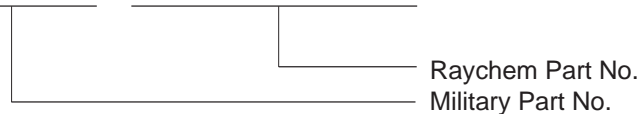

SPEC 44 (Continued)

Primary Wires/Twisted Pair



44A011X (600 V)
Primary Wire

44A021X (1000 V)
Primary Wire

Wire Size (AWG)	Stranding		CSA (mm ²)	44A011X (600 V)		44A021X (1000 V)	
	(mm)	#/AWG		Nom. OD	Max. Weight (g/m) lb/kft	Nom. OD	Max. Weight (g/m) lb/kft
30	7/0.10	7/38	0.06	0.68 [0.027]	1.06 [0.71]	—	—
28	7/0.13	7/36	0.09	0.76 [0.030]	1.43 [0.96]	—	—
26*	19/0.10	19/38	0.15	0.86 [0.034]	2.08 [1.4]	1.02 [0.040]	2.38 [1.6]
24	19/0.13	19/36	0.25	1.02 [0.040]	2.98 [2.0]	1.17 [0.046]	3.57 [2.4]
22	19/0.16	19/34	0.40	1.19 [0.047]	4.46 [3.0]	1.37 [0.054]	5.20 [3.5]
20	19/0.20	19/32	0.60	1.40 [0.055]	6.70 [4.5]	1.57 [0.062]	7.59 [5.1]
18	19/0.25	19/30	1.00	1.65 [0.065]	10.12 [6.8]	1.85 [0.073]	11.46 [7.7]
16	19/0.29	19/29	1.25	1.83 [0.072]	12.80 [8.6]	2.06 [0.081]	14.58 [9.8]
14	19/0.36	19/27	2.00	2.26 [0.089]	19.64 [13.2]	2.49 [0.098]	21.88 [14.7]
12	37/0.32	37/28	3.00	2.74 [0.108]	30.06 [20.0]	2.97 [0.117]	32.89 [22.1]
10	37/0.40	37/26	5.00	3.28 [0.129]	46.28 [31.1]	3.71 [0.146]	52.98 [35.6]
8	133/0.29	133/29	—	—	—	5.23 [0.206]	91.97 [61.8]

*For 44A0211-26 the stranding is 7/0.16mm 7/34 AWG



44A031X (2500 V)
Primary Wire

44A081X (600 V)
Airframe Wire

44A012X (600 V)
Twisted Pair

44A031X (2500 V)		44A081X (600 V)		44A012X (1000 V)	
Nom. OD	Max. Weight (g/m) lb/kft	Nom. OD	Max. Weight (g/m) lb/kft	Nom. OD	Max. Weight (g/m) lb/kft
—	—	—	—	1.37 [0.054]	2.38 [1.6]
—	—	—	—	1.52 [0.060]	3.13 [2.1]
1.35 [0.053]	3.13 [2.1]	1.22 [0.048]	2.98 [2.0]	1.73 [0.068]	4.47 [3.0]
1.44 [0.057]	4.46 [3.0]	1.37 [0.054]	3.87 [2.6]	2.03 [0.080]	6.69 [4.5]
1.75 [0.069]	6.40 [4.3]	1.57 [0.062]	5.65 [3.8]	2.38 [0.094]	9.82 [6.6]
1.98 [0.078]	9.08 [6.1]	1.78 [0.070]	8.04 [5.4]	2.79 [0.110]	14.73 [9.9]
2.23 [0.088]	12.95 [8.7]	2.03 [0.080]	11.91 [8.0]	3.30 [0.130]	22.32 [15.0]
2.46 [0.097]	16.22 [10.9]	2.26 [0.089]	14.73 [9.9]	3.65 [0.144]	28.42 [19.1]
2.92 [0.115]	24.10 [16.2]	2.74 [0.108]	22.17 [14.9]	4.52 [0.178]	44.35 [29.8]
3.32 [0.131]	36.01 [24.2]	3.20 [0.126]	32.59 [21.9]	5.48 [0.216]	69.00 [46.5]
4.09 [0.161]	54.32 [36.5]	3.94 [0.155]	52.08 [35.0]	—	—
96.20 [0.219]	96.73 [65.0]	92.94 [0.214]	93.46 [62.8]	—	—

Shielded and Jacketed Cable

SPEC 44 (Continued)



44A111X (600 V)
1 Conductor



44A121X (600 V)
1 Conductor

Wire Size (AWG)	Stranding		44A111X (600 V)		44A121X (600 V)	
	(mm)	#/AWG	Nom. OD	Max. Weight (g/m) lb/kft	Nom. OD	Max. Weight (g/m) lb/kft
30	7/0.10	7/38	1.47 [0.058]	5.20 [3.5]	—	—
28	7/0.13	7/36	1.55 [0.061]	5.80 [3.9]	1.60 [0.063]	5.65 [3.8]
26	19/0.10	19/38	1.57 [0.065]	6.84 [4.6]	1.73 [0.068]	6.85 [4.6]
24	19/0.13	19/36	1.83 [0.072]	8.63 [5.8]	1.98 [0.078]	9.67 [6.5]
22	19/0.16	19/34	2.01 [0.079]	10.71 [7.2]	2.24 [0.088]	12.35 [8.3]
20	19/0.20	19/32	2.26 [0.089]	14.73 [9.9]	2.54 [0.100]	17.41 [11.7]
18	19/0.25	19/30	2.62 [0.103]	20.68 [13.9]	2.82 [0.111]	22.62 [15.2]
16	19/0.29	19/29	2.79 [0.110]	24.55 [16.5]	3.02 [0.119]	26.64 [17.9]
14	19/0.36	19/27	3.22 [0.127]	34.08 [22.9]	3.45 [0.136]	36.16 [24.3]
12	37/0.32	37/28	3.70 [0.146]	47.77 [32.1]	4.14 [0.155]	49.56 [33.3]

Other sizes are also available in some constructions depending on conductor type and construction required.



44A181X (600 V)
1 Conductor



44A112X (600 V)
2 Conductor

Wire Size (AWG)	44A181X (600 V)		44A112X (600 V)	
	Nom. OD	Max. Weight (g/m) lb/kft	Nom. OD	Max. Weight (g/m) lb/kft
30	—	—	2.23 [0.088]	8.63 [5.8]
28	—	—	2.38 [0.094]	9.82 [6.6]
26	—	—	2.59 [0.102]	12.05 [8.1]
24	2.26 [0.089]	11.76 [7.9]	2.99 [0.118]	16.82 [11.3]
22	2.57 [0.101]	15.48 [10.4]	3.35 [0.132]	21.57 [14.5]
20	2.77 [0.109]	19.19 [12.9]	3.76 [0.148]	27.97 [18.8]
18	3.02 [0.119]	24.11 [16.2]	4.32 [0.170]	38.24 [25.7]
16	3.25 [0.128]	28.13 [18.9]	4.67 [0.184]	44.94 [30.2]
14	3.73 [0.147]	38.69 [26.0]	5.53 [0.218]	64.28 [43.2]
12	4.19 [0.165]	52.38 [35.2]	6.50 [0.256]	91.51 [61.5]

Other sizes are also available in some constructions depending on conductor type and construction required.

SPEC 55

Product Facts

- Resistant to electrical arc tracking in wet or dry conditions
- Single or dual wall constructions
- Small size, ultra light weight
- Exceptional chemical resistance
- -65°C to 200°C [-85°F to 392°F]



Applications

SPEC 55 wire is insulated with modified radiation cross-linked ETFE polymer. It has a temperature rating of -65°C to 200°C [-85°F to 392°F] continuous using a silver plated copper conductor, and combines the easy handling of a flexible wire with excellent scrape abrasion and cut-through characteristics.

The dual wall airframe construction of SPEC 55 wire is currently used on numerous aircraft programs. It has a choice of two total wall thicknesses, 0.25 [.010] (55A08XX 10 mil) and 0.2 [.008] (55A02XX 8 mil). Both have a contrasting core color to act as a damage indicator. Chosen for its balance of properties, SPEC 55 wire has outstanding resistance to chemicals and solvents, excellent electrical arc track resistance, and is not susceptible to UV and moisture degradation. Single wall equipment wire constructions are available in 0.10 [.004] (55/03XX 4 mil) and 0.15 [.006] (6 mil) wall thicknesses for use inside black boxes where flexibility and solder-iron resistance make it a wire which is very easy to install reliably.

Both single and dual wall insulated wires are available

in twisted pairs, triples, etc., and as shielded and jacketed cables.

Physical Characteristics

Size and Weight

SPEC 55 wire provides one of the most comprehensive wiring product ranges for aerospace users, with a wide choice of conductor sizes and insulation wall thicknesses. The dual wall airframe wire has an insulation wall thickness of either 0.2 [.008] or 0.25 [.010] for robustness in unprotected harnesses and has excellent wire to wire abrasion properties.

The single wall equipment wire has a 0.15 [.006] wall thickness for use inside equipment and protected harnesses. For high density, interconnect wiring, the 450 volt 55M041X series of equipment wire has a nominal 0.1 [.004] wall and provides considerable weight and size savings over other comparable wires.

Handling

The excellent flexibility and handleability makes SPEC 55 the ideal wire to install, both in new aircraft and equipment and for maintenance purposes. The wire is easily stripped with conventional tooling. The insulation is readily marked

by hot stamp, ink jet or laser, and can be potted without pre-etching.

SPEC 55PC Wire and Cable Insulation System

This product was originally developed to meet Boeing's material standard BMS13-48 for the 777 airliner. SPEC 55PC provides lightweight, compact insulation that matches the proven performance of our SPEC 55 wire. Today, 55PC is specified and utilized on the majority of aerospace platforms worldwide.

Tyco Electronics' rigorous, statistical-process-controlled manufacturing has produced Raychem wiring that is rugged and versatile enough for a wide range of commercial and defense aerospace applications, including electronic hook-ups in harsh, open airframe environments.

SPEC 55PC wire and cable systems feature an 8-mil airframe wire that is lighter and smaller than typical 10-mil wire, with little reduction in key mechanical performance features. SPEC 55PC wire offers flame resistance superior to FAA standards and also resists scrape abrasion, notch, propagation, cut-through, and electrical arc tracking.

- Meets Boeing material standard BMS 13-48.
- Exceeds FAR 25 test requirements for flame resistance and smoke density.

Available in:

- Americas ■
- Europe ■
- Asia Pacific ■

SPEC 55 (Continued)

Specifications

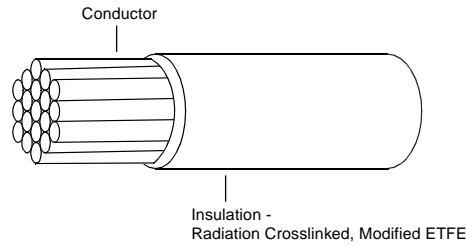

SPEC 55 insulation system - single wall

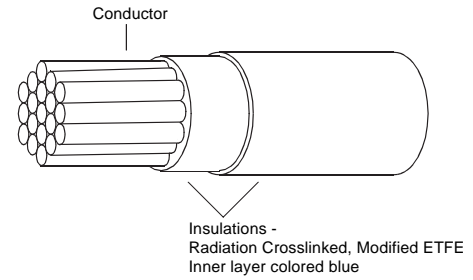

SPEC 55 insulation system - dual wall

MIL-W-22759/32-35 and /41 to /46 and NEMA-WC-27500 (Cables)
Defense Standard 61-12 Part 33 Issue 4
Part 1001 and Part 1002
VDE 9426, 9427, 9428
British Standard 3G233
Civil Aviation Authority Accessory Approval E11749
Boeing BMS 13-48
Airbus ABS 0820 to 0826
NASA preferred product list
European Space Agency 3901/012, 3901/020 and 3901/022
Raychem Specification 55

Typical Properties

Temperature rating (Tin plated conductor)	-65°C to +150°C [-85°F to +302°F]
(Silver or nickel plated conductor)	-65°C to +200°C [-85°F to +392°F]
Thermal endurance	200 °C [392°F], 10000 h
Scrape abrasion (BS 3G233)	>100 cycles at 150°C [302°F]
Flexing endurance (Boeing BSS 7324)	>1000 cycles
Voltage rating	600 V, 450V
Tensile strength + elongation (core only)	(Dual wall wire) 35 N/mm2, 125% min.
Tensile strength + total elongation (core & primary jacket)	(Dual wall wire) 35 N/mm2, 75% min.
Notch propagation BS 3G230 0.05 mm notch	Pass
Solder iron resistance (370 °C, 1 minute)	Pass
Solderability - Tin plated copper conductor BS 3G233 conditions	<0.8 secs to wet
Shrinkage	<1%
Long term water resistance	Will not hydrolyze
Permittivity 1 KHz (ASTM D150)	2.7
Dissipation factor (ASTM D150)	0.001
FAR 25	⊖
Afterburn (sec)	30 sec. max.
Burn length	75 mm [3 in.] max.

SPEC 55 (Continued)

Environmental Performance

Temperature Rating

SPEC 55 wire and cable is rated for continuous operation from -65°C to +200°C [-85°F to +392°F] and for short periods at temperatures as high as 400°C [752°F].

Mechanical Performance

Radiation crosslinking of the SPEC 55 insulation significantly improves the following mechanical characteristics; scrape (sharp edges), cross wire abrasion, cut-through resistance and creep resistance.

Solder Iron/Overload Resistance

Radiation crosslinking ensures that the insulation resists melting at high temperatures. As a result SPEC 55 wire is resistant to hot solder irons and current overloads which would melt most thermoplastic insulations.

Chemical Resistance

SPEC 55 is unaffected by all commonly used chemicals, eg. fuels, hydraulic fluids, defluxing agents, cleaners, coolants and de-icers. It also shows excellent resistance to weathering (UV, ozone, pollutants, water).

Space Wire

SPEC 55 is available in special versions suitable for use in outer space meeting both ESA and NASA requirements for outgassing.

Flammability

Special additives increase the flame retardance of SPEC 55 compared to unirradiated ETFE so that it meets the latest high performance tests, eg. BS 3G230 vertical test FAR 25.

Electrical Arc Tracking Resistance

SPEC 55 insulation demonstrates resistance to arc tracking under both wet and dry conditions at aircraft system voltages.

SPEC 55 Wire & Cable:
Standard Constructions,
Nominal Sizes, Strandings,
Diameters and Weights



55PC - Extra Light Weight Constructions

For applications where weight is critical, light weight tight tolerance conductors and insulations are available. These are manufactured using statistical process control methods and achieve weights that are equal or lighter than the equivalent polyimide/PTFE constructions.

Electronics

55A - AWG Conductor:
Equipment/Interconnect Wires
& Cables

SPEC 55 (Continued)

Wire Size (AWG)	Stranding (mm)	55A011X		55A012X	
		Nom. OD	Max. Weight (g per m/lbs per kft)	Nom. OD	Max. Weight (g per m/lbs per kft)
30	7/0.102	0.61 [0.024]	0.98 [0.66]	1.27 [0.048]	1.94 [1.3]
28	7/127	0.68 [0.027]	1.35 [0.91]	1.42 [0.054]	2.68 [1.8]
26	19/102	0.81 [0.032]	2.08 [1.4]	1.67 [0.064]	4.16 [2.8]
24	19/127	0.94 [0.037]	2.98 [2.0]	1.93 [0.074]	5.96 [4.0]
22	19/0.16	1.09 [0.043]	4.17 [2.8]	2.23 [0.086]	8.63 [5.8]
20	19/0.203	1.27 [0.050]	6.40 [4.3]	2.66 [0.102]	13.24 [8.9]
18	19/0.25	1.52 [0.060]	9.67 [6.5]	3.20 [0.122]	20.09 [13.5]
16	19/287	1.73 [0.068]	12.35 [8.3]	3.58 [0.138]	25.75 [17.3]
14	19/0.36	2.20 [0.085]	19.34 [13.0]	4.47 [0.172]	39.58 [26.6]
12	37/0.32	2.62 [0.103]	29.32 [19.7]	5.38 [0.208]	59.97 [40.3]
10	37/0.403	3.25 [0.128]	47.32 [31.8]	6.65 [0.256]	96.58 [64.9]
8	133/0.287	4.77 [0.188]	87.50 [58.8]	9.80 [0.376]	178.58 [120.0]

Wire Size (AWG)	55A111X		55A112X	
	Nom. OD	Max. Weight (g per m/lbs per kft)	Nom. OD	Max. Weight (g per m/lbs per kft)
30	1.51 [0.057]	5.06 [3.4]	2.12 [0.081]	7.74 [5.2]
28	1.59 [0.060]	5.80 [3.9]	2.27 [0.087]	8.90 [6.0]
26	1.71 [0.065]	6.85 [4.6]	2.53 [0.097]	11.32 [7.6]
24	1.84 [0.070]	8.19 [5.5]	2.80 [0.107]	13.84 [9.3]
22	1.99 [0.076]	10.27 [6.9]	3.07 [0.119]	17.86 [12.0]
20	2.20 [0.084]	13.40 [9.0]	3.50 [0.135]	23.81 [16.0]
18	2.45 [0.094]	17.86 [12.0]	4.10 [0.155]	32.60 [21.9]
16	2.67 [0.102]	21.73 [14.6]	4.43 [0.171]	39.73 [26.7]
14	3.10 [0.119]	30.36 [20.4]	5.30 [0.205]	57.00 [38.3]
12	3.55 [0.137]	42.41 [28.5]	6.30 [0.243]	81.10 [54.5]
10	4.20 [0.161]	62.65 [42.1]	—	—
8	5.80 [0.223]	110.42 [74.2]	—	—

55A - AWG Conductor:
Airframe Wires & Cables

Wire Size (AWG)	Stranding (mm)	55A081X		55A082X	
		Nom. OD	Max. Weight (g per m/lbs per kft)	Nom. OD	Max. Weight (g per m/lbs per kft)
26	19/102	1.01 [0.040]	2.5 [1.7]	2.10 [0.080]	5.06 [3.4]
24	19/127	1.14 [0.045]	3.4 [2.3]	2.33 [0.090]	6.84 [4.6]
22	19/0.16	1.27 [0.050]	4.8 [3.2]	2.64 [0.102]	9.98 [6.7]
20	19/0.203	1.47 [0.058]	7.0 [4.7]	3.07 [0.118]	14.73 [9.9]
18	19/0.25	1.78 [0.070]	10.7 [7.2]	3.63 [0.140]	21.88 [14.7]
16	19/287	1.96 [0.077]	13.4 [9.0]	4.06 [0.156]	27.53 [18.5]
14	19/0.36	2.40 [0.094]	20.5 [13.8]	4.90 [0.190]	42.26 [28.4]
12	37/0.32	2.82 [0.111]	30.5 [20.5]	5.80 [0.224]	63.00 [42.3]
10	37/0.403	3.40 [0.134]	48.3 [32.4]	7.10 [0.272]	98.96 [66.5]

Wire Size (AWG)	55A181X		55A182X	
	Nom. OD	Max. Weight (g per m/lbs per kft)	Nom. OD	Max. Weight (g per m/lbs per kft)
26	1.71 [0.073]	7.89 [5.3]	2.63 [0.113]	14.29 [9.6]
24	1.84 [0.078]	9.37 [6.3]	2.80 [0.123]	16.37 [11.0]
22	1.99 [0.084]	11.76 [7.9]	3.07 [0.135]	20.68 [13.9]
20	2.20 [0.092]	14.88 [10.0]	3.50 [0.151]	27.08 [18.2]
18	2.45 [0.103]	19.79 [13.3]	4.10 [0.173]	36.46 [24.5]
16	2.67 [0.111]	23.81 [16.0]	4.43 [0.189]	42.86 [28.8]
14	3.10 [0.128]	33.03 [22.2]	6.30 [0.225]	61.61 [41.4]
12	3.55 [0.145]	45.09 [30.3]	6.30 [0.259]	85.42 [57.4]
10	4.20 [0.168]	66.97 [45.0]	— [0.308]	127.54 [85.7]

55PC - AWG Conductor:
Statistical Process Controlled
Airframe Wires & Cables

SPEC 55 (Continued)

Wire Size (AWG)	Stranding (mm)	55PC021X		55PC022X	
		Nom. OD	Max. Weight (g per m/lbs per kft)	Nom. OD	Max. Weight (g per m/lbs per kft)
26	19/102	0.087 [0.045]	2.05 [1.38]	—	—
24	19/127	1.00 [0.0395]	2.95 [1.98]	2.00 [0.079]	5.95 [4.00]
22	19/0.16	1.15 [0.0455]	4.31 [2.90]	2.31 [0.091]	8.74 [5.87]
20	19/0.203	1.37 [0.0540]	6.51 [4.38]	2.74 [0.108]	13.2 [8.87]
18	19/0.25	1.61 [0.0635]	9.81 [6.59]	3.22 [0.127]	19.84 [13.33]
16	19/287	1.80 [0.0710]	12.46 [8.37]	3.60 [0.142]	25.21 [16.94]
14	19/036	2.18 [0.0860]	19.17 [12.88]	4.36 [0.172]	38.80 [26.07]
12	37/0.32	2.66 [0.1047]	29.36 [19.73]	5.30 [0.209]	59.42 [39.93]
10	37/0.403	3.27 [0.1290]	46.31 [31.12]	6.55 [0.258]	93.92 [63.11]

Wire Size (AWG)	55PC121X		55PC122X	
	Nom. OD	Max. Weight (g per m/lbs per kft)	Nom. OD	Max. Weight (g per m/lbs per kft)
26	1.52 [0.064]	6.54 [4.4]	2.33 [0.100]	11.34 [7.62]
24	1.65 [0.069]	7.86 [5.28]	2.89 [0.109]	13.90 [9.34]
22	1.80 [0.075]	9.81 [6.59]	2.89 [0.122]	17.89 [12.02]
20	2.00 [0.083]	12.83 [8.62]	3.30 [0.139]	23.84 [16.02]
18	2.23 [0.093]	17.01 [11.43]	3.78 [0.158]	32.10 [21.57]
16	2.44 [0.100]	20.36 [13.68]	4.16 [0.174]	39.00 [26.21]
14	2.79 [0.116]	28.69 [19.28]	4.92 [0.204]	55.21 [37.10]
12	3.30 [0.135]	40.73 [27.37]	5.92 [0.244]	80.23 [53.91]
10	3.98 [0.159]	59.90 [40.25]	7.39 [0.297]	123.65 [83.09]

X = 1 - Tin plated copper conductor.

4 - Silver plated high strength copper alloy conductor. (Recommended for size 24 & 26 in airframe applications and mandatory for CAA release.)

Part Numbering System

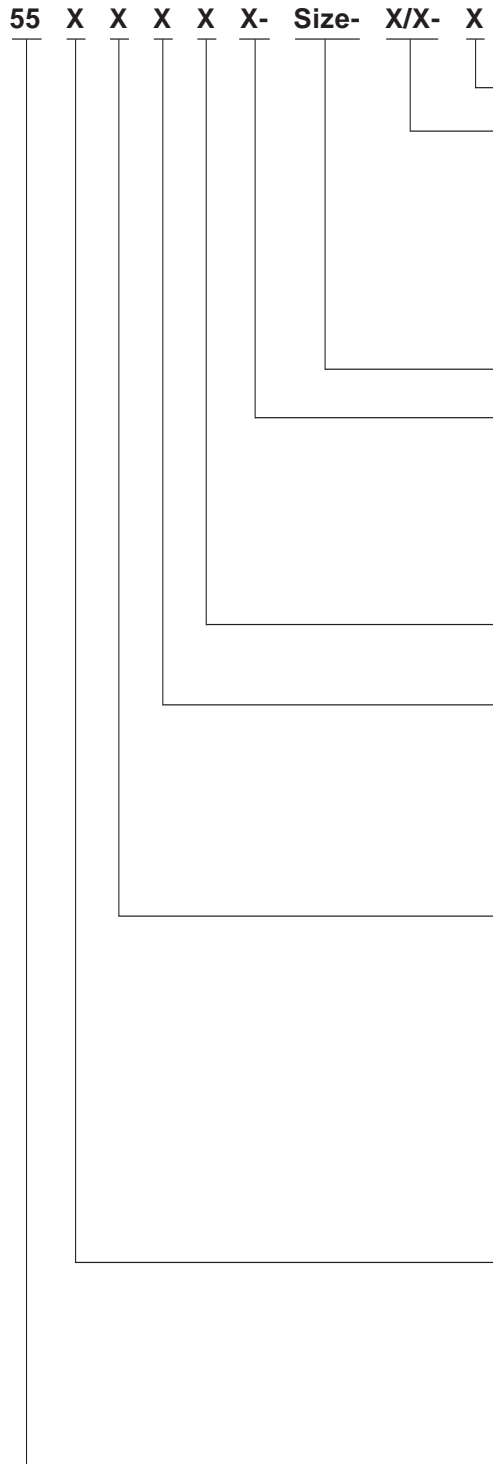

Jacket Color (in accordance with MIL-STD-681, white preferred)

Primary Wire Insulation Color

(in accordance with MIL-STD-681)

- | | | |
|-----------|------------|------------|
| 0 - Black | 3 - Orange | 7 - Violet |
| 1 - Brown | 4 - Yellow | 8 - Gray |
| 2 - Red | 5 - Green | 9 - White |
| 2L - Pink | 6 - Blue | |

Additional number after base color indicates stripe

Conductor Size

Conductor Type

- 1 - Tin-plated copper
- 2 - Silver-plated copper
- 3 - Nickel-plated copper
- 4 - Silver-plated high strength copper alloy
- 6 - Nickel-plated high strength copper alloy

Number of Conductors

- 0 - 10 conductors

Class of Wire

- 1 - 600 V equipment wire, light weight
- 2 - 600 V airframe wire, light weight
- 4 - 450 V equipment wire (55M Only sizes 20-30)
- 7 - 1000 V heavy duty, airframe wire
- 8 - 600 V airframe wire, normal weight

Constructions

- 0 - Primary wire and shielded, unjacketed cables
- 1 - Round braid screened & jacketed cable †
- 2 - Flat braid screened & jacketed cable †
- 3 - Round braid, screened cable, no jacket †
- 4 - Jacketed cable, no screen
- 5 - Spiral screened and jacketed cable †
- 8 - Special constructions (part numbers not coded)
- 9 - Special constructions including light weight

† Screen material same as conductor material except all flat screens and screen for conductor types 4 and 6 shall be tin-plated copper. Other combinations are special. (Refer to Wire and Cable Division).

Type

- A - General purpose
- M - Metric conductor
- / - Space wire
- PC- Process control
- D - Defense Standard 61-12 Part 33 Issue 4





Basic Specification Number

Typical Ordering Example	3 conductors, red, yellow, blue, 600 volt equipment wire with overall round braid, 20 AWG tinned conductor and white jacket: total part number is 55A1131-20-2/4/6-9.
Ordering Information	A list of stock policy items can be identified by contacting Tyco Electronics. Stock policy items are recognized by the use of a suffix, such as (300) defining the pack size, typically 55A0111-22-9(300). UK only.

SPEC 55 Part Numbering System

Temperature Rating	Conductor Material	AWG Range Available	Raychem Part No.	MIL-SPEC No.
600-V Lightweight Single-wall Hookup Wire, .152 [.006] Nominal Wall				
150°C [302°F]	Tin-coated copper	12-30	55A0111	M22759/32
200°C [392°F]	Silver-coated copper	12-28	55A0112	M22759/44
200°C [302°F]	Nickel-coated copper	12-28	55A0113	M22759/45
200°C [392°F]	Silver-coated high-strength alloy	20-30	55A0114	M22759/33
200°C [392°F]	Nickel-coated high-strength alloy	20-28	55A0116	M22759/46
600-V Lightweight Dual-wall Airframe Wire, .203 [.008] Nominal Wall				
150°C [302°F]	Tin-coated copper	6-26	55A0211	—
200°C [392°F]	Silver-coated copper	10-26	55A0212	—
200°C [392°F]	Nickel-coated copper	10-26	55A0213	—
200°C [392°F]	Silver-coated high-strength alloy	18-30	55A0214	—
200°C [392°F]	Nickel-coated high-strength alloy	16-26	55A0216	—
600-V Dual-wall Airframe Wire, .254 [.010] Nominal Wall				
150°C [302°F]	Tin-coated copper	00-24	55A0811	M22759/34
200°C [392°F]	Silver-coated copper	00-26	55A0812	M22759/43
200°C [392°F]	Nickel-coated copper	00-26	55A0813	M22759/41
200°C [392°F]	Silver-coated high-strength alloy	20-26	55A0814	M22759/35
200°C [392°F]	Nickel-coated high-strength alloy	20-26	55A0816	M22759/42
600-V Medium-Weight Dual-wall Airframe Wire, .381 [.015] Nominal Wall				
150°C [302°F]	Tin-coated copper	10-24	55A0711	—
200°C [392°F]	Silver-coated copper	16-24	55A0712	—
200°C [392°F]	Nickel-coated copper	16-24	55A0713	—
200°C [392°F]	Silver-coated high-strength alloy	16-24	55A0714	—
200°C [392°F]	Nickel-coated high-strength alloy	16-26	55A0716	—

SPEC 55 Cable
Constructions

Construction	Number of Components	Component Conductor ¹	Shield Material ¹	Part Number		
				Light Wt. ²	Medium Wt.	
Unshielded, unjacketed		2-10	1	—	55*01X1-AWG-Y	55*08X1-AWG-Y
		2	—	55*01X2-AWG-Y	55*08X2-AWG-Y	
		3	—	55*01X3-AWG-Y	55*08X3-AWG-Y	
		4	—	55*01X4-AWG-Y	55*08X4-AWG-Y	
		6	—	55*01X6-AWG-Y	55*48X6-AWG-Y	
Unshielded, jacketed		2-10	1	—	55*41X1-AWG-Y	55*48X1-AWG-Y
		2	—	55*41X2-AWG-Y	55*48X2-AWG-Y	
		3	—	55*41X3-AWG-Y	55*48X3-AWG-Y	
		4	—	55*41X4-AWG-Y	55*48X4-AWG-Y	
		6	—	55*41X6-AWG-Y	55*18X6-AWG-Y	
Shielded (round braid), jacketed		1-10	1	1	55*11X1-AWG-Y	55*18X1-AWG-Y
		2	2	55*11X2-AWG-Y	55*18X2-AWG-Y	
		3	3	55*11X3-AWG-Y	55*18X3-AWG-Y	
		4	1	55*11X4-AWG-Y	55*18X4-AWG-Y	
		6	3	55*11X6-AWG-Y	55*18X6-AWG-Y	
Shielded (flat braid), jacketed		1-10	1	1	55*21X1-AWG-Y	55*28X1-AWG-Y
		2	1	55*21X2-AWG-Y	55*28X2-AWG-Y	
		3	1	55*21X3-AWG-Y	55*28X3-AWG-Y	
		4	1	55*21X4-AWG-Y	55*28X4-AWG-Y	
		6	1	55*21X6-AWG-Y	55*28X6-AWG-Y	

¹Type of conductor or shield material:
 1 = tin-coated copper
 2 = silver-coated copper
 3 = nickel-coated copper
 4 = silver-coated high-strength copper alloy
 6 = nickel-coated high-strength copper alloy
 * = A or PC

² X = no. of wire components
 Y = color code
 For complete part number, see Part Numbering System on page 9-15.

NEMA WC-27500 Cable
Part Numbering System

M27500 X AWG XX X X XX

Basic Specification Number

Component Wire ID/Shield Coverage Code

Shield Coverage

85%	90%
-	C
A	D
B	E
F	H
G	J
K	M
L	N
P	R
S	T

Component Wire Identification

Colored Stripes on White Wire
(9/96/93/95/92/90/94/97/98/91... etc.)
Solid Color Wires (9/6/3/5/2/0/4/7/8/1...etc.)
Band Marks on Solid Colors (by AWG)
Alternate Colored Stripes
(92/96/94/95/9/90/91/93/97/98...etc.)
Alternate Solid Colors (2/6/4/5/9/0/1/3/7/8...etc.)
Number Marking on Solid Colors (by AWG)
Number Marking on White Wires
Band Marks on Colored Stripes (by AWG)
Band Marks on White Wires

Conductor Size (AWG)

Basic Wire Spec Code (MIL-W-22759) and Slash Sheet

SB - 32 = 55A0111
SC - 33 = 55A0114
SD - 34 = 55A0811
for 2 AWG and larger, use 55A8039
SE - 35 = 55A0814
SM - 41 = 55A0813
for 2 AWG and larger, use 55A8595
SN - 42 = 55A0816
SP - 43 = 55A0812
for 2 AWG and larger, use 55A6089
SR - 44 = 55A0112
SS - 45 = 55A0113
ST - 46 = 55A0116

Number of Component Wires

1 through 9; 10 Components = 0

Shield Material and Style Code

U - No shield
T - Tin-coated copper, round
J - Tin-coated copper, flat
S - Silver-coated copper, round
G - Silver-coated copper, flat
N - Nickel-coated copper, round
V - Tin-coated copper, round, double shield
W - Silver-coated copper, round, double shield

Jacket Material and Style Code

00 - No jacket
23 - Single jacket crosslinked, modified ETFE, white
73 - Double jacket crosslinked, modified ETFE, white

Example: **M27500-22SB3T23 = 55AM1131-22-9/96/93-9**

Raychem Part No.
Military Part No.

RCW

Product Facts

- -65°C to +260°C [-85°F to +500°F]
- Small size, ultra light weight
- Resistant to electrical arc tracking in wet or dry conditions
- Excellent cut-through resistance
- Exceptional chemical resistance

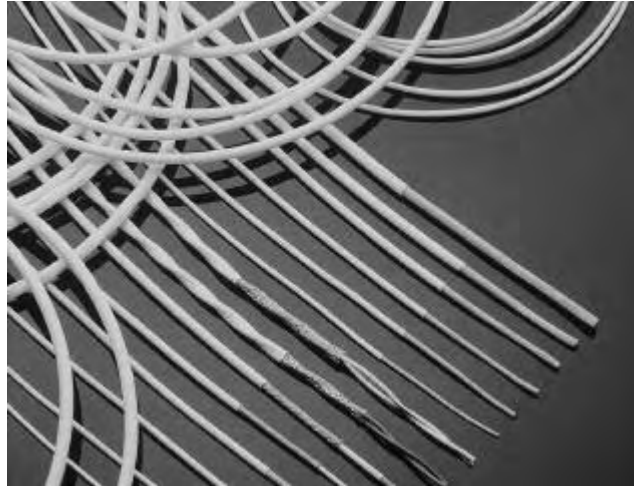

Applications

Raychem Composite Wire (RCW) is insulated with a combination of PTFE and Polyimide materials. It has a temperature rating of -65°C to +260°C [-85°F to +500°F] continuous using a nickel-plated conductor, and combines the easy handling of a flexible wire with excellent cut-through characteristics.

Chosen for its balance of properties, RCW has outstanding resistance to chemicals and solvents, excellent arc track resistance, and is not susceptible to UV and moisture degradation.

RCW can be supplied in a thin wall, lightweight construction which provides considerable weight and size savings over comparable wires.

RCW is available in twisted pairs, triples, etc. and shielded and jacketed constructions.

Physical Characteristics

Size and Weight

RCW provides one of the most comprehensive wiring product ranges for aerospace users with a wide choice of conductor sizes and insulation wall thicknesses.

RCW airframe wire has an insulation wall thickness of either .006" or 0.008" for robustness in unprotected harnesses and has excellent wire-to-wire abrasion properties.

Handling

Excellent flexibility and handleability makes RCW ideal for installation in new aircraft and equipment, and is easily replaced during maintenance procedures.

RCW is easily stripped with conventional tooling, and readily marked by laser or ink jet.

Available in:	
Americas	■
Europe	■
Asia Pacific	■

RCW (Continued)

Specifications

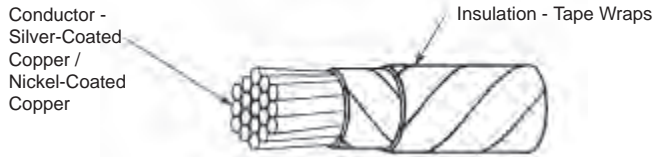

RCW insulation system

MIL-DTL-22759/81-92

Lockheed Martin Selected C-Specs

Typical Properties

	Lightweight / Normal Weight
Conductor	Silver Copper / Nickel Copper
Temperature	-65°C to +200°C [-85°F to +392°F] / -65°C to +260°C [85°F to +500°F]
Voltage Rating	600V
Dielectric Strength	4,000 volts/mil (avg. min.)
Wet Arc Propagation Resistance	MIL-STD-2223 Method 3006 *
Dry Arc Propagation Resistance	MIL-DTD-2223 Method 3007 *
Dynamic Cut-Through	ASTM D 3032 Section 22 *
Flammability	MIL-STD-2223, Method 1006, Procedure A *
Insulation Resistance	5000 megohms for 1000 ft. (min.)
Life Cycle	500 hours @ 230°C [446°F] / 500 hrs @ 290°C [554°F]
Low Temperature (Cold Bend)	-65°C [-85°F] (4 hrs)
Smoke	200°C [392°F] / 260°C [500°F] No visible smoke
Thermal Index	200°C [392°F] min. / 260°C min. [500°F] 10,000 hrs.

*as defined by the applicable MIL-Spec slash sheets

Environmental Performance

Temperature Rating

RCW wire and cable is rated for continuous operation from -65°C to +260°C [-85°F to +500°F] and for short periods at temperatures as high as 320°C [608°F].

Mechanical Performance

RCW incorporates superior abrasion protection and cut-through performance. Like all Raychem products, this latest addition is designed for electrical and electronic applications in tough environments.

Chemical Resistance

RCW is unaffected by all commonly used chemicals, eg. fuels, hydraulic fluids, defluxing agents, cleaners, coolants and de-icers. It also shows excellent resistance to weathering (UV, ozone, pollutants, water). RCW is highly resistant to hydrolysis.

Flammability/Smoke

Advanced combination of materials allow superior performance in areas such as flammability and smoke generation properties. Exceeds FAR 25 test requirements for flame resistance and smoke density.

Electrical Arc Tracking Resistance

RCW insulation demonstrates resistance to arc tracking under both wet and dry conditions at aircraft system voltages.

RCW Wire & Cable: Standard Constructions, Nominal Sizes, Strandings, Diameters and Weights

Conductor	Primary Wire	Twisted Pair	Shielded & Jacketed	
			Single	Pair

Electronics

RCW - AWG Conductor:
Equipment/Interconnect Wires
& Cables
(Lightweight)

RCW (Continued)

Wire Size (AWG)	Stranding (mm)	RCW59XX		RCWxWx2U00-AWG	
		Nom. OD (max.)	Max. Weight (g per m/lbs per kft)	Nom. OD (max.)	Max. Weight (g per m/lbs per kft)
26	19 x 38	0.48 [0.019]	2.13 [1.43]	1.73 [0.068]	4.35 [2.92]
24	19 x 36	0.61 [0.024]	2.87 [1.93]	1.93 [0.076]	5.86 [3.94]
22	19 x 34	0.76 [0.030]	4.24 [2.85]	2.18 [0.086]	8.65 [5.81]
20	19 x 32	0.97 [0.038]	6.52 [4.38]	2.59 [0.102]	13.30 [8.94]
18	19 x 30	1.22 [0.048]	9.82 [6.60]	3.05 [0.120]	20.09 [13.5]
16	19 x 29	1.37 [0.054]	12.35 [8.30]	3.40 [0.134]	25.15 [16.9]
14	19x 27	1.73 [0.068]	18.75 [12.6]	4.06 [0.160]	38.25 [25.7]
12	37 x 28	2.21 [0.087]	29.17 [19.6]	5.08 [0.200]	59.53 [40.0]
10	37 x 26	2.79 [0.110]	45.54 [30.6]	6.25 [0.246]	92.86 [62.4]

Wire Size (AWG)	Shield Size (AWG)	RCWxWx1xxx-AWG-x		RCWxWx2xxx-AWG-x	
		Nom. OD max.	Max. Weight@90% (g per m/lbs per kft)	Nom. OD max.	Max. Weight@90% (g per m/lbs per kft)
26	38	1.83 [0.072]	8.27 [5.56]	2.69 [0.106]	13.84 [9.30]
24	38	1.93 [0.076]	9.52 [6.40]	2.89 [0.114]	16.22 [10.9]
22	38	2.06 [0.081]	11.55 [7.76]	3.15 [0.124]	20.24 [13.6]
20	38	2.26 [0.089]	14.88 [10.0]	3.56 [0.140]	26.64 [17.9]
18	38	2.49 [0.098]	19.35 [13.0]	4.01 [0.158]	35.42 [23.8]
16	38	2.67 [0.105]	22.77 [15.3]	4.37 [0.172]	42.12 [28.3]
14	38	2.99 [0.118]	30.95 [20.8]	5.03 [0.198]	58.19 [39.1]
12	38	3.50 [0.138]	44.05 [29.6]	6.15 [0.242]	85.57 [57.5]
10	38	4.09 [0.161]	63.69 [42.8]	7.32[0.288]	124.41[83.6]

RCW - AWG Conductor:
Airframe Wires & Cables
(Normal Weight)

Wire Size (AWG)	Stranding (mm)	RCW59xx		RCWxWx2U00-AWG	
		Nom. OD max.	Max. Weight (g per m/lbs per kft)	Nom. OD max.	Max. Weight@90% (g per m/lbs per kft)
26	19 x 38	0.52 [0.0204]	2.31 [1.55]	1.88 [0.074]	4.70 [3.16]
24	19 x 36	0.62 [0.0244]	3.19 [2.15]	2.13 [0.084]	6.53 [4.39]
22	19 x 34	0.87 [0.0314]	4.46 [3.00]	2.39 [0.094]	9.11 [6.12]
20	19 x 32	1.00 [0.0394]	6.77 [4.55]	2.79 [0.110]	13.81 [9.28]
18	19 x 30	1.25 [0.0494]	9.97 [6.70]	3.30 [0.130]	20.39 [13.70]
16	19 x 29	1.41 [0.0554]	12.80 [8.60]	3.71 [0.146]	26.04 [17.50]
14	19 x 27	1.76 [0.0694]	19.27 [12.95]	4.37 [0.172]	39.29 [26.40]
12	37 x 28	2.27 [0.0894]	29.91 [20.10]	5.33 [0.210]	61.01 [41.00]
10	37 x 26	2.84 [0.112]	46.73 [31.40]	6.45 [0.254]	95.39 [64.10]
8	133 x 29	4.29 [0.169]	85.72 [57.60]	9.55 [0.376]	174.86[117.50]
6	133 x 27	5.38 [0.212]	131.40 [88.30]	—	—
4	133 x 25	6.81 [0.268]	212.81 [143.0]	—	—

Wire Size (AWG)	Shield Size (AWG)	RCWxWx1xxx-AWG-x		RCWxWx2xxx-AWG-x	
		Nom. OD max.	Max. Weight@90% (g per m/lbs per kft)	Nom. OD max.	Max. Weight@90% (g per m/lbs per kft)
26	38	1.91 [0.075]	8.82 [5.93]	2.84 [0.112]	14.88 [10.0]
24	38	2.03 [0.080]	10.45 [7.02]	3.10 [0.122]	18.01 [12.1]
22	38	2.16 [0.085]	12.28 [8.25]	3.35 [0.132]	21.58 [14.5]
20	38	2.36 [0.093]	15.63 [10.50]	3.76 [0.148]	27.98 [18.8]
18	38	2.62 [0.103]	20.09 [13.50]	4.27 [0.168]	36.76 [24.7]
16	38	2.82 [0.111]	24.11 [16.20]	4.67 [0.184]	44.35 [29.8]
14	38	3.15 [0.124]	32.29 [21.70]	5.33 [0.210]	60.57 [40.7]
12	38	3.63 [0.143]	45.54 [30.60]	6.40 [0.252]	88.25 [59.3]
10	38	4.19 [0.165]	65.33 [43.90]	7.52 [0.296]	127.83 [85.9]

Part Numbering System —
Cable
(Per NEMA WC 27500)

RCW X XX # X XX - AWG - X

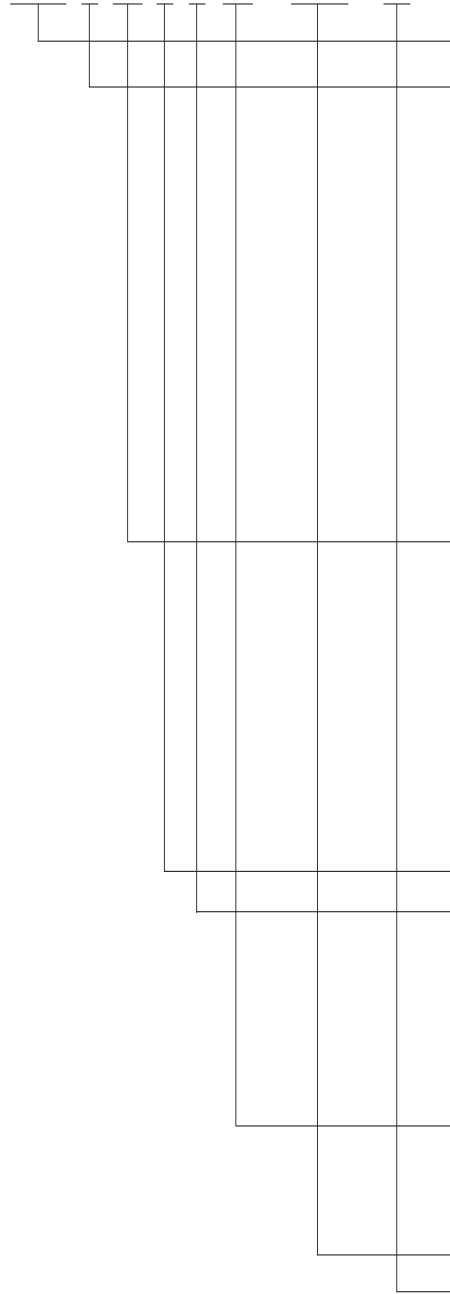

Basic Product Number

Component Wire ID/Shield Coverage Code (per WC 27500)

(Note: Some ID methods of WC 27500 may not be available - standard codes offered are A, B, D and E, as defined below)

- A - 85% min. shield cov. (if applic.); solid wire colors selected in order from the following: White, Blue, Orange, Green, Red, Black, Yellow, Violet, Gray, Brown
- B - 85% min. shield coverage (if applic.); band-marked solid wire colors based on AWG size as follows:

AWG	Color	AWG	Color	AWG	Color
26	Black	18	White	10	Brown
24	Blue	16	Blue	8	Red
22	Green	14	Green	6	Blue
20	Red	12	Yellow	4	Yellow

- D - Same as A, except 90% min. shield coverage
- E - Same as B, except 90% min. shield coverage

Component Wire Code (per WC 27500) and MIL-W-22759 Slash Sheet

- WC = 81 = RCW5981
- WE = 82 = RCW5982
- WJ = 86 = RCW5986
- WK = 87 = RCW5987
- WM = 89 = RCW5989
- WN = 90 = RCW5990
- WP = 91 = RCW5991
- WR = 92 = RCW5992

Number of Component Wires

Shield Code (per WC 27500)

- U - No Shield
- T - Tin-coated copper, round
- S - Silver-coated copper, round
- N - Nickel-coated copper, round
- G - Silver-coated copper, flat

Jacket Code (per WC 27500)

- 00 - No jacket
- 06 - PTFE tape wrap
- 24 - FP/PI/FP and PTFE tape wraps

Conductor Size (AWG)

Jacket Color Code (per MIL-STD-681)

- 0 - Black
- 1 - Brown
- 2 - Red
- 3 - Orange
- 4 - Yellow
- 5 - Green
- 6 - Blue
- 7 - Violet
- 8 - Gray
- 9 - White

Example:

RCWAWJ2G24-22-9 = M27500A22WJ2G24

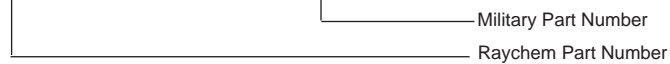

Part Numbering System —
Primary Wire
(Per MIL-W-22759)

RCW59 XX - AWG - X

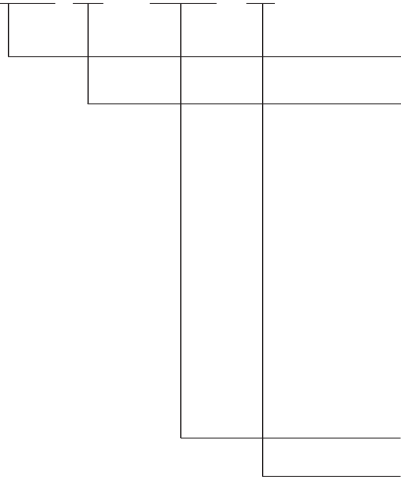

Basic Product Number

MIL-W-22759 Slash Sheet as follows:

- 81 - Lightweight, silver-coated, high-strength or ultra high-strength copper alloy, AWG 26-20
- 82 - Lightweight, nickel-coated, high-strength or ultra high-strength copper alloy, AWG 26-20
- 86 - Normal weight, silver-coated copper, AWG 26-4
- 87 - Normal weight, nickel-coated copper, AWG 26-4
- 89 - Normal weight, silver-coated, high-strength or ultra high-strength copper alloy, AWG 26-20
- 90 - Normal weight, nickel-coated, high-strength or ultra high-strength copper alloy, AWG 26-20
- 91 - Lightweight, silver-coated copper, AWG 26-10
- 92 - Lightweight, nickel-coated copper, AWG 26-10

Conductor Size (AWG)

Insulation Color Code (per MIL-STD-681)

(Note: Colors are in accordance with the UV laser markable color limits specified in the applicable MIL-W-22759 slash sheet. Standard wire color is white).

- | | |
|------------|------------|
| 0 - Black | 5 - Green |
| 1 - Brown | 6 - Blue |
| 2 - Red | 7 - Violet |
| 3 - Orange | 8 - Gray |
| 4 - Yellow | 9 - White |

Example:

RCW5991-22-9 = M27559/91-22-9

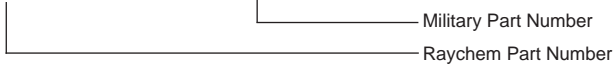

Part Numbering System —
Cable
(Per NEMA WC 27500)

M27500 X AWG XX # X XX

Basic Product Number

Component Wire ID/Shield Coverage Code

(Note: Some ID methods may not be available for RCW cable - standard codes offered are A, B, D and E, as defined below)

A - 85% min. shield cov. (if applic.); solid wire colors selected in order from the following: White, Blue, Orange, Green, Red, Black, Yellow, Violet, Gray, Brown

B - 85% min. shield coverage (if applic.); band-marked solid wire colors based on AWG size as follows:

AWG	Color	AWG	Color	AWG	Color
26	Black	18	White	10	Brown
24	Blue	16	Blue	8	Red
22	Green	14	Green	6	Blue
20	Red	12	Yellow	4	Yellow

D - Same as A, except 90% min. shield coverage

E - Same as B, except 90% min. shield coverage

Conductor Size (AWG)

Basic Wire Spec Code (MIL-W-22759 Slash sheet & RCW Wire)

- WC = 81 = RCW5981
- WE = 82 = RCW5982
- WJ = 86 = RCW5986
- WK = 87 = RCW5987
- WM = 89 = RCW5989
- WN = 90 = RCW5990
- WP = 91 = RCW5991
- WR = 92 = RCW5992

Number of Component Wires

Shield Material and Style Code

- U - No Shield
- T - Tin-coated copper, round
- S - Silver-coated copper, round
- N - Nickel-coated copper, round
- G - Silver-coated copper, flat

Jacket Material and Style Code

- 00 - No jacket
- 06 - PTFE tape wrap, white
- 24 - FP/PI/FP and PTFE tape wraps, white

Example:

M27500A22WJ2G24 = RCWAWJ2G24-22-9

Raychem Part Number

Military Part Number

Product Facts

- Reduced weight
- Flexibility
- Low outgassing
- Function over a broad temperature range
- Flammability
- Arc track resistance
- Resistance to atomic oxygen
- Radiation resistance
- High quality and reliability
- Ease of fabrication (into Harnesses due to flexibility)
- Agency approvals
- -65°C up to +150°C [-85°F up to +302°F]
- Small size
- 600V rating
- Optional high strand count for increased flexibility
- Variety of insulation/jacket options
- Dual wall and single wall options
- Easy to install
- Mechanically tough
- Compliance with FAR 25 flammability requirements
- Resistance to harsh fluids & solvents per MIL-W-22759

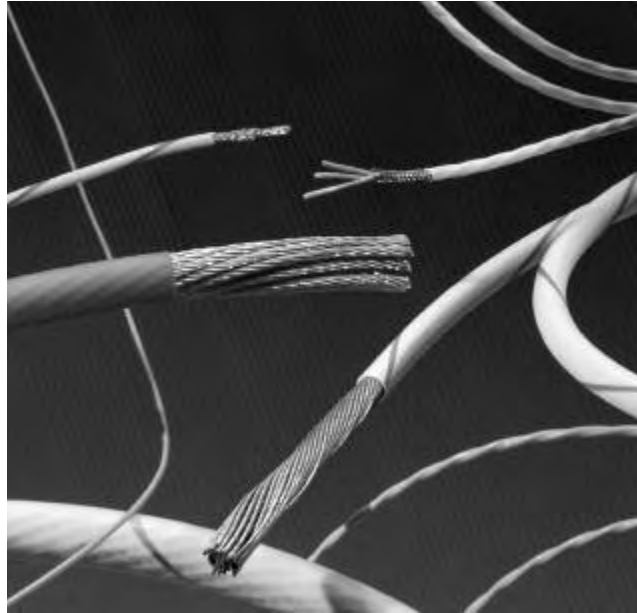

Applications

FlexLine wire (also known as SPEC 80) is insulated with a flexible modified radiation cross-linked ETFE polymer. It has a temperature rating of -65°C to +150°C [-85°F to +302°F] continuous using silver copper conductor, and combines the easy handling of our SPEC 55 wire and cable with additional flexibility. FlexLine wire is used in a broad range of applications, from Hook-up wire to Power Cables.

FlexLine wire constructions provide maximum flexibility similar to the MIL-W-22759 products in Mechanical, Chemical and Thermal properties.

Available in:	Americas	Europe	Asia Pacific
	■	■	■

FlexLine Insulation System

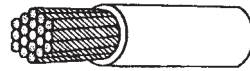

Single Wall

Single Wall 82 Wire
High strand count conductors
Light weight
AWG sizes 28 to 00
(6-mil nominal insulation thickness)

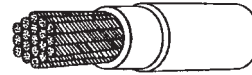

Dual Wall

Dual Wall 81 Wire
Standard M22759 conductor stranding
Increased toughness
AWG sizes 28 to 000
(10-mil nominal insulation thickness)

Part Numbering System

8x X X X X X- Size- X/X- X

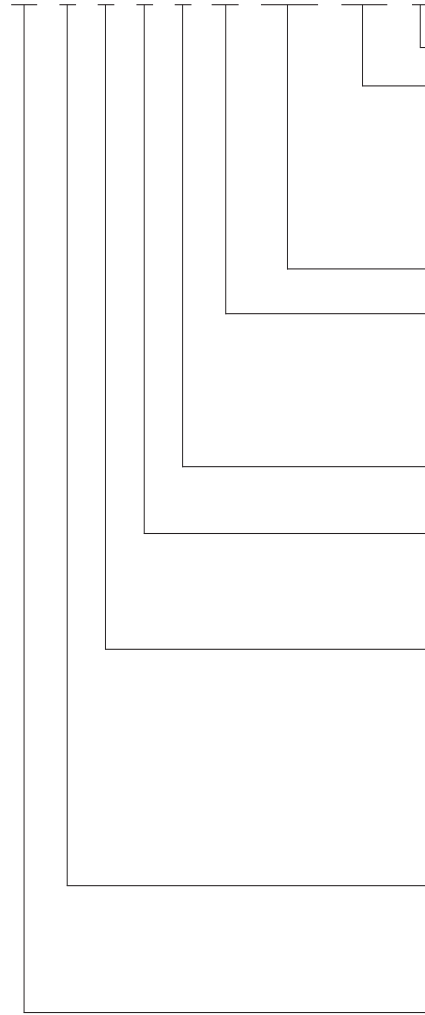

Jacket Color Identification Code (in accordance with MIL-STD-681)

Primary Wire Insulation Color
(in accordance with MIL-STD-681)

- | | | |
|------------|------------|-----------|
| 0 - Black | 4 - Yellow | 8 - Gray |
| 1 - Brown | 5 - Green | 9 - White |
| 2 - Red | 6 - Blue | |
| 3 - Orange | 7 - Violet | |

Conductor Size (AWG)

Conductor Type

- | | |
|--------------------------|--|
| 1 - Tin-coated copper | 4 - Silver-coated high strength copper alloy |
| 2 - Silver-coated copper | 6 - Nickel-coated high strength copper alloy |
| 3 - Nickel-coated copper | |

Number of Conductors

1 through 9

Class of Wire

- 1 - 600 V general purpose wire, lightweight
- 8 - 600 V airframe wire, normal weight

Construction

- 0 - Primary wire & unshielded, unjacketed
- 1 - Round-braid shielded & jacketed cable*
- 2 - Flat-braid shielded & jacketed cable*
- 3 - Round-braid shielded cable, no jacket*
- 4 - Jacketed cable, no shield
- 5 - Spiral-shielded & jacketed cable*
- 6-9 Special constructions

Wire Type

- A - General Purpose
- / - Outer Space
- AC- 90% Shield Coverage

Basic Specification Number

- 1 - Normal Stranding
- 2 - High Stranding

* Shield coating same as conductor coating except for the following:
 - shield for conductor type 4 shall be tin-coated copper
 - round braid shield constructions for conductor type 6 shall be nickel-coated copper
 - flat braid shield constructions for conductor type 6 shall be tin-coated copper
 Other shield variations are designated as Special Constructions

Halogen-Free, Fire Resistant Cable Range

Product Facts

- Highly flame retardant
- Halogen-free
- Low smoke generation
- Low toxicity index
- Low acid gas emission
- Low water uptake
- Compatible with Raychem System 100 heat-shrink components, heat-shrink tubing, molded parts and adhesives

FR-1000

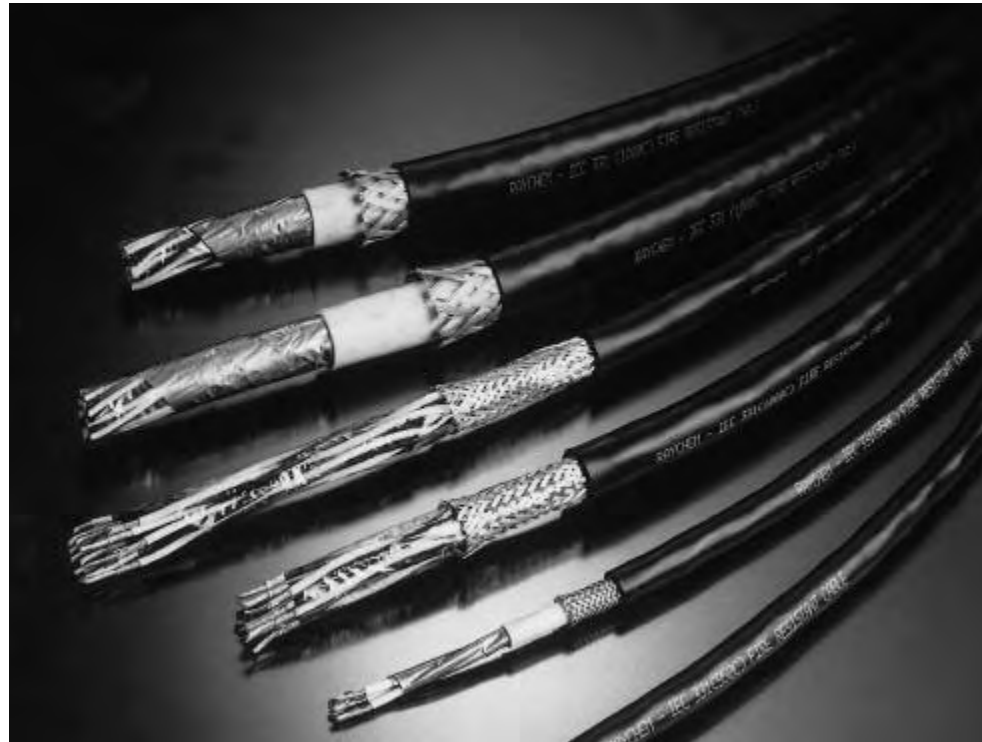

Applications

Tyco Electronics has developed a new halogen-free, lightweight, small size, fire resistant Raychem cable to exceed the exacting fire resistant requirements of IEC 60331 (ie withstands 950°C [1742°F] for 3 hours as opposed to the 750°C [1382°F] requirement) and meet the flame-retardant requirements of IEC 60332-3 (Cat A), while maintaining significant size and weight savings over conventional materials.

FR-1000 cable consists of Raychem Type 95 primary wire with a Zerohal jacket and can be used throughout the installation, simplifying the selection for designers and electrical engineers. By a combination of our proven expertise in polymer and radiation chemistry, low fire hazard technology and precision extrusion capability,

Tyco Electronics has been able to develop a range of Raychem cables featuring reduced size and weight over existing thickwall cables. This offers savings of approximately 30% and optimizes the space available. This results in lower installed costs by downsizing connectors, glanding, cable support structures, and reduced time on installation.

With increasing complexity of electronic systems, sensors, communications and safety equipment, more cables are required to fit into smaller spaces. FR-1000 small size cable can offer distinct advantages over conventional cables.

These include:

- Tough and flexible constructions aiding installation through smaller bend radii and extending service life.
- Controlled dimensions simplifying connector and transit selection.
- Resistance to widely used fluids such as diesel fuels, oils, and greases.

Operating Temperature Range

-30°C to +90°C
[-22°F to +194°F]

Available in:	Americas	Europe	Asia Pacific
	■	■	■

Generic Cable Construction

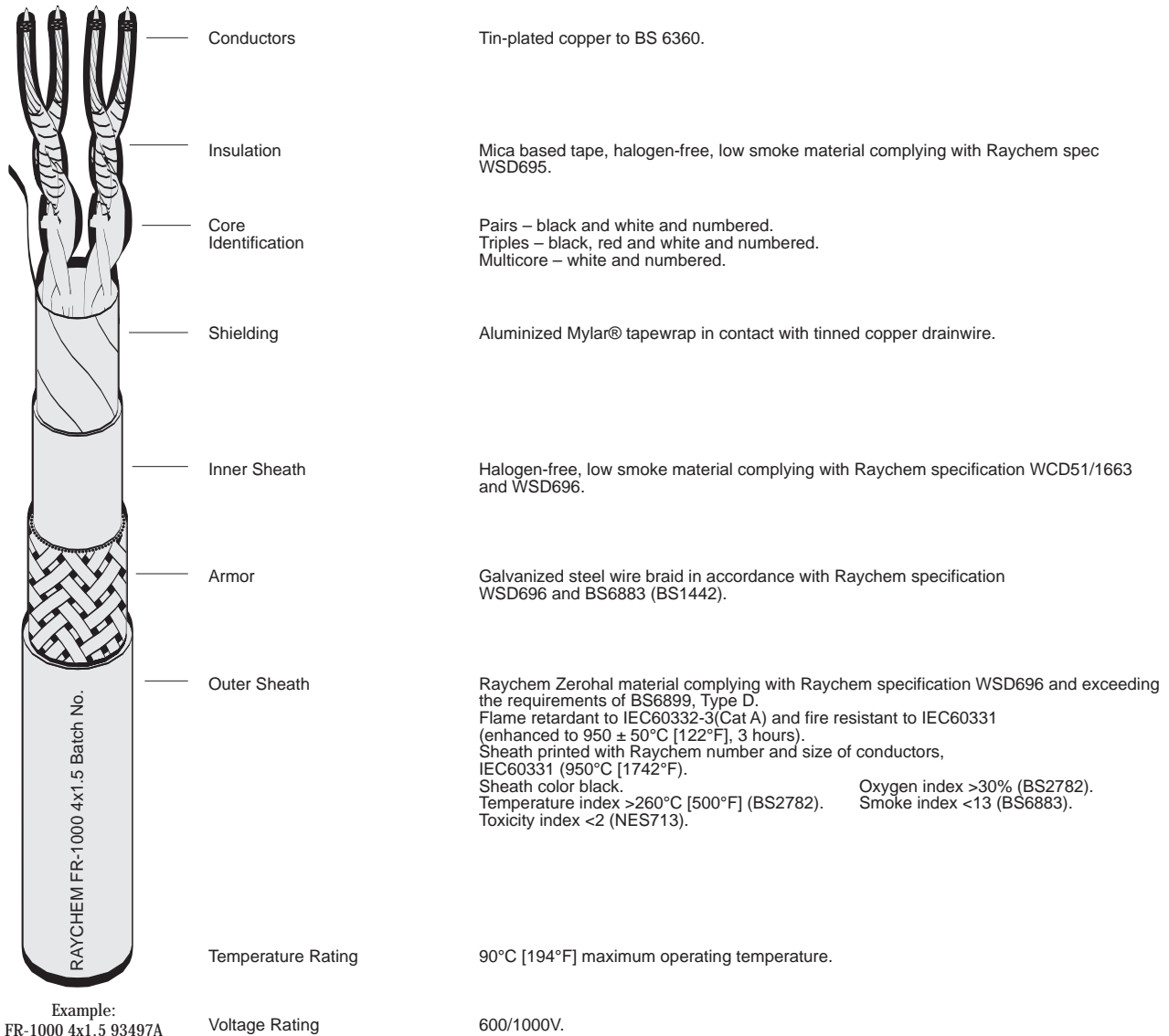

MYLAR is a trademark of Dupont Teijin Films U.S.

Halogen-Free, Fire Resistant Cable Range

FR-1000 (Continued)

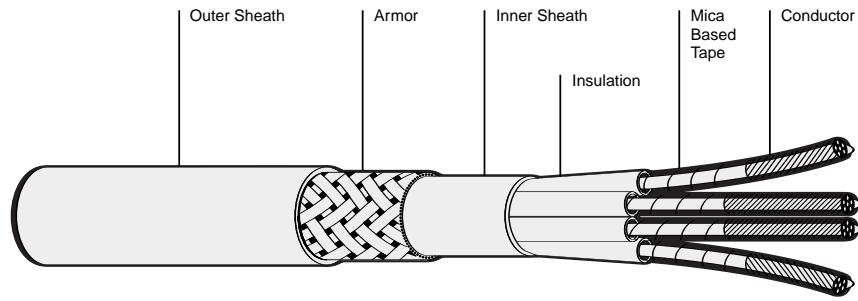

FR-1000 Multicore Control Cables, Unshielded, Armored, 600/1000V*

Selection Table

Part No. EPD	Construction	Conductor Stranding	CSA Nominal mm ²	Diameter Over Inner Sheath	Cable		Nominal Weight kg/km	Jacket Color
					Outer Diameter			
					(min.)	(max.)		
87486A	2x1.5	19/0.32	1.5	6.6 [.260]	10.2 [.402]	11.2 [.441]	178	Black
87488A	3x1.5	19/0.32	1.5	7.1 [.280]	10.8 [.425]	11.6 [.457]	203	Black
87490A	4x1.5	19/0.32	1.5	7.7 [.303]	11.2 [.441]	12.4 [.488]	236	Black
87492A	7x1.5	19/0.32	1.5	9.4 [.370]	13.0 [.512]	14.4 [.567]	328	Black
87494A	12x1.5	19/0.32	1.5	12.5 [.492]	16.0 [.630]	17.6 [.693]	486	Black
87496A	19x1.5	19/0.32	1.5	14.7 [.579]	18.2 [.717]	20.2 [.795]	677	Black
87498A	27x1.5	19/0.32	1.5	17.9 [.705]	21.3 [.839]	23.5 [.925]	906	Black
87487A	2x2.5	7/0.67	2.5	7.7 [.303]	11.2 [.441]	12.4 [.488]	224	Black
87489A	3x2.5	7/0.67	2.5	8.2 [.323]	11.7 [.461]	12.9 [.508]	257	Black
87491A	4x2.5	7/0.67	2.5	9.0 [.354]	12.6 [.496]	14.0 [.551]	312	Black
87493A	7x2.5	7/0.67	2.5	10.9 [.429]	14.7 [.579]	15.7 [.618]	429	Black
87495A	12x2.5	7/0.67	2.5	14.6 [.575]	18.1 [.713]	20.1 [.791]	661	Black
87497A	19x2.5	7/0.67	2.5	17.5 [.689]	20.9 [.823]	23.1 [.909]	936	Black
87499A	27x2.5	7/0.67	2.5	21.1 [.831]	25.3 [.996]	27.3 [1.075]	1321	Black

*Cables are armored with an overall galvanized steel wire braid armor.

FR-1000 (Continued)

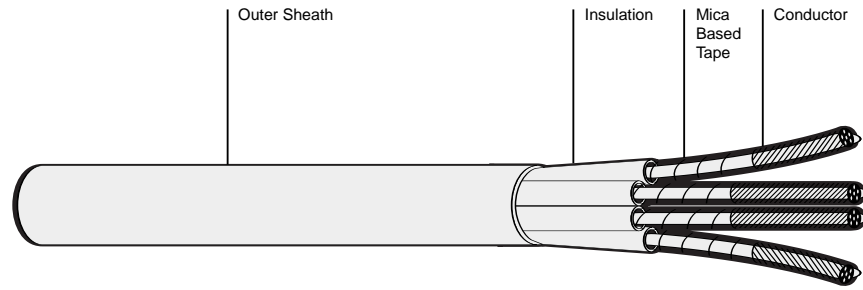

FR-1000 Multicore Control Cables, Unshielded, Unarmored, 600/1000V

Selection Table

Part No. EPD	Construction	Conductor Stranding	CSA Nominal mm ²	Outer Diameter		Cable Nominal Weight kg/km	Jacket Color
				(min.)	(max.)		
				87472A	2x1.5		
87474A	3x1.5	19/0.32	1.5	7.8 [.307]	8.6 [.339]	108	Black
87476A	4x1.5	19/0.32	1.5	8.4 [.331]	9.2 [.362]	134	Black
87478A	7x1.5	19/0.32	1.5	10.1 [.398]	11.1 [.437]	204	Black
87480A	12x1.5	19/0.32	1.5	13.3 [.524]	14.3 [.563]	332	Black
87482A	19x1.5	19/0.32	1.5	15.2 [.598]	16.8 [.661]	490	Black
87484A	27x1.5	19/0.32	1.5	18.5 [.728]	19.9 [.783]	684	Black
87473A	2x2.5	7/0.67	2.5	8.4 [.331]	9.2 [.362]	122	Black
87475A	3x2.5	7/0.67	2.5	8.8 [.346]	9.8 [.386]	150	Black
87477A	4x2.5	7/0.67	2.5	9.7 [.382]	10.7 [.421]	192	Black
87479A	7x2.5	7/0.67	2.5	11.5 [.453]	12.7 [.500]	288	Black
87481A	12x2.5	7/0.67	2.5	15.1 [.594]	16.7 [.657]	475	Black
87483A	19x2.5	7/0.67	2.5	17.9 [.705]	19.7 [.776]	720	Black
87485A	27x2.5	7/0.67	2.5	21.3 [.839]	23.5 [.925]	995	Black

Conductors	Tin plated copper to BS6360
Insulation	Mica based tape, halogen-free, low smoke material complying with Raychem specification WSD695
Core Identification	White and numbered
Inner Sheath	Halogen-free, low smoke material complying with Raychem specification WCD51/1663 and WSD696
Armor	Galvanized steel wire braid in accordance with Raychem specification WSD696 and BS6883 (BS1442)
Outer Sheath	Raychem Zerohal material complying with Raychem specification WSD696 and exceeding the requirements of BS6899, Type D Flame retardant to IEC60332-3(Cat A) and fire resistant to IEC60331 (enhanced to 950 +/- 50°C [122°F], 3 hours) Sheath printed with number and size of conductors, IEC331, Raychem, voltage rating and EPD number Sheath color black Oxygen index >30% (BS2782), Temperature index > 260°C (BS2782), Smoke index <13 (BS6883) Toxicity Index <2 (NES713)
Temperature Rating	90°C [194°F] maximum conductor operating temperature
Voltage Rating	600/1000V

Halogen-Free, Fire Resistant Cable Range

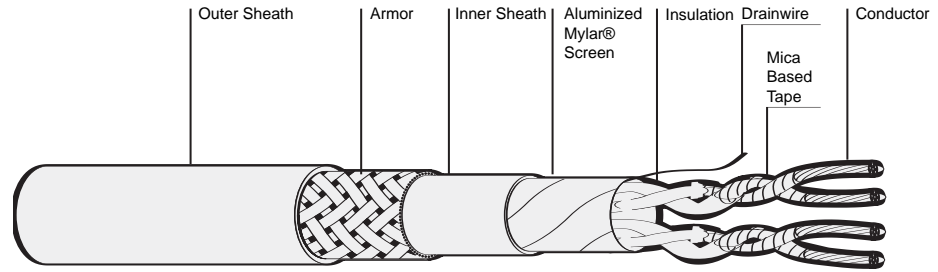

FR-1000 Multipair Control Cables, Collectively Shielded and Armored 600/1000V*

Selection Table

Part No. EPD	Construction	Conductor Stranding	CSA Nominal mm ²	Diameter (Nominal)		Cable			
				Over Shield	Over Inner Sheath	Outer Diameter		Nominal Weight kg/km	Jacket Color
						(min.)	(max.)		
93491A	3x2x0.75	19/0.23	0.75	9.7 [.382]	11.1 [.437]	14.6 [.575]	16.2 [.638]	319	Grey
93492A	7x2x0.75	19/0.23	0.75	13.1 [.516]	14.6 [.575]	18.1 [.713]	20.1 [.791]	484	Grey
93493A	12x2x0.75	19/0.23	0.75	16.4 [.646]	18.1 [.713]	21.5 [.846]	23.7 [.933]	685	Grey
93494A	20x2x0.75	19/0.23	0.75	21.2 [.835]	23.0 [.906]	26.8 [1.055]	29.6 [1.165]	1090	Grey
87500A	2x1.5	19/0.32	1.5	5.4 [.213]	6.7 [.264]	10.7 [.421]	11.3 [.445]	192	Black
87501A	2x2x1.5	19/0.32	1.5	7.2 [.283]	8.6 [.339]	12.3 [.484]	13.5 [.531]	267	Black
87502A	3x2x1.5	19/0.32	1.5	11.2 [.441]	12.7 [.500]	16.1 [.634]	17.9 [.705]	404	Black
87503A	5x2x1.5	19/0.32	1.5	13.8 [.543]	15.3 [.602]	18.8 [.740]	20.8 [.819]	541	Black
87504A	7x2x1.5	19/0.32	1.5	15.2 [.598]	16.9 [.665]	20.3 [.799]	22.5 [.886]	649	Black
87505A	10x2x1.5	19/0.32	1.5	17.5 [.705]	19.2 [.756]	22.5 [.886]	24.9 [.980]	817	Black
87506A	12x2x1.5	19/0.32	1.5	19.0 [.748]	20.7 [.815]	25.2 [.992]	26.6 [1.047]	999	Black
87507A	20x2x1.5	19/0.32	1.5	24.7 [.972]	26.5 [1.043]	30.5 [1.201]	33.7 [1.327]	1541	Black
87508A	24x2x1.5	19/0.32	1.5	26.6 [1.047]	28.6 [1.126]	33.6 [1.323]	35.6 [1.402]	1762	Black

*Cables have an overall aluminized Mylar® shield with drainwire and an overall galvanized steel wire braid armor.

MYLAR is a trademark of Dupont Teijin Films U.S.

FR-1000 (Continued)

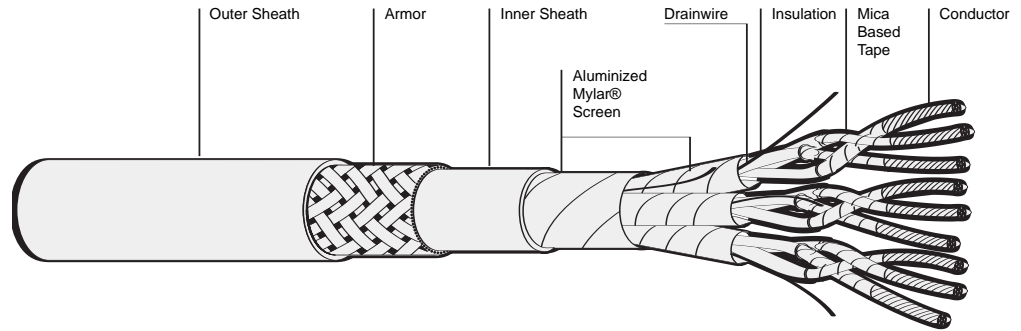

FR-1000 Multitrip control cables,
Collectively Shielded and Armored, 600/1000V*

Selection Table

Part No. EPD	Construction	Conductor Stranding	CSA Nominal mm²	Diameter (Nominal)		Cable			Jacket Color
				Over Shield	Over Inner Sheath	Outer Diameter		Nominal Weight kg/km	
						(min.)	(max.)		
87509A	1x3x1.5	19/0.32	1.5	5.9 [.232]	7.2 [.283]	10.7 [.421]	11.9 [.469]	216	Black
87510A	3x3x1.5	19/0.32	1.5	12.0 [.472]	13.5 [.531]	16.9 [.665]	18.7 [.736]	480	Black
87511A	7x3x1.5	19/0.32	1.5	16.2 [.638]	17.9 [.705]	21.3 [.839]	23.5 [.925]	815	Black
87512A	12x3x1.5	19/0.32	1.5	22.2 [.874]	24.0 [.945]	28.1 [1.106]	31.1 [1.224]	1357	Black

*Cables have an overall aluminumized Mylar® shield with drainwire and an overall galvanized steel wire braid armor.

Conductors	Tin plated copper to BS6360
Insulation	Mica based tape, halogen-free, low smoke material complying with Raychem specification WSD695
Core Identification	Pairs – black and white and numbered. Triples – black, red and white and numbered
Shielding	Aluminumized Mylar® tapewrap in contact with tinned copper drainwire
Inner Sheath	Halogen-free, low smoke material complying with Raychem specification WCD51/1663 and WCD696
Armor	Galvanized steel wire braid in accordance with Raychem specification WSD696 and BS6883 (BS1442)
Outer Sheath	Raychem Zerohal material complying with Raychem specification WSD696 and exceeding the requirements of BS6899, Type D. Flame retardant to IEC60332-3(Cat A) and fire resistant to IEC60331 (enhanced to 950 +/- 50°C [122°F]z, 3 hours) Sheath printed with number and size of conductors, IEC331, Raychem, voltage rating and EPD number Sheath color black Oxygen index >30% (BS2782), Temperature index > 260°C [482°F] (BS2782), Smoke index <13 (BS6883) Toxicity Index <2 (NES713)
Temperature Rating	90°C maximum conductor operating temperature
Voltage Rating	600/1000V

MYLAR is a trademark of
Dupont Teijin Films U.S.

Halogen-Free, Fire Resistant Cable Range

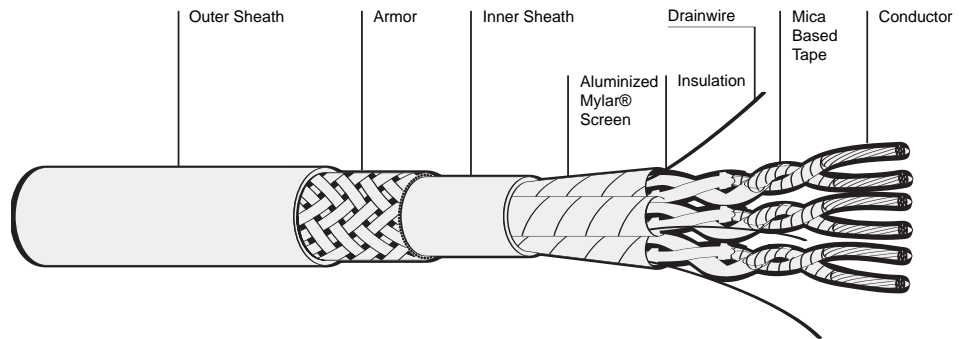

FR-1000 Multipair Control Cables, Collectively Shielded and Armored 600/1000V*

Selection Table

Part No. EPD	Construction	Conductor Stranding	CSA Nominal mm ²	Diameter (Nominal)		Cable			
				Over Shield	Over Inner Sheath	Outer Diameter		Nominal Weight kg/km	Jacket Color
						(min.)	(max.)		
93491A	3x2x0.75	19/0.23	0.75	9.7 [.382]	11.1 [.437]	14.6 [.575]	16.2 [.638]	319	Grey
93492A	7x2x0.75	19/0.23	0.75	13.1 [.516]	14.6 [.575]	18.1 [.713]	20.1 [.791]	484	Grey
93493A	12x2x0.75	19/0.23	0.75	16.4 [.646]	18.1 [.713]	21.5 [.846]	23.7 [.933]	685	Grey
93494A	20x2x0.75	19/0.23	0.75	21.2 [.835]	23.0 [.906]	26.8 [1.055]	29.6 [1.165]	1090	Grey
87500A	2x1.5	19/0.32	1.5	5.4 [.213]	6.7 [.264]	10.7 [.421]	11.3 [.445]	192	Black
87501A	2x2x1.5	19/0.32	1.5	7.2 [.283]	8.6 [.339]	12.3 [.484]	13.5 [.531]	267	Black
87502A	3x2x1.5	19/0.32	1.5	11.2 [.441]	12.7 [.500]	16.1 [.634]	17.9 [.705]	404	Black
87503A	5x2x1.5	19/0.32	1.5	13.8 [.543]	15.3 [.602]	18.8 [.740]	20.8 [.819]	541	Black
87504A	7x2x1.5	19/0.32	1.5	15.2 [.598]	16.9 [.665]	20.3 [.799]	22.5 [.886]	649	Black
87505A	10x2x1.5	19/0.32	1.5	17.5 [.689]	19.2 [.756]	22.5 [.886]	24.9 [.980]	817	Black
87506A	12x2x1.5	19/0.32	1.5	19.0 [.748]	20.7 [.815]	25.2 [.992]	26.6 [1.047]	999	Black
87507A	20x2x1.5	19/0.32	1.5	24.7 [.972]	26.5 [1.043]	30.5 [1.201]	33.7 [1.327]	1541	Black
87508A	24x2x1.5	19/0.32	1.5	26.6 [1.047]	28.6 [1.126]	33.6 [1.323]	35.6 [1.402]	1762	Black

*Cables have an overall aluminized Mylar® shield with drainwire and an overall galvanized steel wire braid armor.

MYLAR is a trademark of Dupont Teijin Films U.S.

FR-1000 (Continued)

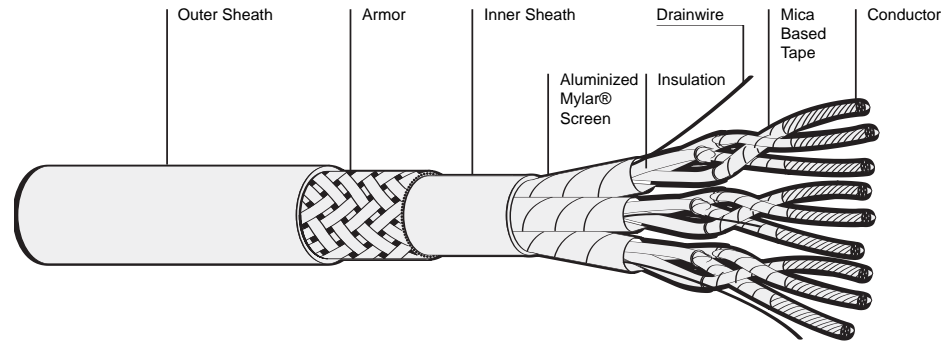

FR-1000 Multitriples Control Cables,
Individually Shielded, Armored,
600/1000V*

Selection Table

Part No. EPD	Construction	Conductor Stranding	CSA Nominal mm ²	Diameter (Nominal) Over Inner Sheath	Cable				Jacket Color
					Outer Diameter		Nominal Weight kg/km		
					(min.)	(max.)			
93500A	3x3x0.75	19/0.23	0.75	12.4 [.488]	15.9 [.626]	17.5 [.689]	407	Grey	
93501A	7x3x0.75	19/0.23	0.75	16.8 [.661]	20.2 [.795]	22.4 [.881]	682	Grey	
93502A	12x3x0.75	19/0.23	0.75	22.6 [.890]	26.4 [1.039]	29.2 [1.150]	1111	Grey	
93503A	3x1.00	19/0.25	1.0	6.6 [.260]	10.6 [.417]	11.6 [.457]	198	Grey	

*Cables have pairs individually shielded with aluminumized Mylar® and drainwire and an overall galvanized steel wire braid armor.

Conductors	Tin plated copper to BS6360
Insulation	Mica based tape, halogen-free, low smoke material complying with Raychem specification WSD695
Core Identification	Pairs – black and white and numbered. Triples – black, red and white and numbered
Shielding	Aluminumized Mylar® tapewrap in contact with tinned copper drainwire
Inner Sheath	Halogen-free, low smoke material complying with Raychem specification WCD51/1663 and WSD696
Armor	Galvanized steel wire braid in accordance with Raychem specification WSD696 and BS6883 (BS1442)
Outer Sheath	Raychem Zerohal material complying with Raychem specification WSD696 and exceeding the requirements of BS6899, Type D. Flame retardant to IEC60332-3(Cat A) and fire resistant to IEC60331 (enhanced to 950 +/- 50°C [122°F], 3 hours) Sheath printed with number and size of conductors, IEC331, Raychem, voltage rating and EPD number Sheath color black Oxygen index >30% (BS2782), Temperature index > 260°C [500°F] (BS2782), Smoke index <13 (BS6883) Toxicity Index <2 (NES713)
Temperature Rating	90°C [194°F] maximum conductor operating temperature
Voltage Rating	600/1000V

MYLAR is a trademark of
Dupont Teijin Films U.S.

Type 99M

Product Facts

- Low flammability
- Low smoke generation
- Low toxicity index
- Low generation of corrosive gases
- Small size, lightweight



Applications

Type 99M wire has a dual wall construction of radiation cross-linked modified polyester. This combines excellent mechanical performance and chemical resistance with a range of enhanced fire hazard properties. Type 99M wire is designed to meet the stringent low fire hazard performance now being specified by many authorities, in particular for naval, mass transit and industrial control panel wiring.

During the 1980's there were major changes in the demands of many wire and cable specifications to reduce the risks associated with all aspects of fire

hazards. Specifications such as Def Stan 61-12 Part 18, have been developed over the last decade demanding improved performance of wires and cables under fire conditions.

This has led to a tightening of the requirements for flammability, smoke generation, corrosive gas generation and hazardous fume emission. Type 99M wire achieves these improvements in performance whilst retaining small size, light weight, flexibility, handleability, resistance to carbon arc tracking and resistance to chemicals and fluids.

Physical Characteristics

Handleability

Type 99M wire has been designed to be compatible with modern wiring and harnessing techniques. It is a flexible wire with virtually no springback once set. It is easily stripped with tools such as conventional die-blade strippers.

Small Size

Type 99M equipment wire has a nominal 0.2 mm insulation wall thickness which is comparable to other established thin wall wires such as SPEC 44 wire.

Light Weight

Type 99M wire is designed to have the same weights as SPEC 44 wire.

Available in:	Americas	Europe	Asia Pacific
	■	■	■

Approvals

Type 99M (Continued)

Raychem WCD 281

Def Stan 61-12 Part 18 Issue 4 Type 1

Italian Navy STN-SR-01

Lloyds Register

Type 99M Wire and Cable -
Nominal Sizes, Strandings
and Weights



99M011X (600 V)
Primary Wire



99M021X (1000 V)
Primary Wire



99M1111
Shielded & Jacketed



99M1121
Shielded & Jacketed

Primary Wires/Shielded and
Jacketed Cables - 99M

Size	Stranding (mm)	99M011X (600 V)		99M021X (1000 V)		99M1111		99M1121	
		OD	Weight (g/m)	OD	Weight (g/m)	OD	Weight (g/m)	OD	Weight (g/m)
26	19x0.10	0.88 [.035]	2.00	1.01 [.040]	2.2	1.80 [.071]	7.5	2.91 [.115]	13.3
24	19x0.12	0.98 [.039]	3.00	1.17 [.046]	3.4	1.90 [.075]	9.2	3.20 [.126]	16.6
22	19x0.15	1.13 [.044]	4.40	1.37 [.054]	4.9	2.05 [.081]	11.1	3.52 [.139]	20.5
20	19x0.20	1.40 [.055]	6.50	1.57 [.062]	7.3	2.30 [.091]	14.6	4.02 [.158]	27.7
18	19x0.25	1.65 [.065]	9.90	1.85 [.073]	10.9	2.55 [.100]	19.3	4.57 [.180]	37.1
16	19x0.30	1.90 [.075]	14.15	2.10 [.083]	14.5	2.95 [.116]	24.9	5.13 [.202]	48.5
14	37x0.25	2.25 [.089]	18.62	2.50 [.098]	21.8	3.13 [.123]	30.9	5.72 [.225]	60.5
12	37x0.32	2.60 [.102]	25.70	2.97 [.117]	31.3	3.48 [.137]	43.4	6.42 [.253]	86.0

Typical Properties

Test	Method	Typical value
Temperature rating	BS G230	125°C [257°F]
Voltage rating	Raychem	600 V thin wall
Tensile strength/elongation of insulation	—	30 MPa/250%
Notch propagation (0.05 mm notch)	BS G230	Pass
Shrinkage 200°C [392°F]	BS G230	<1%
Low temperature bend	BS G230	-55°C [-67°F]
Voltage withstand	BS G230	2.5 kV
Insulation resistance (20°C [68°F])	BS G230	1000 M ohms km (min)
Pliability rating	Def Stan 61-12 (18)	82 - Pliable
Fluid resistance	Def Stan 61-12 (18)	
Fuels - aircraft		Pass
Oils - (ASTM No 3)		Pass
Solvents		Pass

Type 99M (Continued)

Environmental Properties

Mechanical Performance

The scrape abrasion and cut through resistance of Type 99M wire out performs the well-established performance of SPEC 44 wire throughout its operating temperature range.

Fluid Resistance

Type 99M wire demonstrates outstanding resistance to most acids, alkalis, hydrocarbon solvents, fuels, lubricants and water.

Electrical Arc Tracking

Type 99M wire is resistant to electrical arc tracking under both wet and dry conditions.

Voltage Ratings

Standard available voltage ratings for Type 99M wire are 600 V (0.2 mm wall thickness) and 1000 V (0.3 mm wall thickness).

Fire Hazard Characteristics

Low Toxicity Index

Type 99M wire is designed to meet the low hazardous fume emission levels required in modern specifications. For example, the change in the Toxicity Index requirement from 1.5 to 0.2 between Issue 2 and Issue 3 of Def Stan 61-12 (Part 18), is met by Type 99M wire.

Flammability

Type 99M wire has passed some of the most stringent flammability tests, such as the test in IEC 332 Part 3 (ladder test) and Underwriter's Laboratory for VW1 (individual wire)

Smoke Generation

Type 99M wire has been designed to meet stringent smoke tests such as those specified in Def Stan 61-12 (Part 18) and in many mass transit specifications.

Corrosivity

Type 99M wire has a low corrosive gas emission, demonstrated by its low acid gas value and meets the latest requirements of low fire hazard specifications.

Fire Hazard Properties

Test	Method	Typical value
Flammability	IEC 332 Pt 3	Pass
Toxicity index	Def Stan 61-12 (18)	0.1 per meter of wire
Smoke index	Def Stan 61-12 (18)	8 per meter of wire
Acid gas equivalent	TDE 76/P/76	<1.5%

Part Numbering System

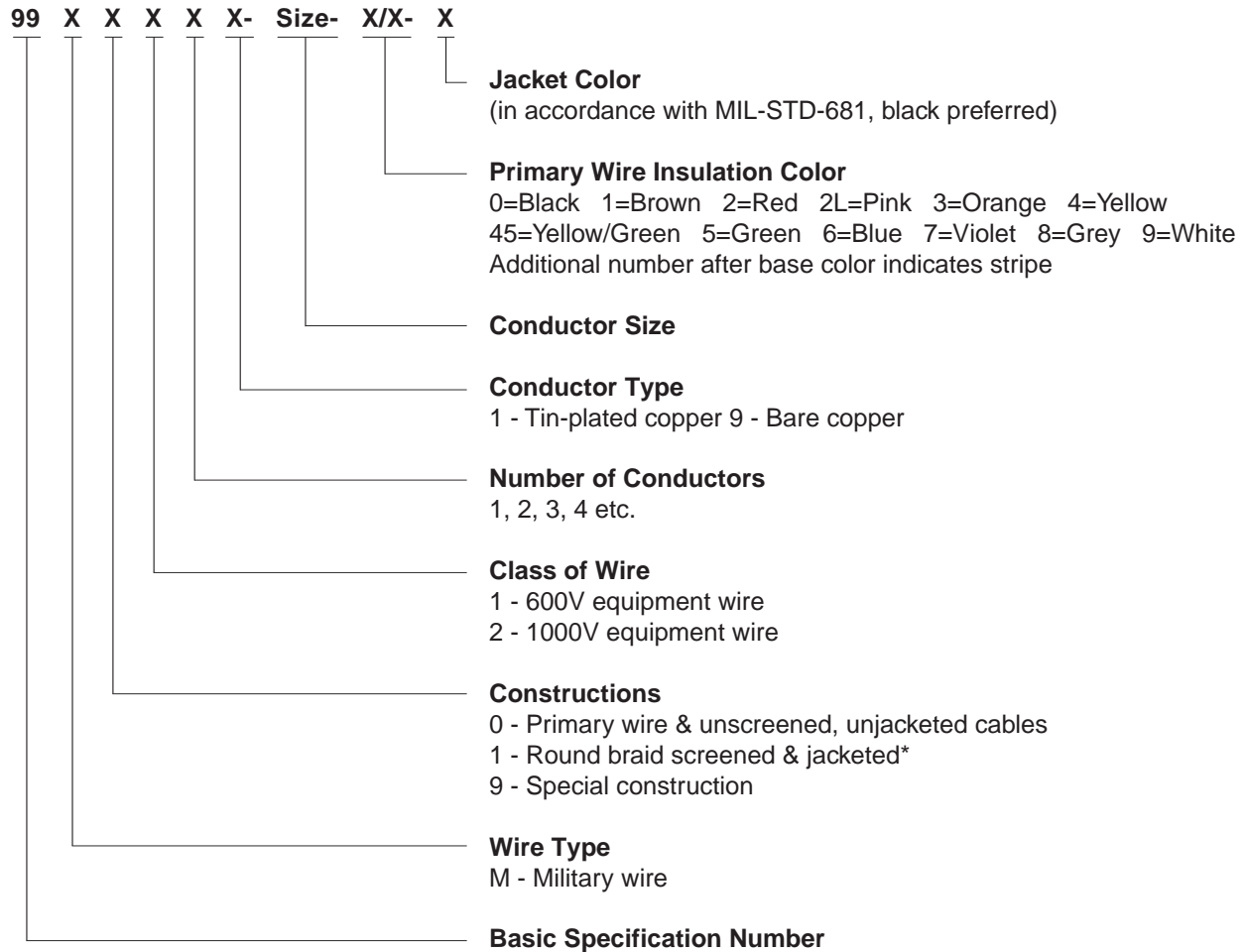

* The cable jackets are Raychem Zerohal and the preferred color is black.

Zerohal 100A

Product Facts

- Halogen free, low smoke
- Highly flame retardant
- Flexible, easy to install
- Small size, lightweight (thin wall construction)



Applications

Raychem's latest generation LFH, thinwall wire has been designed for use primarily in signal, control and light power circuits in subway, regional and high speed trains. It is ideal for applications where space and weight are at a premium; fire safety is important; reliability is imperative; rugged properties to withstand service in an RMT environment are required.

The construction is a dual wall combination of Raychem formulated polymer blends developed to meet the specification requirements while maintaining the desirable features of small size, lightweight, flexibility, non-wrinkling, ease of stripping,

compatibility with standard stripping equipment, lack of recoil and mechanical robustness.

Physical Characteristics

Handleability

Zerohal 100A has been designed for minimum recoil during harnessing operations, to be readily handleable by modern wiring and harnessing techniques and to be easily stripped with standard equipment and tools.

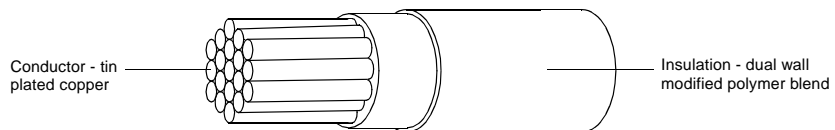

Available in:	Americas	Europe	Asia Pacific
	■	■	■

Typical Properties

Test	Method	Typical Values			
Physical Properties					
Insulation Tensile Strength and Ultimate Elongation	ASTM D3032	Tensile Strength 3500 psi minimum Ultimate Elongation 250% minimum			
Scrape Abrasion Resistance	AAR S 501	1000 cycles minimum (90°, 0.01 inch radial edge blade, 6N load, 20°C [68°F])			
Dynamic Cut Through	ASTM D3032	20 lbs. minimum (90°, 0.01 inch radial edge blade, 0.2 inch per min, 20°C [68°F])			
Static Cut-through Penetration	AAR S 501	No contact with the conductor (90°, 0.01 inch radial edge blade, 10 min, 9N load, 125°C [257°F])			
Thermal Properties					
Temperature Index	ASTM D3032	10,000 hours minimum at 125°C [257°F]			
Accelerated ageing	ASTM D3032	No cracks, flow or dielectric breakdown. (168hr at 170°C [338°F])			
Shrinkage	IEC 811-1-3	0.5% maximum at each end. (6hr at 160°C [320°F])			
Insulation Blocking	MIL-W-22759E	Cores must be easily separated without damage (24hr at 125°C [257°F], 6X mandrel.)			
Electrical Properties					
IR Constant	ASTM D3032	>10000 MΩkft at 20°C [68°F] >100 MΩkft at 60°C [140°F] >10 MΩkft at 90°C [194°F]			
Environmental Properties					
Fluid Immersion	ASTM D3032	Fluid	NATO code	Temp (°C)	Time (hr)
		ASTM No. 1 Oil	—	100	70
		IRM 902 Oil	—	100	70
		IRM 903 Oil	—	100	70
		70/30 iso-octane/toluene	—	23	24
		Engine lubricating oil	O-236	70	24
		Grease	G-354	70	24
		Hydraulic fluid, petroleum base	H-515	50	24
		Silicone damping fluid	S-1724	70	24
		Automotive brake fluid	H-542	23	24
		Fire resistant hydraulic fluid	H-544	50	24
		De-icing fluid	S-745	23	24
Methyl Ethyl Ketone	—	23	1		
5% max swell. No dielectric breakdown. (30mm diameter mandrel)					
Fire Hazard Properties					
Flammability - small scale	IEC 332-1	Charring confined between 50mm and 540mm from lower edge of top support. (Single vertical wire, 60 s flame)			
Flammability - large scale	IEC 332-3	2.5m maximum burn length. (Five 3.5m long 37-wire bundles, vertical, 20.5 kW flame)			
Smoke - small scale	ISO 5659-2	Ds1.5 of 100 max., Ds4 of 150 max., Dmax of 150 max., VOF4 of 300 max. (‘NBS’ smoke box with cone heater, 1.8m of wire 50 kW/m2 heat flux with and without a pilot flame)			
Smoke - large scale	IEC 1034	90% minimum transmittance. (3m cube smoke box. Eight 1m long 7-wire bundles, horizontal. Fire source: 1 litre burning alcohol.)			
Toxicity	IMO FTPC	Toxicity index < 1 (Test conditions as in smoke - small scale)			
Halogen Content	IEC 684-2	Less than 0.2% Cl + Br + I. Less than 0.1% F (Wet chemical analysis)			
Copper Mirror Corrosion	ASTM D2671	5% maximum etched area. (0.4g sample, 200°C [392°F], 16hr.)			
Acid Gas Detection	IEC 754-2	pH greater than 4.3 10 μS/mm maximum (1g sample, tube furnace, T > 935°C [1715°F], gases dissolved in water)			

Ordering Information

Conductor		Diameter		Finished Wire Maximum Resistance at 20°C /kft/km	Diameter		Maximum Weight lbs/kft kg/km	Part No.
Wire Size AWG	Stranding No x AWG Dia (mm)	Min.	Max.		Min.	Max.		
24	19x36	0.550 [0.022]	0.63 [0.025]	25.7 [84.32]	1.09 [0.043]	1.19 [0.047]	2.41 [3.59]	100A0111-24-*
22	19x34	0.735 [0.029]	0.79 [0.031]	15.9 [52.2]	1.26 [0.050]	1.33 [0.052]	3.34 [4.98]	100A0111-22*
20	19x32	0.940 [0.037]	1.01 [0.040]	9.9 [32.4]	1.46 [0.057]	1.54 [0.061]	4.98 [7.42]	100A0111-20*
18	19x30	1.170 [0.046]	1.26 [0.050]	6.2 [20.4]	1.69 [0.067]	1.79 [0.071]	7.31 [10.89]	100A0111-18*
16	19x29	1.321 [0.052]	1.37 [0.054]	4.8 [15.8]	1.84 [0.072]	1.94 [0.076]	9.19 [13.70]	100A0111-16*
14	19x27	1.650 [0.065]	1.79 [0.070]	3.1 [10.0]	2.27 [0.089]	2.39 [0.094]	14.45 [21.53]	100A0111-14*
12	37x28	2.080 [0.082]	2.24 [0.088]	2.0 [6.63]	2.71 [0.107]	2.86 [0.113]	21.03 [31.33]	100A0111-12*
10	37x26	2.690 [0.106]	2.83 [0.111]	1.3 [4.13]	3.33 [0.131]	3.51 [0.138]	33.27 [49.58]	100A0111-10*

Zerohal 100A (Continued)

Environmental Properties

Fluid Resistance

Zerohal 100A wire demonstrates an outstanding balance of resistance to a wide range of commonly used solvents, fluids and lubricants.

Voltage Rating

Zerohal 100A wire is a 600 volt rated wire.

Fire Hazard Characteristics

Zerohal 100A is a halogen free insulation system and does not contain phosphorus or sulphur. It meets the toxicity, smoke density, halogen content, corrosivity and flammability requirements of major recognized agencies.

Flammability

Zerohal 100A meets the flammability/burning behavior requirements of major recognized agencies.

Fire Hazard Properties

Test	Method	Typical Value
Flammability - small scale	IEC 332-1	Charring confined between 50mm and 540mm from lower edge of top support. (Single vertical wire, 60 s flame)
Flammability - large scale	IEC 332-3	2.5m maximum burn length. (Five 3.5m long 37-wire bundles, vertical, 20.5 kW flame)
Flammability	IEEE 383	Pass
Smoke - small scale	ISO 5659-2	Ds1.5 of 100 max., Ds4 of 150 max., Dmax of 150 max., VOF4 of 300 max. ('NBS' smoke box with cone heater, 1.8m of wire 50 kW/m ² heat flux with and without a pilot flame)
Smoke - small scale	ASTM E662	Smoke density - Ds4 (Max.) Flaming - 200 Non-Flaming - 75
Toxicity	IMO FTPC	Toxicity index < 1 (Test conditions as in smoke - small scale)
Halogen Content	IEC 684-2	Less than 0.2% Cl + Br + I. Less than 0.1% F (Wet chemical analysis)
Copper Mirror Corrosion	ASTM D2671	5% maximum etched area. (0.4g sample, 200°C [392°F], 16hr.)
Acid Gas Detection	IEC 754-2	pH greater than 4.3 10 µS/mm maximum (1g sample, tube furnace, T > 935°C [715°F], gases dissolved in water)

Part Numbering System

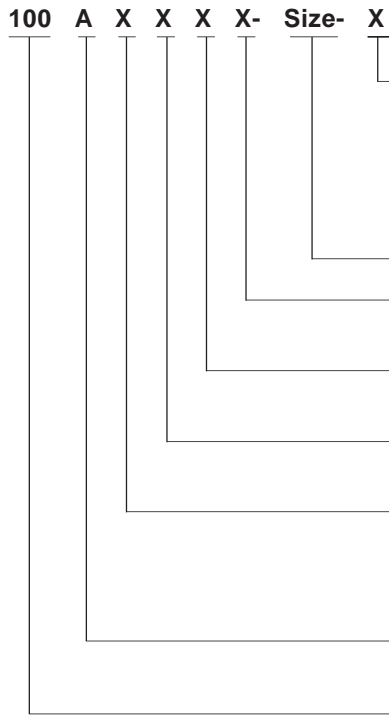

Primary Wire Insulation Color

- 0 - Black
- 1 - Brown
- 2 - Red
- 3 - Orange
- 4 - Yellow
- 5 - Green
- 6 - Blue
- 7 - Violet
- 8 - Gray
- 9 - White

Conductor Size

Conductor Type

- 1 - Tin-plated copper

Number of Conductors

- 1 to 9

Class of Wire

- 1 - 600 V equipment wire

Construction

- 0 - Primary wire and unscreened, unjacketed cables
- 1 - Roundbraid, screened and jacketed
- 4 - Jacketed, no screen

Wire Type

- A - AWG construction (US Specification)

Basic Specification Number

Zerohal 100G

Product Facts

- Qualified to VG 95218-20, Type E
- Halogen free, low smoke
- Highly flame retardant
- Flexible, easy to install
- Small size, lightweight (thin wall construction)



Applications

Zerohal 100G wire has been developed to meet the requirements of German Specification VG 95218-20, Type E primary wire.

The construction is a dual wall combination of Raychem formulated polymer blends developed to meet the specification requirements while maintaining the desirable features of small size, light-weight, flexibility, non-wrinkling, ease of stripping, compatibility with standard stripping equipment, lack of recoil and mechanical robustness.

System

- System 100

Physical Characteristics

Handleability

Zerohal 100G wire has been designed for minimum recoil during harnessing operations, to be readily handleable by modern wiring and harnessing techniques and to be easily stripped with standard equipment and tools.

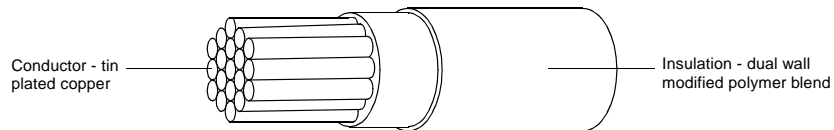

Available in:	Americas	Europe	Asia Pacific
	■	■	■

Approvals

Typical Properties

Zerohal 100G (Continued)

VG 95218-20, Type E (Electrical cables and insulated wires for low frequency - Part 20: Single core insulated wires.)

Test	Method	Typical Value
Max. operating temperature	VG 95218-20, ASTM D 3032	125°C [257°F] (20,000 h)
Insulation shrinkage (160°C)	DIN VDE 0472 Pt 628, IEC 811-1-3	< 0.5%
Low temperature bend	VG 95218 - Pt 2	-55°C [-67 °F]
Pressure test at high temperature	DIN VDE 0472 Pt 609, IEC 811-3-1	125°C [257°F] < 30% indentation
Heat aging (150°C, 6 h) (140°C, 120 h)	DIN VDE 0472 Pt 303, IEC 811-1-2	No cracking, no dielectric breakdown
Voltage rating	VG 95218-20	750/1300 V AC
Abrasion resistance	VG 95218 - Pt 2	Pass
Insulation blocking (125°C)	VG 95218 - Pt 2	Pass
Voltage withstand (23°C, 2.5 kV rms)	DIN VDE 0472 pt 509	Pass
Insulation resistance	DIN VDE 0472 pt 502, IEC 885-1	> 500 M ohms. km (20°C [68°F]) > 0.5 M ohms. km (90°C [194°F])
Chemical resistance		
Grease (G-354)*	VG 95218 - Pt 2, 70°C 24h	< 5% diameter change, no dielectric breakdown
Hydraulic fluid (H-515, H-544)*	VG 95218 - Pt 2, 50°C 24h	< 5% diameter change, no dielectric breakdown
Brake fluid (H-542)*	VG 95218 - Pt 2, 23°C 24h	< 5% diameter change, no dielectric breakdown
De-icing fluid (S-745)*	VG 95218 - Pt 2, 23°C 24h	< 5% diameter change, no dielectric breakdown
MEK	VG 95218 - Pt 2, 23°C 1h	< 5% diameter change, no dielectric breakdown
70/30 ISO-Octane/ Toluene	VG 95218 - Pt 2, 23°C 24h	< 5% diameter change, no dielectric breakdown
Insulation		
Tensile strength	DIN VDE 0472 pt 602, IEC 811-1-1	> 20 MPa
Elongation at break	DIN VDE 0472 pt 602, IEC 811-1-1	> 200%

*NATO code. For further details please consult the German Standard VG 95218-20, Type E.

Part Numbering System

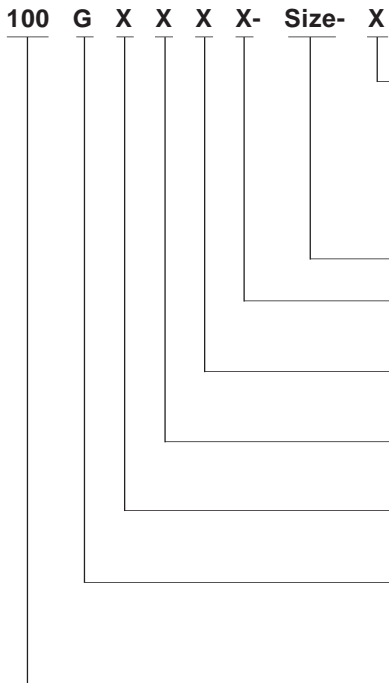

Primary Wire Insulation Color

- 0 - Black
- 1 - Brown
- 2 - Red
- 2L - Pink
- 3 - Orange
- 4 - Yellow
- 5 - Green
- 6 - Blue
- 7 - Violet
- 8 - Gray
- 9 - White

NB. VG 95218 T020-EXXX wire only available in colors 0, 1, 45, 6, 9

Conductor Size

Conductor Type

- 1 - Tin-plated copper

Number of Conductors

- 1

Class of Wire

- 1 - 750 V equipment wire

Construction

- 0 - Primary wire

Wire Type

- G - Meeting the performance requirements of German Specification VG 95218-20, Type E

Basic Specification Number

Zerohal 100G (Continued)

Environmental Properties

Fluid Resistance

Zerohal 100G wire demonstrates an outstanding balance of resistance to a wide range of commonly used solvents, fluids and lubricants.

Voltage Rating

Zerohal 100G wire is a 750/1300 V AC rated wire.

Fire Hazard Characteristics

Zerohal 100G is a halogen free insulation system and does not contain phosphorus or sulphur. It meets the toxicity, smoke density, halogen content, corrosivity and flammability requirements of VG 95218-20, Type E.

Flammability

Zerohal 100G meets the flammability/burning behavior requirements of VG 95218-20, Type E.

Fire Hazard Properties

Test	Method	Typical value
Toxicity	NES 713	3.5
Smoke density	IEC 1034 Pt 1 and 2	95% light transmittance
Halogen content	DIN VDE 0472 pt 815	Non-detected
Corrosivity of combustion gases	DIN VDE 0472 pt 813, IEC 754-2	5.0 pH, <4 µS/mm conductivity
Flammability	VG 95218 Pt 2	< 15 sec afterburn < 150 mm burn length

Ordering Information

Conductor Nominal Cross Sectional Area mm ²	Stranding No x nom Dia (mm)	Diameter		Insulated Wire Maximum Resistance at 20°C ohms/km	Diameter		Maximum Weight g/m	VG 95218 Part No.	Part No.
		min.	max.		min.	max.			
0.40	19x0.16	0.74 [.029]	0.79 [.031]	50.50	1.28 [.050]	1.39 [.055]	5.17	VG 95218 T020-E02*	100G0111-0.40-*
0.50	19x0.18	0.82 [.032]	0.90 [.035]	40.10	1.37 [.054]	1.47 [.058]	6.60	VG 95218 T020-E03*	100G0111-0.50-*
0.60	19x0.20	0.95 [.037]	1.01 [.040]	31.10	1.47 [.058]	1.57 [.062]	7.54	VG 95218 T020-E04*	100G0111-0.60-*
0.75	19x0.23	1.04 [.041]	1.15 [.045]	26.70	1.59 [.063]	1.70 [.067]	8.90	VG 95218 T020-E05*	100G0111-0.75-*
1.00	19x0.25	1.17 [.046]	1.26 [.050]	20.00	1.69 [.067]	1.80 [.071]	10.73	VG 95218 T020-E06*	100G0111-1.00-*
1.20	19x0.29	1.32 [.052]	1.42 [.056]	15.30	1.88 [.074]	1.98 [.078]	13.59	VG 95218 T020-E07*	100G0111-1.20-*
1.50	37x0.23	1.46 [.057]	1.58 [.062]	13.70	2.03 [.080]	2.13 [.084]	15.96	VG 95218 T020-E08*	100G0111-1.50-*
2.00	37x0.25	1.68 [.066]	1.82 [.072]	10.50	2.31 [.091]	2.41 [.095]	20.29	VG 95218 T020-E09*	100G0111-2.00-*
2.50	37x0.29	1.85 [.073]	2.01 [.079]	8.21	2.48 [.098]	2.63 [.104]	25.65	VG 95218 T020-E10*	100G0111-2.50-*
3.00	37x0.32	2.12 [.083]	2.24 [.088]	6.58	2.70 [.106]	2.86 [.113]	31.00	VG 95218 T020-E11*	100G0111-3.00-*
4.00	56x0.30	2.41 [.095]	2.56 [.101]	4.86	3.01 [.119]	3.16 [.124]	43.48	—	100G0111-4.00-*

The VG 95218-20, Type E specification defines that the insulation color shall be black, brown, yellow/green, blue or white only.

To ensure full compliance with the specification, order the VG 95218 part number complete with color code.

Raychem Type 100G wire, meeting the performance requirements of VG 95218-20, Type E, is available in other colors (see part numbering system). To order these colors, order the Raychem 100G part number.

*Color code in accordance with part number system.



Available in:

- Americas ■
- Europe ■
- Asia Pacific ■

FlexLite



Selection Guide

Application	Temperature Rating (°C/°F)	Features and Benefits	Product Name
Intermittent-duty motors and heating elements	-45°C to 125°C -49°F to 257°F	<ul style="list-style-type: none"> ■ Insulation that does not melt and flow at high temperatures ■ Excellent chemical resistance ■ VW-1 	FlexLite DW
Electronics, appliance, and motor applications	-55°C to 135°C -67°F to 275°F	<ul style="list-style-type: none"> ■ Small size, light weight ■ No plasticizers or corrosive outgassing ■ Good mechanical and shop handling characteristics 	FlexLite TW
General purpose appliance wire	-55°C to 150°C -67°F to 302°F	<ul style="list-style-type: none"> ■ VW-1 ■ Excellent chemical resistance ■ Insulation does not melt and flow at high temperature 	FlexLite MT
Lighting, motor applications	-55°C to 200°C -67°F to 392°F	<ul style="list-style-type: none"> ■ VW-1 ■ Excellent shop handling ■ No cold-flow problems 	FlexLite HT
Lighting, appliances, motors	-65°C to 250°C -85°F to 482°F	<ul style="list-style-type: none"> ■ Very high temperature ■ VW-1 ■ Superb chemical resistance ■ Excellent shop handling 	FlexLite TX

FlexLite/UL Style Cross-Reference

UL Marking and Labeling

All FlexLite products are UL labeled and reel marked. UL surface marking is additional. Please contact Tyco Electronics for further information.

Primary Wire

Product	UL Style	Temperature Rating	Voltage Rating	AWG Range	Part Description
FlexLite DW	3584	125°C [257°F]	600 volts	4–28	FLDWX031X
FlexLite TW	10208	135°C [275°F]	600 volts	10–32	FLTWX031X
FlexLite MT	10916	150°C [302°F]	600 volts	6–26	FLMTX031X
FlexLite HT	3557	200°C [392°F]	600 volts	6–26	FLHTX031X
FlexLite TX	10297	250°C [482°F]	600 volts	4–28	FLTX031X

Note: Additional UL-recognized cable constructions are available. Please contact Tyco Electronics for details.

Part Numbering System

FL XX X X X X X - Size - X/X - X

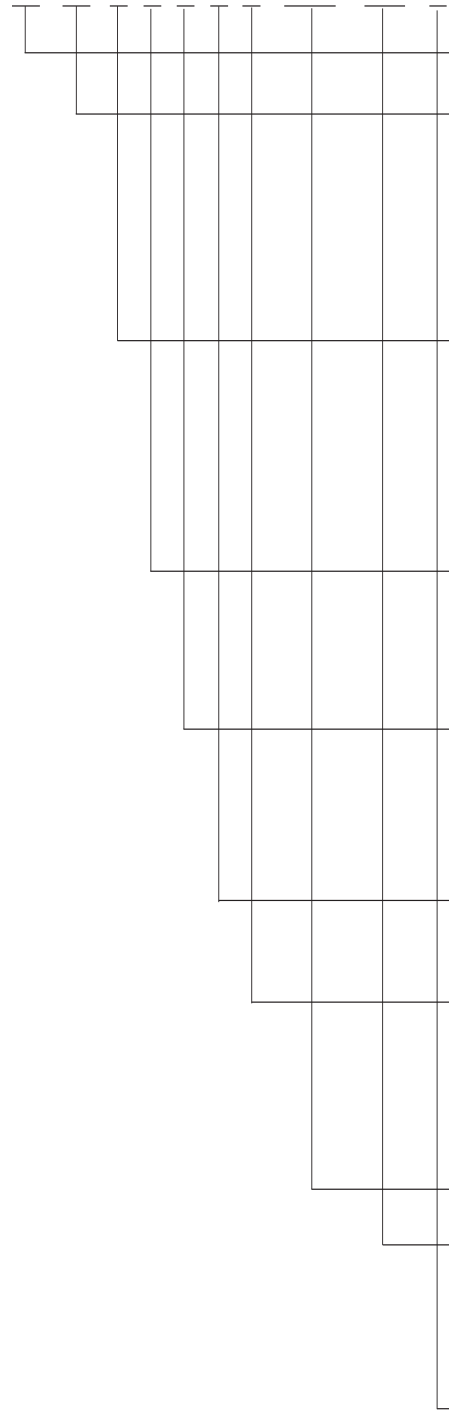

Basic Product Number

Product Type (UL Style - Temperature Rating)

- DW - UL Style 3584 - 125°C
- TW - UL Style 10208 - 135°C
- MT - UL Style 10916 - 150°C
- HT - UL Style 3557 - 200°C
- TX - UL Style 10297 - 250°C

Conductor Stranding

- A - Solid
- B - 7 strand
- C - 19 strand
- D - 37 strand
- E - Rope Lay

Construction

- 0 - Primary wire; or unshielded & unjacketed cable
- 1 - Round braid shielded & jacketed cable*
- 6 - Special constructions

Class of Wire

- 1 - 150 volt
- 2 - 300 volt
- 3 - 600 volt

Number of Conductors

1 through 10 (designator for 10 conductor = 0)

Conductor Type

- 1 - Tin-coated copper
- 2 - Silver-coated copper
- 3 - Nickel coated copper
- 9 - Bare copper

Conductor Size (AWG) or (Metric)

Primary Wire Insulation Color (code per MIL-STD-681)

- 0 - Black 3 - Orange 6 - Blue 9 - White
- 1 - Brown 4 - Yellow 7 - Violet
- 2 - Red 5 - Green 8 - Gray

Jacket Color (code per MIL-STD-681)

(codes same as for Primary Wire Insulation Color)

*Shield coating same as conductor coating

Typical ordering example	19 strand, 20 AWG tin-coated copper, two component, shielded and jacketed cable, 600 volt, blue and white components, white jacket; part number FLDWC1321-20-6/9-9.
Ordering information	For product requiring CUR (Canadian UL) or CSA marking in 14-10 AWG, 19 strand conductors only, the part numbering descriptions above DO NOT apply. Please contact Tyco Electronics for further information.

Dual-Wall Primary Wire

Product Facts

- UL rated operating temperature to 125°C [257°F]
- Non melting insulation material
- Thin-wall product for size and weight savings
- Excellent chemical resistance
- Dual-wall construction for increased mechanical performance
- Compatibility with automated stripping equipment
- Variety of colors and constructions



Applications

FlexLite DW (FLDW) offers a high-performance non melting insulation suitable for a variety of applications, especially those with occasional high-temperature excursions, such as high-power battery-operated devices or intermittent-duty motors or heating elements.

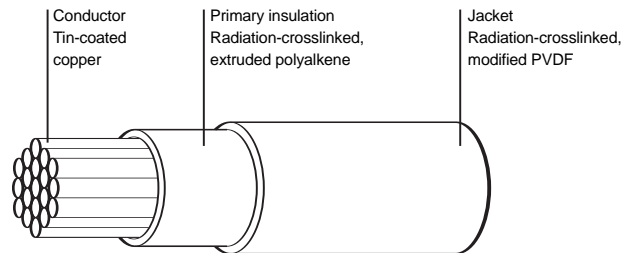

Specifications/Approvals

Series	UL	CUR	CSA	Raychem
DW	Style 3584 Flammability VW-1 Temperature rating 125°C [257°F]	Recognized	Certified AWMIA	WCD-3106

Available in:	Americas	Europe	Asia Pacific
	■	■	■

Construction Details

Part No.	Wire Size (AWG)	Conductor Stranding (No. x AWG)	Nominal Diameter mm [inch]	Finished Wire Maximum Resistance at 20°C (68°F) Ω/km [Ω/1000 ft]	Diameter			Nominal Weight in kg/km [lb/1000 ft]
					Minimum mm [inch]	Nominal mm [inch]	Maximum mm [inch]	
FLDWC0311-26-*	26	19 x 38	.470 [.0185]	132 [40.1]	.965 [.038]	1.02 [.040]	1.07 [.042]	2.38 [1.6]
FLDWC0311-24-*	24	19 x 36	.597 [.0235]	83.3 [25.4]	1.12 [.044]	1.17 [.046]	1.22 [.048]	3.57 [2.4]
FLDWC0311-22-*	22	19 x 34	.749 [.0295]	52.2 [15.9]	1.32 [.052]	1.37 [.054]	1.42 [.056]	5.21 [3.5]
FLDWC0311-20-*	20	19 x 32	.953 [.0375]	32.0 [9.76]	1.52 [.060]	1.57 [.062]	1.63 [.064]	7.59 [5.1]
FLDWC0311-18-*	18	19 x 30	1.18 [.0465]	20.4 [6.22]	1.78 [.070]	1.85 [.073]	1.93 [.076]	11.46 [7.7]
FLDWC0311-16-*	16	19 x 29	1.33 [.0525]	15.8 [4.82]	1.98 [.078]	2.06 [.081]	2.13 [.084]	14.58 [9.8]
FLDWC0311-14-*	14	19 x 27	1.68 [.0660]	10.0 [3.05]	2.39 [.094]	2.49 [.098]	2.59 [.102]	21.88 [14.7]
FLDWD0311-12-*	12	37 x 28	2.16 [.0850]	6.59 [2.01]	2.87 [.113]	2.97 [.117]	3.07 [.121]	32.89 [22.1]

* Replace asterisk with color code designator:
 0 = Black 3 = Orange 7 = Violet
 1 = Brown 4 = Yellow 8 = Gray
 2 = Red 5 = Green 9 = White
 For example: FLDWC0311-20-9 = AWG 20, white.

Construction Details

Nominal CSA Part No.	Wire Size (mm²)	Conductor Stranding (No. x Dia.)	Diameter		Finished Wire Maximum Resistance at 20°C (68°F) Ω/km [Ω/1000 ft]	Diameter			Nominal Weight in kg/km [lb/1000 ft]
			(min.) mm [inch]	(max.) mm [inch]		Lower Spec. Limit mm [inch]	Target Value mm [inch]	Upper Spec. Limit mm [inch]	
FLDWC0311-0.25*	0.25	19 x 0.127	0.55 [.022]	0.63 [.025]	83.6 [25.5]	1.12 [.044]	1.17 [.046]	1.22 [.048]	3.77 [2.53]
FLDWC0311-0.35*	0.35	19 x 0.15	0.72 [.028]	0.77 [.030]	56.1 [17.1]	1.31 [.052]	1.37 [.054]	1.42 [.056]	5.17 [3.46]
FLDWC0311-0.50*	0.50	19 x 0.19	0.86 [.034]	0.88 [.035]	40.1 [12.2]	1.46 [.057]	1.51 [.059]	1.56 [.061]	6.92 [4.64]
FLDWC0311-0.75*	0.75	19 x 0.23	1.05 [.041]	1.08 [.043]	24.7 [7.53]	1.65 [.065]	1.70 [.067]	1.75 [.069]	9.53 [6.39]
FLDWC0311-1.00*	1.00	19 x 0.25	1.17 [.046]	1.26 [.050]	20.0 [6.1]	1.78 [.070]	1.85 [.073]	1.93 [.076]	11.88 [7.96]
FLDWC0311-1.50*	1.50	19 x 0.32	1.46 [.057]	1.51 [.059]	13.7 [4.2]	2.21 [.095]	2.28 [.090]	2.36 [.093]	17.88 [11.98]

* Replace asterisk with color code designator:
 0 = Black 3 = Orange 6 = Blue 9 = White
 1 = Brown 4 = Yellow 7 = Violet
 2 = Red 5 = Green 8 = Gray
 For example: FLDWC0311-20-9 = AWG 20, white.
 FLDWC0311-1.00-9 = Size 1.00 mm², white.

For product requiring CUR (Canadian UL) or CSA marking in 14-10 AWG, 19 strand conductors only, the part numbering descriptions above DO NOT apply. Please contact Tyco Electronics for further information.

Thin-Wall Hookup Wire and Cable

Product Facts

- UL rated operating temperature to 135°C [275°F]
- Thin-wall product for size and weight savings
- Tough insulation material
- Excellent chemical resistance
- Gauge sizes from 10-32 AWG
- No plasticizers or corrosive outgassing, which can be detrimental to sensitive electrical and electronic components



FlexLite TW



Applications

FlexLite TW (FLTW) wire is commonly used in applications that demand smaller, more rugged components, often in elevated temperatures. Designed to offer reduced size while maintaining superior mechanical performance, FLTW in many cases is a lower-cost solution than expensive fluoropolymer wire.

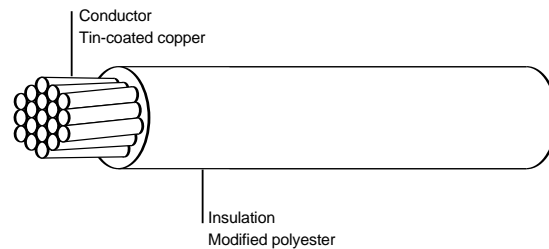

Available in:	Americas	Europe	Asia Pacific
	■	■	■

Specifications/Approvals

FlexLite TW (Continued)

Series	UL	CUR	CSA	Raychem
TW	Style 10208 Temperature rating 135°C [275°F]	Recognized	Certified AWMIA	WCD-3106

Construction Details

Part No.	Wire Size (AWG)	Conductor Stranding (No. x AWG)	Nominal Diameter mm [inch]	Finished Wire Maximum Resistance at 20°C (68°F) Ω/km [Ω /1000 ft]	Diameter			Nominal Weight in kg/km [lb/1000 ft]
					Minimum mm [inch]	Nominal mm [inch]	Maximum mm [inch]	
FLTWC0311-26-*	26	19 x 38	.470 [.0185]	132 [40.1]	.813 [.032]	.864 [.034]	.914 [.036]	1.93 [1.3]
FLTWC0311-24-*	24	19 x 36	.597 [.0235]	83.3 [25.4]	.965 [.038]	1.02 [.040]	1.07 [.042]	2.83 [1.9]
FLTWC0311-22-*	22	19 x 34	.749 [.0295]	52.2 [15.9]	1.14 [.045]	1.19 [.047]	1.24 [.049]	4.17 [2.8]
FLTWC0311-20-*	20	19 x 32	.953 [.0375]	32.0 [9.76]	1.35 [.053]	1.40 [.055]	1.45 [.057]	6.25 [4.2]
FLTWC0311-18-*	18	19 x 30	1.18 [.0465]	20.4 [6.22]	1.60 [.063]	1.65 [.065]	1.70 [.067]	9.52 [6.4]
FLTWC0311-16-*	16	19 x 29	1.33 [.0525]	15.8 [4.82]	1.75 [.069]	1.83 [.072]	1.91 [.075]	12.20 [8.2]
FLTWC0311-14-*	14	19 x 27	1.68 [.0660]	10.0 [3.05]	2.16 [.085]	2.26 [.089]	2.36 [.093]	18.90 [12.7]
FLTWD0311-12-*	12	37 x 28	2.16 [.0850]	6.59 [2.01]	2.64 [.104]	2.74 [.108]	2.84 [.112]	28.87 [19.4]

* Replace asterisk with color code designator:

0 = Black 3 = Orange 6 = Blue 9 = White
 1 = Brown 4 = Yellow 7 = Violet
 2 = Red 5 = Green 8 = Gray

For example: FLTWC0311-22-9 = AWG 22, white.

For product requiring CUR (Canadian UL) or CSA marking in 14-10 AWG, 19 strand conductors only, the part numbering descriptions above DO NOT apply. Please contact Tyco Electronics for further information.

Electronics

FlexLite MT

Medium Temperature Hookup Wire

Product Facts

- UL rated operating temperature to 150°C [302°F]
- Thin-wall, for size and weight savings
- Tough fluoropolymer insulation material
- Excellent stripping and handling
- Variety of constructions and colors
- VW-1 flammability rating
- 600 V rating



Applications

FlexLite MT is a general purpose wire for appliance, electronics, and electrical equipment that require 150°C [302°F] and 600 V ratings.

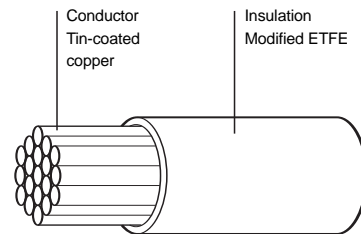

Available in:	Americas	Europe	Asia Pacific
	■	■	■

Electronics

FlexLite MT (Continued)

Specifications/Approvals

Series	UL	CUR	Raychem
MT	Style 10916 Flammability VW-1 Temperature rating 150°C [302°F]	Recognized	WCD-3106

Construction Details

Part No.	Wire Size (AWG)	Conductor Stranding (No. x AWG)	Nominal Diameter mm [inch]	Finished wire Maximum Resistance at 20°C (68°F) Ω/km [Ω /1000 ft]	Diameter			Nominal Weight in kg/km [lb/1000 ft]
					Minimum mm [inch]	Nominal mm [inch]	Maximum mm [inch]	
FLMTC0311-26-*	26	19 x 38	.470 [.0185]	150 [45.8]	.765 [.030]	.800 [.032]	.836 [.034]	1.89 [1.29]
FLMTC0311-24-*	24	19 x 36	.597 [.0235]	94.2 [28.7]	.892 [.035]	.927 [.037]	.963 [.039]	2.75 [1.88]
FLMTC0311-22-*	22	19 x 34	.749 [.0295]	59.4 [18.1]	1.04 [.041]	1.08 [.043]	1.12 [.045]	4.08 [2.75]
FLMTC0311-20-*	20	19 x 32	.953 [.0375]	37.4 [11.4]	1.25 [.049]	1.28 [.051]	1.32 [.053]	6.21 [4.17]
FLMTC0311-18-*	18	19 x 30	1.18 [.0465]	23.5 [7.15]	1.52 [.060]	1.56 [.062]	1.61 [.064]	9.66 [6.49]

* Replace asterisk with color code designator:
 0 = Black 3 = Orange 6 = Blue 9 = White
 1 = Brown 4 = Yellow 7 = Violet
 2 = Red 5 = Green 8 = Gray
 For example: FLMTC0311-18-9 = AWG 18, white.

For product requiring CUR (Canadian UL) or CSA marking in 14-10 AWG, 19 strand conductors only, the part numbering descriptions above DO NOT apply. Please contact Tyco Electronics for further information.

High-Temperature Hookup Wire

Product Facts

- UL rated operating temperature to 200°C [392°F]
- Exceptional chemical resistance
- Thin-wall, for size and weight savings
- Tough fluoropolymer insulation material
- Excellent stripping and handling
- Variety of constructions and colors
- Crosslinked to minimize cold flow
- VW-1 flammability rating
- 600 V rating



FlexLite HT



Applications

FlexLite HT (FLHT) wire is the product of choice for high-temperature applications. It offers shop-handling advantages over silicone/ fiberglass constructions (SF1/SF2) and is cost-competitive with other fluoropolymer wire. Applications include halogen lights and small high-end appliances where space and temperature are issues.

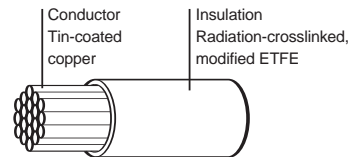

Available in:	Americas	Europe	Asia Pacific
	■	■	■

Electronics

FlexLite HT (Continued)

Specifications/Approvals

Series	UL	CUR	CSA	Raychem
HT	Style 3557 Flammability VW-1 Temperature rating 200°C [392°F]	Recognized	Certified AWMIA/B	WCD-3106

Construction Details

Part No.	Wire Size (AWG)	Conductor Stranding (No. x AWG)	Nominal Diameter mm [inch]	Finished Wire Maximum Resistance at 20°C (68°F) Ω/km [Ω /1000 ft]	Diameter			Nominal Weight in kg/km [lb/1000 ft]
					Minimum mm [inch]	Nominal mm [inch]	Maximum mm [inch]	
FLHTC0311-26-*	26	19 x 38	.470 [.0185]	132 [40.1]	.765 [.0301]	.800 [.0315]	.836 [.0329]	1.89 [1.27]
FLHTC0311-24-*	24	19 x 36	.597 [.0235]	83.3 [25.4]	.892 [.0351]	.927 [.0365]	.963 [.0379]	2.75 [1.85]
FLHTC0311-22-*	22	19 x 34	.749 [.0295]	52.2 [15.9]	1.04 [.0411]	1.08 [.0425]	1.12 [.0439]	4.08 [2.74]
FLHTC0311-20-*	20	19 x 32	.953 [.0375]	32.0 [9.76]	1.25 [.0491]	1.28 [.0505]	1.32 [.0519]	6.21 [4.17]
FLHTC0311-18-*	18	19 x 30	1.18 [.0465]	20.4 [6.22]	1.48 [.0583]	1.52 [.0600]	1.57 [.0617]	9.43 [6.34]
FLHTC0311-16-*	16	19 x 29	1.33 [.0525]	15.8 [4.82]	1.67 [.0656]	1.71 [.0675]	1.76 [.0694]	12.0 [8.09]
FLHTC0311-14-*	14	19 x 27	1.68 [.0660]	10.0 [3.05]	2.03 [.0799]	2.08 [.0820]	2.14 [.0841]	18.6 [12.5]
FLHTD0311-12-*	12	37 x 28	2.16 [.0850]	6.59 [2.01]	2.50 [.0984]	2.57 [.1010]	2.63 [.1036]	28.7 [19.3]

Construction Details

Part No.	Nominal CSA (mm ²)	Conductor Stranding No/Dia. (mm)	Diameter		Finished Wire Maximum Resistance at 20°C (68°F) (ohms/km)	Diameter			Nominal Weight (kg/km)
			(min.) mm [inch]	(max.) mm [inch]		Lower Spec. Limit mm [inch]	Target Value mm [inch]	Upper Spec. Limit mm [inch]	
FLHTC0311-0.25-*	0.25	19/0.127	0.55 [.022]	0.63 [.025]	84.3	0.96 [.038]	1.00 [.039]	1.03 [.041]	2.95
FLHTC0311-0.35-*	0.35	19/0.15	0.74 [.029]	0.76 [.030]	56.1	1.12 [.044]	1.16 [.046]	1.19 [.047]	4.22
FLHTC0311-0.50-*	0.50	19/0.19	0.86 [.034]	0.88 [.035]	40.1	1.24 [.049]	1.27 [.050]	1.31 [.052]	5.59
FLHTC0311-0.75-*	0.75	19/0.23	1.05 [.041]	1.08 [.043]	24.7	1.43 [.056]	1.47 [.058]	1.51 [.059]	7.95
FLHTC0311-1.00-*	1.00	19/0.25	1.17 [.046]	1.26 [.050]	20.0	1.58 [.062]	1.62 [.064]	1.66 [.065]	9.85
FLHTC0311-1.50-*	1.50	19/0.32	1.35 [.053]	1.58 [.062]	13.7	1.82 [.072]	1.87 [.074]	1.92 [.076]	15.69
FLHTC0311-2.00-*	2.00	19/0.36	1.66 [.065]	1.79 [.070]	9.7	2.05 [.081]	2.10 [.083]	2.16 [.085]	18.67
FLHTC0311-2.50-	2.50	19/0.41	1.85 [.073]	2.01 [.080]	8.2	2.24 [.088]	2.31 [.091]	2.38 [.094]	24.62

* Replace asterisk with color code designator:
 0 = Black 3 = Orange 6 = Blue 9 = White
 1 = Brown 4 = Yellow 7 = Violet
 2 = Red 5 = Green 8 = Gray
 For example: FLHTC0311-22-9 = AWG 22, white.
 FLHTC0311-0.50-9 = Size 0.50mm², white.

For product requiring CUR (Canadian UL) or CSA marking in 14-10 AWG, 19 strand conductors only, the part numbering descriptions above DO NOT apply. Please contact Tyco Electronics for further information.

Ultrahigh-Temperature Hookup Wire

Product Facts

- UL rated operating temperature -65°C to 250°C [-85°F to 482°F]
- UL Style 10297
- 600 V rating
- Clear legible wire marking
- Excellent fluid resistance
- Excellent handling characteristics

FlexLite TX

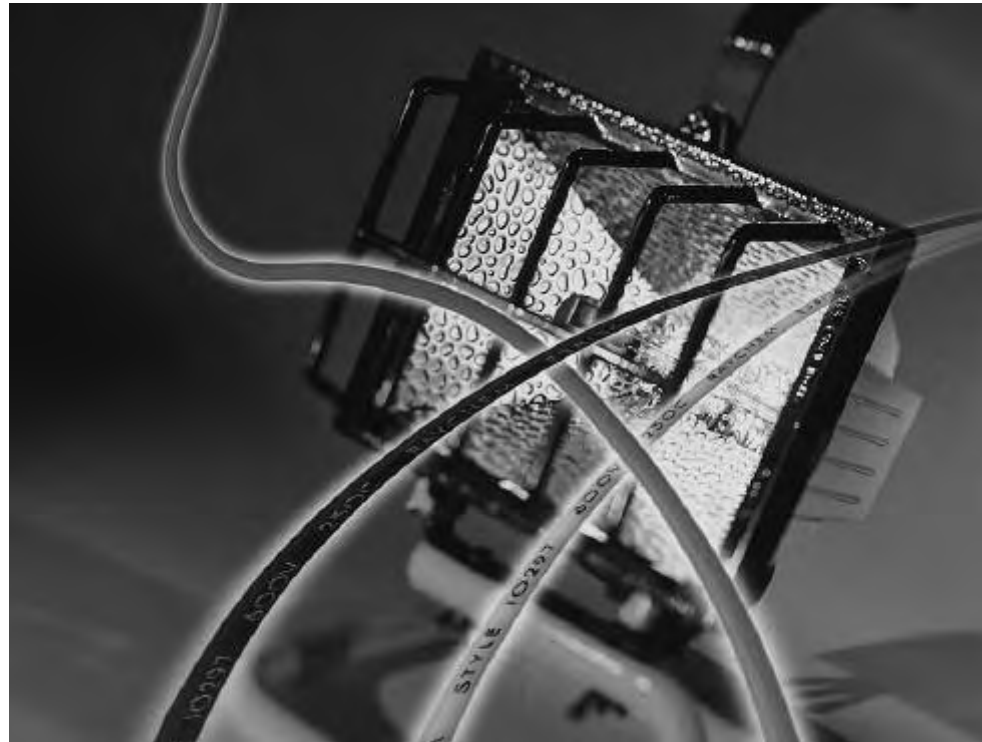

Applications

FlexLite TX wire is a UL recognized hookup wire for lighting fixtures, appliance, wiring and industrial applications requiring a 250°C [482°F] rated wire.

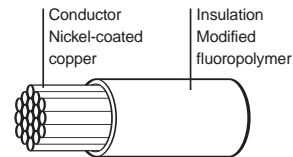

Available in:	Americas	Europe	Asia Pacific
	■	■	■

FlexLite TX (Continued)

Specifications/Approvals

Series	UL	CUR	CSA	Raychem
TX	Style 10297 Flammability VW-1 Temperature Rating 250°C [482°F]	Recognized	AWMIA/B	WCD-3106

Construction Details

Part No.	Wire Size (AWG)	Conductor Stranding (No. x AWG)	Nominal Diameter mm [inch]	Finished Wire Maximum Resistance at 20°C (68°F) Ω/km [Ω /1000 ft]	Diameter			Nominal Weight in kg/km [lb/1000 ft]
					Minimum mm [inch]	Nominal mm [inch]	Maximum mm [inch]	
FLTXB0313-28*	28	7 x 36	.368 [.0145]	224 [68.2]	.940 [.037]	.991 [.039]	1.04 [.041]	2.20 [1.48]
FLTXC0313-26*	26	19 x 38	.470 [.0185]	132 [40.1]	1.04 [.041]	1.09 [.043]	1.14 [.045]	2.96 [1.99]
FLTXC0313-24*	24	19 x 36	.597 [.0235]	83.3 [25.4]	1.17 [.046]	1.22 [.048]	1.27 [.050]	3.97 [2.67]
FLTXC0313-22*	22	19 x 34	.749 [.0295]	52.2 [15.9]	1.30 [.051]	1.37 [.054]	1.45 [.057]	5.46 [3.67]
FLTXC0313-20*	20	19 x 32	.953 [.0375]	32.0 [9.76]	1.50 [.059]	1.57 [.062]	1.65 [.065]	7.84 [5.27]
FLTXC0313-18*	18	19 x 30	1.18 [.0465]	20.4 [6.22]	1.73 [.068]	1.80 [.071]	1.88 [.074]	11.3 [7.60]
FLTXC0313-16*	16	19 x 29	1.33 [.0525]	15.8 [4.82]	1.88 [.074]	1.96 [.077]	2.03 [.080]	13.9 [9.32]
FLTXC0313-14*	14	19 x 27	1.68 [.0660]	10.0 [3.05]	2.18 [.086]	2.29 [.090]	2.39 [.094]	20.5 [13.8]
FLTXD0313-12*	12	37 x 28	2.16 [.0850]	6.59 [2.01]	2.67 [.105]	2.77 [.109]	2.87 [.113]	30.8 [20.7]
FLTXD0313-10*	10	37 x 26	2.72 [.1070]	4.13 [1.26]	3.23 [.127]	3.33 [.131]	3.43 [.135]	48.1 [32.3]

* Replace asterisk with color code designator:
 0 = Black 3 = Orange 6 = Blue 9 = White
 1 = Brown 4 = Yellow 7 = Violet
 2 = Red 5 = Green 8 = Gray
 For example: FLTXC0313-18-9 = AWG 18, white.

For product requiring CUR (Canadian UL) or CSA marking in 14-10 AWG, 19 strand conductors only, the part numbering descriptions above DO NOT apply. Please contact Tyco Electronics logistics for further information.

Flexible, Double Insulated, High Performance Wire for a Wide Range of Industrial Applications

Product Facts

- Highly flame retardant/non melting
- Limited fire hazard
- 600V rated
- Excellent fluid resistance
- Flexible
- Double insulation (for Class 2 equipment)
- Tough, thin wall
- Small size, light weight

FLT



Applications

FLT dual-wall wire combines flexibility with tough thin wall insulation to enable bundles to be routed through areas in which conventional wires cannot be used. Typical applications include control panels, instruments, lighting equipment, electrical appliances, electric motors, electric pumps, robotics, and the automotive industries.

Available in:	Americas	Europe	Asia Pacific
		■	

Approvals

FLT (Continued)

UL Styles 1385
CSA Class 5851
IEC 332-1

Standard Colors

Color Code	Black 0	Brown 1	Red 2	Orange 3	Yellow 4
Color Code	Green 5	Blue 6	Violet 7	Grey 8	White 9

Physical Characteristics

Small Size

FLT equipment wire 600 volt rated has a 0.20 mm nominal wall thickness compared to 0.25mm and 0.38mm for equivalent PTFE and PVC wires in MIL-W-16878, MIL-W-22759 or BS3G210.

For Example: FLT0111 - 0.35 equipment wire 4.38 grams/meter max.

22 AWG PTFE equipment wire MIL-W-22759 5.54 grams/meter max.

strippers. For details of appropriate tools see separate wire handling guide. The tin-plated copper conductor usually specified is easily soldered or crimped.

Light Weight

Due to the thin wall and low density of the insulation materials, considerable weight savings are made over similarly rated PTFE wires.

General Handling

The flexibility of FLT and the ease with which it takes a 'set' makes it one of the easiest of the 'high performance' wires to install. Stripping is done with conventional die blade

Lengths

FLT is available in long continuous lengths and can be supplied for use on automatic cut and strip preparation machines.

Typical Properties

Temperature rated	(Tin-plated conductor) -65°C to +150°C [-85°F to +302°F]
Rated at 125°C [257°F]	In UL style sheet 1385
Voltage rating	600V
No Voltage rating specified	In UL style sheet 1385
Tensile strength + elongation of insulation	30 N/mm ² , 230%
Notch propagation BS 3G230 0.05 mm notch	Pass
Meets BS4066/IEC332-1 Flammability test	Pass
Solder iron resistance (370°C [698°F], 1 minute)	Pass
Shrinkage @ +150°C [+302°F]	< 1%
Low temperature bend	-65°C [-85°F]

Flexible, Double Insulated, High Performance Wire for a Wide Range of Industrial Applications

FLT (Continued)

Environmental Performance

Temperature Rating

FLT wire is rated for continuous operation from -65°C to +125°C [-85°F to +257°F] and for short periods at much higher temperatures.

Mechanical Performance

Radiation crosslinking of the FLT insulation significantly improves the following mechanical characteristics; scrape (sharp edges), cut-through resistance and creep resistance.

Solder Iron/Overload Resistance

Radiation crosslinking ensures that the insulation does not melt at high temperature. As a result FLT wire is resistant to hot solder irons and current overloads which would melt most thermoplastic insulations.

Ordering Information

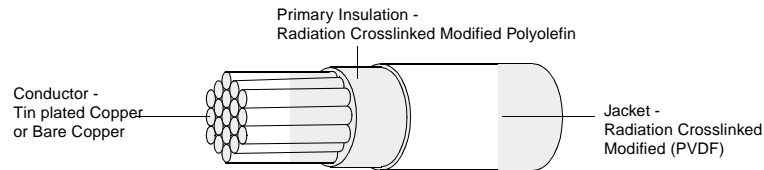

Nominal CSA mm ²	Conductor Stranding No/Dia mm	Conductor Diameter		Finished Wire Maximum Resistance @20°C (68°F) ohms/km	Diameter		Nominal Weight kg/km	Ordering Description
		min. mm [inch]	max. mm [inch]		min. mm [inch]	max. mm [inch]		
0.25	19/0.127	0.55 [.022]	0.63 [.025]	83.6	0.91 [.036]	1.04 [.041]	2.96	FLT011X-0.25-Y
0.35	19/0.15	0.70 [.028]	0.80 [.031]	56.1	1.06 [.042]	1.21 [.048]	4.14	FLT011X-0.35-Y
0.50	19/0.19	0.82 [.032]	0.90 [.035]	40.1	1.18 [.046]	1.31 [.052]	6.63	FLT011X-0.50-Y
0.75	19/0.23	1.05 [.041]	1.15 [.045]	24.7	1.41 [.056]	1.56 [.061]	8.20	FLT011X-0.75-Y
1.00	19/0.25	1.17 [.046]	1.26 [.050]	20.0	1.55 [.061]	1.70 [.067]	10.86	FLT011X-1.00-Y
1.50	19/0.32	1.35 [.053]	1.60 [.063]	13.7	1.73 [.068]	2.06 [.081]	16.47	FLT011X-1.50-Y
2.00	19/0.36	1.66 [.065]	1.85 [.073]	9.9	2.12 [.083]	2.38 [.093]	20.32	FLT011X-2.00-Y
2.50	19/0.41	1.85 [.073]	2.05 [.081]	8.2	2.31 [.091]	2.61 [.103]	26.56	FLT011X-2.50-Y

Note: X = Conductor Type 1 = Tin Plated Copper 9 = Bare Copper
Y = Color (see color code on page 9-58)

Product Facts

- 19-strand conductor for flexibility



Thermocouple Extension Cable

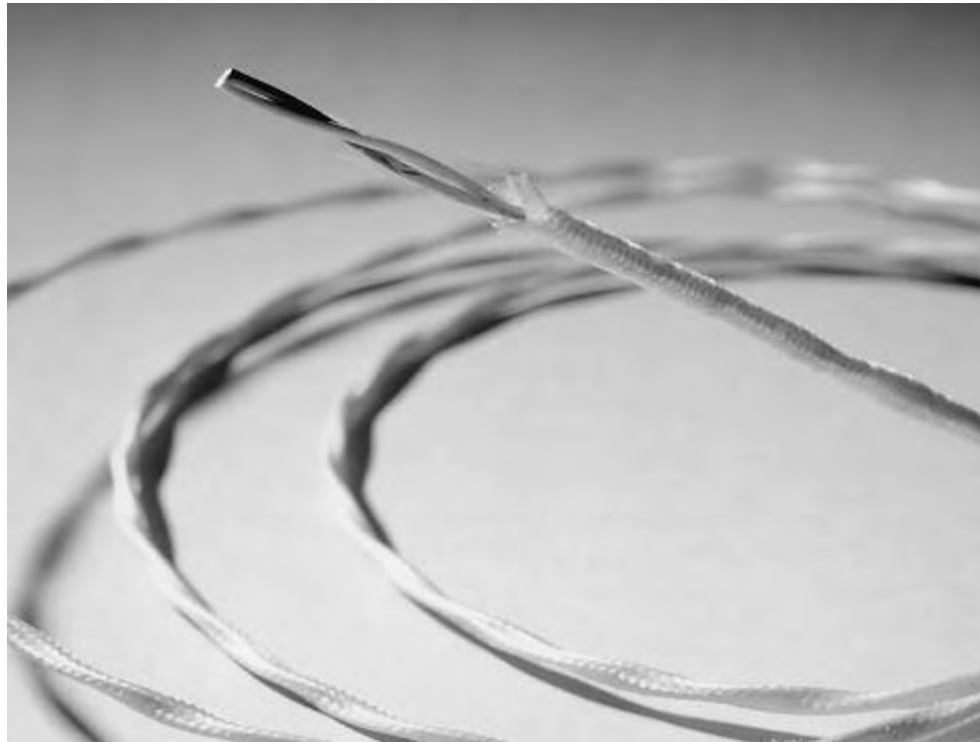

Applications

Tyco Electronics manufactures a broad range of Raychem Thermocouple extension cables in four thermoelement combinations. Each provides accurate transmission of electromotive force (EMF) from a Thermocouple element lead wire of the same conductor material to a thermometer, also known as a pyrometer.

All four types of Thermocouple extension cables use 19-strand conductors and are available in twisted pair, jacketed twisted pair, and shielded

and jacketed twisted pair configurations. A range of cables is available from 16 AWG to 24 AWG.

Wires and cables are insulated and jacketed with radiation-crosslinked ETFE, which has a continuous operating temperature of -65°C to +200°C [-85°F to +392°F]. This material, which is fully specified in Raychem SPEC 55, has excellent physical properties and is highly resistant to a wide range of chemicals.

Operating Temperature Range

-65°C to 200°C
[-85°F to 392°F]

Available in:	Americas	Europe	Asia Pacific
	■	■	■

Properties

Extension Cable Type	Thermoelement Combination	Initial Calibration Tolerances for Thermocouple Extension Wires		
		Temperature Range	Limit of Range	EMF (mv)* (min.-max.)
EX	Chromel-Constantan	0°C to 200°C [0°F to 392°F]	±1.7°C [35.1°F]	6.18–6.45
JX	Iron-Constantan	0°C to 200°C [0°F to 392°F]	±2.2°C [36.0°F]	5.15–5.39
KX	Chromel-Alumel	0°C to 200°C [0°F to 392°F]	±2.2°C [36.0°F]	4.00–4.19
TX	Copper-Constantan	0°C to 100°C [0°F to 212°F]	±1.0°C [32.0°F]	4.24–4.32

Note: The above is in accordance with ANSI-MC-96.1-1982.
 *EMF is measured in millivolts (mv) at 100°C [212°F] with reference junction at 0°C [0°F].

Product Dimensions** (Nominal)

AWG Size	Twisted Pair		Twisted, Jacketed Pair		Twisted, Shielded, 38 AWG Braid Strand, Jacketed Pair	
	Outside Diameter	Weight in kg/km (lb/1000 ft)	Outside Diameter	Weight in kg/km (lb/1000 ft)	Outside Diameter	Weight in kg/km (lb/1000 ft)
24	2.29 [.090]	7.3 [4.9]	2.67 [.106]	9.9 [6.7]	3.12 [.123]	16.5 [11.1]
22	2.60 [.102]	9.9 [6.7]	2.99 [.118]	13.0 [8.8]	3.43 [.135]	21.4 [14.4]
20	2.99 [.118]	14.4 [9.7]	3.40 [.134]	18.0 [12.1]	3.83 [.151]	27.8 [18.7]
18	3.56 [.140]	20.9 [14.1]	3.96 [.156]	25.1 [16.9]	4.34 [.173]	37.5 [25.2]
16	3.96 [.156]	26.3 [17.7]	4.37 [.172]	30.9 [20.8]	4.80 [.189]	44.9 [30.2]

**Dimensions for 19-strand-conductor thermocouple. Extension Types EX, JX, KX, and TX.

Extension Cable

Color-Coding

Thermocouple extension cables are available with the wires color-coded in accordance with four standards: MIL-STD-687, ANSI-MC-96.1, British Standard Code BS 1843, and Japanese JIS-C-1602.

Special Cables

Thermocouple extension cables are also available in solid-conductor and seven-strand-conductor configurations. They come in a variety of thermoelement combinations, gauges,

insulations, and multiple-pair designs, and they are available for outer space applications. Contact Tyco Electronics for details.

Extension Cable

Type	Chromel +	Constantan -	Jacket (if present)	Color code Wire	Jacket
ANSI-MC-96.1	Violet	Red	Violet	7/2	7
British Std.-BS 1843	Brown	Blue	Brown	1/6	1
JIS-C-1602	Violet	Red	Violet	7/2	7
Type JX	Iron +	Constantan -	Jacket	Wire	Jacket
MIL-STD-687	Black	Yellow	White	0/4	9
ANSI-MC-96.1	White	Red	Black	9/2	0
British Std.-BS 1843	Yellow	Blue	Black	4/6	0
JIS-C-1602	Red	White	Yellow	2/9	4
Type KX	Chromel +	Alumel -	Jacket	Wire	Jacket
MIL-STD-687	White	Green	White	9/5	9
ANSI-MC-96.1	Yellow	Red	Yellow	4/2	4
British Std.-BS 1843	Brown	Blue	Red	1/6	2
JIS-C-1602	Red	White	Blue	2/9	6
Type TX	Copper +	Constantan -	Jacket	Wire	Jacket
MIL-STD-687	Red	Yellow	White	2/4	9
ANSI-MC-96.1	Blue	Red	Blue	6/2	6
British Std.-BS 1843	White	Blue	Blue	9/6	6
JIS-C-1602	Red	White	Brown	2/9	1

Part Number Selection Table

Thermocouple Extension Cable (Continued)

The Thermocouple cable options outlined in the table on the previous page can be ordered from the table below.

Tyco Electronics will assign a new part number on request for cables falling outside the range shown in the table.

Type	Twisted Pair	Twisted, Jacketed Pair	Shield Plating*	Twisted, Shielded, Jacketed Pair
EX	CTC-0077	CTC-0079	T	CTC-0074
			N	55A6169
JX	55A8131	CTC-0080	T	CTC-0044
			T	CTC-0018
KX	55A8002	CTC-0012	N	CTC-0015
			S	CTC-0057
			T	CTC-0073
TX	CTC-0078	CTC-0081	T	CTC-0073

*T = Tin-coated copper.
 N = Nickel-coated copper.
 S = Silver-coated copper.

Lightweight, Ruggedized Filterline Wire and Cable

Product Facts

- Suppresses EMI above 100 MHz
- Light weight, small size
- SPEC 55 insulation
- 600 volt
- -65°C to 150°C †
[-85°F to 302°F]

† -65°C to 200°C [-85°F to 392°F] also available



Available in:

- Americas ■
- Europe ■
- Asia Pacific ■

ElectroLoss Filterline



Applications

Today's performance needs for military and commercial electronic systems require increasingly sophisticated equipment and greater use of composite structures and enclosures. As electronics become more sensitive, the EMI protection level for electrical equipment is increasing. The Raychem ElectroLoss FilterLine wire and cable provide a high degree of EMI protection while functioning as conventional electrical wiring.

ElectroLoss FilterLine products include high-performance wire and cable, which when used as specified, suppress conducted and radiated EMI above 100 MHz.

A reliable alternative to conventional discrete filters and filter-pin connectors, ElectroLoss FilterLine cables are flexible, lightweight, and compatible with high-density connectors.

The Raychem ElectroLoss FilterLine wire and cable meets the performance requirements of MIL-C-85485, a military specification developed to provide EMI protection for military electrical interconnects.

The absorptive layer in ElectroLoss FilterLine cable is constructed of a ferrite-loaded high-temperature polymer, which provides high-frequency EMI absorptive characteristics. Achieving maximum attenuation requires concentrating the electromagnetic fields

in the absorptive layer — either with a metallic shield on each wire or by an overall metallic shield protecting a bundle of individual component wires.

Radiation-crosslinked, modified conductive EFTE jackets are used over shielded filter line cables to eliminate pathways between adjacent cable shields.

Application-driven alternative ElectroLoss FilterLine constructions built to the same rigorous standards demanded of the MIL SPEC products are also available. These alternatives offer significant weight savings through the use of flat braids, improved laser mark contrast, and a broader choice of conductors.

55FA0511

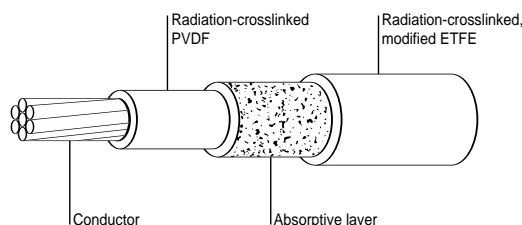

55FB1511

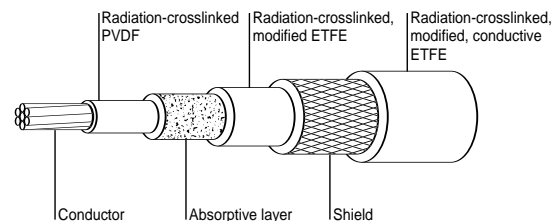

† -65°C to 200°C [-85°F to 392°F] also available.

ElectroLoss Filterline (Continued)

Performance

Effective against conducted EMI ElectroLoss FilterLine wire and cable systems attenuate high-frequency signals to pass with minimum loss. When properly installed and used, filter line wire and cables function as low-pass electrical filters, attenuating both

conducted and radiated EMI above 100MHz. The performance of ElectroLoss FilterLine product is best demonstrated by measuring the attenuation (insertion loss) of a length of cable over a broad range of frequencies. Graph 1 depicts typical insertion loss characteristics.

Graph 1 - Typical insertion loss

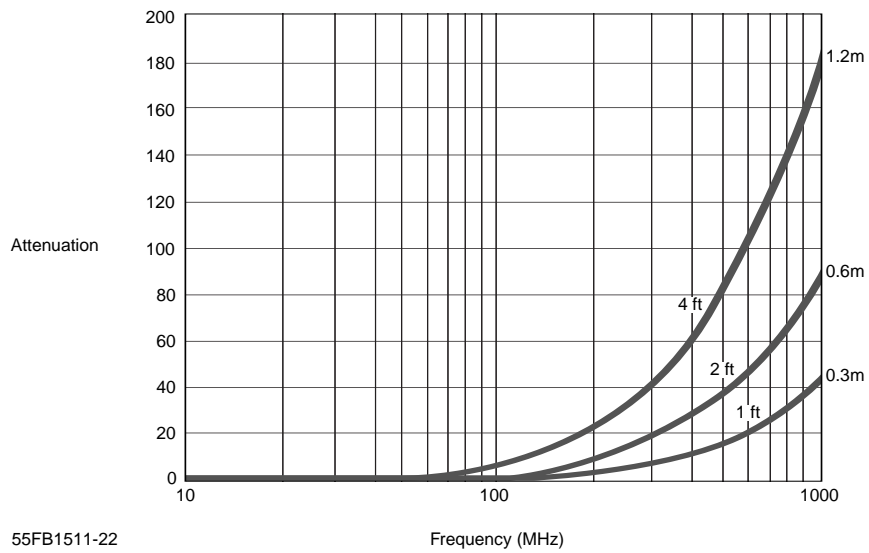

55FB1511-22

Temperature rating	-65°C to +150°C † [-85°F to 302°F]
Voltage rating	600V r.m.s

† -65°C to 200°C [-85°F to 392°F] also available

Lightweight, Ruggedized
Filterline Wire and Cable

Single Conductor Wire
Specifications

AWG Size	Conductor Stranding (Number x AWG)	Maximum Outside Diameter mm (in)	Maximum Weight Kg/Km (lb/1000 ft)	MIL-SPEC Part Number	Raychem Part Number
24	19 x 36 silver coated high strength copper alloy	1.19 [.047]	4.46 [3.0]	M85485/10-24A	55FA0514-24-*
22	19 x 34 tin coated copper	1.37 [.054]	5.95 [4.0]	M85485/9-22A	55FA0511-22-*
20	19 x 32 tin coated copper	1.57 [.062]	8.63 [5.8]	M85485/9-20A	55FA0511-20-*
18	19 x 30 tin coated copper	1.85 [.073]	12.95 [8.7]	M85485/9-18A	55FA0511-18-*
16	19 x 29 tin coated copper	2.08 [.082]	16.67 [11.2]	M85485/9-16A	55FA0511-16-*
14	19 x 27 tin coated copper	2.51 [.099]	23.96 [16.1]	M85485/9-14A	55FA0511-14-*
12	37 x 28 tin coated copper	2.95 [.116]	35.71 [24.0]	M85485/9-12A	55FA0511-12-*
10	37 x 26 tin coated copper	3.58 [.141]	55.06 [37.0]	M85485/9-10A	55FA0511-10-*

* The color of component wire shall be light violet designated by 7L. The designated colors for components in finished cable shall be light violet for component 1 and light violet with stripe designators for remaining component wires as follows:

Component wire	1	2	3	4	5
Color designator	7L	7L6	7L3	7L5	7L2

Unshielded, Unjacketed 2-5
Conductor Cable
Specifications

AWG Size	Number of Conductor	Maximum Outside Diameter	Maximum Weight Kg/Km (lb/1000 ft)	MIL-SPEC Part Number	Raychem Part Number.
24	2	2.39 [.094]	9.08 [6.1]	M85485/11-24M2A	55FA0524-24.*
22	2	2.74 [.108]	12.20 [8.2]	M85485/11-22T2A	55FA0521-22.*
20	2	3.15 [.124]	17.56 [11.8]	M85485/11-20T2A	55FA0521-20.*
18	2	3.71 [.146]	26.34 [17.7]	M85485/11-18T2A	55FA0521-18.*
16	2	4.17 [.164]	33.93 [22.8]	M85485/11-16T2A	55FA0521-16.*
14	2	5.03 [.198]	48.81 [32.8]	M85485/11-14T2A	55FA0521-14.*
24	3	2.59 [.102]	13.69 [9.2]	M85485/11-24M3A	55FA0534-24.*
22	3	2.97 [.117]	18.15 [12.2]	M85485/11-22T3A	55FA0531-22.*
20	3	3.40 [.134]	26.34 [17.7]	M85485/11-20T3A	55FA0531-20.*
18	3	4.01 [.158]	39.58 [26.6]	M85485/11-18T3A	55FA0531-18.*
16	3	4.50 [.177]	51.03 [34.3]	M85485/11-16T3A	55FA0531-16.*
14	3	5.44 [.214]	73.36 [49.3]	M85485/11-14T3A	55FA0531-14.*
24	4	3.28 [.129]	18.15 [12.2]	M85485/11-24M4A	55FA0544-24.*
22	4	3.78 [.149]	24.25 [16.3]	M85485/11-22T4A	55FA0541-22.*
20	4	4.34 [.171]	35.27 [23.7]	M85485/11-20T4A	55FA0541-20.*
18	4	5.11 [.201]	52.82 [35.5]	M85485/11-18T4A	55FA0541-18.*
16	4	5.74 [.226]	68.00 [45.7]	M85485/11-16T4A	55FA0541-16.*
14	4	6.91 [.272]	97.76 [65.7]	M85485/11-14T4A	55FA0541-14.*
24	5	3.58 [.141]	22.77 [15.3]	M85485/11-24M5A	55FA0554-24.*
22	5	4.11 [.162]	30.36 [20.4]	M85485/11-22T5A	55FA0551-22.*
20	5	4.72 [.186]	44.04 [29.6]	M85485/11-20T5A	55FA0551-20.*
18	5	5.56 [.219]	66.07 [44.4]	M85485/11-18T5A	55FA0551-18.*
16	5	6.25 [.246]	84.96 [57.1]	M85485/11-16T5A	55FA0551-16.*
14	5	7.54 [.297]	122.16 [82.1]	M85485/11-14T5A	55FA0551-14.*

* The color of component wire shall be light violet designated by 7L.
The designated colors for components in finished cable shall be light violet for component 1 and light violet with stripe designators for remaining component wires as follows:

Component wire	1	2	3	4	5
Color designator	7L	7L6	7L3	7L5	7L2

Lightweight, Ruggedized
Filterline Wire and Cable

Shielded, Jacketed 1-5
Conductor Cable
Specifications

Electroloss Filterline Wire and
Cable Light Weight
Ruggedized Constructions

AWG Size	Number of Conductors	Shield Size AWG Tin Coated Copper	Maximum Outside Diameter mm (in)	Maximum Weight Kg/Km (lb/1000 ft)	MIL-SPEC Part Number	Raychem Part Number
24	1	38	2.13 [.084]	10.86 [7.3]	M85485/12-24U1A	55FB1514-24-*
22	1	38	2.31 [.091]	13.09 [8.8]	M85485/12-22T1A	55FB1511-22-*
20	1	38	2.51 [.099]	16.67 [11.2]	M85485/12-20T1A	55FB1511-20-*
18	1	38	2.79 [.110]	22.17 [14.9]	M85485/12-18T1A	55FB1511-18-*
16	1	38	3.02 [.119]	26.78 [18.0]	M85485/12-16T1A	55FB1511-16-*
14	1	38	3.45 [.136]	35.86 [24.1]	M85485/12-14T1A	55FB1511-14-*
12	1	38	3.89 [.153]	49.40 [33.2]	M85485/12-12T1A	55FB1511-12-*
10	1	38	4.55 [.179]	71.57 [48.1]	M85485/12-10T1A	55FB1511-10-*
24	2	38	3.33 [.131]	19.34 [13.0]	M85485/12-24U2A	55FB1524-24-*
22	2	38	3.68 [.145]	23.81 [16.0]	M85485/12-22T2A	55FB1521-22-*
20	2	38	4.09 [.161]	30.50 [20.5]	M85485/12-20T2A	55FB1521-20-*
18	2	38	4.65 [.183]	41.37 [27.8]	M85485/12-18T2A	55FB1521-18-*
16	2	38	5.11 [.201]	50.59 [34.0]	M85485/12-16T2A	55FB1521-16-*
14	2	38	6.02 [.237]	69.49 [46.7]	M85485/12-14T2A	55FB1521-14-*
24	3	38	3.53 [.139]	25.30 [17.0]	M85485/12-24U3A	55FB1534-24-*
22	3	38	3.91 [.154]	31.10 [20.9]	M85485/12-22T3A	55FB1531-22-*
20	3	38	4.34 [.171]	41.07 [27.6]	M85485/12-20T3A	55FB1531-20-*
18	3	38	4.95 [.195]	56.54 [38.0]	M85485/12-18T3A	55FB1531-18-*
16	3	38	5.44 [.214]	69.94 [47.0]	M85485/12-16T3A	55FB1531-16-*
14	3	38	6.43 [.253]	96.87 [65.1]	M85485/12-14T3A	55FB1531-14-*
24	4	38	4.19 [.165]	31.69 [21.3]	M85485/12-24U4A	55FB1544-24-*
22	4	38	4.67 [.184]	39.58 [26.6]	M85485/12-22T4A	55FB1541-22-*
20	4	38	5.23 [.206]	52.68 [35.4]	M85485/12-20T4A	55FB1541-20-*
18	4	38	5.99 [.236]	72.91 [49.0]	M85485/12-18T4A	55FB1541-18-*
16	4	38	6.68 [.263]	91.36 [61.4]	M85485/12-16T4A	55FB1541-16-*
14	4	38	7.85 [.309]	125.59 [84.4]	M85485/12-14T4A	55FB1541-14-*
24	5	38	4.52 [.178]	37.80 [25.4]	M85485/12-24U5A	55FB1554-24-*
22	5	38	5.05 [.199]	47.32 [31.8]	M85485/12-22T5A	55FB1551-22-*
20	5	38	5.66 [.223]	63.39 [42.6]	M85485/12-20T5A	55FB1551-20-*
18	5	38	6.55 [.258]	89.43 [60.1]	M85485/12-18T5A	55FB1551-18-*
16	5	38	7.24 [.285]	111.00 [74.6]	M85485/12-16T5A	55FB1551-16-*
14	5	38	8.53 [.336]	153.26 [103.0]	M85485/12-14T5A	55FB1551-14-*

* The color of component wire shall be light violet designated by 7L. The designated colors for components in finished cable shall be light violet for component 1 and light violet with stripe designators for remaining component wires as follows:

Component wire	1	2	3	4	5
Color designator	7L	7L6	7L3	7L5	7L2

Fluid Resistance

Fluids	Hydrocarbons
	Fuels and lubricants
Alcohols	Cleaning fluids
	Glycols
Synthetic fuels and lubricants	Ketones

Small, Lightweight Coaxial Cables

Product Facts

- Light weight, small size
- Temperature range of
-65°C to 200°C
[-85°F to 392°F]
- Low capacitance and attenuation
- High velocity of propagation
- High flexibility

Cheminax Coaxial Cables



Applications

Cheminax controlled electrical cables are used in the aircraft and aerospace industries. They have a wide range of applications in missiles, avionics, radio-frequency and microwave systems, computers, security and surveillance systems, and communications. Cheminax coaxial cables were designed to solve interconnect problems in

electronic systems, such as computers, military equipment, and other areas of high-density packing, where cables are required to perform to more exacting specifications than standard radio-grade (RG) or UL recognized (UR) constructions. Tyco Electronics' advanced materials technology has allowed the design and development of Raychem

Cheminax miniature coaxial cables that offer substantial savings in size and weight while improving mechanical performance and reducing attenuation. Cables can be designed that are either smaller and lighter than standard RG and UR cables or provide significantly lower attenuation and capacitance with no significant increase in size.

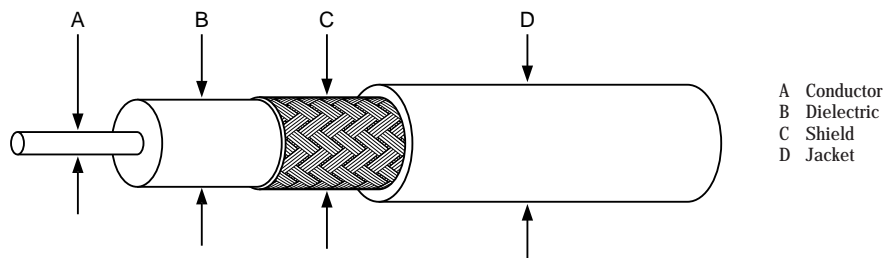

- A Conductor
- B Dielectric
- C Shield
- D Jacket

Available in:	Americas	Europe	Asia Pacific
	■	■	■

Part Numbering System

95 27 A 1 3 1 7 - 0 Example: 9527A1317-0
 XX XX X X X X X X - X

Jacket Color Identification Code

- | | | |
|------------|------------|------------------------|
| 0 - Black | 4 - Yellow | 8 - Gray |
| 1 - Brown | 5 - Green | 9 - White |
| 2 - Red | 6 - Blue | 9X - Translucent White |
| 3 - Orange | 7 - Violet | X - Clear |

Conductor Type

- 1 - Tin-coated copper
- 2 - Silver-coated copper
- 3 - Nickel-coated copper
- 4 - Silver-coated high strength copper alloy
- 5 - Aluminum
- 6 - Nickel-coated high strength copper alloy
- 7 - Tin-coated copper-clad steel
- 8 - Silver-coated copper-clad steel
- 9 - Bare copper
- 0 - Other
- A - Silver-coated CS95

Dielectric Material

- | | |
|------------------------------|--------------------------------|
| 1 - Rayfoam L (Polyethylene) | 6 - Modified XL-ETFE (SPEC 55) |
| 2 - Rayfoam H (Foamed FEP) | 7 - Flex XL-ETFE |
| 3 - Rayolin F (Solid) | 8 - Rayfoam M (Foamed MFA) |
| 4 - Modified FEP (Solid) | 0 - Other |

Outer Jacket Material

- | | |
|--------------------------------------|-----------------------------------|
| 1 - General purpose PVF ² | 6 - Modified XL-ETFE (SPEC 55) |
| 2 - Outerspace PVF ² | 7 - Flex XL-ETFE (SPEC 80) |
| 3 - Thermorad F & S | 8 - Zerohal & Thermorad Low Smoke |
| 4 - Modified FEP | 9 - None |
| 5 - ETFE (Uncrosslinked) | 0 - Other |

Construction

- | | |
|------------------------|----------------------|
| 1 - Round braid | 6 - Triax - other |
| 2 - Flat braid | 7 - Other |
| 3 - 2 round braids | 8 - Composite shield |
| 4 - 2 shields (other) | 9 - Core only |
| 5 - Triax-round braids | 0 - Other |

Variation

- | | |
|---------------------------------|------------------------------|
| A - Standard | U - Low Loss |
| B - Low Noise | W - Waterblocked |
| C-Z - Sequential within any PNs | S - Outer Space Requirements |

Conductor Size (AWG)

Always 2 digits - 0X if under 10 AWG

Impedance

Always 2 digits - last 2 digits if over 100 ohms
 0X (1 digit) if under 10 ohms

Cheminax Coaxial Cables (Continued)

Specifications/Approvals

Series	Raychem
Cheminax cables	1200

Product Dimensions (Nominal)

Typical Product Part No.	Impedance (ohms)	Capacitance pF/m (pF/ft)	Attenuation at 400 MHz dB/100m (dB/100 ft)	A	B	C	D	Weight in kg/km (lb/1000ft)
				Conductor Diameter	Dielectric Diameter	Shield Diameter	Jacket Diameter	
5012E1339	50	98.4 [30.0]	14.8 [4.5]	2.26 [.089]	7.24 [.285]	7.98 [.314]	10.24 [.403]	162.2 [109.0]
5012M1612	50	82.0 [25.0]	16.1 [4.9]	2.26 [.089]	6.07 [.239]	6.60 [.260]	7.06 [.278]	74.5 [50.1]
5024A1311	50	83.7 [25.5]	50.3 [15.3]	0.62 [.025]	1.70 [.067]	2.18 [.085]	2.67 [.104]	11.8 [7.9]
5026D1027	50	88.9 [27.1]	63.7 [19.4]	0.48 [.019]	1.27 [.050]	1.70 [.067]	2.21 [.087]	11.8 [7.9]
5030A1317	50	90.2 [27.5]	97.5 [29.7]	0.30 [.012]	0.79 [.031]	1.12 [.044]	1.57 [.062]	4.5 [3.0]
5030A1424	50	100.4 [30.6]	94.5 [28.8]	0.30 [.012]	0.86 [.034]	1.19 [.047]	1.60 [.063]	5.7 [3.8]
7520A1311	75	56.1 [17.1]	20.0 [6.1]	1.02 [.040]	4.57 [.180]	5.11 [.201]	6.12 [.241]	43.2 [29.0]
7524A1311	75	56.4 [17.2]	31.8 [9.7]	0.62 [.025]	2.82 [.111]	3.25 [.128]	3.86 [.152]	19.2 [12.9]
7528H1424	75	54.5 [16.6]	44.0 [13.4]	0.32 [.013]	1.37 [.054]	1.73 [.068]	2.13 [.084]	8.9 [6.0]
7530A1317	75	60.4 [18.3]	58.8 [17.9]	0.30 [.012]	1.35 [.053]	1.78 [.07]	2.29 [.09]	8.3 [5.6]
7530H1424	75	57.4 [17.5]	58.1 [17.7]	0.30 [.012]	1.30 [.051]	1.73 [.068]	2.03 [.08]	8.5 [5.7]
9522A1311	95	44.3 [13.5]	19.7 [6.0]	0.79 [.031]	5.51 [.217]	6.05 [.238]	7.32 [.288]	55.1 [37.0]
9527J1528	95	44.3 [13.5]	31.8 [9.7]	0.43 [.017]	2.84 [.112]	3.18 [.125]	3.58 [.141]	19.2 [12.9]
9530H1014	95	44.3 [13.5]	44.3 [13.5]	0.30 [.012]	1.83 [.072]	2.26 [.089]	2.62 [.103]	13.1 [8.8]

Note: All values are nominal.

Product Characteristics

General	Conductor Range Operating Temperature Range*	12 AWG to 30 AWG -65°C to 200°C [-85°F to 392°F]
Electrical	Impedance range Dielectric constant Velocity of propagation	50 ohms to 125 ohms 1.65–2.3 67%–80%

*Temperature rating varies depending on materials used in specific construction.

Small, Lightweight Coaxial Cables

Properties (per SCD)

Physical	Typical Value of Dielectric Material					
	Rayfoam L	Rayfoam H	Rayolin F			
Tensile (min.)	6.8 MPa (1000 psi)	4.1 MPa (600 psi)	12.2 MPa (1800 psi)			
Elongation (min.)	50%	50%	200%			
Electrical						
Dielectric withstand (min.)	1000 V	1000 V	1000 V			
Velocity of propagation (nom.)	78%	78%	67%			
Dielectric constant	1.65	1.65	2.2			
Physical	Type Value of Jacket Material					
	Thermorad	SPEC 55	FlexLine	FEP	Zerohal	SPEC 44
Tensile (min.)	13.6 MPa (2000 psi)	34 MPa (5000 psi)	20.4 MPa (3000 psi)	13.6 MPa (2000 psi)	8.2 MPa (1200 psi)	27.2 MPa (2500 psi)
Elongation (min.)	250%	50%	100%	200%	150%	150%
Temperature (max.)	125°C [257°F]	200°C [392°F]	200°C [392°F]	200°C [392°F]	125°C [257°F]	150°C [302°F]
Flammability*	Method C	Method B	Method B	Method B	Method B	Method B
Fluid category*	C	A	A	A	C	

*See Raychem specification WCD-1200 for details.

Raychem Alternatives to RG Cables

RG/U	Raychem Alternative	Comments
4	5020A3311-0	Small/light
	5018D3311-0	Improved electricals
5	5018D3311-0	Small/light
8	5012E1339-0	Dimensionally similar
11	7518A1311-0	Small/light
29	5020A1311-0	Small/light
31	5012E1339-0	Dimensionally similar
55	5020A3311-0	Small/light
	5018D3311-0	Improved electricals
58	5021D1331-0	Dimensionally similar
	5020A1311-0	Small/light
	5018A1311-0	Improved electricals
59	7523D1331-0	Dimensionally similar
	7524A1311-0	Small/light
62	7520A1311-0	Improved electricals
	9524A1311-0	Small/light
63	2524A1311-0	Small/light
87	5012A3311-0	Small/light
89	5012A3311-0	Small/light
115	5012A3311-0	Small/light
122	5020A1311-0	Improved electricals
124	7524A1311-0	Small/light
133	9524A1311-0	Small/light
140	7524A1311-0	Small/light
141	5020A1311-0	Small/light
142	5019D3318-0	Small/light
	5018D3311-0	Improved electricals
144	7518A1311-0	Small/light
149	7518A1311-0	Small/light

RG/U	Raychem Alternative	Comments
159	5020A1311-0	Small/light
174	5026A1311-0	Small/light
	5024A1311-0	Improved electricals
178	5030A1317-0	Small/light
	5028A1317-0	Improved electricals
179	7530A1317-0	Small/light
	7528A1317-0	Improved electricals
180	9530E1014-0	Small/light
	9527A1318-9	Improved electricals
188	5026A1311-0	Small/light
	5024A1311-0	Improved electricals
210	9524A1311-0	Small/light
213	5012E1339-0	Dimensionally similar
214	5012A3311-0	Small/light
223	5019D3318-0	Small/light
	5018D3311-0	Improved electricals
225	5012A3311-0	Small/light
235	5012A3311-0	Small/light
279	7524A1311-0	Dimensionally similar
282	5024A1311-0	Small/light
302	7524A1311-0	Small/light
303	5020A1311-0	Small/light
304	5018A1311-0	Small/light
316	5026A1311-0	Small/light
	5024A1311-0	Improved electricals
393	5012A3311-0	Small/light
400	5020A3311-0	Small/light
	5018D3311-0	Improved electricals
403	5030A5314-0	Small/light

Note: To complement the mechanical and electrical features of Cheminax miniature coax cable, Tyco Electronics offers Raychem SolderSleeve, SolderTacts, and PinPak termination devices and RF connector devices. Controlled electrical cables and components are available for data bus systems.

Cheminax — High Performance Alternatives to Standard Cables (Continued)

Raychem Alternatives to UR Cables

UR	Raychem Alternative	Comments
43	5020A1311-0	Small/light
57	7518A1311-0	Small/light
65	7518A1311-0	Small/light
67	5012E1339-0	Dimensionally similar
70	7524A1311-0	Small/light
72	5020A1311-0	Small/light
76	5020A1311-0	Small/light
84	7524A1311-0	Small/light
90	7522A1311-0	Small/light
95	5026A1311-0	Small/light
96	9524A1311-0	Dimensionally similar
102	5012E1339-0	Dimensionally similar
104	7522A1311-0	Small/light
105	7518A1311-0	Small/light
106	7222A1311-0	Small/light
107	5012E1339-0	Small/light
108	5020A1311-0	Small/light
109	5026A1311-0	Small/light
110	5030A1317-0	Small/light
111	7530A1317-0	Small/light
112	5012A3311-0	Small/light
113	7518A1311-0	Small/light
116	5026A1311-0	Small/light
117	7524A1311-0	Small/light
200	7524A1311-0	Dimensionally similar
201	7522A1311-0	Dimensionally similar
202	7522A1311-0	Dimensionally similar
203	7520A1311-0	Small/light
204	7518A1311-0	Dimensionally similar
205	7518A1311-0	Dimensionally similar
207	7524A1311-0	Small/light
208	7524A1311-0	Small/light
210	7524A1311-0	Small/light
301	5020A1311-0	Small/light
306	7524A1311-0	Small/light

Note: To complement the mechanical and electrical features of Cheminax miniature coax cable, Tyco Electronics offers Raychem SolderSleeve, SolderTacts, and PinPak termination devices and RF connector devices. Controlled electrical cables and components are available for data bus systems. For further information see the Electrical Interconnect Products section of this catalog.

Small, Lightweight Twin Axial Cables

Product Facts

- Light weight, small size
- Temperature range of
-65°C to 200°C
[-85°F to 392°F]
- Low capacitance
- High data rates
- Excellent shop handling



Cheminax Twin Axial Cable



Applications

These small, lightweight cables are specially designed for use in MIL-STD-1553 data bus applications. Raychem materials technology allows the design and construction of cables that meet rigorous electrical and environmental performance requirements while minimizing size and weight.

Cheminax twin axial cables provide elegant solutions to an increasing range of data bus and multiplex signal transmission applications.

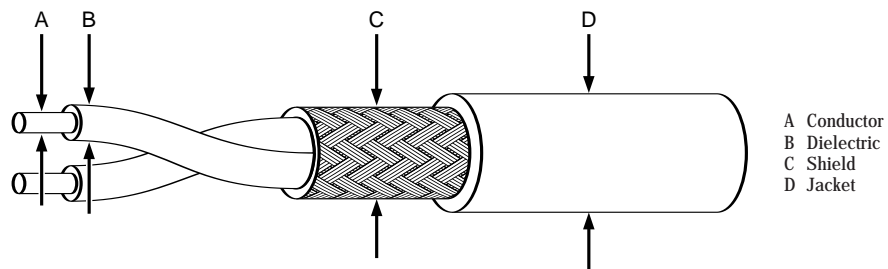

Available in:	Americas	Europe	Asia Pacific
	■	■	■

Cheminax Twin Axial Cable (Continued)

Specifications/Approvals

Series	Raychem
Cheminax cables	1200

Product Dimensions*

Typical Product Part No.	Impedance (ohms)	Capacitance pF/m(pF/ft)	A	B	C	D	Weight in kg/km (lb/1000ft)
			Conductor Diameter	Dielectric Diameter	Shield Diameter	Jacket Diameter	
5024A1661	50	104.7 [31.9]	.64 [.025]	0.89 [.035]	2.21 [.087]	2.62 [.103]	14.4 [9.7]
5026A1664	50	136.2 [41.5]	.48 [.019]	0.66 [.026]	1.75 [.069]	2.16 [.085]	10.0 [6.7]
7520A1662	75	74.2 [22.6]	1.02 [.040]	2.03 [.080]	4.60 [.181]	5.05 [.199]	42.9 [28.8]
7526J1660	75	88.6 [27.0]	.48 [.019]	0.99 [.039]	2.41 [.095]	2.82 [.111]	14.9 [10.0]
7820D0331	78	67.3 [20.5]	1.02 [.040]	2.11 [.083]	4.75 [.187]	5.72 [.225]	46.9 [31.5]
7824E0422	78	55.1 [16.8]	.64 [.025]	1.19 [.047]	2.82 [.111]	3.33 [.131]	19.6 [13.2]
0022E0311	100	49.2 [15.0]	.79 [.031]	1.98 [.078]	4.39 [.173]	5.16 [.203]	30.5 [20.5]
0024A0024	100	44.3 [13.5]	.64 [.025]	1.30 [.051]	3.02 [.119]	3.63 [.143]	25.1 [16.9]
0026A0024	100	44.0 [13.4]	.48 [.019]	1.14 [.045]	2.72 [.107]	3.23 [.127]	18.7 [12.6]
2524H0524	125	39.4 [12.0]	.64 [.025]	1.83 [.072]	4.09 [.161]	4.50 [.177]	25.3 [17.7]
2526E1114	125	36.1 [11.0]	.48 [.019]	1.40 [.055]	3.33 [.131]	3.73 [.147]	21.7 [14.6]
2530A0314	125	39.4 [12.0]	.30 [.012]	0.86 [.034]	2.16 [.085]	2.67 [.105]	10.6 [7.1]
10595-24	70	91.9 [28.0]	.64 [.025]	1.19 [.047]	2.82 [.111]	3.23 [.127]	17.9 [12.0]
10606-26	75	91.9 [28.0]	.53 [.021]	0.99 [.039]	2.41 [.095]	2.82 [.111]	13.4 [9.0]
10612-24	77	91.9 [28.0]	.64 [.025]	1.22 [.048]	2.90 [.114]	3.30 [.130]	23.7 [15.9]
10613-24	77	91.9 [28.0]	.64 [.025]	1.22 [.048]	3.33 [.131]	3.73 [.147]	39.0 [26.2]
10614-24	77	91.9 [28.0]	.64 [.025]	1.22 [.048]	3.73 [.147]	4.09 [.161]	40.3 [27.1]

*All dimensions are nominal.

Small, Lightweight Twin Axial Cables

Product Characteristics

General	Conductor range Operating temperature range*	20 AWG to 30 AWG -65°C to 200°C [-85°F to 392°F]
Electrical	Impedance range Capacitance range	50 ohms to 125 ohms 30 pF/ft to 10 pF/ft

*Temperature rating varies depending on materials used in specific construction.

Properties (per SCD)

Physical	Typical Value of Dielectric Material					
	Rayfoam L	Rayfoam H	Rayolin F	FEP (solid)	Radiation-Crosslinked XL ETFE	
Tensile (min.)	6.8 MPa (1000 psi)	9.1 MPa (600 psi)	12.2 MPa (1800 psi)	6.8 MPa (1000 psi)	34 MPa (5000 psi)	
Elongation (min.)	50%	50%	200%	150%	50%	
Electrical						
Dielectric withstand (min.)	1000 V	1000 V	1000 V	1000 V	1000 V	
Velocity of propagation (nom.)	78%	78%	67%	69%	61%	
Permittivity (nom.)	1.65	1.65	2.2	2.1	2.7	
Physical	Typical Value of Jacket Material					
	Thermorad	SPEC 55	FlexLine	FEP	Zerohal	SPEC 44
Tensile (min.)	13.6 MPa (2000 psi)	34 MPa (5000 psi)	20.4 MPa (3000 psi)	13.6 MPa (2000 psi)	8.2 MPa (1200 psi)	27.2 MPa (2500 psi)
Elongation (min.)	250%	50%	100%	200%	150%	150%
Temperature (max.)	125°C [257°F]	200°C [392°F]	200°C [392°F]	200°C [392°F]	125°C [257°F]	150°C [302°F]
Flammability**	Method C	Method B	Method B	Method B	Method B	Method B
Fluid category**	C	A	A	A	C	B

*See Raychem specification WCD-1200 for details.

Product Facts

- Temperature capability:
-55°C to +260°C [-67°F to +500°F]
- Small size, lightweight
- System compatibility with other Raychem products
- Complete range of components
- Specially formulated jacket materials
- Special shielding to address EMI/EMC problems
- Custom designed and purpose built
- Fast response—design, pricing, and delivery
- Prototype length facility
- Raychem Dynalink extended flex-life and increased flexibility
- Fire-resistant: circuit integrity (IEC331, enhanced 950°C [1742°F], 3 hours)
- Small-size, lightweight, low-fire-hazard for modern high-speed vessels



Available in:

- Americas ■
- Europe ■
- Asia Pacific ■

Specifications/Approvals

Multiconductor (Multicore) Cables

Custom-designed and standard Multiconductor (Multicore) Cables

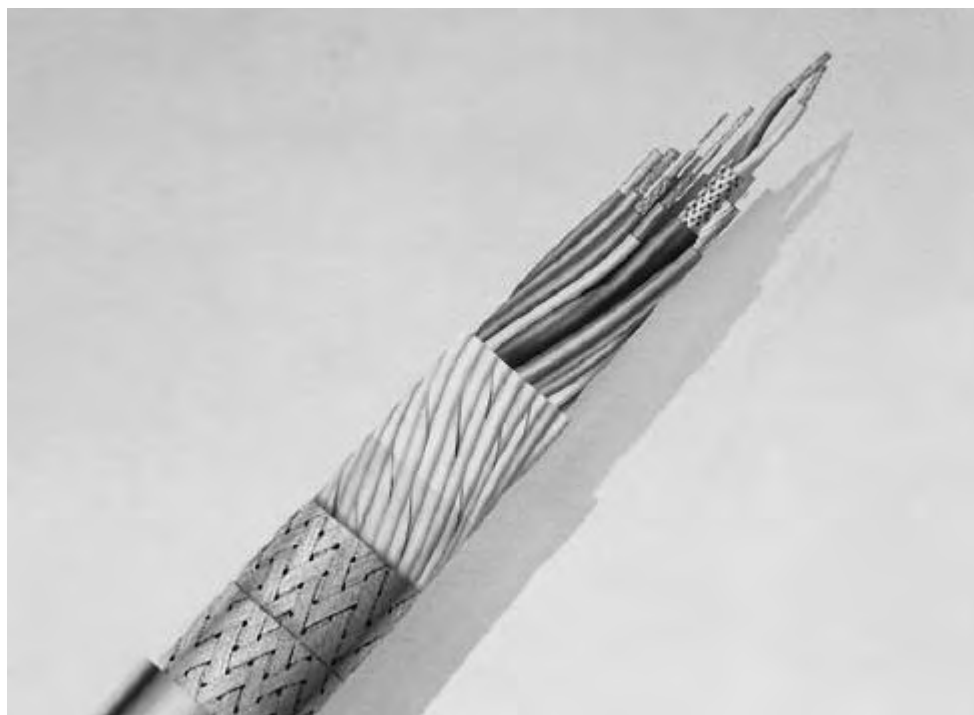

Applications

Tyco Electronics is the leading manufacturer of Raychem custom-designed, small-size, lightweight, high-performance multiconductor (multicore) cables. Applications are found in the aerospace, commercial marine, naval, mass transportation, automotive, offshore, military ground vehicle, ground support, high-performance instrumentation, industrial, and commercial markets. Raychem multiconductor (multicore) cables have been approved to many standards demanding high performance criteria in service use.

Multiconductor (Multicore) Cables Purpose Built and Designed Using Raychem Components and Technology

Multiconductor cables are used in widely varying applications and environments. Careful consideration must be given to the selection of components with the right combination of physical, chemical, and electrical properties for specific applications.

Tyco Electronics' leadership in the technologies of polymer blending and subsequent radiation crosslinking has led to the development of a particularly broad range of Raychem cables. High-performance component wires and miniature coaxial cables are combined with unique cable jacket materi-

als to meet the requirements of demanding environments.

Established as one of the leading manufacturers of special purpose Raychem cables, Tyco Electronics has continued to develop both its design and manufacturing expertise.

Development of a sophisticated CAD system has allowed increasingly rapid response to any design request, followed by manufacturing to the highest quality standards.

Planar Film-Bonded Cables

Tyco Electronics can custom-design and build a variety of Raychem component wires and cables onto high-performance carrier films. Components and carriers are matched to ensure temperature and environmental stability.

Agency	Industry	Military	Raychem
Underwriters' Laboratories	Lloyd's Register of Shipping	Def. Stan. 61-12 Pt 25	WCD series
BSENISO9001	Det Norske Veritas	VG 95218 Pts 27 and 28	—
MSV 34410-34413, 34435,34436	—	—	—

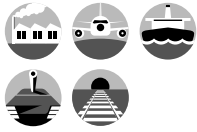

Multicore Cables



Design Flexibility

Components

- SPEC 44 wire and cable
- SPEC 55 wire and cable
- Type 99 wire and cable
- 100 wire
- Coaxial cables
- ElectroLoss FilterLine cables
- Flexible power cables
- Optical fibers
- Special components

Wraps and Braids

- Fabric and film tapes
- Kevlar® or steel strength members
- Full range of electrical screens (including SuperScreens)

Jacket Materials

- FDR 25 - Fluid resistant, flexible, high temperature
- Thermorad - General purpose
- Thermorad HTF/ - Very high temperature, Fluoroelastomer fluid resistant
- Raythane C - Tough and flexible
- Raythane FR - Tough, flexible, flame-retardant
- Rayolin - Low moisture transmission
- Neoprene - Low-temperature flexibility
- Zerohal - LFH

KEVLAR is a trademark of E. I. du Pont de Nemours and Company

Properties and Specifications

Specifications and Approvals (Components and Jacket Materials)

Specifications UK Designation	FDR 25	Zerohal	Fluoro- elastomer	Thermorad	Rayolin	Raythane C	AFR	Neoprene	44 Wire	55 Wire	100 Wire	99 Wire	Hytrel
US Designation		Zerohal	Thermorad HTF	Thermorad F		Raythane FR		Thermorad NTFR	44 Wire	55 Wire	100 Wire		
Def Stan 61-12 Part 31 (NES 518)		X											
Def Stan 61-12 Part 25		X							X				
Def Stan 61-12 Part 18 type 1 (issue 4) (Maintenance range)									X				
Def Stan 61-12 Part 18 type 1 (issue 4)		X										X	
Def Stan 61-12 Part 25		X										X	
Def Stan 61-12 Part 26									X				
34435, 34436		X							X				
VG 95218 Part 20, 21, 22 and 23									X	X			
VG 95218 Part 24, 25 and 26	X												
VG 95218 Part 27 and 28	X	X							X		X		
VG 95218 Part 1000									X				
VG 95218 Part 1001 and 1002										X			
MIL-C-24640 (PMS 400)		X							X				
MIL-W-81044/MIL-C-27500									X				
MIL-W-22759/MIL-C-27500										X			
A014000		X											X
O2-517		X			X				X				
Approvals													
Lloyds Register of Shipping/DNV		X		X		X			X				X
Bureau Veritas	X	X	X	X		X	X	X	X	X			
UL				X		X (FR)	X		X	X			
CAA									X	X			
BWB	X			X					X	X			
VDE	X			X					X	X			
Det Norskeveritas													
Germanischer Lloyds		X										X	
American Bureau of Shipping		X										X	
Lloyds		X										X	
Bureau Veritas		X										X	

Major Cable Specifications

Country	Cable Specification	Specification Description	Approved Jacket
UK	Def Stan 61-12 Part 25	Royal Navy specification covering limited fire hazard thin-wall insulated electric cables using Def-Stan 61-12 Part 18 approved wire. Signal, control and light power circuits.	Zerohal
Germany	VG 95218 (parts 27 and 28)	Military ground systems specification for signal, control and power cables. Wire to VG 95218 Parts 20-23 and 1000.	FDR-25
USA	MIL-C-24640 (PMS 400)	Navy specification covering limited fire hazard thin-wall insulated electric cables for signal, control and light power circuits. Wire to MIL-W-81044.	Zerohal

Summary of Typical Cable Jacket Properties

UK Designation	US Designation	Property				Chemical Resistance		
		Temperature Range °C*	Abrasion Resistance	Flexibility	Flame Resistance	Acid	Alkaline	Hydrocarbon
FDR25	—	-40 to 150	Fair	Very good	Self-ext;ing	Good	Good	Very Good
Zerohal	Zerohal UK & US	-30 to 105	Good	Good	Self-ext;ing	Good	Good	Good
Fluoroelastomer	Thermorad HTF	-20 to 200	Good	Good	Nonburning	Excellent	Excellent	Excellent
Thermorad	Thermorad F	-55 to 125	Good	Good	Self-ext;ing	Good	Good	Good
Raythane C	—	-25 to 80	Excellent	Excellent	Self-ext;ing	Fair	Fair	Excellent
—	Raythane FR	-65 to 90	Excellent	Excellent	Self-ext;ing	Fair	Fair	Excellent
Neoprene	Thermorad NTFR	-55 to 110	Very Good	Excellent	Self-ext;ing	Good	Good	Good
Rayolin	—	-55 to 95	Very Good	Fair	—	Good	Good	Good
AFR	—	-40 to 105	Excellent	Good	Self-ext;ing	Good	Good	Good
—	Thermorad LS	-30 to 105	Good	Good	Self-ext;ing	Good	Good	Good
—	Thermorad O	-55 to 125	Good	Good	Self-ext;ing	Good	Good	Good
—	Thermorad 300	-65 to 200	Very Good	Fair	Self-ext;ing	Excellent	Excellent	Excellent
Polyvinylidene Fluoride	Thermorad K	-65 to 150	Very Good	Fair	Self-ext;ing	Excellent	Good	Excellent
Modified ETFE	Thermorad HT	-65 to 200	Very Good	Fair	Self-ext;ing	Excellent	Excellent	Excellent
Modified Flexible ETFE	Thermorad FL	-55 to 200	Very Good	Good	Self-ext;ing	Excellent	Excellent	Excellent

*Operating temperatures for cables are application dependent. Figures shown are for guidance only. In many cases the limits shown may be extended at both ends of the temperature range. Consult Tyco Electronics for guidance.

Flexible, Diesel Resistant Wire and Cable Jacket Material

Product Facts

- Highly flame retardant
- Compatible with Raychem System 25 tubing, molded parts and adhesives
- Qualified to VG standards

FDR25

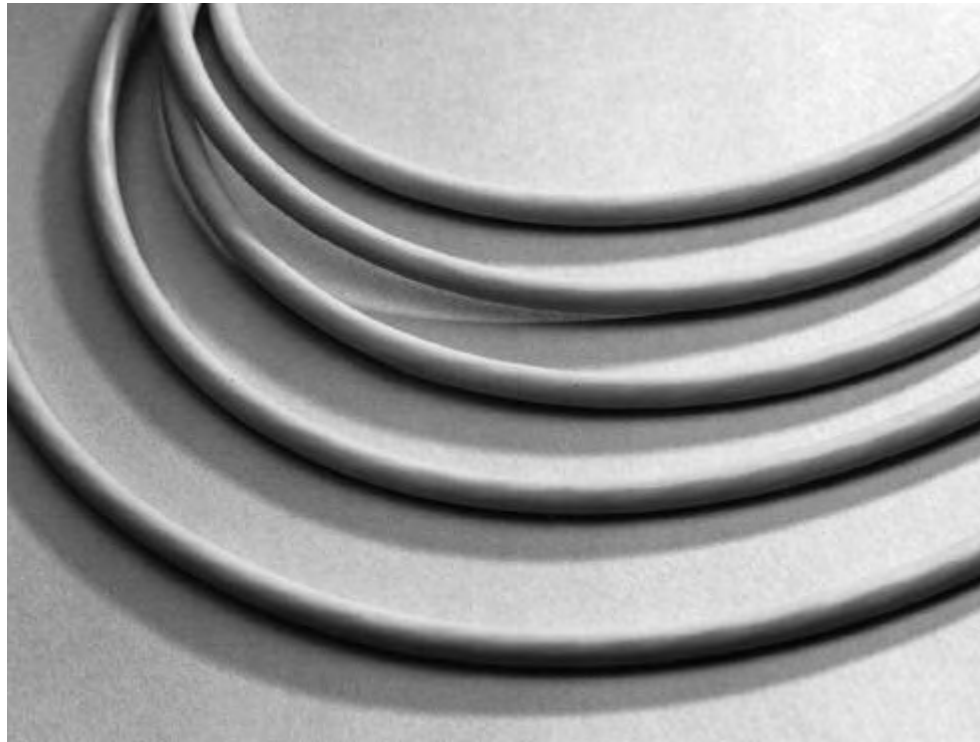

Available in:

- Americas ■
- Europe ■
- Asia Pacific ■

Applications

FDR 25 cable jacket was originally developed for the Leopard II main battle tank to provide an exceptional range of properties. Used in compartments exposed to hot diesel fuels and vibration, FDR 25 resists a wide range of aggressive fluids and offers excellent low temperature flexibility. These properties have also led to a widespread use of FDR 25 on other military vehicles and in many applications such as test and communications equipment. FDR 25 is fully compatible with Raychem's high performance harnessing system — System 25.

Operating Temperature Range

-40°C to 150°C
[-40°F to 302°F]

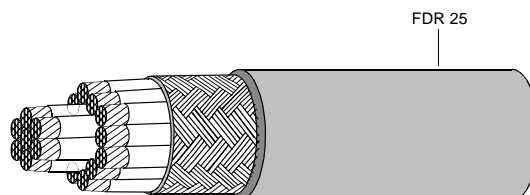

Typical Characteristics when Tested in Accordance with Raychem Specification WCD 2002 (UK) and WCD 3304 (US)

Mechanical	Tensile strength (MPa)	20	
	Elongation (%)	500	
	Tear strength (N/mm)	5	
	Abrasion resistance (1.6 kg load)	40 scrapes min.	
	Cold bend	-40°C [-40°F]	
Thermal aging	Endurance IEC 216	2500 h 150°C [302°F]	
	Heat aging 120h, 175°C [347°F]	TS 8 MPa (min). Eb 150% (min)	
	Heat shock 4 h at 225°C [437°F]	No cracks, drips or flowing, 6 mm total shrinkage in 300 mm	
Fluid resistance	24 h immersion	% Retention of properties	
		Tensile strength	Elongation
	Diesel fuels 70°C [158°F]	70	70
	Hydraulic fluids 50°C [122°F]	70	70
	Lubricating oils 100°C [212°F]	70	80
	Cleaning fluids 23°C [73°F]	90	95
Electrical	Deicing fluids 23°C [73°F]	90	95
	Insulation resistance 20°C [68°F] M ohm.km min.	2	
Other	45° flammability	30 s (max) afterburn 100 mm (max) burn length	
	Vertical flammability	Self extinguishing	
	Acid gas	4% HCl equivalent (max.)	

Low Fire Hazard
Performance Wire and
Cable Jacket Material

Product Facts

- Halogen free
- Low smoke generation
- Highly flame retarded
- Low toxicity index
- Low corrosive gas emission
- Temperature rating -30°C to +105°C [-22°F to +221°F]



Available in:

- | | |
|--------------|---|
| Americas | ■ |
| Europe | ■ |
| Asia Pacific | ■ |

Zerohal



Applications

Cables rarely initiate fires, but they could be involved in them and can significantly increase the damage caused should they propagate the fire. Until recently the flame retarding of cables was achieved by the use of halogenated flame retardants which are effective fire suppressants, but which unfortunately produce dense smoke and corrosive acid gases when burned. These effects are highly undesirable in a fire, hindering evacuation and fire fighting, endangering life and causing corrosion damage to expensive and vital equipment.

Raychem Zerohal is a halogen-free cable jacket material developed by Tyco Electronics and approved to the most exacting requirements for low fire hazard cables in many countries and, as such, is the most widely accepted material for these applications in the marine, process and mass transport industries. Combined with SPEC 44 wire or Type 99 and 100 wire, this jacket material provides small size, light weight cables (approximately 40% weight saving over conventional materials).

Zerohal combines the good mechanical and electrical features of some conventional cables with good flame retardancy, low smoke generation, low evolution of hazardous and corrosive gases, and good resistance to diesel fuel, lubricating oils and water.

Zerohal jacket material is fully compatible with the low fire hazard harnessing system - System 100.

System

- System 100

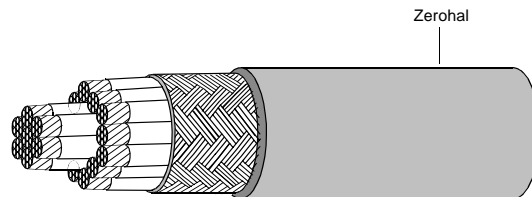

Zerohal (Continued)

Product Characteristics when Tested in Accordance with Raychem Specification WCD 2015 and WC 2001 (Zerohal with Fungicide)

Mechanical	Tensile strength (MPa)	8
	Elongation (%)	200
	Tear strength (N/mm)	5
	Abrasion resistance (1.6 kg load)	30 scrapes min.
	Cold bend	-30°C [-22°F]
Thermal aging	Heat aging 120 h 130°C [266°F]	60% min retention of TS and Eb
	Heat shock 4 h at 225°C [437°F]	No cracks, drips or flowing, 6 mm total shrinkage in 300 mm
Retention of properties		
Fluid resistance		Tensile strength Elongation
	Diesel fuels 100°C [212°F] /24 h	85 75
	IRM 902 24h, 100°C [212°F]	90 75
	Lubricating oils 50°C [122°F]/24 h	80 75
	Water uptake (ASTM D570) 70°C [158°F]/28 days	2% weight uptake (max)
Electrical	Insulation resistance 20°C [68°F] M ohms km (min)	40
	45° flammability	Self extinguishing
Other	Vertical flammability (Swedish Chimney)	Self extinguishing
	Acid gas	1.2% HCl equivalent (max)
	Limiting oxygen index	32%
	Temperature index	275°C [527°F]
	Toxicity index	2.5 per 100 g
	Smoke index	18
	Halogen content	None detected

**Low Fire Hazard Performance
Flammability**

Current thinking on fire hazard defines the term 'Fire Risk'. This description recognizes that the risk in a fire situation is influenced strongly from several factors including, ignitability, heat release, smoke evolution and toxic gas emission together with flammability.

There are several test procedures available used to assess flammability of wires and cables. Still in widespread use is Limiting Oxygen Index (LOI), but it is now generally recognized that because the test is conducted on a single specimen (of cable jacket or wire) in laboratory conditions, the results are, at best, only weakly correlated to actual fire situations. Critical Temperature Index (CTI), is a related test and assesses performance at elevated temperature but nevertheless it is still conducted on a single specimen. More recent evidence

and thinking places significantly greater importance on large scale flammability tests, such as IEC 60332-3, in which the sample consists of several bundles of wires. These tests predict more accurately the likely behavior of cables in actual fire scenarios. Raychem Zerohal cable jackets give very good results in small scale laboratory based tests (e.g. LOI, CTI) and Zerohal cables perform very well in large scale tests (e.g. IEC 60332-3). Overall Zerohal jacketed cables have been shown to exhibit excellent flammability characteristics.

Corrosivity

Under fire conditions, polymers containing halogens, sulphur and phosphorous all form corrosive acid gases or liquids. These acids can then attack items such as printed circuit boards, connectors, control relays and metal structures, including steel reinforcement bars embedded in concrete.

Test methods to evaluate corrosivity involve direct measurement of the amount of acid gas produced during pyrolysis, eg to British Rail Specification TDE 76/P/16 or measurement of pH and electrical conductivities of solutions.

Toxicity Index

The various gases given off by combustion of polymeric materials are toxic to differing degrees.

The Def Stan 02-713, assesses the concentration of each of the possible by-products and, by measuring the amounts of these materials, a Toxicity Index is assigned.

Zerohal jacket material has a typical Toxicity Index of 1.7, compared to a typical value of 6 for CSP and 20 for PVC jacketed cable. The Def Stan 61-12 part 31 specification requirement for a cable jacket is <5.

Smoke

The problems of classifying flammability and corrosive gas generation equally apply to measuring smoke generation. The method accepted by most authorities involves the use of the NBS smoke chamber where optical density of the chamber's atmosphere is constantly measured during pyrolysis.

The 10% visibility line indicates the density of smoke which would cause human disorientation and confusion. The rate of change of smoke density can be summarized to a single numerical value, as in NES 711, to give a smoke index for a material and thus offers simple comparison of materials performance.

Zerohal (Continued)

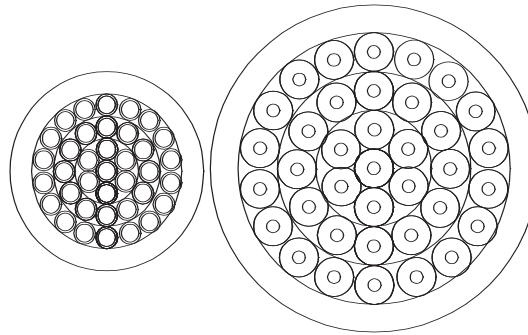

	Raychem Cable to Def Stan 61-12 Pt25	Cable to DGS 212
Diameter	12.5 mm (nom.)	21.3 mm
Weight	328 g/m (nom.)	526 g/m
Conductor	0.60 mm ² (nom.)	0.5 mm ²

Ships are becoming smaller and more sophisticated, with an ever increasing complexity of electronic systems, sensors and weapons. As technology advances shipbuilders are called upon to update and modify existing systems or fit completely new ones. The proliferation of electronic hardware requires more and more communication systems to transfer data from one place to another. To provide all the necessary interconnections, hundreds of multicore cables have to run throughout the ship. These, along with cables for power, lighting and other basic services, create a severe space problem within ducts and hangers. For the vessel to achieve maximum speed, maneuverability and range, it is vital to

keep the "top weight" to a minimum and since most of the equipment is located on the upper decks, system weight must be kept as low as possible.

The diagram shows a lightweight cable compared with a traditional Navy cable having the same cross-sectional area of copper. Both cables have the same number of conductors. A saving in size has been made on the insulation material, but without sacrificing the mechanical or electrical characteristics of the cable. A typical saving in cable tray volume could be as high as 40%. Lightweight cables can also save in excess of twenty tons on a typical frigate and three to five tons on a fast patrol boat.

Raychem lightweight, small size cables are giving reliable service in frigates, corvettes, fast patrol boats, hydrofoils and submarines in many major Navies.

Due to recent improvements in manufacturing, Raychem can now offer an even tighter tolerance of $\pm 2.5\%$ on cable diameter. This is well within the limits imposed by specifications such as Def Stan 61-12 part 25, and offers significant benefits to system designers, particularly where cable glanding is involved.

Weight savings within "maxima allowed" by existing specifications are also achievable.

Other applications

The increasing awareness of many areas of industry of the need to minimize fire hazard risk is leading to a rapid growth in the use of Zerohal jacketed cables. Applications include rail and mass transit, offshore platforms and other enclosed areas where a fire would present a significant threat to people or equipment.

High Temperature Performance Wire and Cable Jacket Material

Product Facts

- High temperature capability
-20°C to +200°C [-4°F to 392°F]
- Excellent chemical resistance
- Flame retardant
- Continuous aircraft fuel immersion



Available in:

- Americas ■
- Europe ■
- Asia Pacific ■

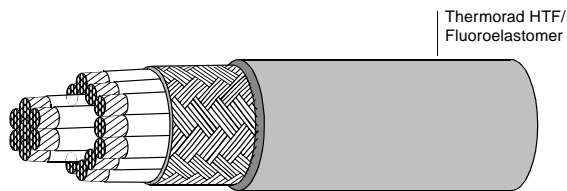

Thermorad HTF/ Fluoroelastomer



Applications

Thermorad HTF/ Fluoroelastomer is a material specially formulated for use in applications where exceptional performance is required.

It displays excellent stability during continuous high temperature exposure to adverse chemical environments.

Thermorad HTF/ Fluoroelastomer has a continuous operating tempera-

ture of up to 200°C [392°F], and finds applications in aircraft fuel tanks and on high performance engine cables. Thermorad HTF/ Fluoroelastomer cable jackets are compatible with the Raychem high temperature harnessing systems — System 200.

System

- System 200

Typical Characteristics when Tested in Accordance with Raychem Specification WCD 51/367

Mechanical	Tensile strength	12 MPa	
	Elongation	400%	
	Abrasion resistance (1.6 kg load)	40 scrapes min.	
	Cold bend -0°C ± 3°C [37°F]	No cracking	
Thermal aging	Heat age	168 h 250°C [482°F]	
	Heat shock 4 h at 300°C ± 3°C [572°F ± 37°F]	No cracks, drips or flowing, 6 mm total shrinkage in 300 mm	
Fluid resistance	72 h immersion	% Retention	
	Diesel oil 100°C [212°F]	Tensile strength	Elongation
	ASTM No 2 oil 100°C [212°F]	60	60
Electrical	Insulation resistance 20°C [68°F] M ohms. km (min)	10	
Other	45° flammability	30 s (max) afterburn 100 mm (max) burn length	
	Vertical flammability	Self extinguishing	

General Purpose Wire and Cable Jacket Material

Product Facts

- Temperature rating -55°C to +125°C [-67°F to 257°F]
- Highly flame retardant
- Resistant to fuels, oils and greases
- Resistant to NBC decontaminant
- UL approved



Available in:

- Americas ■
- Europe ■
- Asia Pacific ■

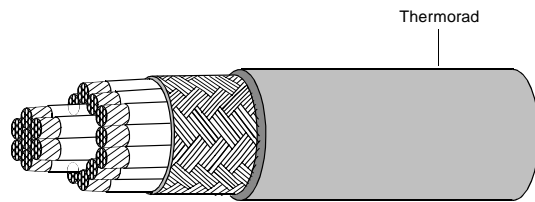

Typical Characteristics when Tested in Accordance with Raychem Specification WCD 51/1602 (UK) and WCD 3310 (US)

Mechanical	Tensile strength	22 MPa		
	Elongation	550%		
	Abrasion resistance (1.6 kg load)	300 scrapes min.		
Thermal aging	Cold bend	-55°C [-67°F]		
	Heat aging 120 h, 170°C [338°F]	60% min. retention of TS and Eb		
	Heat shock 4 hours at 225°C [437°F]	No cracks, drips or flowing, 6 mm total shrinkage in 300 mm		
Fluid resistance	% Retention of properties			
	72 hour immersion, 50°C [122°F]	Tensile strength		Elongation
	IRM 902	60		60
	Skydrol®	60		60
Electrical	Insulation resistance 20°C [68°F]	100		
Other	45° flammability	30 s (max.) afterburn 75 mm (max.) burn length		
	Acid gas	4% HCl equivalent (max.)		

Thermorad/Thermorad F



Applications

Thermorad is a general purpose jacket material which is unaffected by most common chemicals and solvents and is suitable for use during N.B.C. decontamination. Thermorad is highly flame retardant and has an overall balance of physical and chemical properties.

Thermorad cables find widespread use in industrial, commercial and military applications. This includes railways, commercial vehicles, medical equipment, communication equipment and commercial electronics. Thermorad cable jackets are compatible with Raychem polyolefin tubings, molded parts and adhesives.

Specialized Wire and Cable Jacket Material

Product Facts

Raythane C

- -25°C to +80°C
[-13°F to +176°F]

and Raythane FR

- -65°C to +90°C
[-85°F to +194°F]
- Mechanically tough
- Can be overmolded

Rayolin

- -55°C to +95°C
[-67°F to +203°F]
- Excellent long term water immersion
- Can be overmolded
- Compatible with Raychem's underwater cable splices

Neoprene (US designation Thermorad NTFR)

- -55°C to +90°C
[-67°F to +194°F]
- Extreme flexibility
- Highly flexible at low temperatures

AFR

- -40°C to +105°C
[-40°F to +221°F]
- Abrasion resistant
- Fuel resistant
- Flame retardant



Applications

In addition to the preferred cable jacket materials, Tyco Electronics offers a variety of Raychem cable jackets for specialized applications. For example, specialized materials are available for extreme low temperature flexibility or for enhanced abrasion resistance, or non-cross-linked materials for cable splicing or overmolding.



Available in:

- Americas ■
- Europe ■
- Asia Pacific ■

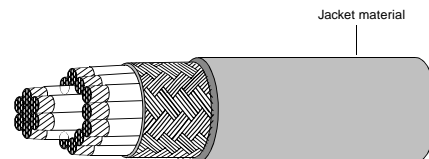

Typical Characteristics when Tested in Accordance with Raychem Specification WCD

	WCD51/1625 Raythane C	WCD3310 Raythane FR	WCD51/147 Neoprene*	WCD51/1601 Rayolin	WCD51/1619 AFR	
Mechanical	Tensile strength (MPa)	45	45	14 12	150	
	Elongation (%)	400	400	400	250	
	Abrasion resistance (1.6 kg load)	500 scrapes	500 scrapes	30 scrapes	300 scrapes	200 scrapes
	Cold bend	-25°C [-13°F]	-15°C [5°F]	-55°C [-67°F]	-55°C [-67°F]	-40°C [-40°F]
Thermal aging	Endurance (10000 h)	80°C [176°F]	90°C [194°F]	90°C [194°F]	95°C [203°F]	105°C [221°F]
Fluid resistance	24 h immersion Diesel fuels 50°C [122°F]	Excellent	Excellent	Good	—	Good
	Skydrol® 50°C [122°F]	—	—	Excellent	Excellent	Excellent
	IRM 902 100°C [212°F]	Excellent	Excellent	Good	Good	Good
Electrical	Insulation resistance 20°C [68°F] M ohms. km (min)	1	1	5	100	100
Other	45° flammability	Pass	Pass	Pass	—	Pass

* In the US use Thermorad NTFR to WCD 3314.

Electrical Shielding



Available in:	
Americas	■
Europe	■
Asia Pacific	■

Applications

In many applications, shielding of cables is important, whether it be to minimize cross-talk within the cable, to prevent interference from external sources, or to eliminate radiation from the cable itself.

The design of cables to provide effective shielding over a broad frequency spectrum is complex, and cables must be tailored to







specific electromagnetic environments. From simple aluminized Mylar® film that provides electrostatic shielding, progressively more complex shielding can be designed incorporating plated copper braids and Mu metal wraps.

Optimization

Performance of conventional braiding can be significantly improved by computer optimization. This tightly controlled

process can give many times the shielding performance of a basic braided shield with minimal weight penalty or increase in optical coverage. Supershielded cables combine Mu metal wraps with optimized braids to provide even further enhanced performance, especially at low frequencies.

Available Shields

Shield type	Construction	Typical Application
Aluminized Mylar®		Electrostatic shielding
Single Braid		Low level EMI Low sensitivity
Single Optimized Braid		Sensitive lines High EMI
Double Optimized Braid		Highly sensitive lines Severe EMI
Supershielded		EMP/Tempest
Double Supershielded		Severest of applications

MYLAR is a trademark of Dupont Teijin Films U.S.

Electrical Shielding (Continued)

Measuring Shielding Efficiency

Surface Transfer Impedance (Zt)

To assess the effectiveness of a shield, Tyco Electronics has adopted the line injection method as described in IEC 1196-1 to measure the surface transfer impedance (Zt) of a cable shield. This relates the open circuit voltage generated on a component wire inside the cable to the current injected on the overall shield. The unit of Zt is Ohms per meter, thus the voltage coupling is length dependent and long cables exhibit more leakage than similar but shorter length ones. To determine the surface transfer impedance across a range of frequencies, a drive signal is generated by the internal tracking generator of a spectrum analyzer, and amplified. The voltage is induced on the center conductor of the sample which is amplified and returned to the signal generator for measurement. The understanding of leakage mechanisms has enabled Tyco Electronics to design Raychem cables with guaranteed minimum Zt values for the desired operating environment.

Supershielding

EMP Hardened Cables

The requirements for nuclear hardened cables present the engineer with a range of problems. The waveform of the EMP is such that the majority of power is dissipated in a frequency band between 1 KHz and 5 MHz, where little protection is given by conventionally shielded cables. Tyco Electronics has solved this problem with a range of

supershielded cables which give shielding performance at these frequencies by incorporating materials which change the inductance of the shield and lower the transfer impedance. Raychem supershielded cables have a sandwich construction of Mu metal tapes between optimized braids. Mu metal is a ferro-magnetic material which has a high permeability over a wide range of field strengths. It is applied to the cable in a way which maintains cable flexibility and minimizes work hardening and any consequent reduction in permeability. Supershielded cables not only give protection against EMP but also other major interference modes.

Design and Manufacturing Expertise

The problems of shielding cables are complex. However, with the introduction of optimized braids and supershielded cables, Tyco Electronics has the capability to solve the most difficult shielding problems. Shielding of cables without degrading cable flexibility can be provided for coaxial and multiconductor cables for all EMC and EMP conditions. To complement this range of cables, Tyco Electronics manufactures Raychem cable terminations and connector back fittings to give total interconnection system shielding performance.

Shielded Cables

Controlling the Threat

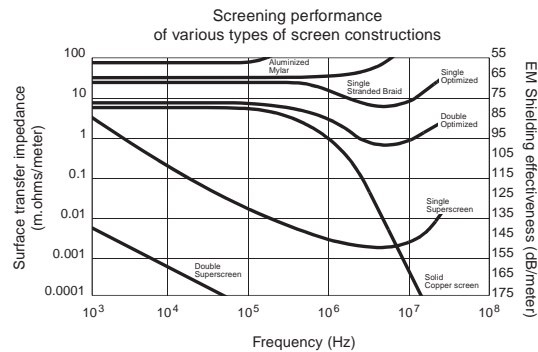

Testing

Tyco Electronics EMC test facilities have the capability for bulk current injection and radiation field testing in addition to surface transfer impedance measurements. The installation is a proven facility in characterizing new design parameters.



Applications

Every year, Tyco Electronics designs and builds several thousand custom, high-performance, multiconductor cables that meet unique product needs.

Design staff can draw on an extensive range of high-performance cable components and jacket materials, while incorporating both color-coding and alphanumeric marking techniques for component identification. These options, combined with a full range of EMI shields, lead to a huge variety of construction possibilities.

Tyco Electronics developed computer-aided design tools to provide a fast response to design requests. The software, used by factory engineers or product specialists in the field, can generate cable design proposals with drawings and quotations in minutes. A design drawing details all the cable data and can be used as the input to harness or cable splice (joint) design. The resulting cable is tailored to customers' exact needs in an efficient design that is superior to the compromise cable selected from a product catalog.

Quality Assurance

Raychem WCD and WSD cable specifications ensure that performance and quality standards are maintained to the highest level. Tyco Electronics manufacturing sites have obtained the highest available quality system approvals, including ISO 9000 and QS9000. Raychem cables are manufactured to meet the requirements of several major specifications.

Available in:	
Americas	■
Europe	■
Asia Pacific	■

Power Cables

Product Facts

- Choice of jacket materials
- -55°C to +125°C
[-67°F to +257°F]
- Size and weight savings
- Excellent flexibility
- Resistance to solvents and chemicals



Applications

Tyco Electronics offers a range of flexible Raychem power cables that are insulated and jacketed using materials that provide improved performance over other materials, such as CSP/EPR, silicone, or PCP/Butyl. Four different types of cable are available:

Type TR is a general purpose, single-wall, 125°C [257°F] construction normally specified for use inside cabinets in protected areas.

Type ZHI is a halogen-free 105°C [221°F] cable with good oil resistance. It is particularly suitable for use in offshore, ship, and mass transit applications where low-fire-hazard performance is required. Refer to Raychem specification WCD 2015.

Type FTR is a dual-wall, 125°C [257°F], diesel-oil-resistant cable originally developed for tank engine compartment applications. It meets the German BWB VG 95218 specification. Refer to Raychem specification WCD 2002.

Type AFR is a 105°C [221°F], single-extrusion, abrasion-resistant, flame- and fuel-resistant, radiation-crosslinked polyolefin.

Type ZHPCG is a halogen-free, 115°C [239°F] cable with good oil resistance and resistance to water. It is particularly suitable to the Mass Transit, Marine and Off-Shore industries where its low fire hazard performance and flexibility are key to a successful installation. Refer to Raychem Specification WSD 1265.

Each offers particular advantages for specific applications and each is also available in multiconductor constructions and shielded and jacketed versions. Cables offer size and weight savings, good resistance to abrasion and cut-through, and the ability to operate in difficult environments.

Available in:

- Americas ■
- Europe ■
- Asia Pacific ■

Specifications/Approvals*

Series	Agency	Military	Raychem
TR	—	Def. Stan. 61-12 Part 31 (jacket material)	WCD 2003, WCD 51/160
ZHI	—	—	WCD 2015
FTR	—	BWB VG 95218 Types G, H, and K	WCD 2002
AFR	UL style 3496	—	WCD 2011, WCD 51/160
ZHPCG	—	—	WSD 1265

*See specifications listed for details of performance.

Conductors (Tinned Soft Copper)

Conductor Size mm ²	Stranding				Max. Resistance at 20°C in Ω/km (Ω/1000 ft) Class 5/6
	IEC Class 5		IEC Class 6		
	No. x mm	Nom. Dia.	No. x mm	Nom. Dia.	
1.5	30 x 0.25	1.49 [.05]	85 x 0.15	1.53 [.06]	13.20 [4.02]
2.5	50 x 0.25	1.90 [.07]	140 x 0.15	2.40 [.09]	7.82 [2.38]
4.0	56 x 0.30	2.49 [.10]	228 x 0.15	2.90 [.11]	4.85 [1.48]
6.0	84 x 0.30	3.00 [.12]	189 x 0.20	3.60 [.14]	3.23 [0.98]
10.0	80 x 0.40	4.60 [.18]	324 x 0.20	4.55 [.18]	1.88 [0.57]
16.0	126 x 0.40	5.70 [.22]	513 x 0.20	5.50 [.22]	1.19 [0.36]
25.0	196 x 0.40	7.10 [.28]	783 x 0.20	7.30 [.29]	0.78 [0.24]
35.0	276 x 0.40	8.50 [.33]	1107 x 0.20	8.55 [.34]	0.55 [0.17]
50.0	396 x 0.40	10.30 [.41]	702 x 0.30	10.15 [.40]	0.39 [0.12]
70.0	360 x 0.50	12.40 [.49]	999 x 0.30	12.00 [.47]	0.27 [0.08]
95.0	475 x 0.50	14.50 [.57]	1332 x 0.30	14.05 [.55]	0.20 [0.06]
120.0	608 x 0.50	16.00 [.63]	1702 x 0.30	16.30 [.64]	0.15 [0.05]
150.0	777 x 0.50	18.00 [.71]	2109 x 0.30	17.40 [.68]	0.13 [0.04]
185.0	925 x 0.50	20.00 [.79]	2590 x 0.30	20.00 [.79]	0.10 [0.030]
240.0	1221 x 0.50	23.00 [.91]	—	—	0.08 [0.024]
300.0	1554 x 0.50	26.00 [1.0]	—	—	0.06 [0.018]
400.0	2035 x 0.50	30.00 [1.2]	—	—	0.05 [0.015]

Note: Types TR and FTR use IEC Class 6 conductors.
Types ZHI and AFR use IEC Class 5 conductors.

Materials Performance Summary

Material	Tensile Strength N/mm ² typical	Abrasion Resistance	Cut Through	Temperature Rating °C 10000 h	Preferred Color
TR	20	Excellent	Good	125	Black
ZHI	9	Good	Very Good	105	Black
FTR	18	Good	Good	125	Black
AFR	18	Excellent	Very Good	105	Grey
ZHPCG	8	Good	Good	115	Black

Note: Where a higher operating temperature is required, Raychem SPEC 55 provides outstanding performance up to 200°C continuous operating temperature. For these or other special applications, please contact Tyco Electronics.

Table 1. Nominal Diameters and Maximum Weights

Conductor Size (mm ²)	TR 16			FTR 16		
	Part No.	Nom. OD in mm (in)	Max. weight in kg/km (lb/1000 ft)	Part No.	Nom. OD in mm (in)	Max. weight in kg/km (lb/1000 ft)
1.5	—	—	—	—	—	—
2.5	TR 16-2.5	3.9 [.15]	34.0 [22.8]	—	—	—
4.0	-4	4.5 [.17]	51.0 [34.2]	FTR 16-4	5.6 [.22]	69.0 [46.2]
6.0	-6	5.2 [.20]	73.0 [48.9]	-6	6.3 [.25]	94.0 [63.0]
10.0	-10	6.2 [.24]	117.0 [78.4]	-10	7.5 [.29]	147.0 [98.5]
16.0	-16	7.4 [.29]	182.0 [121.9]	-16	8.8 [.35]	220.0 [147.4]
25.0	-25	9.3 [.37]	274.0 [183.6]	-25	10.7 [.42]	323.0 [216.4]
35.0	-35	10.6 [.42]	383.0 [256.6]	-35	12.1 [.48]	444.0 [297.5]
50.0	-50	12.5 [.49]	542.0 [363.1]	-50	14.0 [.55]	619.0 [414.7]
70.0	-70	14.6 [.57]	765.0 [512.6]	-70	16.2 [.64]	861.0 [576.9]
95.0	-95	17.0 [.67]	1020.0 [683.4]	-95	18.8 [.74]	1148.0 [769.2]
120.0	—	—	—	-120	21.3 [.84]	1484.0 [994.3]

Table 2. Nominal Diameters and Maximum Weights

Conductor Size (mm ²)	ZHI 15			AFR 35		
	Part No.	Nom. OD in mm (in)	Max. Weight in kg/km (lb/1000 ft)	Part No.	Nom. OD in mm (in)	Max. Weight in kg/km (lb/1000 ft)
1.5	ZHI 15 -1.5	4.09 [.16]	33.5 [22.4]	AFR 35-1.5	2.8 [.11]	31.0 [20.8]
2.5	-2.5	4.69 [.18]	48.8 [32.7]	-2.5	3.9 [.15]	42.0 [28.1]
4.0	-4	5.49 [.22]	72.1 [48.3]	-4	4.8 [.19]	61.0 [40.9]
6.0	-6	6.16 [.24]	99.8 [66.9]	-6	6.2 [.24]	92.0 [61.6]
10.0	-10	8.20 [.32]	159.0 [106.5]	-10	7.0 [.28]	143.0 [95.8]
16.0	-16	9.30 [.37]	223.0 [149.4]	-16	8.1 [.32]	211.0 [141.1]
25.0	-25	10.90 [.43]	331.0 [221.8]	-25	10.3 [.41]	333.0 [223.1]
35.0	-35	12.30 [.48]	448.0 [300.2]	-35	11.7 [.46]	452.0 [302.8]
50.0	-50	14.70 [.58]	631.0 [422.8]	-50	13.7 [.54]	634.0 [424.8]
70.0	-70	16.80 [.66]	852.0 [570.8]	-70	16.0 [.63]	885.0 [593.0]
95.0	-95	19.10 [.75]	1108.0 [742.4]	-95	18.5 [.73]	1165.0 [780.6]
120.0	-120	21.00 [.83]	1438.0 [963.5]	-120	20.4 [.80]	1480.0 [991.6]
150.0	-150	23.00 [.91]	1748.0 [1171.2]	-150	22.6 [.89]	1825.0 [1222.8]
185.0	-185	25.60 [1.01]	2088.0 [1399.0]	-185	24.8 [.98]	2215.0 [1484.1]
240.0	-240	28.60 [1.13]	2705.0 [1812.4]	-240	27.8 [1.1]	2875.0 [1926.3]
300.0	-300	32.00 [1.26]	3363.0 [2253.2]	-300	32.0 [1.2]	3645.0 [2442.2]
400.0	-400	36.40 [1.43]	4396.0 [2945.3]	-400	36.0 [1.4]	4730.0 [3169.1]

Table 3. Nominal Diameters and Maximum Weights

Conductor Size (mm ²)	ZHPCG-15			ZHPCG-35		
	Part No.	Nom. OD in mm [in]	Max. Weight in kg/km [lb/1000 ft]	Part No.	Nom. OD in mm [in]	Max. Weight in kg/km [lb/1000 ft]
1	ZHPCG-15-1	3.77 [.14]	28.0 [18.1]	ZHPCG-35 -1	—	—
1.5	-1.5	3.79 [.15]	36.0 [24.2]	-1.5	4.55 [.18]	60.0 [40.3]
2.5	-2.5	4.27 [.17]	45.0 [30.2]	-2.5	5.07 [.20]	82.0 [55.1]
4.0	-4	4.64 [.18]	60.0 [40.3]	-4	5.66 [.22]	100.0 [67.2]
6.0	-6	5.31 [.21]	85.0 [57.1]	-6	6.15 [.24]	130.0 [87.4]
10.0	-10	6.53 [.26]	135.0 [90.7]	-10	7.33 [.29]	185.0 [124.3]
16.0	-16	8.03 [.32]	195.0 [131.0]	-16	8.83 [.35]	250.0 [167.9]
25.0	-25	9.70 [.38]	300.0 [201.6]	-25	10.50 [.41]	350.0 [235.2]
35.0	-35	11.30 [.44]	443.0 [297.7]	-35	11.70 [.46]	430.0 [288.9]
50.0	-50	13.50 [.53]	623.0 [418.6]	-50	13.48 [.53]	590.0 [396.5]
70.0	-70	15.60 [.61]	847.0 [569.1]	-70	15.33 [.60]	790.0 [530.8]
95.0	-95	18.10 [.71]	1119.0 [751.9]	-95	17.93 [.71]	1020.0 [685.4]
120.0	-120	19.80 [.78]	1445.0 [970.9]	-120	19.80 [.78]	1320.0 [887.0]
150.0	-150	22.00 [.87]	1775.0 [1192.7]	-150	21.44 [.84]	1550.0 [1041.5]
185.0	-185	24.40 [.96]	2115.0 [1421.2]	-184	23.28 [.92]	1900.0 [1276.7]
240.0	-240	27.80 [1.09]	2762.0 [1856.0]	-240	27.33 [1.08]	2500.0 [1679.9]
300.0	-300	31.20 [1.23]	3452.0 [2320.0]	-300	32.50 [1.28]	3562.0 [2393.5]
400.0	-400	35.20 [1.39]	4474.0 [3006.4]	-400	37.00 [1.46]	5645.0 [3793.3]

Part Numbering System

XXX XX - XX - X

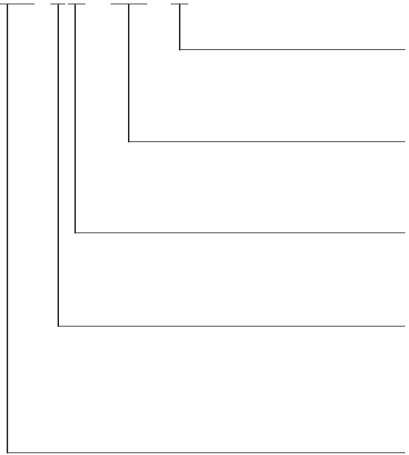
**Standard Colors**

0 = Black 8 = Gray

Conductor Cross Section(1.5 to 400 mm²)**Conductor Type**

5 = IEC Class 5 - Flexible 6 = IEC Class 6 - Very flexible

Voltage Rating1 = 600/1000 V
3 = 1900/3300 V**Insulating Type**TR
FTR
ZHI
AF

Conductor Sizes, Strandings, and Resistance Values

**Applications**

The conductors used with Raychem wires are concentric in construction and are specifically designed for use with thin-wall insulations. The table on the next page gives nominal values for tin-plated copper, silver-plated copper, and silver-plated high-strength copper alloy (SPHSCA) constructions. Typically, tin-plated copper is suitable for use in applications up to 150°C [302°F] and silver-plated copper in applications up to 200°C [392°F] (SPEC 55 wire only).

The current-carrying capacities assume a maximum 60°C [140°F] increase in temperature of a single wire in free air at 40°C [104°F]. For details of performance in conditions other than 40°C [104°F], contact Tyco Electronics.

Available in:

Americas	■
Europe	■
Asia Pacific	■

Nominal Values of American Wire Gauge (AWG) and Metric Conductors

AWG	Size	Stranding No./mm	Stranding No./AWG	Outside Diameter (min.-max.)		Max Resistance in Ω/km (Ω/1000 ft)			Current-Carrying Capacity (amps)
	mm ²					Tin-copper	Silver-copper	SPHSCA	
30	0.06	7/0.10	7/38	0.28-0.31	[0.011-0.012]	347 [106]	324 [99]	377 [115]	3.0
28	0.09	7/0.13	7/36	0.36-0.39	[0.014-0.015]	220 [67]	205 [62]	239 [73]	4.0
26	0.15	19/0.10	19/38	0.46-0.49	[0.018-0.019]	133 [40]	123 [37]	144 [44]	5.5
24	0.25	19/0.13	19/36	0.55-0.62	[0.022-0.024]	84 [26]	78 [24]	91 [28]	7.5
22	0.40	19/0.15	19/34	0.70-0.76	[0.028-0.030]	51 [16]	49 [15]	56 [17]	10.0
20	0.60	19/0.20	19/32	0.92-0.97	[0.036-0.038]	31 [9]	30 [9]	34 [10]	13.0
18	1.00	19/0.25	19/30	1.18-1.26	[0.046-0.050]	20 [6]	20 [6]	—	17.5
16	1.20	19/0.30	19/29	1.34-1.48	[0.053-0.058]	15 [4]	15 [4]	—	20.0
14	2.00	37/0.25	37/30	1.65-1.72	[0.065-0.068]	10 [3]	10 [3]	—	28.0
12	3.00	37/0.32	37/28	2.12-2.18	[0.083-0.086]	7 [2]	7 [2]	—	3705.0
10	4.50	37/0.40	37/26	2.69-2.74	[0.106-0.108]	4 [1]	4 [1]	—	53.0
8	9.00	133/0.29	133/29	4.01-4.20	[0.158-0.165]	2 [0.6]	2 [0.6]	—	78.0
6	13.5	133/0.36	133/27 [5.30]	5.03-5.48	[0.198-0.216]	1.4 [0.4]	1.4 [0.4]	—	105.0
4	21.0	133/0.45	133/25 [6.62]	6.35-6.96	[0.250-0.274]	0.9 [0.3]	0.9 [0.3]	—	142.0
2	33.0	665/0.25	665/30 [8.54]	8.13-8.64	[0.320-0.340]	0.6 [0.2]	0.6 [0.2]	—	196.0
0	51.0	1045/0.25	1045/30 [10.87]	10.00-10.80	[0.394-0.425]	0.4 [0.1]	0.4 [0.1]	—	266.0

Note: Abbreviations:

- Cond. = Conductor
- SPHSCA = Silver-plated high-strength copper
- Tin-copper = Tin-plated copper
- Silver-copper = Silver-plated copper
- N/A = Not available

For product details, please refer to relevant specification control drawing.

Current Derating Factors for Wire Bundles in Free Air

No. of wires	2	3	4	7	9	12	15	18	21	24	27	30	37
Derating factor	.825	.73	.66	.54	.49	.43	.39	.36	.33	.31	.29	.28	.26

High Performance Interconnection Fiber Optic Link

Product Facts

- Low smoke
- Low corrosive gas emission
- Limited fire hazard
- Halogen free
- Small size and lightweight
- Custom design
- Range of jacket materials
- Inherent security of transmitted signals
- Low loss, high performance cables
- Water-blocking options
- Meets the requirements of Def Stan 60-1 part 2

Typical applications

- Military communications
- Military control systems
- Naval applications
- Underwater and ROV's
- Hazardous Environments



Fiber Optic Cables

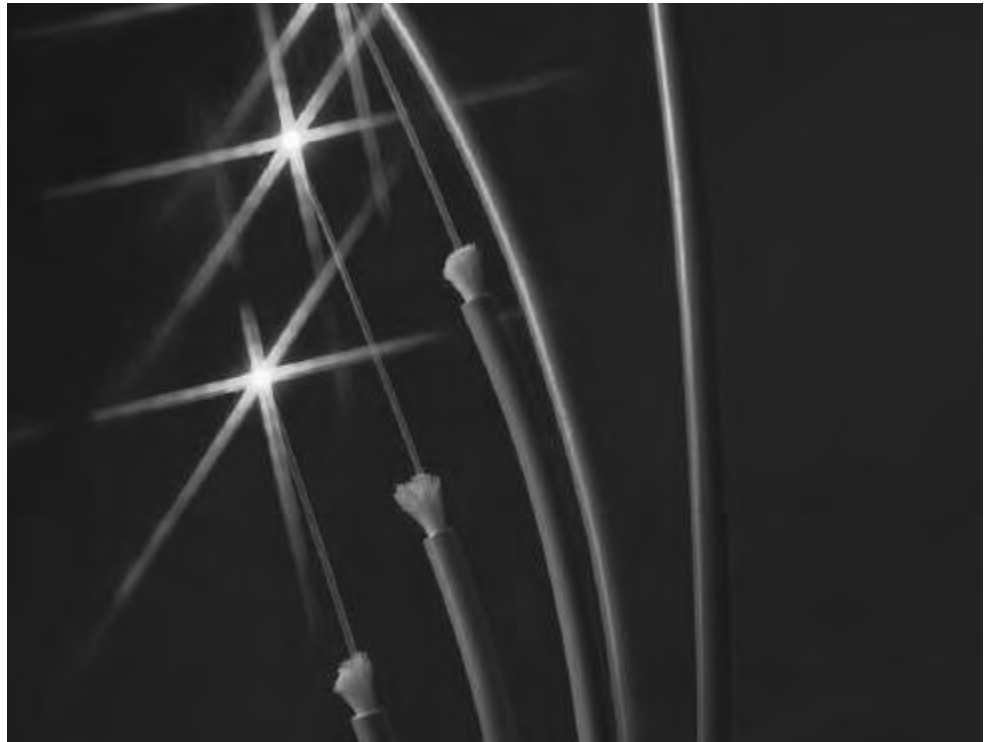

Standard Fiber Optic Cable Constructions

The use of increasingly sensitive and more sophisticated equipment in marine and military applications means a corresponding requirement for high performance interconnection links. Fiber optic links offer high performance and have many advantages over copper systems such as:

- Interference immunity (EMI & RFI).
- High bandwidth (for improved message capacity).
- Small size, lightweight.
- Low loss, durability.
- Security and safety.

However, to ensure the reliability of a fiber system the cable design, materials and interconnection accessories employed are all extremely important.

Tyco Electronics provides a range of single and multi-core Fiber Optic Cables offering innovative solutions to interconnect problems. Tyco Electronics leadership in the field of advanced material technology, coupled with more than 15 years experience of supplying ruggedized cables for marine and military applications, ensures superior performance levels in the harshest of environments.

Available in:

- Americas ■
- Europe ■
- Asia Pacific ■

Simplex Fiber Optic Cable

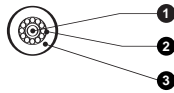

Component	Fiber Size	Qty/Diameter
1. Secondary Buffered Fiber	(62.5/125)	1
2. Strength Member	—	1.5 mm
3. Zerohal Sheath	—	2.7 ± 0.2 mm

Ruggedized Simplex Fiber Optic Cable

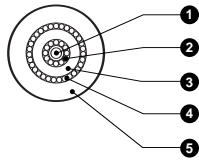

Component	Fiber size	Qty/Diameter
1. Secondary Buffered Fiber	(62.5/125)	1
2. Strength Member	—	1.5 mm
3. Zerohal Sheath	—	2.7 mm
4. Strength Member	—	3.3 mm
5. Zerohal Sheath	—	5.3 ± 0.2 mm

2 Channel Ruggedized Fiber Optic Cable

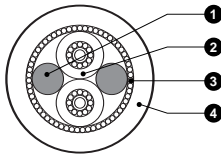

Component	Fiber size	Qty/Diameter
1. Strength Member	—	2
2. Simplex Cable	(62.5/125)	2
3. Strength Member	—	6.0 mm
4. Zerohal Sheath	—	8.2 ± 0.3 mm

4 Channel Ruggedized Fiber Optic Cable

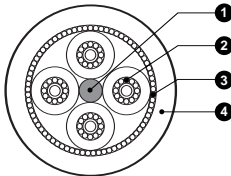

Component	Fiber size	Qty/Diameter
1. Strength Member	—	1
2. Simplex Cable	(62.5/125)	4 / 6.7 mm
3. Strength Member	—	7.3 mm
4. Zerohal Sheath	—	9.5 ± 0.5 mm

8 Channel Ruggedized Fiber Optic Cable

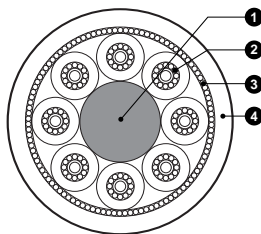

Component	Fiber size	Qty/Diameter
1. Strength Member	—	1
2. Simplex Cable	(62.5/125)	8 / 9.8 mm
3. Strength Member	—	10.4 mm
4. Zerohal Sheath	—	12.5 ± 0.5 mm

High Performance Interconnection Fiber Optic Link

Fiber Optic Cables (Continued)

Fiber Optic Equipment Cable

The diagram on the right shows a typical equipment cable, which can also be used as a sub-unit or simplex component for the larger multi-core cables, as shown in the diagrams on the previous page. The fiber used is a high performance tight buffer type comprising an all silica fiber, with multiple coatings designed to provide mechanical and environmental protection, micro-bend resistance, and ease of handling in the field. Most common fiber types are readily available (see table below) and more specialized fibers are available on request.

The equipment cable has a layer of served aramid yarn providing high flexibility and tensile strength, while the outer sheath provides environmental and mechanical protection, along with low smoke emission and chemical resistance.

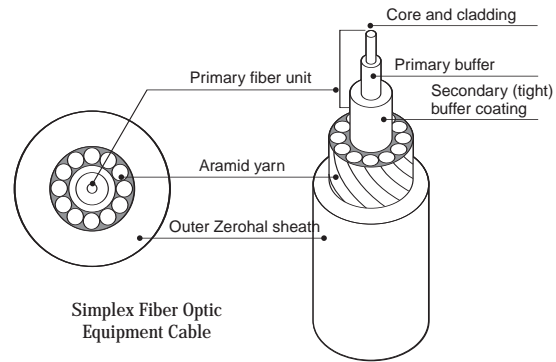

The materials and types of designs employed have been thoroughly tested to Def Stan 60-1 (see test data on the next page) and Def Stan 61-12 Part 31 which demonstrate the suitability of the cables and fibers for use in high performance and critical marine applications.

While offering a standard range of tight buffered multi and single mode fiber optic cables, Tyco Electronics also offers the option of custom design for specific applications. These cables capitalize on the small size of the fiber thereby enabling efficient, ergonomic and reliable interconnection.



Typical 2-Channel Cable

Fiber Types and Common Features

Type	Attenuation	Bandwidth	Dispersion Slope	Numerical Aperture
—	dB/km@850/1300/1550nm	MHz-km@850/1300nm	ps/(nm ² -km)	—
8/125	—/0.4/0.25	n/a	0.093	0.1
50/125	3.5/1.2/—	400/600	n/a	0.20
62.5/125	3.5/1.2/—	160/500	n/a	0.275
100/140	4.5/2.0/—	200/200	n/a	0.29

All fibers supplied with a high performance three layer tight buffer. Cables can be supplied with water-blocking and marking to suit customer requirement, and any combination of the fiber types listed above.

Table of Requirements and Results from Def Stan 60 – 1 Part 2

Definition	Requirements	Part 2		
Cable tensile strength	<0.5% cable elongation no increase in attenuation at full load and after test compared to pre-test value.	1000N applied at 100N/minute	Pass	
Cable bend	No cracking or deformation of cable sheath. <0.5dB change after test.	20N load, 10 cycles of wind and unwind. 6 wraps.	Pass	
Cold bend	No cracking or deformation of cable sheath. <0.5dB change after test.	20N load, 10 cycles of wind and unwind. 6 wraps, -30°C.	Pass	
Cyclic bend	No cracking or deformation of cable sheath. <0.5dB change after test.	40N, 1000 cycles.	Pass	
Cable impact	No cracking or deformation of cable sheath. <0.5dB change after test.	100 impacts. 12.5 mm radius, 1kg hammer, 100 mm height	Pass	
Cable crush	No cracking or deformation of cable sheath. <0.5dB change after test <20% reduction from original diameter.	2000N/5 min	Pass	
Cable snatch	No cracking or deformation of cable sheath. <0.5dB change after test <20% reduction from original diameter.	1kg, 10 cycles	Pass	
Dynamic cut through	≥ 25N	85°C, 60N/minute, 0.45mm diameter needle blade	Pass	
Tear resistance	5 N/mm	—	Pass	
Shrinkage	<3mm total	16 hrs at -30°C and 16 hrs at 85°C	Pass	
Scrape abrasion	500 cycles minimum	5N, 85°C, 0.45 mm diameter needle blade	Pass	
Fluids	Volume	25 TS ret 60 Eb ret 60	Diesel F76 28 days @ 20°C	Pass
	swell	15 min % 60 min % 60	OX-30 28 days @ 50°C	Pass
	max %	15 60 60	OX-40 HS200X 28 days @ 50°C	Pass
		10 60 60	OMD-113 28 days @ 50°C	Pass
		50 50 50	OX-28 28 days @ 50°C	Pass
		10 80 80	Deionized water 28 days @ 50°C	Pass
	10 80 80	Deionized water + 3.5% NaCl 28 days @ 50°C	Pass	
Accelerated ageing	<20% change in TS/Eb/tear between 14 and 28 days. Eb ≥ 150%	110°C for 14 and 28 days.	Pass	
Arrhenius plot	40,000 hours at 85°C	End point measurement: 50% absolute elongation	Pass	
Stability	175% max. elongation, 25% max. permanent elongation.	105°C, 0.2N/mm ² stress.	Pass	
Pressure	Indentation not to exceed 50%.	85°C for 4 hrs.	Pass	
Ozone	No cracks with normal vision.	80 – 100ppm for 120 hrs	Pass	
UV light resistance	≤ 80% Eb change, ≤ 20% TS change.	8 hrs UV 55°C, 4 hrs humidity 40°C, (UV-B) 1000 hrs.	Pass	
Smoke Index	20 maximum	NES 711	Pass	
Toxicity index	5 maximum	NES 713	Pass	
Halogen index	No detectable halogens.	Sodium fusion test (Lassaigne)	Pass	
Oxygen index	29 minimum	BS 2782 Part 1 Method 141D	Pass	
Temperature index	250°C minimum	Nes 715	Pass	
Flammability	Not to reach within 50 mm of the lower clamp.	BS 4066 Part 1	Pass	

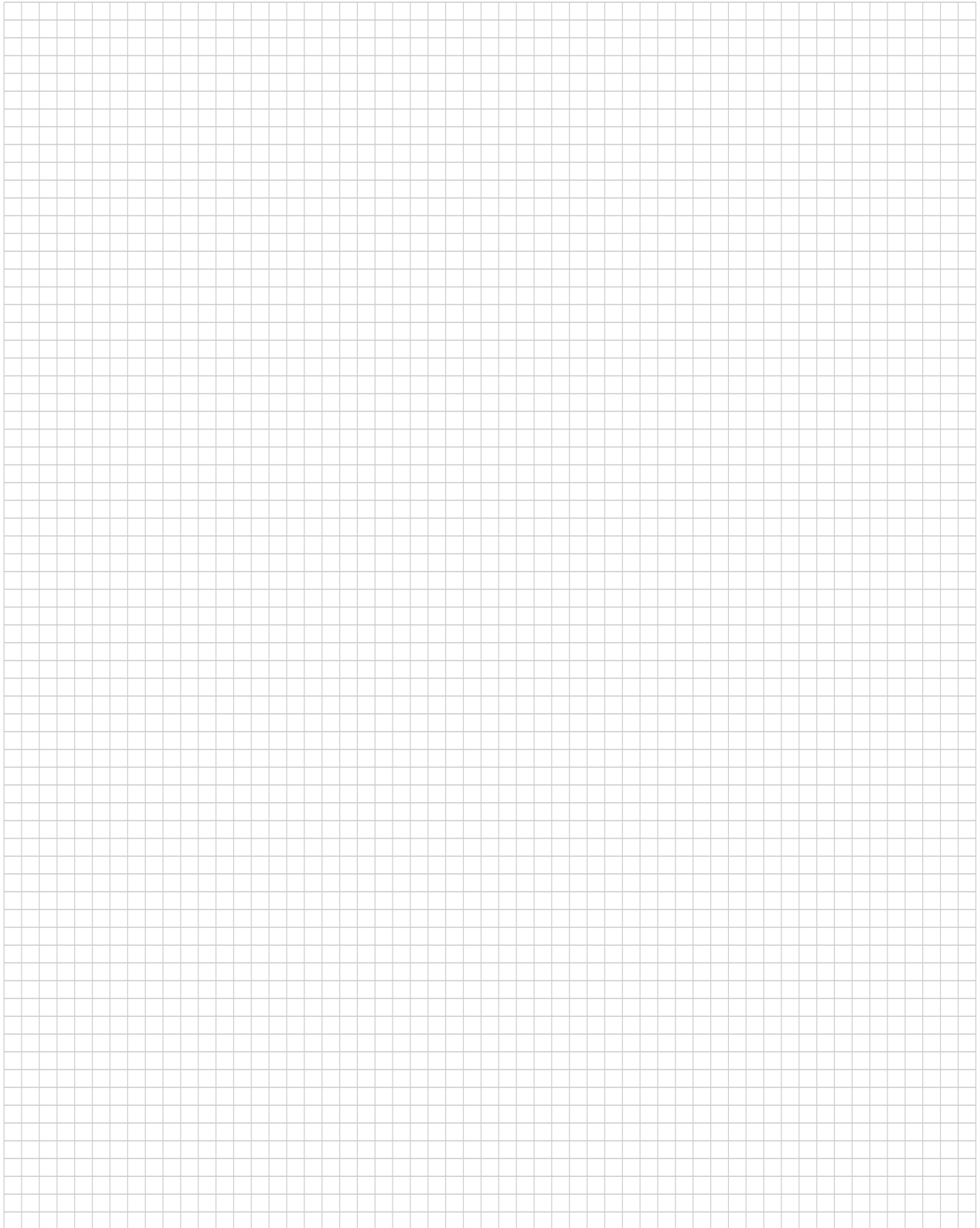

Raychem application equipment is designed and engineered specifically for installation of Raychem heat-shrinkable products. These tools provide the optimal heating temperatures, performance, and control features for maximum production efficiency.

Table of Contents

AA-400 Super Heater	
Compressed-air heating tool	10-2
AD-1319-9	
Holding fixture tool	10-3
AD-1377, AD-1522	
Hand-operated crimp tools	10-4
AD-3050-SEAL-TEST-EQUIP	
Seal test equipment Splice sealing and connector sealing evaluation	
- various products	10-5
AD-5000 and RH-396X	
Tinel-Lock installation tool Tinel-Lock screened termination products	10-7
AD-5010-Tinel-Bench-230V	
Tinel-Lock installation tool Tinel-Lock screened termination products	10-9
CV-1981, CV-1983	
Heavy-duty hot-air heating tools	10-11
HL1802E/HL2005E	
Steinel® general purpose hot-air heating tool	10-13
IR-1891	
Shuttle machine - twin workstation heater for multiple installation of	
short length tubing products	10-15
IR-550 Mark II	
Infrared heating tool	10-17
IR-1759 MiniRay	
Infrared heating tool	10-18
Model 16B	
Belt heater	10-19
Model 19	
Conveyor heater for processing Raychem heat-shrinkable tubing	
and terminating devices	10-21
Model 81CE	
Discrete heater	10-23
Model 105	
Tunnel oven	10-25
RBK-ILS-Processor MkII	
Installation of splice sealing products adjacent to ultrasonic welder	10-27
ThermoGun HG	
Hot-air heating tool	10-29

Note: Users should independently evaluate the suitability of the product for their application. Before ordering, check with Tyco Electronics for most current data.

AA-400 Super Heater Compressed-Air Heating Tool

Product Facts

- Automatic power cut-off switch to protect heating element if air flow is interrupted
- Pressure regulator and gauge for adjusting air flow and temperature
- Indicator light that goes on when power is applied to heating element
- Very focused heat
- Wide variety of reflectors available
- Excellent tool for small items and confined areas

Applications

Used for installing heat-shrinkable tubing in multiple applications. Excellent for installing SolderSleeve devices (wire-to-pin applications) and SolderTacts contacts.



Specifications

Utility Requirements	
Electrical	120-V model: 120 Vac, 4 A, 50-60 Hz 240-V model: 240 Vac, 2 A, 50-60 Hz
Air (oil free)	60 psig minimum, 5 cfm

Ordering Information

Model	Voltage	Description	Part No.
AA-400 Super Heater with stand, needlepoint tip, Mini SolderSleeve reflector, and input air filter	120 Vac	AA-400-32-Mk3 (110V)	582602-000
	240 Vac (CE version)	AA-400-200-CE-SUPERHTR	281917-000
Accessories and Replacement Parts*	Part No.	Description	NSN Stock No.
SolderSleeve reflector	979646-000	AA-400-94-SLD-SLV-TIP-KIT	4940-00-609-4993
Needlepoint tip	979647-000	AA-400-96	4940-00-148-9847
Boot and tubing tip	979691-000	AA-400-101	4940-00-148-9848
Mini SolderSleeve reflector	979663-000	AA-400-102	4940-01-043-7634
Low-flow tip	979672-000	AA-400-103	3439-01-173-8810
Heating Element replacement kit, 120 V	013750-000	AA-400-128	—
Heating Element replacement kit, 240 V (CE)	444179-000	AA-400-228-EL-KT-240V-CE	—
Stand	979649-000	AA-400-09	—
Input air filter	979673-000	AA-400-P-Y-92-Filter	—
Air hose replacement kit	156553-000	AA-400-136	—
Gun and air hose replacement kit	238231-000	AA-400-229-Gun-Hse-Kit	—

*Controller is not sold separately.

Available in:	Americas	Europe	Asia Pacific
	■	■	■

Holding Fixture Tool AD-1319-9

Product Facts

- AD-1319-9 comes with two lateral wire clamps as standard
- Secures wire or cable, enabling easy installation of products

Applications

Simplifies and speeds installation of Raychem SolderSleeve terminators or splices and SolderTacts shielded contacts.



Specifications and Dimensions

Dimensions	18 cm [7.07 in] W x 15 cm [5.91 in] L
Weight	300 g [.67 lb]

Product Range Covered	
SolderSleeve splices	MiniSeal, CWT-9XXX, D-1744, D-110
Shield terminators	D-100-XX
SolderTacts contacts	D-602-XX

Ordering Information

Model	Description	Part No.
Holding fixture	AD-1319-9	993850-000
38999 size 8 SolderTacts adapter	AT-1319-22	395241-000
38999 size 16 SolderTacts adapter	AT-1319-78	413186-000
Submin SolderTacts adapter	AT-1319-12	993872-000
748 SolderTacts adapter	AT-1319-14	993877-000
723 SolderTacts adapter	AT-1319-19	993938-000
482 size 16 SolderTacts adapter	AT-1319-17	993917-000

Note: Additional tooling for SolderTacts can be found under SolderTacts contacts, see section 8.

Available in:	Americas	Europe	Asia Pacific
	■	■	■

Hand-Operated Crimp Tools AD-1377, AD-1522

AD-1377, AD-1522



AD-1377 Crimp Tool

The Raychem AD-1377 crimp tool fits all MiniSeal crimp barrels. It also meets MIL specification M22520/37-01. A calibration verification gauge, AD-1386, is also available for the AD-1377. The gauge meets MIL specification M22520/39-01

AD-1522 Crimp Tool

The Raychem AD-1522 crimp tool crimps all DuraSeal crimp and PolyCrimp products. It has a preset crimp depth that provides the optimum combination of tensile strength and insulation integrity in the finished splice.

Ordering Information

Model	Description	Part No.
AD-1377 MiniSeal crimp tool	AD-1377-CRIMP-TOOL	992008-000
AD-1386 Calibration gauge	AD-1386-CALIBRATION-GAUGE	992013-000
AD-1522 DuraSeal crimp tool	AD-1522-1-CRIMPING TOOL	047011-000

Available in:	Americas	Europe	Asia Pacific
	■	■	■

Seal Test Equipment Splice Sealing and Connector Sealing Evaluation – Various Products

Product Facts

- Simple fixture design allows fast sealing test result assisting determination of installation conditions for splice sealing products
- Connector fixture adapter allows connector sealing verification
- Strong portable container allows use in various locations



Applications

The AD-3050-SEAL-TEST-EQ-NC is a manually operated pneumatic device, intended for use as a convenient 'in-process' sampling technique for checking sealed splices. Different combinations of in-line or stub splices can be pressure tested in any of the combination of fixtures (8 in total). There is also a facility to allow leak testing of various connectors.

Tyco Electronics UK has seen good correlation between results obtained with the AD-3050 and those obtained through water immersion testing. However testing in accordance with the OEM specification is the only guaranteed way of confirming that the OEM spec is being met. The splice products are located

in clamps which deliver the test pressure. The product is immersed in water and pressure is delivered down the wire(s) to the sealed area. The test result is determined visually by looking for bubbles in the area of the sealing product.

Use of this equipment is described in Tyco Electronics UK procedure, reference No. PIP/017/95. This equipment can also check for poke through i.e. where individual wire strands poke through the installed heat-shrinkable sleeve by using the AD-3050-SEAL-POKE-IND. Poke through is eliminated by ensuring correct welding and subsequent handling conditions.

Available in:	Americas	Europe	Asia Pacific
	■	■	■

Electronics

AD-3050-SEAL-TEST-EQUIP (Continued)

Seal Test Equipment Splice
Sealing and Connector
Sealing Evaluation –
Various Products
(Continued)

Technical Specification

Pneumatic Supply	6 bar maximum, filtered supply. 2 bar test pressure maximum. (Test pressure typically 0.5 bar)
Machine Cycle Times for seal testing:	Typically 1 minute
Total System Noise:	Negligible noise from air test
Dimensions:	550 x 350 x 215 [22 x 14 x 8 in] (Excludes packing case)
Weight:	4 Kg (8.80 lb) (Excludes packing case)
	9.6 Kg (21.20 lb) (Includes packing case)

Ordering Information

	Description	Part No.
Seal Test Equipment	AD-3050-SEAL-TEST-EQ-NC	C82893-000

Accessories

	Description	Part No.
Tool Case	AD-3050-SEAL-TEST-CASE-ONLY	F66989-000
Splice Poke-through Indicator	AD-3050-SEAL-POKE-IND	E63259-000

Recommended Spares

	Description	Part No.
Set of 8 Seals**	AD-3050-SEAL-8-KIT	299155-000
Clamp assembly including seals	AD-3050-SEAL-CLAMP-ASSY	168927-000
Sealing tape	EPDM foam, 6 mm x 9 mm, with acrylic adhesive backing.	—

** Full set of seals

AD-5000 and RH-396X Tinel-Lock Installation Tool
Tinel-Lock Screened Termination Products

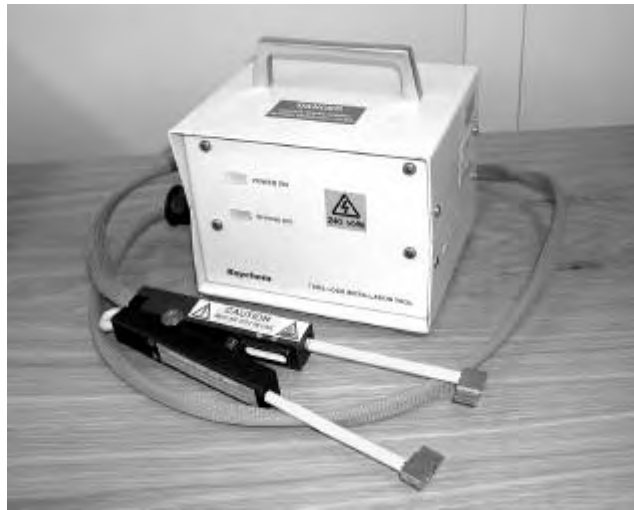

Applications

The AD-5000-TINEL-ASSY is a manually operated resistance heating tool designed specifically to install Raychem Tinel-Lock ring screened terminations in small batches. Recommended maximum continuous batch is 15, 6 second installations. The standard tool accommodates Tinel Rings from size TR04 to TR24 inclusive.

Various electrode (jaws) types can be used to install other Tinel-Lock ring sizes and types. The operator uses the hand-held tool to install the Tinel-Lock ring in its correct position on screened terminations. The Tinel-Lock ring has two patches of thermochromic paint on the Tinel-Lock ring.

The operator positions the Tinel-Lock ring on the terminations, with at least one of the patches of thermochromic paint visible. The Tinel-Lock ring is then clamped in the jaws to start the installation. Installation is complete when the thermochromic paint turns black.

AD-5000 available in:	Americas	Europe	Asia Pacific
	■	■	■
RH-396X available in:	Americas	Europe	Asia Pacific
	■		■

**AD-5000 and RH-396X Tinel-Lock Installation Tool
Tinel-Lock Screened Termination Products (Continued)**

Technical Specification

Electrical Supply	220V-240V-50Hz
Machine Cycle Times for Tinel-Lock rings used on typical range of harnesses:	5 to 15 Seconds depending on ring size and braid type on the termination.
Mains Fuse	240 V 2 Amp (Type T anti - surge)
Total System Noise	Silent Operation
Dimensions	340 x 320 x 170 mm [13.4 x 13 x 6.7 in]
Weight	4.2 Kg

Product Range

	Tinel-Lock Rings
STANDARD ELECTRODES FITTED :	Sizes TR04 to TR24
Conduit Electrodes Fitted	Conduit systems / TR rings on double braid
Square Profile Electrodes Fitted	TC02-TC03 RINGS

Ordering Information

	Description	Part No.
Tinel installation tool (220V-240V)	AD-5000-TINEL-ASSY	411993-000
Also available in the US and Asia Pacific: Resistance heating tool: 915088-01. Use with American Beauty Transformer - #105-A12 (110V) or #105-A12-220V (220V) and foot switch #10519		
Tinel installation tool (120 VAC)	RH-3960-1-TINEL-KIT-120V	173643-000
Tinel installation tool (220 VAC)	RH-3965-1-TINEL-KIT-220V	859855-000

Recommended Spares —
AD-5000

Hand Tool Assembly	AD-5000-TINEL-HAND-TOOL	795257-000
Standard Electrodes (TR04 to TR24 RINGS)	AD-5000-TINEL-STD-ELECT	180245-000
Conduit Electrodes (Conduit systems or TR rings on double braid)	AD-5000-TINEL-COND-ELECT	747235-000
Square Profile Electrodes (TC02-TC03 RINGS)	AD-5000-TINEL-SQ-EXT-ELEC	065583-000

Recommended Spares —
RH-396X

Hand Tool Assembly	915088-01-TINI-RING-HEATR	170224-000
Foot Switch	IR-500-P-FOOT-SWITCH	993702-000
120 VAC Transformer	TRNSFMR-120V-105-A12-250W	570939-000
220 VAC Transformer	TRNSFMR-220V-105-A12-250W	574557-000

N.B. Electrodes are two per P.C.N.

AD-5010-Tinel Bench-230V Tinel-Lock Installation Tool
Tinel-Lock Screened Termination Products



Applications

The AD-5010-TINEL-BENCH-230V is a manually operated resistance heating tool designed specifically to install Raychem Tinel-Lock ring screened terminations in large batches, in continuous operation. The tool accommodates Tinel Rings from size TR04 to TR24 inclusive. Various electrode (jaws) types can be used to install other Tinel-Lock ring sizes and types.

The operator uses the tool to install the Tinel-Lock ring in its correct position on screened terminations. The Tinel-Lock ring has two patches of thermochromic paint to ensure consistent installation.

The operator positions the Tinel-Lock ring on the termination, with at least one of the patches of thermochromic paint visible, and operates the push-button (or footswitch if fitted).

The Tinel-Lock ring is then located in spring-loaded jaws (it is not necessary to clamp the ring manually). The push button or footswitch (if fitted) is then operated to start the cycle, the cable is held in position for the duration of the installation. This is complete when the thermochromic paint turns black. This normally takes between 3 to 12 seconds, depending on ring size, braid type etc. An

ammeter on the front panel shows installation current used. A needle file is provided for periodic cleaning of the electrodes.

Available in:	Americas	Europe	Asia Pacific
	■	■	■

Electronics

AD-5010-Tinel Bench-230V Tinel-Lock Installation Tool
Tinel-Lock Screened Termination Products (Continued)

Technical Specification

Electrical Supply	230 V 50 Hz
Machine Cycle Times for Tinel-Lock rings used on typical range of harnesses:	3 to 12 Seconds depending on ring size and braid type on the termination.
Mains Fuses (2)	240 V 2 Amp (Type T anti - surge)
Total System Noise	Silent Operation
Dimensions	245 x 305 x 290 mm [10 x 12 x 11 in]
Weight	24 Kg

Product Range

	Tinel-Lock rings
STANDARD ELECTRODES FITTED :	Sizes TR04 to TR24, conduit systems and TR rings on double braid
Square Profile Electrodes Fitted	TC02-TC03 RINGS

Accessories

	Description	Part No.
Footswitch Kit	AD-5010-BENCH-FOOTSW-KIT	072845-000

Recommended Spares

	Description	Part No.
Standard Electrodes (TR04-TR24 RINGS)	AD-5010-BENCH-STD-ELECT	222899-000
Square Profile Electrodes (TC02-TC03 RINGS)	AD-5010-BENCH-SQ-ELECT	727799-000
Mechanism Assembly (Including electrode set)	AD-5010-BENCH-MECH	924079-000

N.B Electrodes are two per P.C.N.

Ordering Information

	Description	Part No.
Tinel installation tool	AD-5000-TINEL-ASSY	411993-000

CV-1981 and CV-1983 Heavy-Duty Hot-Air Heating Tools

Product Facts

- Robust, double-insulated, heavy-duty unit
- Highest-wattage unit (1600–2260 watts)
- Integral stand that allows use as bench tool
- Safe, quiet operation
- Precisely variable temperature
- Variety of reflectors available
- Easy fixturing for dual opposing heating

Applications

Used for installing dual wall or single wall tubing up to three inches in diameter and for installing Solder Sleeve devices. Closed loop version (PID) also available.



Technical Specification

Electrical Supply	
CV-1981-MK2	120 V and 230 V
CV-1983	120 V and 230 V
CV-1981 PID	120 V and 230 V
Power Consumption	
CV-1981-MK2	1600 W
CV-1983	2260 W/3060 W
CV-1981 PID	1600 W
Total System Noise	
CV-1981-MK2	65dB
CV-1983	65dB
CV-1981 PID	>70dB
Length	
CV-1981-MK2	340 [13]
CV-1983	320 [13]
CV-1981 PID	350 [13]
Weight	
CV-1981-MK2	1.3 Kg [2.90 lb]
CV-1983	1.5 Kg [3.30 lb]
CV-1981 PID	1.4 Kg [3.10 lb]
Air Flow	
CV-1981-MK2	Max 230 l/min
CV-1983	Max 500 l/min
CV-1981 PID	230 l/min

Product Range

All dual wall, single wall and molded part products.
 Various devices products.
 For other Raychem products , contact Tyco Electronics.

Available in:	Americas	Europe	Asia Pacific
	■	■	■

Ordering Information

CV-1981 and CV-1983 Heavy-Duty Hot-Air Heating Tools (Continued)

Equipment	Description	Part No.	Voltage	Hz
CV-1981-MK2	CV-1981-120V1600W-CANMK2	A42716-000	120V	50/60 Hz
	CV-1981-120V1600W-UKMK2	E95798-000	120V	50/60 Hz
	CV-1981-230V1600WMMK2	813914-000	230V	50/60 Hz
	CV-1981-230V1600W-SEVMK2	F25836-000	230V	50/60 Hz
	CV-1981-230V1600-UKMK2	340970-000	230V	50/60 Hz
CV-1983	CV-1983-110V-2260W-UK	441753-000	120V	50/60 Hz
	CV-1983-220V-2260W	773898-000	230V	50/60 Hz
	CV-1983-220V-2260W-UK	985426-000	230V	50/60 Hz
	CV-1983-220V-3060W	538361-000	230V	50/60 Hz
	CV-1983-220V-3060W-UK	231866-000	230V	50/60 Hz
CV-1981-PID	CV-1981-120V-1600W-CANPIDF	839218-000	120V	50/60 Hz
	CV-1981-120V-1600W-UKPID	928826-000	120V	50/60 Hz
	CV-1981-230V-1600WPID	958770-000	230V	50/60 Hz
	CV-1981-230V-1600W-SEVPIDF	434366-000	230V	50/60 Hz
	CV-1981-230V-1600W-UKPIDF	385828-000	230V	50/60 Hz
CV-1983 Barrel Adapter	AD-1962	989172-000	—	—

Accessories

	Application	Part No.
PR-12 reflector	Tubing: 6.3–25.4 mm [0.25–1 in]	991973-000
PR-13 reflector	Tubing: Up to 6 mm [0.25 in]	991963-000
PR-13C reflector	Large SolderSleeve products	991974-000
PR-21 reflector	Tubing: Up to 25.4 mm [1 in]	991984-000
PR-24 reflector	Tubing/molded parts: 25.4–34.93 mm [1–1.38 in]	991964-000
PR-24A reflector	Tubing/molded parts: 34.93–60.33 mm [1.38–2.38 in]	991989-000
PR-25 reflector	SolderSleeve products: Up to 7 mm [0.28 in]	991965-000
PR-25D reflector	SolderSleeve products: 6.3–12.7 mm [0.25–0.50 in]	989523-000
PR-26 reflector	Small SolderSleeve products	991967-000
PR-33 reflector	SolderSleeve products: 19.05–25.4 mm [0.75–1 in]	997768-000
AD-1962 adapter for larger-barrel CV-1983	—	989172-000
PR-34 reflector	SolderSleeve products: 12.0–20.0 mm [0.47–0.79 in]	989111-000
PR-51	Special narrow reflector for molded part transitions (21.5 x 3.5 mm nozzle) [.85 x .14 in]	113069-000

*Note: A42716 supersedes and replaces 538005
340970 supersedes and replaces 923002

HL1802E and HL2005E Steinel® General Purpose Hot-Air Heating Tool

Products Facts

- Light weight
- Easy, quiet operation
- Precise variable temperature
- 1500 watts
- Reflectors and stand (optional)
- Wide variety of applications
- CE approved (230 V only)

Applications

Used for installing heat-shrinkable tubings and molded parts, SolderSleeve devices, and SolderTacts contacts.



Specifications

Steinel® (120 V) power requirement	120 V, 60 Hz, 12.5 A
Steinel® (230 V) power requirement	230 V, 50 Hz, 8.7 A
Rated heater element power	110V - 1500 W/230V-2000W
Weight	850 g [1.9 lb]
Cord length	Approx. 3 m [approx. 8 ft]
Typical temperature output*	49°C to 593°C [120°F to 1100°F]

*The Steinel® heating tool is equipped with a variable temperature control. The correct temperature setting of the tool will vary, depending on application characteristics. The recommended procedure is to experiment with scrap materials and start with the lowest temperature range.

Available in:	Americas	Europe	Asia Pacific
	■	■	■

Ordering Information

HL1802E and HL2005E Steinel® General Purpose Hot-Air Heating Tool (Continued)

Model /Description	Part No.
HL1802E-Kit-120 V**	289759-000
HL2005E-230V-Euro	910424-000
HL2005E-230V-UK	629014-000
HL2005E-Kit-230-Euro**	849224-000

Accessories and Replacement Parts	Description	Part No.
SolderSleeve reflector	HL1802E-074616	832011-000
HL1802E-ADAPT for use with PR reflectors***	HL1802E-ADAPT-PR	444817-000
Tubing reflector	HL1802E-070519	022611-000
Bench stand	HL1802E-BENCH-STD	717083-000
9-mm-diameter reduction nozzle	HL1802E-070618	930321-000

**Complete with SolderSleeve reflector.

***Selection of PR reflectors can be found in CV-1981/CV-1983 section.

Accessories



Clip-on bench stand (P/N 717083-000) for heating tool. Must be ordered separately.



SolderSleeve reflector (P/N 832011-000) for SolderSleeve terminators, SolderTacts contacts, and small-diameter tubing. Comes standard with Steinel® heating tool.

Optional tubing reflector (P/N 022611-000) for larger tubing and molded parts. Must be ordered separately.

IR-1891 Shuttle Machine — Twin Workstation Heater for Multiple Installation of Short Length Tubing Products

Product Facts

- Automatic cycle start once heater is manually positioned over product, which gives improved process control (recommended for adhesive lined heat-shrinkable tubing e.g. sealing applications)
- Automatic heating head retraction at end of cycle prevents damage to components
- Multiple product fixture assemblies give increased process rates
- Cooling fan above each fixture assembly maintains holding fixture at an acceptable temperature

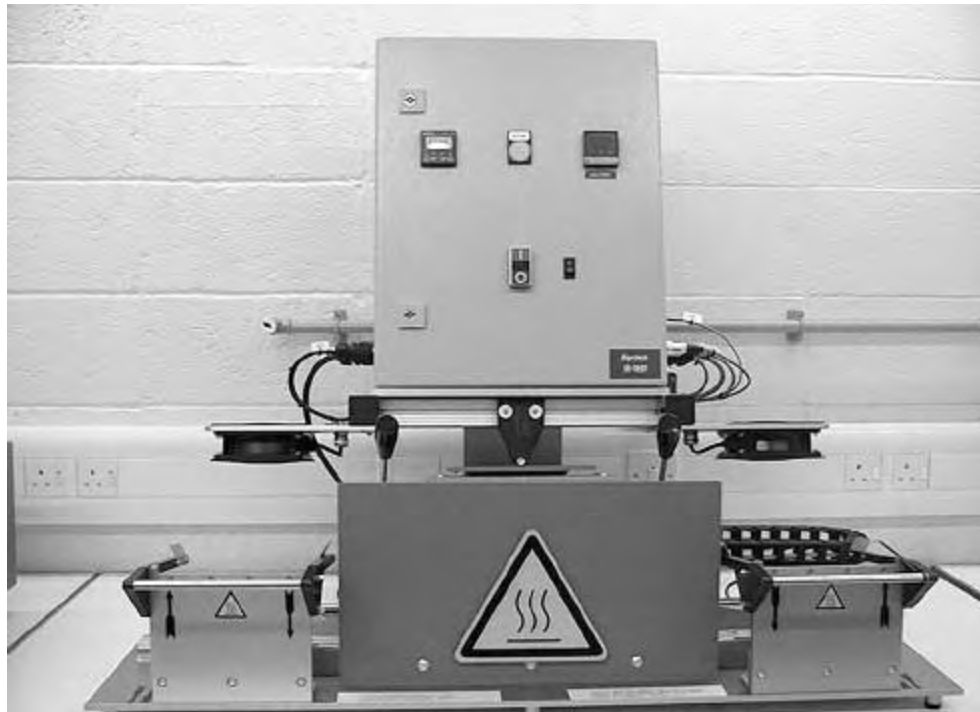

Applications

The IR-1891 is suitable for the installation of a range of Raychem heat-shrinkable tubing products onto a variety of small components, e.g. ring terminals, FASTON terminals and small connectors etc. The machine is provided with two work stations and a moveable heating head.

Each workstation is provided with supports for tooling fixtures (which must be specified and ordered separately). These support the workpieces and locate the tubing products. The operator loads the workpieces into the fixtures at one of the workstations, ensures that the tubing product is correctly positioned and then slides the heat head into position before initiating the heating cycle. The operator

then continues with loading/unloading the other workstation whilst the heating cycle is taking place.

The IR-1891-220V-Shuttle-Retrn is provided with closed loop temperature control and in addition the heat head is 'locked' into position by use of an electromagnet during the heating cycle.

Once the other workstation has been loaded and the first installation is complete, the heat head is moved into position over the product and the next heating cycle initiated. Heating times vary typically from 3 to 30 seconds depending on the size and type of tubing product. Process rates up to 1200 pieces/hour can be achieved depending on the heating time and the time

taken by the operator to load/unload the workpieces. The installation temperature/power can be varied according to product type/size and required cycle times.

The heating elements, which are continuously energized, are of the infra-red medium wave length type and consist of a coiled resistance wire contained in quartz glass tubes. The closed loop temperature control uses similar elements but having integral thermocouple sensors.

Available in:	Americas	Europe	Asia Pacific
		■	

IR-1891 Shuttle Machine — Twin Workstation Heater for Multiple Installation of Short Length Tubing Products (Continued)

Technical Specification

Electrical Supply	230 V Single Phase
Power Consumption	1600 W
Operating Temperature	650°C max
Process Rate	1200 / hour maximum depending on application and operator
Heating Times	3 to 20 seconds depending on application
System Noise	< 70 dB
Dimensions – 508636-000	L1100 x H650 x D500 mm [L43 x H25 x D20 in]
Dimensions – 613148-000 / 167309-000 / 289588-000	L1100 x H900 x D500 mm [L43 x H35 x D20 in]
Base Plate Dimensions 289588-000 / 167309-000	L1040 x D450 mm [L41 x D18 in]
Base Plate Dimensions 613148-000	L1040 x D397 mm [L41 x D16 in]

Product Range

Wide range of Raychem tubing products in particular LSTT, RNF-3000, RNF-100, HTAT, ATUM.
Maximum diameter 20 mm [0.8 in] and maximum length 60 mm [2.0 in]

Ordering Information

Description	Part No.
*IR-1891-220VShuttle-Retrn	289588-000
*IR-1891-220V-Retrn-Syl	613148-000

*Note: The descriptions given here DO NOT include the supply of the necessary tooling fixtures. These are designed for each individual application.

Accessories

Description	Part No.
Grippers:	
IR-1891-SI-GRP-165-RD-1mm Red Gripper with 1mm hole	629602-000
IR-1891-SI-GRP-165-CL-2mm Clear Gripper with 2mm hole	112676-000
IR-1891-SI-GRP-165-BK-3mm Black Gripper with 3mm hole	F83221-000
IR-1891-SI-GRP-165-WT-6mm White Gripper with 6mm hole	554196-000
Fixtures:	
IR-1891-Quick-Rel-ESS-6/1 ESS Cap (6/1) Fixture	096735-000
IR-1891-Quick-Rel-ESS-8/2 ESS Cap (8/2) Fixture	148597-000
IR-1891-Tool-Fixt-Bas-ESS Base Unit for Fixtures	760221-000

Note: A wider range of tooling fixtures and grippers designed for previous applications are available. Please contact Tyco Electronics for details.

Infrared Heating Tool IR-550 Mark II

Product Facts

- Lightweight, portable unit with pedestal base for benchtop operation
- Foot switch, so both hands can be free to hold parts
- Commercially available tungsten-halogen lamp
- Fan-cooled housing
- Instant on/off heat
- Viewing window that allows parts to be inspected during installation
- Quiet, focused IR operation

Applications

Used for installing small and large Solder Sleeve devices and SolderTacts contacts.



Specifications

Input power	105–120 V, 50–60 Hz, 4.5 A
Normal lamp life	More than 1000 hours of intermittent use
Weight	Approximately 2.5 Kg [5.5 lb]
Duty cycle	80%, 90-second max. heating times

Ordering Information

Model	Description	Part No.
IR-550 heating tool* (120 V) with RG-2 reflector, viewing window, and foot switch	IR-550-50-MARKII-HT-TOOL	994350-000

Note: For 230V CE-approved version, contact Tyco Electronics

Accessories and Replacement Parts

IR-550 foot switch (included with tool assembly 994350)	IR-550-216	994375-000
RG-6 reflector for large-diameter Solder Sleeve terminations; aperture is 25.4 mm [1.0 in] wide	IR-550-19	994590-000
RG-11 reflector; aperture is 12.7 mm [.5 in] wide	IR-550-41	993695-000
RG-9 reflector; aperture is 9.525 mm [.375 in] wide	IR-550-39	993693-000
RG-2 reflector, included with 994350; aperture is 19.05 mm [.75 in] wide	IR-550-24	993770-000
Lamp (120 V)	IR-1000-P-N-13	993020-000
Optical filter	IR-550-237	118902-000
Viewing window (frame not included)	IR-550-238	007510-000
IR-550 upgrade kit: filter, viewing window, inner reflector, outer reflector	IR-550-240-Refurb	529600-000

Available in:	Americas	Europe	Asia Pacific
	■		■

Electronics

IR-1759 MiniRay Infrared Heating Tool

Product Facts

- Small, lightweight, fan-cooled unit
- Small profile for installation where space is restricted
- Handheld operation
- Focused heat
- Quiet, efficient IR operation
- CE approved

Applications

Used for installing SolderSleeve devices and SolderTacts contacts.



* Control box not shown

Specifications and Dimensions

Lamp	Tungsten-halogen Nominal power 250 W, 24 Vac, 50–60 Hz
Fan	12 Vac (supplied through control unit)
Weight	.73 kg [1.6 lb]
Cable length	2 m [6.5 ft]
Electronic Control Unit	
Main supply	110/230 Vac, 50/60 Hz, 11 A/5.5A universal
Weight	3.4 kg [7.6 lb]
Dimensions	16.3 x 12.2 x 12.2 cm [6.4 x 4.8 x 4.8 in]

Ordering Information

	Description	Part No.
Complete kit consisting of: Handtool/Reflector/Control Box (Manual control, Dual voltage)	IR1759-MK3-AT3130-EDCont	898738-000

Accessories and Replacement Parts

Handtool, standard aperture	IR-1759-MK3/A	986899-000
Handtool, large aperture	IR-3104-MK3/A	035343-000
Control box with time control-230 V	ED-7-001-MK2-230V-50HZ	869233-000
Control box with time control-110 V	ED-7-002-MK2-110V-60HZ	903553-000
Control box with manual control-110/230V	ED-7-CONT-230/110V	684886-000
Battery powered control box	ED-7-Batterybox-230/110V	448969-000
Conversion kit (AE-897) for adapting standard-aperture MiniRay heating tool to wide-aperture MiniRay tool (includes reflector)	AT-313/AE-897	934630-000
Inner reflector (standard aperture)	AE-424	547918-000
Inner reflector (wide aperture)	AE-153	988285-000
Lamp (250 W, 24 V)	NAE-143-3	988208-000
Filter (standard aperture)	AES-IR1759-100-FILTER-DUL	431468-000
Filter (large aperture)	AES-IR1759-300-FLTR-LRG	F52511-000

*IR tools are not recommended for use with black wire or cable insulations.

Available in:	Americas	Europe	Asia Pacific
	■	■	■

Model 16B Belt Heater

Product Facts

- Controlled heating for installation of Raychem heat-shrinkable tubing at rates required for mass production
- Controlled repeatable heating: time and temperature settings can be fixed to maintain repeatable installation parameters
- Part positioning that is clearly defined and easy to maintain
- Operation that requires only minimal skill
- Efficient and economical operation, which greatly reduces labor costs. In most cases the throughput rate is limited only by the rate at which an operator can load parts into the heater

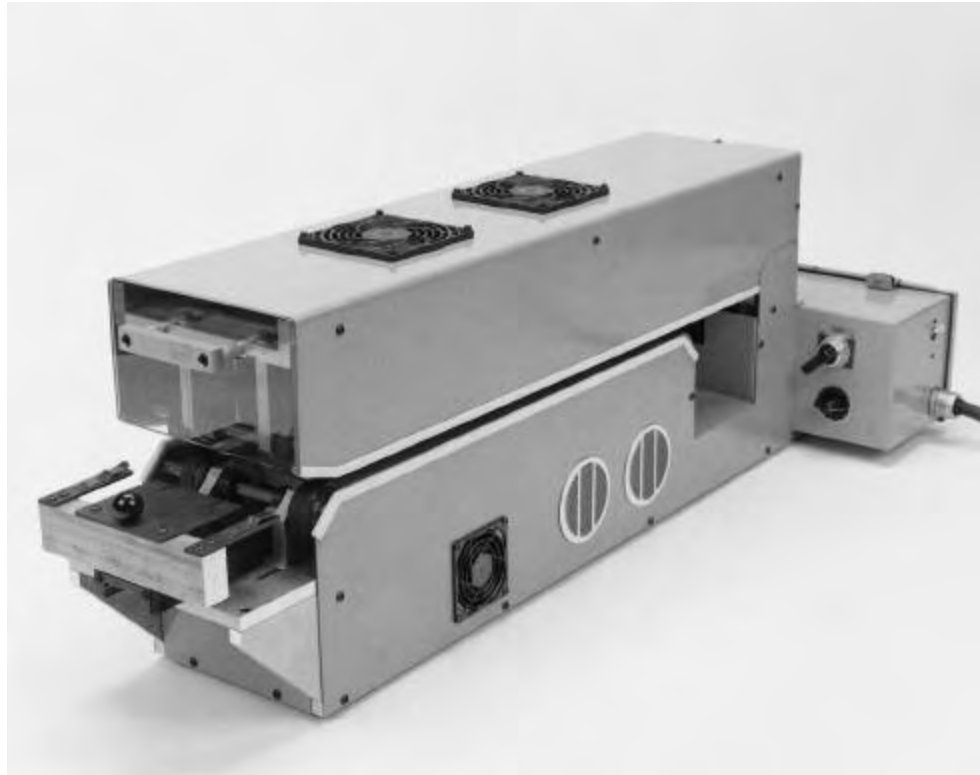

Applications

Designed for processing a broad range of heat-shrinkable tubing products up to 19 [75] in diameter and 101 [4.0] long. Suitable for either single-wall or adhesive-lined tubing. Heating-element temperature is adjustable up to 600°C [1112°F] and the belt speed is adjustable to 2.28 [7.5] per minute. Operator simply positions the heat-shrink tubing over the assembly and feeds it into the process chamber. Heating and cooling take place automatically with the cables or wires securely fixed.

Available in:	Americas	Europe	Asia Pacific
	■		■

Model 16B Belt Heater (Continued)

Specifications and Dimensions

Electrical	Part No. 827429-000	Part No. 047143-000	Part No. 584313-000
Power requirements	120 Vac, 1 Ø, 50/60 Hz, 20 A	220 Vac, 1 Ø, 50/60 Hz, 15 A, 3-wire	230 Vac, 1 Ø, 50/60 Hz, 15 A, 4-wire
Heating elements	875 W (upper and lower)	875 W (upper and lower)	875 W (upper and lower)

Mechanical

Conveyor belt system	Two sets of pinch belts right and left, four belts total		
Machine dimensions	48 cm [19 in] W x 110 cm [43 in] L x 33 cm [13 in] H		
Shipping dimensions	61 cm [24 in] W x 111 cm [44 in] L x 56 cm [42 in] H		
Machine weight without crate	55 Kg [120 lb]		
Shipping weight with crate	91 Kg [200 lb]		

Tubing Sizes

Inside diameter before recovery	Up to 19 mm [0.75 in]
Length	Up to 101mm [4.0 in]

Optional Attachment

Ring terminal kit	Part No. 060053-000
-------------------	---------------------

Product Facts

- Closed-loop speed and temperature control
- CE approved for worldwide use
- Adaptable for different applications
- Continuous controlled process

Available in:

- | | |
|--------------|---|
| Americas | ■ |
| Europe | ■ |
| Asia Pacific | ■ |

Model 19 Conveyor Heater for Processing Raychem Heat-Shrinkable Tubing and Termination Devices



Applications

The Model 19 conveyor heater is the latest generation of reliable and versatile process heaters for a wide variety of heat-shrinkable products.

Two sets of timing belts grip the individual assemblies and carry them through a closed-loop infrared heating zone, then through a cooling zone, and deposit the completed assemblies in a collection bin.

The processor was designed to meet the requirements of the European Safety Directives and is CE approved, allowing for worldwide use.

The processor is designed to operate on the following line voltages: 210 to 240 Vac, 20 A, 1 Ø, 50/60 Hz.

Options for this processor include:

- Powered or unpowered extension tables to support long or heavy harnesses.

- Kit for processing ring terminals and end terminations.
- Floor stand with wheels.
- Wider heating elements for tubing up to 178 [7.0] long.
- Narrow heating elements for SolderSleeve devices up to 10 [0.4] diameter and 45 [1.8] long or short length tubing less than 50 mm [2.0].

Product Features
Controlled Heating Zone

The Model 19 has two etched- foil heating elements mounted under a quartz face. Consistent heating chamber temperatures are obtained with a closed-loop temperature controller. There is a lockout on the controller to prevent unauthorized changes.

Speed Control

Consistent speed is obtained with a closed-loop speed controller. The speed is adjusted using a 3-digit thumbwheel on the front control panel. There is

a lockout on the thumb-wheel to prevent unauthorized changes.

Minimal Skill Requirements

There are clearly marked guides for aligning the assembly as well as the tubing or device being processed. The operator only has to center the assembly; the grippers carry it through the heating and cooling zone and deposit it into the unloading bin.

Economical Production

The throughput rate is determined by the rate at which an operator can load the processor.

Versatility

The tool description CLTEQ-M19-Belt-htr part number 714529-000 will handle tubing up to 25 [1.0] diameter and 102 [4.0] long. Tubing up to 178 [7.0] long can be handled with the use of tool description CLTEQ-M19-Belt-Htr-6in part number 075131-000. The tool description CLTEQ-M19-Beltheater-SS

part number D43037-000 will handle SolderSleeve devices up to 10 [0.4] diameter and 45 [1.8] long, or short length tubing (less than 50 [2.0], where applications require a narrow heat width.

Self-Diagnostic Circuitry

There are several "self-diagnostic" circuits that alert the operator if any major component fails or if an unsafe processing condition occurs. A light will turn on and a lockout gate will lift in the entry zone, preventing the operator from loading assemblies until the situation has been corrected.

Other Features Include:

- Emergency stop.
- Automatic cool-down circuit to extend the life of components.
- Lockout on temperature and speed controllers to prevent unauthorized changes.

Model 19 Conveyor Heater for Processing Raychem Heat-Shrinkable Tubing and Termination Devices (Continued)

Specifications and Dimensions

Electrical	
Power requirements	210–240 Vac, 20 A, 1 Ø, 50/60 Hz
Heating elements	Std = 3160 W/Wide = 3320 W/Narrow = 1760 W
Mechanical	
Conveyor belt system	Double-sided timing belts, pitch - 9.5 [0.375]
Belt speed	Up to 152 cm/min [5.0/min]
Processor dimensions	53 cm [21 in] W, 135 cm [53 in] L, 45 cm [18 in] H
Shipping dimensions	66 cm [26 in] W, 147 cm [58 in] L, 58 cm [23 in] H
Shipping weight with crate	86 Kg [190 lb]
Tubing sizes	
Tubing diameter (max)	25 mm [1.0 in]
Tubing length (max)	102 mm [4.0 in]
	178 mm [7.0 in] wide heating element tool 50 mm [2.0 in] narrow heating element tool
Work-piece length (min)	240 mm [9.5 in]
Version	
Model 19 Standard	Part No. 714529-000
Model 19 Wide	075131-000
Model 19 Narrow	D43037-000

Model 81CE Discrete Heater

Product Facts

- Closed-loop temperature control for a precise and repeatable thermal process
- Oven dwell time precisely set by a 3-digit thumb wheel digital timer
- Heat output can be controlled to accommodate a wide variety of applications
- Operation requires only minimal skill
- Contains numerous safety features
- Meets the requirements of CE, OSHA and the NEC



Applications

The Model 81CE is a discrete heater that can process large, complex assemblies or other suitable substrates using a wide variety of heat-shrinkable tubing products up to 25 mm [1.0] in diameter and 127 mm [5.0] in length. It is suitable for use with both single wall and adhesive-lined tubing. Two jaws grip the assembly or substrate, carry it into an infrared heating chamber for a user-selectable predetermined period of time, then return the completed assembly back to the start position for removal.

Available in:	Americas	Europe	Asia Pacific
	■	■	■

Specifications and Dimensions

Model 81CE Discrete Heater (Continued)

Electrical	Part No. 071965-000	Part No. 704393-000
Power requirements	120 VAC, 1Ø, 50/60 Hz, 15 A	220 VAC, 1Ø, 50/60 Hz, 15 A
Heating elements	Two 400 watt infrared stamped foil with infrared heating elements, one top and bottom.	Two 400 watt infrared stamped foil with infrared heating elements, one top and bottom.
Timing system	Eagle digital timer, 1 to 999 seconds	Eagle digital timer, 1 to 999 seconds
Pneumatic		
Requirements for jaw traverse	30-40 psi clean shop air	30-40 psi clean shop air
Dimensions		
Control box dimensions:		
Length	432 mm [17 in]	432 mm [17 in]
Width	216 mm [9 in]	216 mm [9 in]
Height	165 mm [7 in]	165 mm [7 in]
Control box weight	7.7 Kg [17 lb.]	7.7 kg [17 lb.]
Heating chamber dimensions:		
Length	380 mm [15 in]	380 mm [15 in]
Width	240 mm [10 in]	240 mm [10 in]
Height	343 mm [14 in]	343 mm [14 in]
Heating chamber weight	18 Kg [40 lb.]	18 kg [40 lb.]
Shipping Dimensions		
Length	610 mm [24 in]	610 mm [24 in]
Width	610 mm [24 in]	610 mm [24 in]
Height	530 mm [21 in]	530 mm [21 in]
Shipping weight	41 Kg [90 lb.]	41 kg [90 lb.]
Tubing Sizes		
Inside diameter before heat	Up to 25.4 mm [1 in]	Up to 25.4 mm [1 in]
Length	Up to 127 mm [5 in]	Up to 127 mm [5 in]

Model 105 Tunnel Oven

Product Facts

- Closed-loop temperature control for a precise and repeatable thermal process
- Conveyor speed precisely set by a 3-digit potentiometer
- Operation requires only minimal skill
- Contains numerous safety features
- Custom length conveyors for longer entry and/or exit sections available
- Optional accessories to customize the tunnel oven

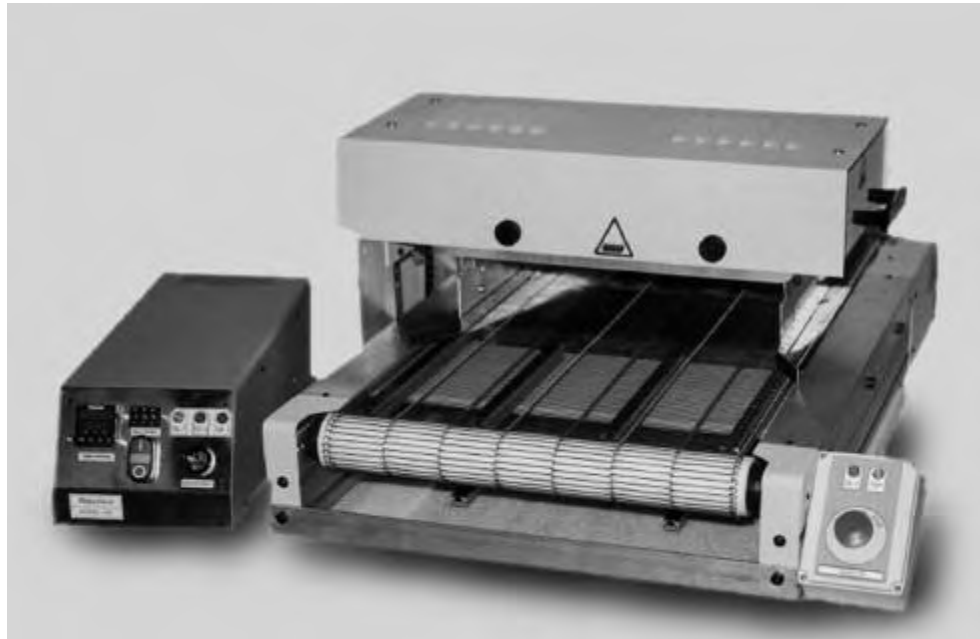

Applications

Table conveyor heater that provides a controlled process system suitable for installing a wide variety of heat-shrinkable tubing products up to 76 mm [3.0] diameter and unlimited in length. Ideally suited for efficient processing of fiber and fabric HFT and both single wall and dual wall tubing. Designed as an integrated modular unit. Assemblies are placed on the entry section of a mesh belt, transported through a heating chamber, across a bank of cooling fans then discharged from the rear of the conveyor.

Available in:	Americas	Europe	Asia Pacific
	■	■	■

Specifications and Dimensions

Model 105 Tunnel Oven (Continued)

Electrical	Part number 955018-000
Power requirements	208/240 VAC, 1Ø, 50/60 Hz, 15 A
Heating elements	Two 1500 watt infrared stamped foil with black quartz face, one top and bottom
Operating temperature	Ambient to 650°C [1202°F]
Drive System	DC motor with SCR drive controller and 3 digit speed potentiometer
Conveyor Speed	0.06 M/min. to 1.5 M/min. [0.20 to 5.0 ft/min]
Conveyor Belt	Wire mesh 70% open
Heater Oven Gap	2 Position; 53.6 mm [2.11 in] Lower Position, 98 mm [3.86 in] Upper Position
Effective heating width	356 mm [14 in]
Dimensions	
Control box dimensions	
Length	515 mm [20 in]
Width	210 mm [8 in]
Height	178 mm [7 in]
Control box weight	7.7 Kg [17 lb]
Heating conveyor dimensions	
Length	990 mm [39 in]
Width	685 mm [27 in]
Height	417 mm [17 in]
Heating conveyor weight	68 Kg [150 lb]
Shipping Dimensions	
Length	1346 mm [53 in]
Width	1168 mm [46 in]
Height	635 mm [25 in]
Shipping weight	146 Kg [320 lb]
Tubing sizes	
Inside diameter before heat	Up to 76.2 mm [3 in]
Length	
Perpendicular to belt travel	356 mm [14 in]
Parallel to belt travel	Unlimited

Optional Accessories

- Powered outboard conveyor for processing large assemblies that require only a portion of the assembly to be heated (1 side only).
- Powered entry and exit conveyors for processing long and rigid assemblies requiring entry and exit support of the product.
- Ability to add additional heater chambers to extended custom length wire mesh conveyors.
- Custom floor stands.

Installation of Splice Sealing Products Adjacent to Ultrasonic Welder

Product Facts

- Increased heating element life
- Installation times, temperatures and product size information (individual selection)
- Sequenced installations
- Operator key lock/password protection levels
- Automatic heater retraction on mains failure
- Automatic calibration (single cycle)
- RS232 interface allows time, temperature and product sizes for the next installation to be transferred from a remote machine (e.g. an ultrasonic welding tool)
- Machine hours and installation cycle counters
- Software upgradeable to support special applications
- Air cooling can be provided to an optional stub splice fixture in the RBK-Proc-MK2-Proc-Aircool version

RBK-ILS-Processor MkII



Applications

The RBK-ILS-Processor MkII is a semi-automatic unit designed specifically to install splice sealing products onto ultrasonically welded or crimped splice joints used in automotive harnesses.

The tool can operate in several modes:

- Stand-alone — operator sets time and temperature.
- Sequenced — preset times and temperatures can be sequenced automatically (and can also be randomly selected from sequence stored.)

- Automatic — communication with upstream ultrasonic welder can allow time and temperature to be automatically set without operator intervention. The operator is able to efficiently load both machines and so minimize 'dead time'. Installing Raychem splice sealing products immediately after welding gives reduced installation time and earliest possible mechanical protection for the welded joint. The operator positions the splice sealing product centrally over the splice joint and then locates the assembly into the gripper mechanism.

The wire assembly is automatically ejected, with the splice sealing product installed and the joint area sealed, insulated and strain relieved. In-line or stub-type splices can be installed.

Available in:	Americas	Europe	Asia Pacific
	■	■	■

Installation of Splice Sealing Products Adjacent to Ultrasonic Welder
(Continued)

RBK-ILS-Processor MkII (Continued)

Technical Specification

Electrical Supply	220V-240V-50Hz
Power Consumption	1.7 Amps (Max)
Operating Temperature	550°C [1022°F] (Max) (500°C [932°F] recommended)
Machine Cycle Times for splice sealing products used on typical range of automotive splices	6 to 20 seconds depending on wire size and the number of wires used
Total System Noise	<80dB
Dimensions	390 x 365 x 225 mm [15 x 14 x 9 in.]
Weight	18 Kg [40 lb]

Product Range

RBK-ILS-125 Products	Sizes 1 to 3A
RBK-ILS-85 Products	Sizes 6/1 to 12/3
For Other Raychem Products (eg. RBK-VWS, RBK-ESS....)	Contact Tyco Electronics

Ordering Information

	Description	Part No.
Equipment	RBK-Proc-Mk2-Processor	740331-000
	RBK-Proc-MK2-Proc-Aircool	A96930-000
Accessories	Stub splice fixture - RBK-ILS-Proc-Stub-Sp-Fix	981721-000
	Air cooled stub splice fixture - RBK-ILS-Proc-Air-Cool-Kit	843800-000
	8 mm ring terminal fixture - RBK-ILS-Proc-Termfix-08mm	049857-000

ThermoGun HG Hot-Air Heating Tool

Product Facts

- Stand-mounted or handheld, rugged unit for heavy-duty use
- Built-in stand and turbo-fan-driven blower
- Adjustable side vents
- Adjustable temperature
- 1680 to 2160 watts
- Large reflector size
- High heat output for fast installation

Applications

Used for installing molded parts onto adapters or harnesses and installing a broad range of heat-shrinkable products, including boots and tubing up to three inches in diameter..



Specifications

Model	Power Requirements	Input Watts	Temperature Range	CFM*	RPM**
HG-501A	120 V, 60 Hz, 14 A	1680	260°C–399°C [500°F–750°F]	23	1700
HG-502A	230 V, 50/60 Hz, 7 A	1680	260°C–399°C [500°F–750°F]	23	1700
HG-751A-C	120 V, 60 Hz, 18 A	2160	399°C–538°C [750°F–1000°F]	23	1700
HG-752A	230 V, 50/60 Hz, 9 A	1740	399°C–538°C [750°F–1000°F]	23	1700

*CFM = Cubic feet per minute.
 **RPM = Revolutions per minute.

Available in:	Americas	Europe	Asia Pacific
	■		■

ThermoGun HG Hot-Air Heating Tool (Continued)

Accessories



A-160-HG reflector (P/N 991017) for short lengths of tubing up to 19.05 [75] in diameter. Must be ordered separately.



A-170-HG reflector (P/N 991018) for short lengths of tubing 19.05–50.8 [1.75–2] in diameter. Must be ordered separately.



TG-23 reflector (P/N 991026) for boots up to 44.45 [1.75] in diameter. Must be ordered separately.

Ordering Information

Model*	Housing Color	Part No.
HG-501A	Red	462047-000
HG-502A	Red	389363-000
HG-751A-C	Red	926935-000
HG-752A	Red	026239-000

Accessories	Tubing Application	Part No.
A-160-HG standard reflector	Diameters up to 19.05 mm [0.75 in]	991017-000
A-170-HG large tubing reflector	Diameters of 19.05–50.8 mm [0.75–2 in]	991018-000
TG-23 small boot reflector	Diameters up to 44.5 mm [1.75 in]	991026-000
TG-24 large boot reflector	—	991027-000

*Complete with bench stand.

Table of Contents

Equivalents and Conversions 11-2, 11-3
Temperature Conversion Formula 11-4, 11-5
Glossary 11-6 to 11-18
Part Index 11-19 to 11-21



Decimal Equivalents

Equivalents and Conversions

Fraction of Inch	Decimal of Inch	Decimal Millimeters	Fraction of Inch	Decimal of Inch	Decimal Millimeters
	1/64	.0156		.5118	13.0000
	1/32	.0313		.5156	13.0969
		.0394	17/32	.5313	13.4938
	3/64	.0469		.5469	13.8906
1/16		.0625	35/64	.5512	14.0000
	5/64	.0781		.5625	14.2875
		.0787	9/16	.5781	14.6844
	3/32	.0938		.5906	15.0000
	7/64	.1094		.5938	15.0813
		.1181	19/32	.6094	15.4781
1/8		.1250		.6250	15.8750
	9/64	.1406	5/8	.6299	16.0000
	5/32	.1563		.6406	16.2719
		.1575	41/64	.6563	16.6688
	11/64	.1719		.6693	17.0000
3/16		.1875	21/32	.6719	17.0656
		.1969		.6750	17.4625
	13/64	.2031	43/64	.6875	17.6250
	7/32	.2188		.7031	17.8594
	15/64	.2344	45/64	.7087	18.0000
		.2362	23/32	.7188	18.2563
1/4		.2500		.7344	18.6531
	17/64	.2656	47/64	.7480	19.0000
		.2756		.7500	19.0500
	9/32	.2813	49/64	.7656	19.4469
	19/64	.2969		.7813	19.8438
		.2969	25/32	.7874	20.0000
5/16		.3125		.7969	20.2406
		.3150	51/64	.8125	20.6375
	21/64	.3281		.8125	20.6375
	11/32	.3438	13/16	.8268	21.0000
		.3543		.8281	21.0344
	23/64	.3594	53/64	.8438	21.4313
		.3594	27/32	.8594	21.8281
3/8		.3750		.8661	22.0000
	25/64	.3906	55/64	.8750	22.2250
		.3937		.8906	22.6219
	13/32	.4063	57/64	.9055	23.0000
	27/64	.4219		.9063	23.0188
		.4331	29/32	.9219	23.4156
7/16		.4375		.9375	23.8125
	29/64	.4531	59/64	.9449	24.0000
	15/32	.4688		.9531	24.2094
		.4724	61/64	.9688	24.6063
	31/64	.4844		.9843	25.0000
1/2		.5000	31/32	.9844	25.0031
			63/64	.9844	25.0031
			1	1.0000	25.4000

Conversion Factors

Prefixes (SI), Values,
and Symbols

Equivalents and Conversions (Continued)

Length	Area	Volume	Mass
Inches x 25.40 = Millimeters	Sq. inches x 6.452 = Sq. centimeters	Cu. inches x 16.39 = Cu. centimeters	Ounces x 28.35 = Grams
Millimeters x 0.03937 = Inches	Sq. centimeters x 0.1550 = Sq. inches	Cu. cm. x 0.06102 = Cu. inches	Grams x 0.03527 = Ounces
Feet x 0.3048 = Meters	Sq. feet x 0.0929 = Sq. meters	Cu. feet x 0.02832 = Cu. meters	Pounds x 0.4536 = Kilograms
Meters x 3.281 = Feet	Sq. meters x 10.76 = Sq. feet	Cu. meters x 35.31 = Cu. feet	Kilograms x 2.205 = Pounds
Miles x 1.609 = Kilometers	Sq. miles x 2.59 = Sq. kilometers		Kilograms/km x 0.6214 = Pounds/kft
Kilometers x 0.6214 = Miles	Sq. kilometers x 0.3861 = Sq. miles		Pounds/kft x 1.4881 = Kilograms/km
Ohms/km x 0.3048 = Ohms/kft	Circular mils x 0.7854 = Sq. mil		

Prefix	Value	Symbol	Prefix	Value	Symbol
Tera	10 ¹²	T	Deci	10 ⁻¹	d
Giga	10 ⁹	G	Centi	10 ⁻²	c
Mega	10 ⁶	M	Milli	10 ⁻³	m
Kilo	10 ³	k	Micro	10 ⁻⁶	μ
Hecto	10 ²	h	Nano	10 ⁻⁹	n
Deca	10 ¹	da	Pico	10 ⁻¹²	p

$^{\circ}\text{C} = (^{\circ}\text{F} - 32) \div 1.8$
 $^{\circ}\text{F} = (^{\circ}\text{C} \times 1.8) + 32$

Temperature Conversion Formula

$^{\circ}\text{F}$	$^{\circ}\text{C}$	$^{\circ}\text{F}$	$^{\circ}\text{C}$	$^{\circ}\text{F}$	$^{\circ}\text{C}$	$^{\circ}\text{F}$	$^{\circ}\text{C}$
-103	-75.00	-30	-34.44	25	-3.89	65	18.33
-101.2	-74.00	-28	-33.33	26	-3.33	66	18.89
-99.4	-73.00	-26	-32.22	27	-2.78	67	19.44
-97.6	-72.00	-24	-31.11	28	-2.22	68	20.00
-95.8	-71.00	-22	-30.00	29	-1.67	69	20.56
-94.0	-70.00	-20	-28.89	30	-1.11	70	21.11
-92.2	-69.00	-18	-27.78	31	-0.56	71	21.67
-90.4	-68.00	-16	-26.67	32	0.00	72	22.22
-88.6	-67.00	-14	-25.56	33	0.56	73	22.78
-86.8	-66.00	-12	-24.44	34	1.11	74	23.33
-85.0	-65.00	-10	-23.33	35	1.67	75	23.89
-83.2	-64.00	-8	-22.22	36	2.22	77	25.00
-81.4	-63.00	-6	-21.11	37	2.78	77	25.00
-79.6	-62.00	-4	-20.00	38	3.33	78	25.56
-77.8	-61.00	-2	-18.89	39	3.89	79	26.11
-76.0	-60.00	0	-17.78	40	4.44	80	26.67
-74.2	-59.00	1	-17.22	41	5.00	81	27.72
-72.4	-58.00	2	-16.67	42	5.56	82	27.78
-70.6	-57.00	3	-16.11	43	6.11	83	28.33
-68.8	-56.00	4	-15.56	44	6.67	84	28.89
-67.0	-55.00	5	-15.00	45	7.22	85	29.44
-65.2	-54.00	6	-14.44	46	7.78	86	30.00
-63.4	-53.00	7	-13.89	47	8.33	87	30.56
-61.6	-52.00	8	-13.33	48	8.89	88	31.11
-59.8	-51.00	9	-12.78	49	9.44	89	31.67
-58.0	-50.00	10	-12.22	50	10.00	90	32.22
-56.2	-49.00	11	-11.67	51	10.56	91	32.78
-54.4	-48.00	12	-11.11	52	11.11	92	33.33
-52.6	-47.00	13	-10.56	53	11.67	93	33.89
-50.8	-46.00	14	-10.00	54	12.22	94	34.44
-49.0	-45.00	15	-0.44	55	12.78	95	35.00
-47.2	-44.00	16	-8.89	56	13.33	96	35.56
-45.4	-43.00	17	-8.33	57	13.89	97	36.11
-43.6	-42.00	18	-7.78	58	14.44	98	36.67
-41.8	-41.00	19	-7.22	59	15.00	99	37.22
-40	-40.00	22	-6.11	60	15.56	100	37.78
-38	-38.89	21	-6.11	61	16.11	101	38.33
-36	-37.78	22	-5.56	62	16.67	102	38.88
-34	-36.67	23	-5.00	63	17.22	103	39.44
-32	-35.56	24	-4.44	64	17.78	104	40.00

°C = (°F - 32) ÷ 1.8
 °F = (°C x 1.8) + 32
 (Continued)

Temperature Conversion Formula (Continued)

°F	°C	°F	°C	°F	°C	°F	°C
105	40.55	145	62.78	185	85.00	325	162.78
106	41.11	146	63.33	186	85.55	330	165.56
107	41.66	147	63.88	187	86.11	335	168.33
108	42.22	148	64.44	189	87.22	340	171.11
109	42.77	149	65.00	189	87.22	345	173.89
110	43.33	150	65.56	190	87.78	350	176.67
111	43.88	151	66.11	191	88.33	355	179.44
112	44.44	152	66.66	192	88.88	360	182.22
113	45.00	153	67.22	193	89.44	365	185.00
114	45.55	154	67.77	194	90.00	370	187.78
115	46.11	155	68.33	195	90.55	375	190.55
116	46.66	156	68.88	196	91.11	380	193.33
117	47.22	157	69.44	197	91.66	385	196.11
118	47.77	158	70.00	198	92.22	390	198.89
119	48.33	159	70.55	199	92.77	395	201.67
120	48.89	160	71.11	200	93.33	400	204.44
121	49.44	161	71.66	205	96.11	405	207.22
122	50.00	162	72.22	210	98.89	410	210.00
123	50.55	163	72.77	215	101.67	415	212.78
124	51.11	164	73.33	220	104.44	425	215.56
125	51.67	165	73.89	225	107.22	425	218.33
126	52.22	166	74.44	230	110.00	430	221.11
127	52.77	167	75.00	235	112.78	435	223.89
128	53.33	168	75.55	240	115.56	440	226.67
129	53.88	169	76.11	245	118.33	445	229.44
130	54.44	170	76.67	250	121.11	450	232.22
131	55.00	171	77.22	255	123.89	455	235.00
133	56.11	172	77.77	260	126.67	460	237.78
133	56.11	173	78.33	265	129.44	465	240.55
134	56.66	174	78.88	270	132.22	470	243.33
135	57.22	175	79.44	275	135.00	475	246.11
136	57.77	176	80.00	280	137.78	480	248.89
137	58.33	177	80.55	285	140.55	485	251.67
138	58.88	178	81.11	290	143.33	490	254.44
139	59.44	179	81.66	295	146.11	495	257.22
140	60.00	180	82.22	300	148.89		
141	60.55	181	82.77	305	151.67		
142	61.11	182	83.33	310	154.44		
143	61.66	183	83.88	315	157.22		
144	62.22	184	84.44	320	160.00		

Glossary**Abrasion-resistance**

A measure of the ability of a wire or wire covering to resist damage by mechanical means.

Accelerated Aging

A test in which voltage, temperature, or other test parameters are increased above normal operating values to obtain observable deterioration in a relatively short time. The plotted results give service life within the context of the test.

Adapter

A device usually attached to the rear of connectors that provides for the attachment of harnessing components, such as strain-relief clamps, heat-shrinkable boots, and braid.

Adhesive Liner

Lining that melts and flows inside a sleeve or molded part, filling any voids in between the substrate and the sleeve or molded part. DuraSeal has an adhesive liner.

Adhesive (Hot Melt)

Dual-wall tubing and pre-coated molded parts whose inner layer melts and flows when heated, fills voids in the areas being covered, and forms a mechanical bond to the substrate.

Unlike an encapsulant, an adhesive forms a mechanical bond to the substrate.

Aging

Change in the properties of a material over time and under specific conditions. Generally refers to environmental stimulus such as heat and light.

Altitude Immersion Seal

A seal able to withstand substantial pressure change (for example, from sea level to 75,000 feet).

Amnesia

The tendency over time for a heat-shrinkable elastomeric tubing or molded part to fail to recover completely to its specified recovered size. See Shelf Life.

Ampacity

See Current-carrying Capacity.

ASTM**(American Society for Testing and Materials)**

A nonprofit industry wide organization that formulates test methods and material specifications, and publishes standards, testing methods, recommended practices, definitions, and other materials.

Attenuation

Power loss resulting in weaker signals in an electrical system as the signals travel along wires. In cables, generally expressed in dB per unit length, usually 100 feet.

AWG**(American Wire Gauge)**

The recognized method (in the United States) of specifying conductor size. The higher the gauge number, the smaller the conductor size.

Back-mounted

A termination assembly mounted from the inside of a panel or box with its mounting flange inside the equipment.

Band Marking

A continuous circumferential band applied to a wire at regular intervals for identification.

Bare Conductor

A conductor not covered with insulating material.

Barrel

- 1.) Connector barrel: The section of the terminal, splice, or contact that accommodates the stripped conductor.
- 2.) Insulation barrel: The section of the terminal, splice, or contact that accommodates the conductor insulation.
- 3.) Open barrel: The section of a cap that accommodates the conductor.

Batch Number

See Lot Number.

Bayonet Coupling

A quick-coupling device for plug and receptacle connectors. Mating is accomplished by rotation of the two parts under pressure.

Beaming

Crosslinking by means of high-energy electrons.

Binder

A spiral wrapping of a thread to hold together the members of a cable.

Blocking

The sticking together of insulated wires; usually caused by heat.

Body

A protective covering of resilient material over any portion of a cable, wire termination, or termination assembly in addition to normal jacketing of insulation, to prevent entry of moisture. Also, a form for holding potting compound.

Bonding Temperature

Temperature above which adhesive melts and flows sufficiently to form an adhesive bond between substrates.

Braid

A woven metallic or fiber layer applied over wire or cable to act as a protective barrier or shielding.

Glossary (Continued)

Braid Angle

The angle between the braid strands and the axis of the cable.

Breakdown Voltage

The voltage at which an insulator or dielectric fails to maintain the applied voltage.

Breakout

A region in a harness assembly where a wire or a group of wires is detached to form a separate, terminated branch. Also known as a transition.

Brittle Temperature

The temperature below which a material becomes brittle, often measured by a cold impact test.

Bunch Stranding

A method of twisting individual strands to form a finished stranded conductor. Specifically, a number of strands twisted together in a common direction and with a uniform pitch (or twist) per inch.

Bus

A communal circuit over which data or power is transmitted.

Cable

Two or more wires in a twisted or parallel configuration. Also, a shielded wire.

Cable Clamp

A mechanical clamp attached to the cable side of a termination assembly to support the cable or wire bundle. It provides strain relief and absorbs vibration and shock that would otherwise be transmitted by the cable terminations.

Cable Clamp Adapter

A mechanical adapter that attaches to the rear of a termination assembly to allow the attachment of a cable clamp.

Cable Sealing Clamp

A device consisting of a gland nut designed to seal around the jacket of a cable.

Cabler

A machine that mechanically assembles a group of insulated wires.

Cabling

The act of twisting together two or more insulated components to form a cable.

Capacitance

The ability of an insulation to store electrical energy. This is a function of the permittivity (dielectric constant) of the insulation. Usually expressed in pico farads/foot for a cable.

Carrier

A group of strands or ends used to form a finished braid.

Characteristic Impedance

The impedance of a transmission line that is independent of length. Also, the ratio of voltage to current at any point along a transmission line on which there are no standing waves.

Chemical Resistance

The ability of an insulation to withstand the presence of materials—such as acids, bases, water, salt water, and fuels—that can deteriorate the insulation, or that, if penetrable to the conductor, can cause dielectric loss of insulating qualities.

Cheminax Cables

Raychem's registered trade name for coaxial cables.

Circuit

The interconnection of a number of electrical elements or parts to accomplish a desired function.

Clocking

The arrangement of connector inserts, jackscrews, polarizing pins, sockets, keys/keyways, or housing configurations to prevent the mismatching or cross-mating of connectors. See also Polarization.

CMA (Circular Mil Area)

The unit for expressing the cross-sectional area of a conductor. Equal to the diameter of a conductor strand (expressed in mils) squared, times the number of strands.

Coax

See Coaxial Cable.

Coaxial Cable

A cable composed of two insulated conductors—such as a conductor and a shield—whose center axis is the same. Usually this term applies only to cable used in electronic signal circuits.

Cold Bend

A test conducted by wrapping tubing or cable around a mandrel or by bending it in an arc while at a low temperature.

Cold Flow

Permanent deformation of polymeric materials (insulation) at ambient temperature due to mechanical force or pressure (not due to heat softening).

Cold Impact

A test performed by subjecting a component to a specified impact during exposure to low temperature. It measures the brittleness of the material.

Cold Joint

A soldered joint made with insufficient heat. (Solder hasn't completely flowed and wet the substrate.)

Glossary (Continued)**Color Code**

A means of identifying cable components using solid colors or stripes. Also, the scheme that assigns a number from 0 to 9 for each of 10 colors.

Color Stability

The time and temperature ranges within which the color of a material will remain within the specified color limit.

Component

A wire or cable that is combined with other wires or cables to make a multicomponent cable.

Compound

An insulating or jacketing material made by formulating polymeric materials and additives.

Compound Under Strands (CUS)

A problem that occurs when loose stranding, or overheating during extrusion, allows compounds to get under individual strands of conductor.

Concentric Stranding

A method of stranding conductor. Specifically, the final conductor is built up in layers so that the inner diameter of a succeeding layer is always equal to the outer diameter of the underlying layer.

Concentricity

Ratio (expressed as a percentage) of the thinnest to the heaviest wall thickness. Measured on expanded or recovered tubing, or wire insulation, or jacketing.

Conductivity

The capability of a material to carry electrical current, usually expressed as a percentage of copper conductivity (copper being 100%). Specifically, the ratio of the current flow to the potential

difference causing the flow. The reciprocal of resistance.

Conductor

The metallic strand or strands used to carry an electric current.

Conductor Resistance

The resistance to flow of the electrical current along a conductor. Expressed in ohms/1000 feet. (Usually referenced to 20°C [68°F]).

Conduit

A tubular raceway for holding wires or cables.

Configuration

Arrangement of contacts in a multiple-contact connector.

Connector

A device used to physically and electrically connect two or more conductors.

Connector Classes

Categories based on shape, function, and smallest-size contact in a series.

Connector Insert

In connectors with metal shells, the part that holds contacts in proper arrangement while electrically insulating them from each other and from the shell.

Contact

The element in a connector that makes the actual electrical connection. Also the parts of a connector that actually carry the electrical current, and are touched together or separated to control the flow.

Contact Crimp

A contact whose rear portion is a hollow cylinder that accepts the conductor. A crimping tool is applied to swage or form the contact metal firmly against the conductor. Sometimes referred to as a solderless contact.

Contact Resistance

The direct-current resistance of a pair of mated contacts.

Contact Size

The diameter of the engagement end of a pin contact; also related to the current-carrying capacity of a contact.

Continuity

A continuous path for the flow of current in an electrical circuit.

Continuous Operating Temperature

Maximum temperature at which a component will maintain an acceptable life-time performance, based on accelerated aging prediction.

Continuous Service

Conditions (time, temperature, environment) that describe the lifetime requirements of a component.

Core

- 1.) In cables, a component or assembly of components over which additional components, such as a shield or a sheath, are applied.
- 2.) Inner wall of dual-wall heat-shrinkable tubing.

Coupling Ring

The portion of a plug that aids in the mating and demating of a plug and receptacle and holds the plug to the receptacle.

Cover, Electrical Connector

An item specifically designed to cover the mating end of a connector for mechanical and/or environmental protection. Also known as a dust cover.

Coverage

Glossary (Continued)

A calculated percentage that defines the completeness with which a braid or shield covers the surface of the underlying insulated conductor or conductors.

Crimp

Final configuration of a terminal barrel formed by the compression of the terminal barrel and conductor.

Crimping Die

Portion of the crimping tool that shapes the crimp.

Crimping Tool

Mechanism used for crimping.

Crosslinking

The formation of bonds between molecular chains in a polymer by means of chemical catalyzation or electron bombardment. The properties of the resulting thermosetting material are usually improved.

Crosslinking by Irradiation

A method of crosslinking polymers that makes a non-flowing material. This generally improves the properties of the polymer.

Crosstalk

Signal interference between adjacent conductors caused by a transfer of energy.

Crystallinity

The portion of polymer chains that are ordered in a regular (as opposed to amorphous) structure or a crystal lattice. Crystallinity tends to improve mechanical properties and fluid resistance. Crystalline or semicrystalline materials have a well-defined melting point (shrink temperature) at which the structure becomes disordered and the polymer flows.

CSA (Canadian Standards Association)

An agency that has developed standard specifications for products with particular emphasis on safety in the end use.

Curing

See Thermoset.

Current

A movement or flow of electrons. Also, the measure of this flow, expressed in amperes.

Current-carrying Capacity

The maximum current an insulated conductor is capable of carrying without exceeding its insulation- and /or jacket-temperature limitations under specified ambient conditions. Also known as ampacity.

Current Rating

The maximum continuous electrical flow of current for which a device is designed to conduct for a specified time at a specified operation temperature. Usually expressed in amperes.

Cutout

The hole, usually round or rectangular, cut into a metal panel in order to mount a connector. The cutout may also include holes for mounting screws or bolts.

Cut-through Resistance

Resistance of solid material to penetration by an object (typically a closely controlled knife edge) under conditions of pressure, temperature, and other elements.

Dielectric

Any insulating material between two conductors that permits electrostatic attraction and repulsion to take place across it. A material having electrical insulating properties.

Dielectric Breakdown

The voltage required to cause an electrical failure or breakthrough of the insulation. Determined by a destructive test. See also Breakdown Voltage.

Dielectric Constant (also K)

The ratio of the capacitance between two electrodes with a solid, liquid, or gaseous dielectric, to the capacitance with air between the electrodes. Also called permittivity and specific inductive capacity. Generally low values are desirable for insulation.

Dielectric Strength

The maximum voltage a dielectric can withstand without rupture. Usually expressed as volts per mil.

Dielectric Withstand Voltage (DWV)

A test voltage for a wire, cable, or insulation.

Direct Current Resistance (DCR)

The resistance offered by any circuit to the flow of direct current.

Direction of Lay

The lateral direction in which the strands or elements of a cable run over the top of the cable as they recede from the observer. Expressed as right-hand or left-hand lay.

Discontinuity

A broken connection, or the loss of a specific connection characteristic. Also, the temporary interruption or variation in current or voltage.

Dissipation Factor

The ratio between the permittivity and the conductivity of a dielectric.

Drain Wire

Glossary (Continued)

In a cable, an uninsulated conductor laid over the component, or components, in a foil-shield cable. Used as a ground connection.

Dust Cover

See Cover, Electrical Connector.

EID

See See Expanded ID.

Elastic Memory

The ability of a crosslinked polymer to be deformed to some predetermined shape, hold that shape for a period, and then return to its original shape upon the application of heat.

Elastomer

A material that exhibits very low or zero crystallinity and a high degree of flexibility (rubber is a synonym).

Elongation

The ultimate elongation, or elongation at rupture. Expressed as a percentage of original length.

EMI

Abbreviation for electromagnetic interference.

Encapsulant

Description related to the way dual-wall tubing products and pre-coated molded parts melt and flow when heated, filling any void in the area being covered. Unlike an adhesive, an encapsulant does not form a mechanical bond to the substrate.

Encapsulation

Covering and sealing.

End

The number of fibers or strands per carrier in braiding operations.

Environmentally Sealed

Description of a system to keep out moisture, dirt, air, or dust that might reduce performance.

Epoxy

A family of thermosetting resins usually used as adhesives or encapsulants.

ETFE

(Ethylenetetrafluoroethylene)

A fluoropolymer used as base resin for SPEC 55 wire and HCTE.

Expanded ID (EID)

The specified minimum (as supplied) internal diameter of tubing.

Expansion Ratio

An expression of how much larger the inside diameter of a tubing is before shrinking. Specifically, the relationship of the minimum (expanded) inside diameter of tubing to the maximum (recovered) inside diameter, expressed as a ratio. See also Shrink Ratio.

Extraction Tool

A tool used for removing contacts from a connector body.

Extrusion

A process that conveys plastic insulation material, generally via a screw, through forming dies and subsequently cools the insulation material to form a predetermined shape.

Feedthru (feedthrough)

A bushing in a wall or bulkhead with terminations on one or both sides.

Filler

A material used in a cable construction to fill large interstices, thus providing a round construction; can be shaped, round, or in mastic forms. A nonfunctional member used in a cable to provide a more circular cross section.

Flame-resistant

A descriptor applied to a material that is inherently resistant to burning.

Flame Retardant

A descriptor applied to a material that has been made or treated so as to resist burning.

Flat Braid

A braided shield composed of flat strands.

Flat Cable

A cable with each component in a single, flat plane.

Flat Conductor

A conductor having a rectangular cross section, as opposed to a round or square cross section.

Flex Life

A measure of the susceptibility of a conductor or other device to failure due to fatigue from repeated bending.

Fluoropolymer

A polymer that contains atoms of fluorine.

Flux

A liquid or solid that, when heated, exercises a cleaning and protective action upon surfaces. Used to promote or facilitate fusion during soldering or welding.

Front Release Contacts

Connector contacts that are released from the front side of the connector and then removed from the back, wire side of the connector.

Full Recovery Temperature, Minimum

See Recovery Temperature.

Gauge

A term used to denote the physical size of a wire. See also AWG.

Glossary (Continued)

Grounding Conductor

A conductor that provides a current return path from an electrical device to ground.

Hardness

A general term that correlates with strength, rigidity, and resistance to abrasion or penetration. Measured on Shore or Rockwell scales. See also Shore.

Harness

A system providing electrical connection between two or more points.

Heat Aging

A test that subjects components or materials to temperatures above normal operating values to evaluate changes in performance in order to predict service life. See also Accelerated Aging.

Heat Shock

A test to determine the stability of a material by continuously exposing it to an extremely high temperature for a short period of time. The test was developed both to demonstrate that the material is crosslinked and to observe any problems in dripping, cracking, or flowing.

Heat-Shrinkable Material

A polymeric material capable of being reduced in size when exposed to heat.

Hertz (Hz)

A measure of frequency equal to one cycle per second.

Hookup Wire and Cable

Wiring used to connect various points in electronic assemblies.

Hot-Melt Adhesive

An adhesive that becomes activated by heating. When heated, it melts, flows over

the substrate surface, and forms an adhesive bond. Reheating causes the adhesive to remelt.

ID (Internal Diameter)

The inside or internal diameter of a tubing.

Impedance

The total opposition that a circuit offers to the flow of alternating current or any other varying current at a particular frequency. The ohm is the unit of impedance. Admittance is the reciprocal of impedance.

Impulse Test

A high-voltage test designed to locate pinholes in the insulation of a wire or cable by applying a voltage while the wire or cable is being drawn through an electrode.

Insert Cavity (Connector)

A defined hole in the connector insert into which the contacts are inserted.

Insert

Meltable thermoplastic ring placed within a SolderSleeve device. Aids in encapsulation and sealing.

Insert (Connector)

Part that holds the contacts in their proper arrangement and electrically insulates them from each other and from the shell.

Insert Arrangement (Connector)

The number, spacing, and arrangement of contacts in a termination assembly.

Insertion Tool (Connector)

A tool used to insert removable contacts into a connector.

Inspection Hole

A hole placed at one end of a contact barrel to permit visual inspection, to ensure that the conductor has been inserted to the proper depth in the barrel prior to crimping or soldering.

Insulated Terminal

A solderless terminal with an insulated sleeve over the barrel to prevent a short circuit in certain installations.

Insulation, Electrical

A nonconductive material usually surrounding or separating two conductive materials. Often called the dielectric in cables designed for high-frequency use.

Insulation, Thermal

A nonconductive material that prevents the passage of heat.

Insulation Resistance

Minimum electrical resistance permitted between any pair of contacts and between conductors and grounding devices of the same connectors in various combinations. An indication of the insulating properties of a material.

Interconnection

The joining of one individual device with another.

Interstice

In a cable construction, the space or void left between or around the cabled components.

Irradiation

In insulations, the exposure of the material to high-energy emissions for the purpose of favorably altering the molecular structure via crosslinking.

Glossary (Continued)

Jackscrew

A screw attached to one half of a two-piece, multiple-contact connector and used to draw both halves together and to separate them.

Jacket

- 1.) A material covering over a wire or cable assembly.
- 2.) Outer covering of a dual-wall heat-shrinkable tubing.

Kapton

DuPont's trade name for polyimide film.

Key (Connector)

A short pin or other projection that slides into a mating slot or groove to guide two parts being assembled.

Keying (Connector)

Mechanical arrangement of guide pins and sockets, keying plugs, contacts, bosses, slots, keyways, inserts, or grooves in a connector housing, shell or insert that allows connectors of the same size and type to be lined up; used in situations where there is danger of making a wrong connection.

Keyway

The slot or groove in which a key slides.

kV (Kilovolt)

A unit equal to 1000 volts.

Kynar

Trade name (of Atofina Chemicals, Inc.) for polyvinylidene fluoride and its copolymers.

Lacing Cord or Twine

Used for lacing and tying cable forms, hookup wires, cable ends, cable bundles, and wire harness assemblies. Available in various materials and impregnants.

Lanyard

A device, attached to certain quick-disconnect connectors, that permits uncoupling and separation of connector halves by a pull on a wire or cable.

Lay

Refers to direction or sometimes the ratio of lay length to core diameter.

Lay Length

A term used in cable manufacturing to denote the distance of advance of one member, or a group of spirally twisted members in one turn, measured axially. The lay of any helical element of a cable or conductor is the axial length of a turn of the helix of that element.

Life Cycle

A test to determine the length of time before failure in a controlled, usually accelerated environment.

Liner

See Core.

Longitudinal Change (Shrink Tubing)

The change in length of tubing when recovered. Expressed in the percent of change from the original length.

Loss

Electrical energy that is dissipated as heat.

Loss Factor

The product of the power factor and dielectric constant of an insulating material.

Lot Number

The number that identifies one production run of material. Also known as a batch number.

Low-loss Dielectric

An insulating material that has a relatively low dielectric loss, such as polyethylene or Teflon®.

Lug

A termination, usually crimped or soldered to a conductor, that allows connection to be made with a retaining screw.

Marking

A printed identification number or symbol applied to the surface of a wire or cable.

Mate (Connections)

To join connector halves in a normal engaging mode.

Megarad

A unit for measuring radiation dosage.

Melt/Flow Index

Measurement of the flow of thermoplastic material under given conditions of temperature and pressure. Expressed as grams per unit of time.

Melting Point

The temperature at which crystallinity disappears when crystalline material is heated.

Mil

A unit equal to one one-thousandth of an inch (.001"); used in measuring the diameter of a conductor or thickness of insulation over a conductor.

MIL-SPEC

Abbreviation for Military Specification, which is a document the U.S. Government issues to define a product that will be used in military end-use applications.

TEFLON is a trademark of E.I. du Pont de Nemours and Company

Glossary (Continued)

Milking Off

Action that occurs when the inner layer (the encapsulant or adhesive) of the tubing or molded part acts as a lubricant, allowing the tubing to slip off the substrate (because the tubing wants to recover to a smaller diameter).

Minimum Full Recovery Temperature

See Recovery Temperature.

MO (Manufacturing Order)

A series of operation-work-order cards identifying materials to be used and the type and quantity of products to be manufactured. An MO is controlled and issued by Production Control to the manufacturing operation.

MOD Code (Material Modification Code)

A code designating a particular stage in the production process. Most MOD codes describe the way the product is packaged.

MS (Manufacturing Specification)

A set of process instructions used in the manufacturing of tubing products. Customer Logistics, Product Management, or Manufacturing Engineering initiate the MS; Manufacturing Engineering controls it. The product design and quality parameters are provided to Manufacturing Engineering by Product Development and Quality Assurance. Successful trial runs of a new product or design usually precede the initiation of an MS (see SMO). A proprietary Raychem document, an MS is not available to customers.

Multiconductor

More than one component within a single-cable complex.

Multiple-Conductor Cable

A combination of two or more components cabled together.

Nick

A small cut or notch in conductor strands or insulation.

Nominal

A descriptor applied to a dimension representing the center of the range of tolerance or a value if no tolerance is applied.

OFT (Optional Flame Test)

Canadian Standards Association's test for flame-retardance. Tubing with an OFT rating is highly flame-retardant.

Ohm

The unit of electrical resistance.

Operating Temperature

The maximum internal temperature at which a system, harness, or connector may operate in continuous service; generally expressed as a time and temperature.

Operating Temperature Range

The range between the maximum and the minimum internal temperature of insulation in a system, harness, or connector in continuous service. The lower limit is determined by low-temperature flex test.

Optional Flame Test

See OFT.

Packaging

The process of physically locating, connecting, and protecting devices or components.

Panel

The side or front (usually metal) of a piece of equipment on which connectors are mounted.

Panel-mount

Method of fixing one-half of a connector to a board, panel, or frame. Usually, the female half of the connector is the mounted portion and the male half is the removable portion.

PC (Production Control)

Group responsible for directing and regulating the movement of goods through the entire manufacturing cycle, from the requisitioning of raw materials to the delivery of the finished products.

PCN

See RPN.

Peripheral Seal

A seal provided around the periphery of connector inserts to prevent the ingress of fluids or contaminants at the perimeter of mated connectors.

Permittivity

See Dielectric Constant.

Pick

The number of crossovers of braiding units per inch of cable.

Pigtail

A short conductor or wire extending from an electrical or electronic device to serve as a jumper or ground connection.

Pin Contact

An electrical terminal, usually in a connector. Normally a smaller termination than a lug.

Plastic Deformation

Change in dimensions under a load that does not recover when the load is removed.

Plasticizer

A softener or lubricant added to a compound to make it easier to process or more flexible in use.

Plating



Glossary (Continued)

The overlaying of a thin coating of metal on metallic components to improve conductivity, facilitate soldering, or prevent corrosion.

Plug

The part of a connector that is normally "removable" from the other, permanently mounted part; usually that half of a two-piece connector that contains the pin contacts.

Plug Connector

An electrical connector that is intended to be attached to the free end of a conductor, wire, cable, or bundle, and that couples or mates to a receptacle connector.

Poke Through

A term describing stray wires in a solder joint that poke through the insulation.

Polarization (Connectors)

A mechanical arrangement of inserts or the shell configuration (referred to as clocking in some instances) that prohibits the mating of mismatched plugs and receptacles. See also Clocking.

Polyamide

A polymer formed by the reaction of a diamine and a diacid. Nylons are commercial polyamides characterized by toughness, solvent resistance, and sharp melting point.

Polymer

A material of high molecular weight formed by the chemical union of monomers.

Polyolefin

A family of polymers (such as polyethylene and polypropylene) made from olefin monomers.

Potting

The permanent sealing of the cable end of a connector with a compound or material that thermosets into an elastomer, to exclude moisture and/or to provide strain relief.

Pre-etching

The act of surface preparation before encapsulating.

Pretinned

Description of an electrical component to which solder has been applied prior to soldering.

Pretinned Solder Cup

Solder cup whose inner surfaces have been precoated with a small amount of solder.

Preform

Usually, the solder ring in a SolderSleeve device.

Primary Insulation

The inner member of a dual-wall wire insulation. The insulation applied directly on the conductor. Also referred to as the core. See also Core.

Push-back

That property of a braid or shield that allows the braid or shield to be pushed back easily along the cable core.

PVC (Polyvinyl chloride)

A polymer compound used as wire insulation.

PVDF

Polyvinylidene fluoride.

Quality Assurance

Systematic, planned, and documented activities designed to provide confidence that a product will meet specifications.

Quality Control

Activities that monitor, measure, and control the characteristics of a material, component, or product to documented specifications.

A type of connector shell that permits rapid locking and unlocking of two connector halves.

RA Flux

Rosin-activated flux.

Radiation Crosslinking

The act of crosslinking a material with ionizing radiation. (Most Raychem products are radiation crosslinked, with an electron beam as the form of ionizing radiation.) See also Crosslinking by Irradiation.

Rated Temperature

The maximum temperature at which a component can operate for extended periods with acceptable changes in its basic properties.

Rated Voltage

The maximum voltage at which an electric component can operate for extended periods without undue degradation.

Rear Release Contacts

Connector contacts designed to be released and removed from the rear (wire side) of the connector. The removal tool engages the contact from the rear and pulls the contact out of the connector contact retainer.

Receptacle

Usually the fixed or stationary half of a two-piece multiple contact connector. Also the connector half usually mounted on a panel and containing socket contacts.

Recover (Heat-shrinkable Components)

Activation of the elastic memory principle (usually with heat) to cause a tubing or molded part to return to its original size.

Recovered ID (RID)**Quick Disconnect**

Glossary (Continued)

In heat-shrink tubing, the guaranteed maximum internal diameter of tubing after being freely recovered.

Recovery Temperature

The minimum temperature required to fully shrink a product, that is, for the product to recover completely.

Removable Contact

A contact that can be mechanically joined to or removed from an insert. Usually special tools are required to lock the contact in place or remove it for repair or replacement.

Resistance

A measure of the difficulty in moving electrical current through a conductor or insulation when a voltage is applied. It is measured in ohms.

Ribbon Cable

Flat cable with conductors that have been individually insulated together. Its structure is usually characterized by individual colors of insulation for each conductor, although a single color may be used for all conductors.

RID

See Recovered ID.

RMA Flux

Rosin-mildly-activated flux.

Rope Lay

A type of conductor lay that uses stranded conductors as components to build a larger conductor.

RPN (Raychem Product Number)

A 10-digit number (such as 123456-4-001) assigned to every standard product and every product manufactured on a special manufacturing order (SMO). The first 6 digits represent the PCN (Product Control Number),

followed by a 1-digit MOD Code, and finally a 3-digit suffix. See also MOD Code and SMO.

RT and RW specifications

Specification that describes standard product properties. Qualification and acceptance inspection criteria are incorporated into RT and RW specifications. RT and RW specifications are issued and controlled by the Specifications Group.

SCD (Specification Control Drawing)

Drawing that defines configuration and material parameters. Issued and controlled by the specifications group, SCDs are frequently used in conjunction with RT Specifications for Thermofit products.

Scoop-proof

A feature that prevents the damage of contacts during misaligned mating.

Sealant

Soft, tacky, pliable material that seals where mechanical strength is not required.

Sealed

Environmentally protected by the thermoplastic inserts or core of encapsulant/adhesive that has melted down around the substrate.

Sealing Plug

A plug that is inserted to fill an unoccupied contact aperture in a termination assembly.

Secant Modulus

A measure of material stiffness; stiffer material has a higher secant modulus. More specifically, the secant modulus is the ratio of stress (nominal) to corresponding strain at any specified point on the stress-strain curve. It is

expressed in force per unit area (usually kilograms per square centimeters or pounds per square inch), and reported together with the specified stress or strain.

Service Life

Period of time during which the product is expected to perform satisfactorily.

Service Loop

The extra cable required at a breakout to facilitate maintenance and servicing.

Service Rating

The maximum voltage or current that a termination is designed to carry continuously.

Shelf Life

Generally, the length of time a product or material may be stored without deterioration. Specifically, the length of time during which shrink tubing will retain its expanded ID and return to its recovered ID. Usually not a concern—except for some “amnesic” materials. See Amnesia.

Shell (Connector)

The outside case, usually metallic, into which the insert (body) and contacts are assembled. Shells of mating connector halves usually provide for proper alignment and polarization as well as for protection of projecting contacts.

Shield

A conducting layer placed around an insulated conductor or cable to limit the penetration, or escape, of electric or electromagnetic fields, thereby preventing electromagnetic interference. The shield may be formed of metallic braid, metal tape, metal-backed foil, metal tube, or conductive polymer. Usually grounded, the shielding is

Glossary (Continued)

carried through the connector shell, or through a special internal shell in the case of individual coaxial contacts.

Shielding

See Shield.

Shielding Effectiveness (SE)

The reduction in field strength resulting from interposing a metallic barrier between a source and receptor of electromagnetic energy.

Shore

A scale for comparing hardness. Higher Shore values represent harder materials. The hardness of a polymer, for example, is usually represented as Shore A or Shore D, with D being harder.

Shrink Ratio

An expression of how much the inside diameter of shrink tubing will reduce in size when recovered. The inverse of the expansion ratio. See also Expansion Ratio.

Shrink Temperature, Minimum

The minimum temperature at which a product begins to recover.

Signal Cable

A cable designed to carry current of less than 12 amperes per conductor.

Skew

Any out-of-squareness of the cut end of a piece of tubing after shrinking.

SMO (Special Manufacturing Order)

An order to evaluate manufacturing and production capability for a new or changed design for a customer and to provide development samples of potential products for customers. SMO products are separate and distinct from

standard products. New, potential products are usually run as SMO products for a minimum of three times before being considered for manufacture as a standard product.

Solder

An alloy that melts at relatively low temperatures and is used to join metals with higher melt points.

Solder Contact

A contact or terminal having a cup, hollow cylinder, eyelet, or hook to accept a wire for a conventional soldered termination.

Solder Cup

A tubular end of a terminal into which a wire conductor is inserted prior to being soldered.

Solderability

The property of a metal surface that allows it to be readily wetted by molten solder. See also Wetting.

Soldering

A process of joining metallic surfaces with solder without melting the base metal.

SolderSleeve Device

A device of flux-coated solder preform encapsulated in a heat-recoverable plastic sleeve. Upon the application of heat, the flux and solder will melt and flow as the sleeve recovers, forcing the solder around and onto the metallic parts being joined, thus forming an electrically insulated and strain-relieved joint.

Solid Conductor

A conductor composed of one single strand.

Solvent Resistance

The ability of a material to retain physical and electrical properties after being immersed in specific solvents.

SPC

Silver-plated copper.

SPC (Statistical Process Control)

The use of statistical techniques such as control charts to analyze a process or its output so as to take appropriate actions to achieve and maintain a state of control and to improve the capability of the process.

Specific Gravity

The ratio of the density (mass per unit volume) of a material to that of water.

Specific Inductive Capacity

See Dielectric Constant.

Splice

A joint connecting conductors with good mechanical strength and conductivity; a terminal that permanently joins two or more wires.

Strain Relief

The technique for or act of removing or lessening the strain or stress on a joint, splice, or termination. SolderSleeve devices provide strain relief.

Strain Relief Clamp

See Cable Clamp.

Strand

A single unit of a conductor.

Stranded Conductor

A conductor composed of more than one single strand. The strands in stranded conductors are usually twisted or braided together.

Strip

To remove insulation from a wire or cable.

Stripe

Glossary (Continued)

A continuous longitudinal or spiral color strip applied on the surface of a wire, cable, or tubing for identification.

Substrate

The material—such as a wire, post, or tab—over which an interconnection device is used.

Surface Resistance

The ratio of the direct current applied to an insulation system to the current that passes across the surface of the system.

Tape Wrap

A term denoting a spirally or longitudinally applied tape material wrapped around insulated or uninsulated wire and used as a mechanical barrier.

TC

Tinned copper.

Tear Test

A test to determine the tear strength of an insulating material. Usually includes exposure to given thermal conditions or a programmed series of conditions for prescribed periods of time.

Temperature Rating

The maximum temperature at which the insulating material may be used in continuous operation without loss of its basic properties. Usually time dependent.

Tensile Strength

The pull stress (in force per unit area) required to break a given specimen.

Thermal Rating

The effect of heat or cold applied at such a rate that nonuniform thermal expansion or contraction occurs within a given material or combination of materials. In electrical terminations, the effect can cause inserts and other insulation material

to pull away from the metal parts.

Thermal Shock

The effect of high and low temperatures applied at a rapid rate such that nonuniform thermal expansion or contraction occurs within a given material or combination of materials. The result could be stress-cracking or -shattering of material.

Thermochromic Indicator

Special compound that changes color when the proper wetting temperature has been reached in the solder joint.

Thermoplastic

A material that softens (melts and flows) when heated and becomes firm when cooled. A type of plastic that can be remelted a number of times without any important change in properties. Nylon, GE's Lexan, and PVC—examples of this type of plastic—are resilient after molding.

Thermoset

A material that hardens or sets when heated and, once set, cannot be resoftened by heating. This application of heat is called "curing."

Thermosetting Plastic

A type of plastic in which an irreversible chemical reaction takes place while the plastic is being molded under heat and pressure.

Thermosetting Adhesive

A curing adhesive that requires heat to promote curing. This type of plastic will not soften when reheated. See Epoxy.

Tolerance

The total amount by which a quantity is allowed to vary from nominal; thus, the tolerance is half the algebraic difference between the

maximum and minimum limits.

Traceability

The ability to trace the history, application, or location of an item and like items or activities by means of recorded identification. The lot number/manufacturing order (MO) number, or SMO number used to identify items or groups of items is traceable back to inspection and procurement records.

Transmission Cable

Two or more transmission lines. If the structure is flat, it is sometimes called flat transmission cable to differentiate it from a round structure such as a jacketed group of coaxial cables. See also Transmission Line.

Transmission Line

A signal-carrying circuit with controlled electrical characteristics; used to transmit high-frequency or narrow-pulse signals.

Triaxial Cable

A concentrically constructed cable, with a common axis, composed of a center conductor, first shield, and second shield, all insulated from each other.

UL (Underwriters' Laboratories)

A nonprofit independent testing organization that operates a listing service for electrical and electronic materials and equipment.

Ultraviolet Degradation

The degradation caused by long-time exposure of a material to sunlight or other ultraviolet rays.

Velocity of Propagation

The ratio of the speed of a radio frequency wave within a cable or dielectric as compared with the same wave in free space.

Voltage

Glossary (Continued)

The term most often used in place of electromotive force, potential, potential difference, or voltage drop to designate the electric pressure that exists between two points and that is capable of producing a current when a closed circuit is connected between the two points.

Voltage Breakdown

The voltage necessary to cause insulation failure.

Voltage Drop

Loss of voltage through a connection or conductor.

Voltage Rating

The voltage that may be continuously applied to wire.

Volume Resistivity

Reciprocal of conductivity; the resistance of a material to the flow of electrical current, usually expressed in ohm-cm.

VSWR (Voltage Standing Wave Ratio)

A measure of the uniformity of impedance along a transmission line, or the quality of the impedance match between a line and the source or load.

VW-1

A rating determined by the Underwriters' Laboratories' (UL) optional Vertical Wire Flame Test—the most difficult flame test for tubing. Tubings with a VW-1 rating are highly flame-retardant.

Wall Thickness

The thickness of the applied insulation or jacket.

Water Absorption Test

A method to determine the water uptake of a material. It is time and temperature dependent.

Water Blocking

The sticking together of insulated wires; usually caused by heat.

Wetting (Solder)

The formation of a relatively uniform, smooth, unbroken, and adherent film of solder to a base metal. Also, the free flow of solder alloy, with proper application of heat and flux, on a metallic surface to produce an adherent bond.

Wicking

The longitudinal flow of a liquid in a wire or cable construction due to capillary action. (This may also apply to solder.)

Wire

A single conductor covered with insulation.

Wire Dress

The orderly arrangement of wires and laced harnesses.

Withstanding Voltage

The test voltage an electrical connector can withstand for one minute without showing evidence of electrical breakdown when the voltage is applied between conductors and grounding devices of the connectors in various combinations.

Part Index

Product or Part Number	Page Number
-3 Material	4-25
-4 Material	4-27
-12 Material	4-29
-25 Material	4-31
-25S Material	4-33
-50 Material	4-35
-51 Material	4-37
-55 Material	4-39
-71 Material	4-41
-100 Material	4-43
-100S Material	4-45
-125 Material	4-47
101A011 to 094	4-49
10612	8-78
10613	8-78
10614	8-78
202A111 to 196	4-53
202C611 to 663	4-54
202D121 to 196	4-55
202D211 to 299	4-56
202D921 to 963	4-57
202F211 to 274	4-58
202G211 to 253	4-59
202G611 to 653	4-60
202K121 to 185	4-61
202W302 to 342	4-91
207W213 to 256	4-75
214A011 to 052	4-62
214A311 to 352	4-63
214P009 to 037	4-64
222A111 to 196	4-65
222D121 to 196	4-66
222D211 to 299	4-67
222D921 to 963	4-68
222F211 to 285	4-69
222K121 to 185	4-70
234A011 to 071	4-71
234A111 to 152	4-72
234A611 to 671	4-73
242W042 to 63	4-74
301A011 to 048	4-76
301A511 to 514	4-77
322A112 to 158	4-78
342A012 to 058	4-79
362A014 to 114	4-80
381A301 to 304	4-81
382A012 to 046	4-82
382C312, 322 & 332	4-83
400W242	4-93
462A011 to 060	4-84
462A421 to 424	4-85
562A011 to 067	4-86
7724 H 0664	8-78
AA-400 Super Heater	10-2
AD-1319-9 Holding Fixture Tool	10-3

Product or Part Number	Page Number
AD-1377, AD-1522 Hand Operated Crimp Tools	10-4
AD-3050-SEAL-TEST-EQUIP	10-5
AD-5000 and RH-396X Tinel-Lock Tools	10-7
AD-5010-Tinel-Bench-230V	10-9
Adhesives	5-2 to 5-7
ATUM Tubing	3-33
B-02X/04X	8-51
B-046	8-53
B-106	8-27 to 8-31
B-202	8-64
BSTS/BSTS-FR	3-53
C-203	8-20, 8-21
CES	4-95
CGPE-105	3-7
CGPT	3-9
Cheminax Coaxial Cables	9-68 to 9-72
Cheminax Twin Axial Cable	9-73, 9-74
Code 18 MIL-C-5015 (MS3100)	6-28 to 6-36
Code 21 MIL-C-26482 Series 1	6-37 to 6-43
Code 32 MIL-C-22992	6-44 to 6-49
Code 40 MIL-C-38999 Series III and IV	6-50 to 6-57
Code 41 MIL-C-38999 Series I and II	6-58 to 6-65
Code 54 MIL-C-5015 (MS3400), MIL-C-26482 Series 2, MIL-C-83723 Series I and III, MIL-C-81703 Series III	6-66 to 6-73
Code 76 BS 9522 F0017 (Pattern 105)	6-74 to 6-76
Computer aided design	9-89
Conductor sizes, strandings and resistance	9-94, 9-95
CRES-Lock Bands	6-27
CRN	3-11
CV-1981, CV-1983	10-11
CWT	8-6, 8-40, 8-44, 8-51
CWT-15XX	8-40
CWT-900X	8-7
D-71X	8-41
D-110	8-6, 8-8, 8-41
D-129	8-40 to 8-42
D-141	8-40 to 8-42
D-150	8-62, 8-63, 8-64 8-90
D-181	8-51, 8-52
D-184	8-51, 8-52
D-406	8-18, 8-19
D-436	8-23, 8-24
D-500	8-79 to 8-86, 8-90, 8-97
D-600	8-75, 8-90
D-602	8-67 to 8-74
D-607	8-53
D-609	8-24
D-621	8-90 to 8-93
D-1744	8-6, 8-9
Data Bus Accessories	8-89 to 8-93
Data Bus Box Couplers	8-85, 8-86
Data Bus Cables	8-77, 8-78
Data Bus Customer-Specified Harness Assemblies and HarnWare Software	8-98

Part Index (Continued)

Product or Part Number	Page Number
Data Bus Discrete Connectors	8-87, 8-88
Data Bus In-line Microcouplers	8-79 to 8-81
Data Bus Space-Grade Components	8-95 to 8-97
Data Bus Triaxial Size 8 Contacts	8-94
Data Bus Ultra Lightweight In-line Microcouplers	8-82
DCPT	3-13
DK-3716	8-93
DK-602	8-94
DK-621	8-87, 8-91, 8-92, 8-93, 8-97
DR-25	3-65
DuraSeal Crimp Terminals & Disconnects	8-27 to 8-32
DuraSeal Crimp Splices	8-18, 8-19
DWP-125	3-35
Electrical Shielding	9-87, 9-88
ElectroLoss FilterLine	9-63 to 9-67
ES1000	3-37
ES2000	3-39
ES Caps	3-67
FDR 25	9-79
Fiber Optic Cables	9-96 to 9-99
FL2500	3-41
FlexLine Wire & Cable	9-25
FlexLite Wire & Cable	9-45
FlexLite DW Wire	9-47
FlexLite HT Wire	9-53
FlexLite MT Wire	9-51
FlexLite TW Wire	9-49
FlexLite TX Wire	9-55
FLT Wire	9-57
FR-1000 Cable	9-27 to 9-34
HarnWare Harness Design Software	2-6 to 2-14
HCTE	3-69
HexaShield High Performance Adapters	8-99 to 8-104
HF	3-55
HFT5000	3-71
HL1802E/HL2005E	10-13
HRHF/HRNF/HRSR	3-57
HTAT	3-43
IR-1891	10-15
IR-550 Mark II	10-17
IR-1759 MiniRay	10-18
KTKK Product Family Overview	7-2
KTKK Assemblies	7-3 to 7-5
LSTT	3-15
MicroFit Tubing	3-73
MiniSeal Crimp Splices	8-22 to 8-25
Model 16B Belt Heater	10-19
Model 19 Conveyor Heater	10-21
Model 81CE Discrete Heater	10-23
Model 105 Tunnel Oven	10-25
MT1000	3-75
MT2000	3-77
MT3000	3-79
MT5000	3-81
MTC Crimp Connectors	8-105 to 8-111
MTCP-122	8-106 to 8-108

Product or Part Number	Page Number
Multiconductor, Custom-Designed, (multi) Cables	9-75
Multiconductor (Multicore) Cables	9-76
NT	3-83
NT-MIL	3-85
NTFR	3-87
PD Caps	3-89
Power Cables (Type TR, FTR, AFR, ZHI, ZHPCG)	9-90
PolyCrimp Wire Splices	8-20, 8-21
QFT	4-87
RayBlock 85 Tubing	3-91
RayBlock 105 Tubing	3-93
Rayflex Polyester Sleeving	3-95
Rayflex PETM	3-97
RayOLOn Kits	4-99
Rayrim Edging Material	3-99
Raythane, Neoprene, Rayolin, AFR	9-86
RBD	8-58
RBK-ILS-Processor MkII	10-27
RCW	9-19 to 9-24
RF One-step BNC/TNC Connectors	8-55 to 8-60
RHW	3-59
RMW	3-61
RNF-100	3-17
RNF-150	3-101
RNF-3000	3-19
RP-4800	3-21
RPPM	3-45
RT-3	3-23
RT-375	3-103
RT-555	3-105
RTD	8-59, 8-60
RW-175	3-107
S-1006	5-2
S-1009	5-2
S-1017	5-2
S-1030, S-1048, S-1275 (Rayaten)	5-2, 7-9
S-1124	5-2
S-1125	5-2
S-1255	5-2
S-1278	5-2
S-1297	5-2
S-1305	5-2
S01	8-44 to 8-49
S02	8-44 to 8-49
S03	8-46, 8-47
SCL	3-47
SCT	3-49
SESK (Shipboard Electrical Splice Kits)	7-10 to 7-12
SFR	3-109
SGRP	8-12 to 8-17
SGRS	8-12 to 8-17
SGRT	8-33 to 8-36
Ship or Shore Breakout Kits	7-13
shrinkHOoP Grommet	4-101
SO63	8-44 to 8-49

Part Index (Continued)

Product or Part Number	Page Number
SO96	8-44 to 8-49
SO175	8-44 to 8-49
SolderGrip Self-fixturing Insulated Terminals	8-33 to 8-37
SolderGrip Closed End Connector Splices	8-12 to 8-17
SolderShield Shielded and Coaxial Cable Splices	8-62 to 8-65
SolderSleeve Discrete Wire Terminators	8-39 to 8-42
SolderSleeve Coaxial Cable Terminators	8-51, 8-52
SolderSleeve PCB/Coaxial Cable Terminators	8-53, 8-54
SolderSleeve Shield Terminators	8-44 to 8-49
SolderSleeve Wire Splices	8-6 to 8-11
SolderTacts Shielded One-piece Solder Contacts	8-67 to 8-75
SPEC 44 Wire	9-3 to 9-9
SPEC 55 Wire	9-10 to 9-18
SPEC 80 Wire	9-25, 9-26
SRFR	3-111
SSC	4-51
SSB, D, T, F to 8S	4-89
SST/SST-FR	3-63
TAT-125	3-51

Product or Part Number	Page Number
TCFS/R Cable Feedthroughs	7-6 to 7-8
TFE and TFE-R	3-113
Thermocouple Extension Cable	9-60
ThermoGun HG Hot-Air Heating Tool	10-29
Thermorad HTF/Fluoroelastomer	9-84
Thermorad/Thermorad F	9-85
Tinel-Lock Ring	6-26
TUGA-GP	3-25
Type 99M Wire and Cable	9-35 to 9-38
Versafit Tubing	3-27
Versafit V2 Tubing	3-29
Versafit V4 Tubing	3-31
Viton® (E, HW, TW)	3-115
XFFR	3-117
XL Products	4-104, 4-105
Zerohal Wire and Cable	9-81 to 9-83
Zerohal 100A Wire and Cable	9-39
Zerohal 100G Wire and Cable	9-42
ZH-100	3-119
ZHTM	3-121

VITON is a trademark of Dupont Dow Elastomers LLC.

Catalog 1654025
Revised 12-04

www.tycoelectronics.com

Dimensions are in millimeters and inches unless otherwise specified. Values in brackets are U.S. equivalents.

Dimensions are shown for reference purposes only. Specifications subject to change.

USA: 1-800-522-6752
Canada: 1-905-470-4425
Mexico: 01-800-733-8926
C. America: 52-55-5-729-0425

South America: 55-11-3611-1514
Japan: 81-44-900-5102
Singapore: 65-4866-151
UK: 44-1793-528171

