

# Microwave MLC's

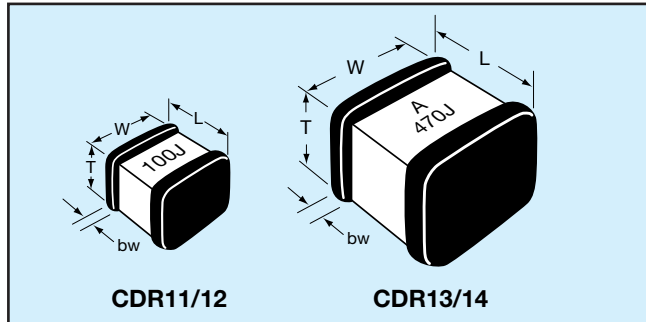

## CDR Series — MIL-PRF-55681 (RF/Microwave Chips)

### MILITARY DESIGNATION PER MIL-PRF-55681



### CROSS REFERENCE: AVX/MIL-PRF-55681

Per MIL-C-55681	AVX Style	Length (L)	Width (W)	Thickness (T)		Termination Band (bw)	
				Max	Min	Max	Min
CDR11	AQ11	.055±.015 (1.40±.381)	.055±.015 (1.40±.381)	.057 (1.45)	.020 (.508)	.020 (.508)	.005 (.127)
CDR12	AQ12	.055±.025 (1.40±.635)	.055±.015 (1.40±.381)	.057 (1.45)	.020 (.508)	.020 (.508)	.005 (.127)
CDR13	AQ13	.110±.020 (2.79±.508)	.110±.020 (2.79±.508)	.102 (2.59)	.030 (.762)	.025 (.635)	.005 (.127)
CDR14	AQ14	.110 +.035 -0.20 (2.79 +.889 -.508)	.110±.020 (2.79±.508)	.102 (2.59)	.030 (.762)	.025 (.635)	.005 (.127)

### HOW TO ORDER

**CDR12**

**MIL Style**  
CDR11, CDR12,  
CDR13, CDR14

**BG**

**Voltage  
Temperature  
Limits**

BG = +90±20 ppm/°C with and without  
rated voltage from -55°C to + 125°C  
BP = 0±30ppm/°C with and without  
rated voltage from -55°C to +125°C

**101**

**Capacitance**

EIA Capacitance Code in pF.  
First two digits = significant figures  
or "R" for decimal place.  
Third digit = number of zeros or  
after "R" significant figures.

**A**

**Rated Voltage  
Code**

A = 50V  
B = 100V  
C = 200V  
D = 300V  
E = 500V

**K**

**Capacitance  
Tolerance Code**

B = ±.1 pF  
C = ±.25 pF  
D = ±.5 pF  
F = ±1%  
G = ±2%  
J = ±5%  
K = ±10%  
M = ±20%

**U**

**Termination  
Finish (Military  
Designations)  
Code**

M = Palladium/Silver (CDR11 & 13 only)  
N = Silver, Nickel, Gold (CDR11 & 13 only)  
S = Solder Coated, Final (CDR12 & 14 only)  
U = Base Metallization, Barrier Metal, Solder  
Coated. (Solder M.P. 200°C or less)  
(CDR12 & 14 only)  
W = Base Metallization, Barrier Metal,  
Tinned (Tin or Tin/Lead Alloy)  
(CDR12 & 14 only)  
Y = 100% Tin  
Z = Base Metallization, Barrier Metal  
(Tin Lead Alloy With 4% Lead Min.)

**S**

**Failure Rate  
Level**

M = 1.0%  
P = .1%  
R = .01%  
S = .001%

6

### PACKAGING

Standard Packaging Quantity

CDR11-12 = 100 pcs per waffle pack

CDR13-14 = 80 pcs per waffle pack

**TAPE & REEL:** All tape and reel specifications are in compliance with EIA RS481 (equivalent to IEC 286 part 3).

Sizes SQCA through SQCB, CDR11/12 through 13/14.

—8mm carrier

—7" reel: ≤0.040" thickness = 2000 pcs  
≤0.075" thickness = 2000 pcs

—13" reel: ≤0.075" thickness = 10,000 pcs

110



**TABLE I: STYLES CDR11 AND CDR12 CAPACITOR CHARACTERISTICS**

Type Designation 1/	Capacitance in pF	Capacitance tolerance	Rated temperature and V/Temperature	WVDC	Type Designation 1/	Capacitance in pF	Capacitance tolerance	Rated temperature and V/Temperature	WVDC
CDR1 -B-0R1AB--	0.1	B	BG, BP	50	CDR1 -B-300A--	30	F, G, J, K, M	BG, BP	50
CDR1 -B-0R2AB--	0.2	B	BG, BP	50	CDR1 -B-330A--	33	F, G, J, K, M	BG, BP	50
CDR1 -B-0R3A---	0.3	B, C	BG, BP	50	CDR1 -B-360A--	36	F, G, J, K, M	BG, BP	50
CDR1 -B-0R4A---	0.4	B, C	BG, BP	50	CDR1 -B-390A--	39	F, G, J, K, M	BG, BP	50
CDR1 -B-0R5A---	0.5	B, C, D	BG, BP	50	CDR1 -B-430A--	43	F, G, J, K, M	BG, BP	50
CDR1 -B-0R6A---	0.6	B, C, D	BG, BP	50	CDR1 -B-470A--	47	F, G, J, K, M	BG, BP	50
CDR1 -B-0R7A---	0.7	B, C, D	BG, BP	50	CDR1 -B-510A--	51	F, G, J, K, M	BG, BP	50
CDR1 -B-0R8A---	0.8	B, C, D	BG, BP	50	CDR1 -B-560A--	56	F, G, J, K, M	BG, BP	50
CDR1 -B-0R9A---	0.9	B, C, D	BG, BP	50	CDR1 -B-620A--	62	F, G, J, K, M	BG, BP	50
CDR1 -B-1R0A---	1.0	B, C, D	BG, BP	50	CDR1 -B-680A--	68	F, G, J, K, M	BG, BP	50
CDR1 -B-1R1A---	1.1	B, C, D	BG, BP	50	CDR1 -B-750A--	75	F, G, J, K, M	BG, BP	50
CDR1 -B-1R2A---	1.2	B, C, D	BG, BP	50	CDR1 -B-820A--	82	F, G, J, K, M	BG, BP	50
CDR1 -B-1R3A---	1.3	B, C, D	BG, BP	50	CDR1 -B-910A--	91	F, G, J, K, M	BG, BP	50
CDR1 -B-1R4A---	1.4	B, C, D	BG, BP	50	CDR1 -B-101A--	100	F, G, J, K, M	BG, BP	50
CDR1 -B-1R5A---	1.5	B, C, D	BG, BP	50	CDR1 -B-111A--	110	F, G, J, K, M	BP	50
CDR1 -B-1R6A---	1.6	B, C, D	BG, BP	50	CDR1 -B-121A--	120	F, G, J, K, M	BP	50
CDR1 -B-1R7A---	1.7	B, C, D	BG, BP	50	CDR1 -B-131A--	130	F, G, J, K, M	BP	50
CDR1 -B-1R8A---	1.8	B, C, D	BG, BP	50	CDR1 -B-151A--	150	F, G, J, K, M	BP	50
CDR1 -B-1R9A---	1.9	B, C, D	BG, BP	50	CDR1 -B-161A--	160	F, G, J, K, M	BP	50
CDR1 -B-2R0A---	2.0	B, C, D	BG, BP	50	CDR1 -B-181A--	180	F, G, J, K, M	BP	50
CDR1 -B-2R1A---	2.1	B, C, D	BG, BP	50	CDR1 -B-201A--	200	F, G, J, K, M	BP	50
CDR1 -B-2R2A---	2.2	B, C, D	BG, BP	50	CDR1 -B-221A--	220	F, G, J, K, M	BP	50
CDR1 -B-2R4A---	2.4	B, C, D	BG, BP	50	CDR1 -B-241A--	240	F, G, J, K, M	BP	50
CDR1 -B-2R7A---	2.7	B, C, D	BG, BP	50	CDR1 -B-271A--	270	F, G, J, K, M	BP	50
CDR1 -B-3R0A---	3.0	B, C, D	BG, BP	50	CDR1 -B-301A--	300	F, G, J, K, M	BP	50
CDR1 -B-3R3A---	3.3	B, C, D	BG, BP	50	CDR1 -B-331A--	330	F, G, J, K, M	BP	50
CDR1 -B-3R6A---	3.6	B, C, D	BG, BP	50	CDR1 -B-361A--	360	F, G, J, K, M	BP	50
CDR1 -B-3R9A---	3.9	B, C, D	BG, BP	50	CDR1 -B-391A--	390	F, G, J, K, M	BP	50
CDR1 -B-4R3A---	4.3	B, C, D	BG, BP	50	CDR1 -B-431A--	430	F, G, J, K, M	BP	50
CDR1 -B-4R7A---	4.7	B, C, D	BG, BP	50	CDR1 -B-471A--	470	F, G, J, K, M	BP	50
CDR1 -B-5R1A---	5.1	B, C, D	BG, BP	50	CDR1 -B-511A--	510	F, G, J, K, M	BP	50
CDR1 -B-5R6A---	5.6	B, C, D	BG, BP	50	CDR1 -B-561A--	560	F, G, J, K, M	BP	50
CDR1 -B-6R2A---	6.2	B, C, D	BG, BP	50	CDR1 -B-621A--	620	F, G, J, K, M	BP	50
CDR1 -B-6R8A---	6.8	B, C, J, K, M	BG, BP	50	CDR1 -B-681A--	680	F, G, J, K, M	BP	50
CDR1 -B-7R5A---	7.5	B, C, J, K, M	BG, BP	50	CDR1 -B-751A--	750	F, G, J, K, M	BP	50
CDR1 -B-8R2A---	8.2	B, C, J, K, M	BG, BP	50	CDR1 -B-821A--	820	F, G, J, K, M	BP	50
CDR1 -B-9R1A---	9.1	B, C, J, K, M	BG, BP	50	CDR1 -B-911A--	910	F, G, J, K, M	BP	50
CDR1 -B-100A--	10	F, G, J, K, M	BG, BP	50	CDR1 -B-102A--	1000	F, G, J, K, M	BP	50
CDR1 -B-110A--	11	F, G, J, K, M	BG, BP	50					
CDR1 -B-120A--	12	F, G, J, K, M	BG, BP	50					
CDR1 -B-130A--	13	F, G, J, K, M	BG, BP	50					
CDR1 -B-150A--	15	F, G, J, K, M	BG, BP	50					
CDR1 -B-160A--	16	F, G, J, K, M	BG, BP	50					
CDR1 -B-180A--	18	F, G, J, K, M	BG, BP	50					
CDR1 -B-200A--	20	F, G, J, K, M	BG, BP	50					
CDR1 -B-220A--	22	F, G, J, K, M	BG, BP	50					
CDR1 -B-240A--	24	F, G, J, K, M	BG, BP	50					
CDR1 -B-270A--	27	F, G, J, K, M	BG, BP	50					

1/Complete type designation will include additional symbols to indicate style, voltage-temperature limits, capacitance tolerance (where applicable), termination finish ("M" or "N" for style CDR11, and "S", "U" or "W" for style CDR12) and failure rate level.

# Microwave MLC's



## CDR Series — MIL-PRF-55681 (RF/Microwave Chips)

**TABLE II: STYLES CDR13 AND CDR14 CAPACITOR CHARACTERISTICS**

Type Designation 1/	Capacitance in pF	Capacitance tolerance	Rated temperature and V/Temperature	WVDC	Type Designation 1/	Capacitance in pF	Capacitance tolerance	Rated temperature and V/Temperature	WVDC
CDR1 -B-0R1*B--	0.1	B	BG, BP	200/500	CDR1 -B-560*---	56	F, G, J, K, M	BG, BP	200/500
CDR1 -B-0R2*B--	0.2	B	BG, BP	200/500	CDR1 -B-620*---	62	F, G, J, K, M	BG, BP	200/500
CDR1 -B-0R3*---	0.3	B, C	BG, BP	200/500	CDR1 -B-680*---	68	F, G, J, K, M	BG, BP	200/500
CDR1 -B-0R4*---	0.4	B, C	BG, BP	200/500	CDR1 -B-750*---	75	F, G, J, K, M	BG, BP	200/500
CDR1 -B-0R5*---	0.5	B, C, D	BG, BP	200/500	CDR1 -B-820*---	82	F, G, J, K, M	BG, BP	200/500
CDR1 -B-0R6*---	0.6	B, C, D	BG, BP	200/500	CDR1 -B-910*---	91	F, G, J, K, M	BG, BP	200/500
CDR1 -B-0R7*---	0.7	B, C, D	BG, BP	200/500	CDR1 -B-101*---	100	F, G, J, K, M	BG, BP	200/500
CDR1 -B-0R8*---	0.8	B, C, D	BG, BP	200/500	CDR1 -B-111*---	110	F, G, J, K, M	BG, BP	200/300
CDR1 -B-0R9*---	0.9	B, C, D	BG, BP	200/500	CDR1 -B-121*---	120	F, G, J, K, M	BG, BP	200/300
CDR1 -B-1R0*---	1.0	B, C, D	BG, BP	200/500	CDR1 -B-131*---	130	F, G, J, K, M	BG, BP	200/300
CDR1 -B-1R1*---	1.1	B, C, D	BG, BP	200/500	CDR1 -B-151*---	150	F, G, J, K, M	BG, BP	200/300
CDR1 -B-1R2*---	1.2	B, C, D	BG, BP	200/500	CDR1 -B-161*---	160	F, G, J, K, M	BG, BP	200/300
CDR1 -B-1R3*---	1.3	B, C, D	BG, BP	200/500	CDR1 -B-181*---	180	F, G, J, K, M	BG, BP	200/300
CDR1 -B-1R4*---	1.4	B, C, D	BG, BP	200/500	CDR1 -B-201*---	200	F, G, J, K, M	BG, BP	200/300
CDR1 -B-1R5*---	1.5	B, C, D	BG, BP	200/500	CDR1 -B-221C---	220	F, G, J, K, M	BG, BP	200
CDR1 -B-1R6*---	1.6	B, C, D	BG, BP	200/500	CDR1 -B-241C---	240	F, G, J, K, M	BG, BP	200
CDR1 -B-1R7*---	1.7	B, C, D	BG, BP	200/500	CDR1 -B-271C---	270	F, G, J, K, M	BG, BP	200
CDR1 -B-1R8*---	1.8	B, C, D	BG, BP	200/500	CDR1 -B-301C---	300	F, G, J, K, M	BG, BP	200
CDR1 -B-1R9*---	1.9	B, C, D	BG, BP	200/500	CDR1 -B-331C---	330	F, G, J, K, M	BG, BP	200
CDR1 -B-2R0*---	2.0	B, C, D	BG, BP	200/500	CDR1 -B-361C---	360	F, G, J, K, M	BG, BP	200
CDR1 -B-2R1*---	2.1	B, C, D	BG, BP	200/500	CDR1 -B-391C---	390	F, G, J, K, M	BG, BP	200
CDR1 -B-2R2*---	2.2	B, C, D	BG, BP	200/500	CDR1 -B-431C---	430	F, G, J, K, M	BG, BP	200
CDR1 -B-2R4*---	2.4	B, C, D	BG, BP	200/500	CDR1 -B-471C---	470	F, G, J, K, M	BG, BP	200
CDR1 -B-2R7*---	2.7	B, C, D	BG, BP	200/500	CDR1 -B-511B---	510	F, G, J, K, M	BG, BP	100
CDR1 -B-3R0*---	3.0	B, C, D	BG, BP	200/500	CDR1 -B-561B---	560	F, G, J, K, M	BG, BP	100
CDR1 -B-3R3*---	3.3	B, C, D	BG, BP	200/500	CDR1 -B-621B---	620	F, G, J, K, M	BG, BP	100
CDR1 -B-3R6*---	3.6	B, C, D	BG, BP	200/500	CDR1 -B-681A---	680	F, G, J, K, M	BG, BP	50
CDR1 -B-3R9*---	3.9	B, C, D	BG, BP	200/500	CDR1 -B-751A---	750	F, G, J, K, M	BG, BP	50
CDR1 -B-4R3*---	4.3	B, C, D	BG, BP	200/500	CDR1 -B-821A---	820	F, G, J, K, M	BG, BP	50
CDR1 -B-4R7*---	4.7	B, C, D	BG, BP	200/500	CDR1 -B-911A---	910	F, G, J, K, M	BG, BP	50
CDR1 -B-5R1*---	5.1	B, C, D	BG, BP	200/500	CDR1 -B-102A---	1000	F, G, J, K, M	BG, BP	50
CDR1 -B-5R6*---	5.6	B, C, D	BG, BP	200/500	CDR1 -B-112A---	1100	F, G, J, K, M	BP	50
CDR1 -B-6R2*---	6.2	B, C, D	BG, BP	200/500	CDR1 -B-122A---	1200	F, G, J, K, M	BP	50
CDR1 -B-6R8*---	6.8	B, C, J, K, M	BG, BP	200/500	CDR1 -B-132A---	1300	F, G, J, K, M	BP	50
CDR1 -B-7R5*---	7.5	B, C, J, K, M	BG, BP	200/500	CDR1 -B-152A---	1500	F, G, J, K, M	BP	50
CDR1 -B-8R2*---	8.2	B, C, J, K, M	BG, BP	200/500	CDR1 -B-162A---	1600	F, G, J, K, M	BP	50
CDR1 -B-9R1*---	9.1	B, C, J, K, M	BG, BP	200/500	CDR1 -B-182A---	1800	F, G, J, K, M	BP	50
CDR1 -B-100*---	10	F, G, J, K, M	BG, BP	200/500	CDR1 -B-202A---	2000	F, G, J, K, M	BP	50
CDR1 -B-110*---	11	F, G, J, K, M	BG, BP	200/500	CDR1 -B-222A---	2200	F, G, J, K, M	BP	50
CDR1 -B-120*---	12	F, G, J, K, M	BG, BP	200/500	CDR1 -B-242A---	2400	F, G, J, K, M	BP	50
CDR1 -B-130*---	13	F, G, J, K, M	BG, BP	200/500	CDR1 -B-272A---	2700	F, G, J, K, M	BP	50
CDR1 -B-150*---	15	F, G, J, K, M	BG, BP	200/500	CDR1 -B-302A---	3000	F, G, J, K, M	BP	50
CDR1 -B-160*---	16	F, G, J, K, M	BG, BP	200/500	CDR1 -B-332A---	3300	F, G, J, K, M	BP	50
CDR1 -B-180*---	18	F, G, J, K, M	BG, BP	200/500	CDR1 -B-362A---	3600	F, G, J, K, M	BP	50
CDR1 -B-200*---	20	F, G, J, K, M	BG, BP	200/500	CDR1 -B-392A---	3900	F, G, J, K, M	BP	50
CDR1 -B-220*---	22	F, G, J, K, M	BG, BP	200/500	CDR1 -B-432A---	4300	F, G, J, K, M	BP	50
CDR1 -B-240*---	24	F, G, J, K, M	BG, BP	200/500	CDR1 -B-472A---	4700	F, G, J, K, M	BP	50
CDR1 -B-270*---	27	F, G, J, K, M	BG, BP	200/500	CDR1 -B-502A---	5000	F, G, J, K, M	BP	50
CDR1 -B-300*---	30	F, G, J, K, M	BG, BP	200/500	CDR1 -B-512A---	5100	F, G, J, K, M	BP	50
CDR1 -B-330*---	33	F, G, J, K, M	BG, BP	200/500					
CDR1 -B-360*---	36	F, G, J, K, M	BG, BP	200/500					
CDR1 -B-390*---	39	F, G, J, K, M	BG, BP	200/500					
CDR1 -B-430*---	43	F, G, J, K, M	BG, BP	200/500					
CDR1 -B-470*---	47	F, G, J, K, M	BG, BP	200/500					
CDR1 -B-510*---	51	F, G, J, K, M	BG, BP	200/500					

1/Complete type designation will include additional symbols to indicate style, voltage-temperature limits, capacitance tolerance (where applicable), termination finish ("M" or "N" for style CDR13, and "S", "U" or "W" for style CDR14) and failure rate level.

\*C=200V; E=500V.

‡C=200V; D=300V.

6



**TYPICAL Q vs. FREQUENCY**  
AQ11/12  
MIL-PRF-55681E - BG  
STANDARD - M

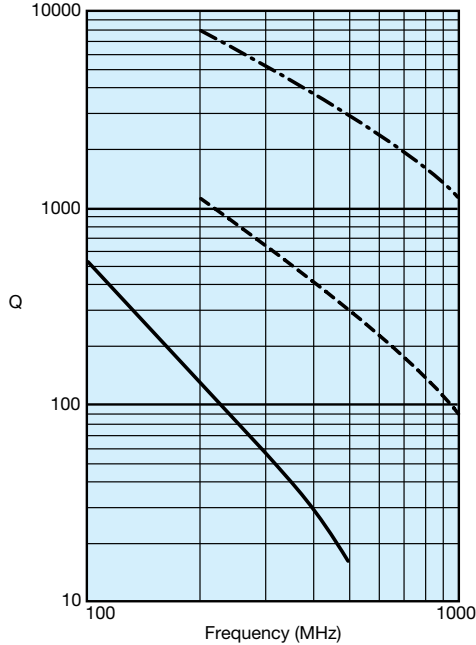

AVX CORPORATION  
 - - - 1 Picofarad    - - - 10 Picofarad    — 100 Picofarad

**TYPICAL ESR vs. FREQUENCY**  
AQ11/12  
MIL-PRF-55681E - BG  
STANDARD - M

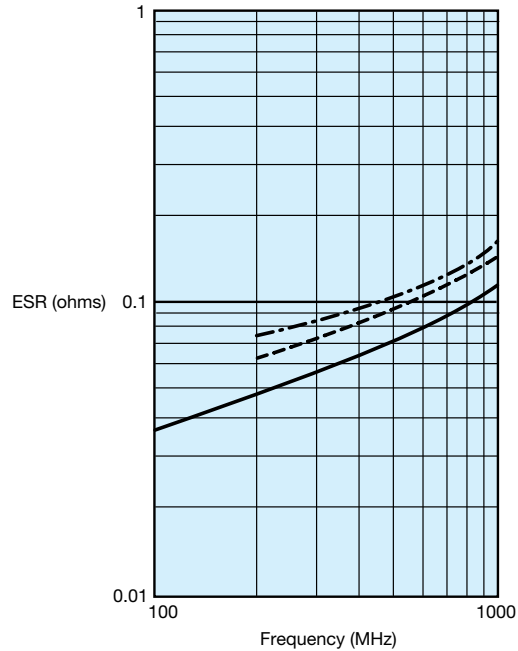

AVX CORPORATION  
 - - - 3.3 Picofarad    - - - 10 Picofarad    — 100 Picofarad

**TYPICAL Q vs. CAPACITANCE**  
AQ11/12  
MIL-PRF-55681E - BG  
STANDARD - M

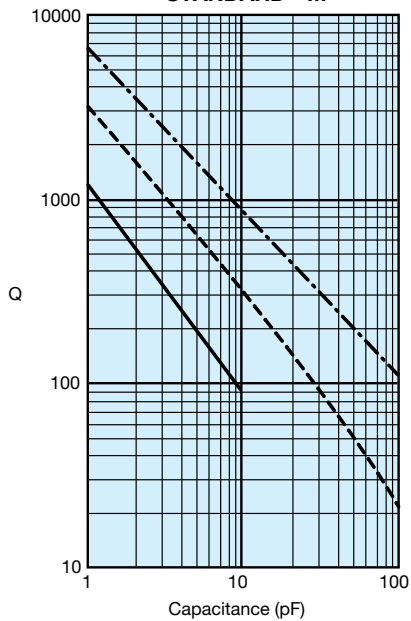

AVX CORPORATION  
 - - - 250 MHz    - - - 500 MHz    — 1000 MHz

**TYPICAL ESR vs. CAPACITANCE**  
AQ11/12  
MIL-PRF-55681E - BG  
STANDARD - M

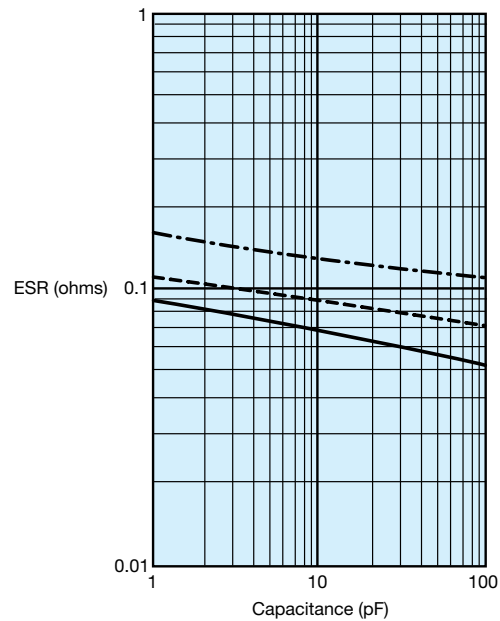

AVX CORPORATION  
 — 250 MHz    - - - 500 MHz    - - - 1000 MHz

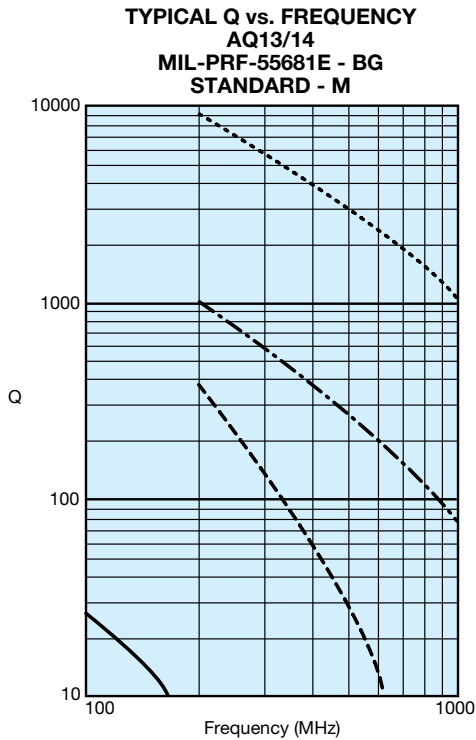

AVX CORPORATION  
 - - - - 1 Picofarad   - - - - 10 Picofarad   - - - - 47 Picofarad   - - - - 330 Picofarad

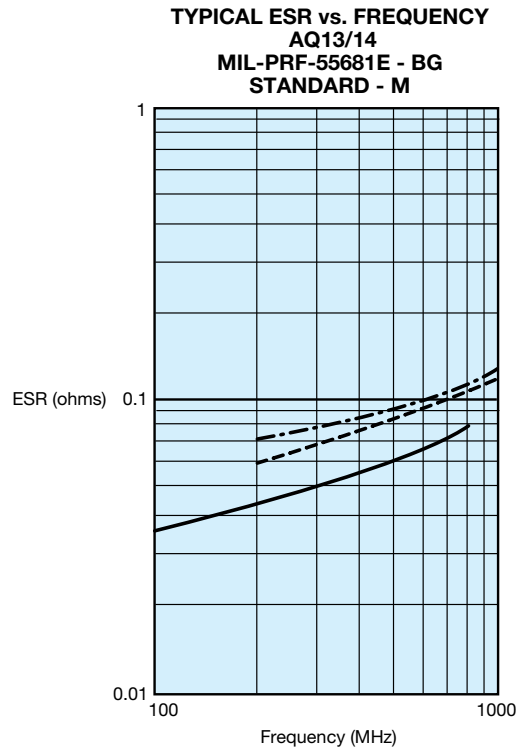

AVX CORPORATION  
 - - - - 1 Picofarad   - - - - 15 Picofarad   - - - - 100 Picofarad

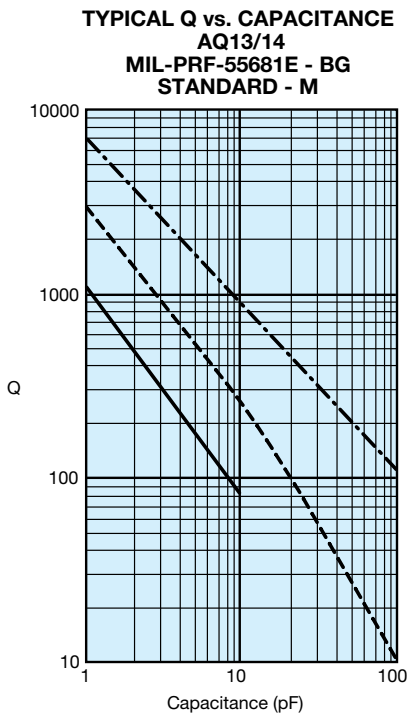

AVX CORPORATION  
 - - - - 250 MHz   - - - - 500 MHz   - - - - 1000 MHz

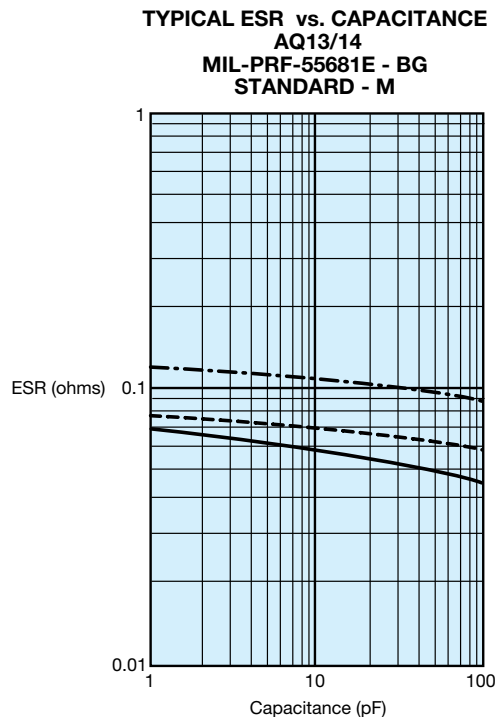

AVX CORPORATION  
 - - - - 250 MHz   - - - - 500 MHz   - - - - 1000 MHz

**TYPICAL Q vs. FREQUENCY**  
AQ11/12  
MIL-PRF-55681E - BP  
STANDARD - A

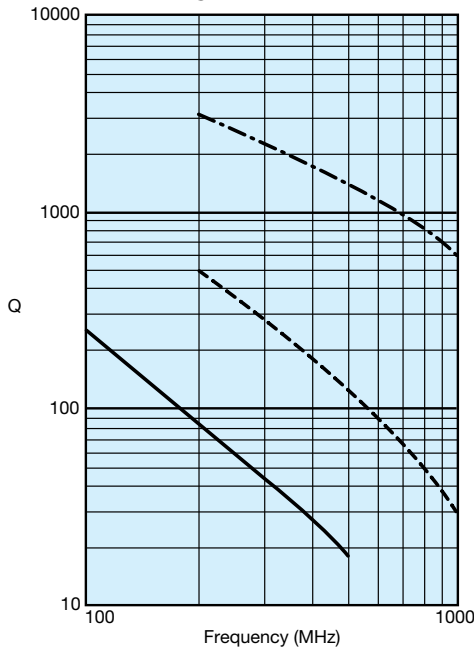

AVX CORPORATION  
- - - 1 Picofarad   - - - 15 Picofarad   — 100 Picofarad

**TYPICAL ESR vs. FREQUENCY**  
AQ11/12  
MIL-PRF-55681E - BP  
STANDARD - A

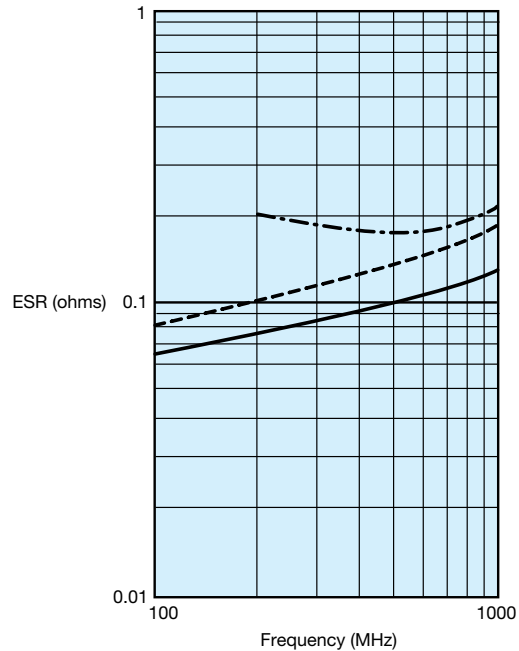

AVX CORPORATION  
- - - 1 Picofarad   - - - 15 Picofarad   — 100 Picofarad

**TYPICAL Q vs. CAPACITANCE**  
AQ11/12  
MIL-PRF-55681E - BP  
STANDARD - A

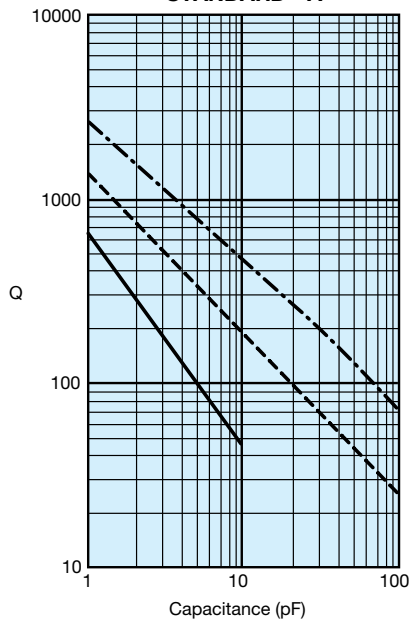

AVX CORPORATION  
- - - 250 MHz   - - - 500 MHz   — 1000 MHz

**TYPICAL ESR vs. CAPACITANCE**  
AQ11/12  
MIL-PRF-55681E - BP  
STANDARD - A

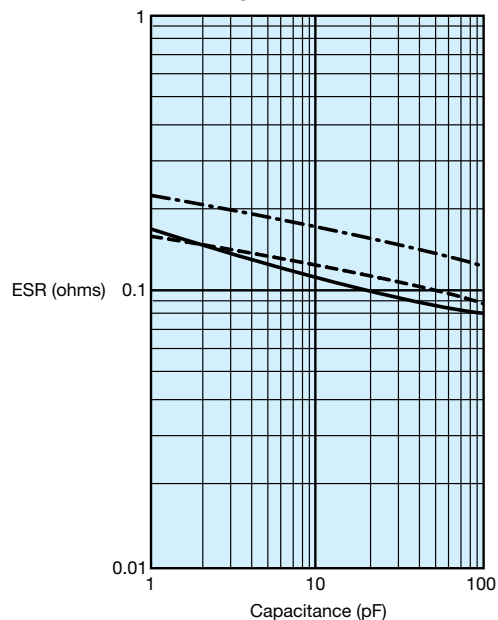

AVX CORPORATION  
— 250 MHz   - - - 500 MHz   - - - 1000 MHz

**TYPICAL Q vs. FREQUENCY**  
AQ13/14  
MIL-PRF-55681E - BP  
STANDARD - A

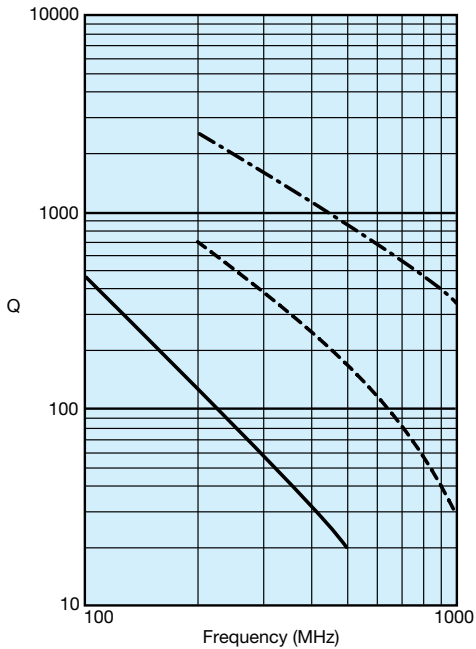

AVX CORPORATION  
--- 2 Picofarad    - - - 15 Picofarad    — 100 Picofarad

**TYPICAL ESR vs. FREQUENCY**  
AQ13/14  
MIL-PRF-55681E - BP  
STANDARD - A

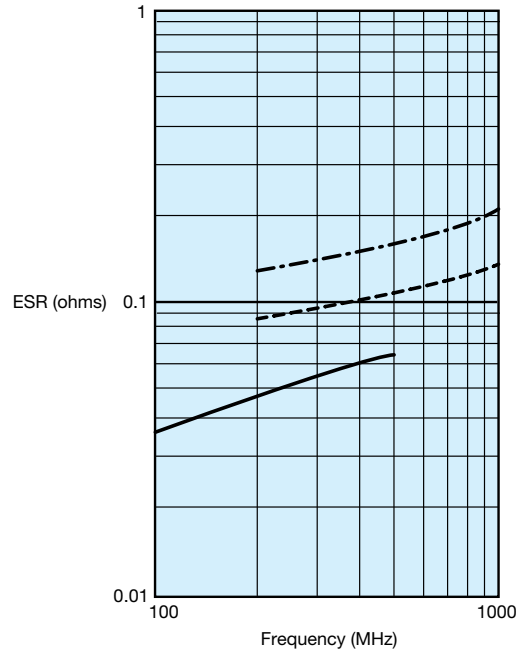

AVX CORPORATION  
--- 15 Picofarad    - - - 47 Picofarad    — 100 Picofarad

**TYPICAL Q vs. CAPACITANCE**  
AQ13/14  
MIL-PRF-55681E - BP  
STANDARD - A

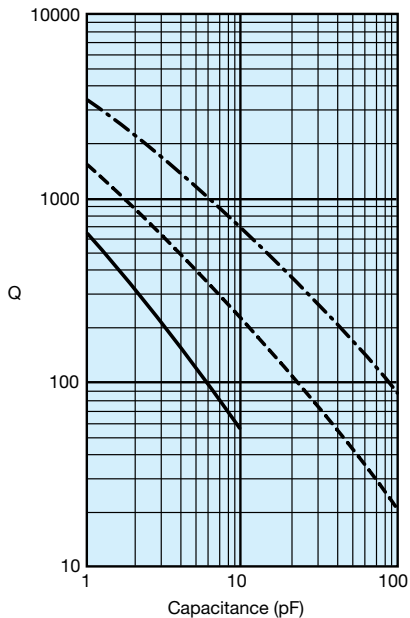

AVX CORPORATION  
--- 250 MHz    - - - 500 MHz    — 1000 MHz

**TYPICAL ESR vs. CAPACITANCE**  
AQ13/14  
MIL-PRF-55681E - BP  
STANDARD - A

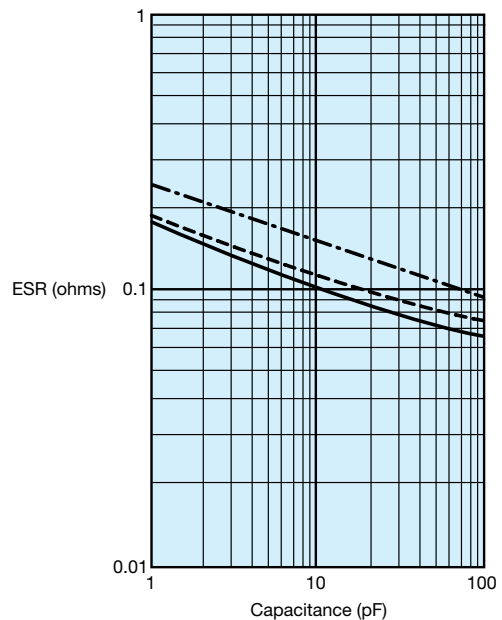

AVX CORPORATION  
--- 250 MHz    - - - 500 MHz    — 1000 MHz

**TYPICAL RESONANT FREQUENCY vs. CAPACITANCE  
AVX AQ11-14 (CDR11-14)**

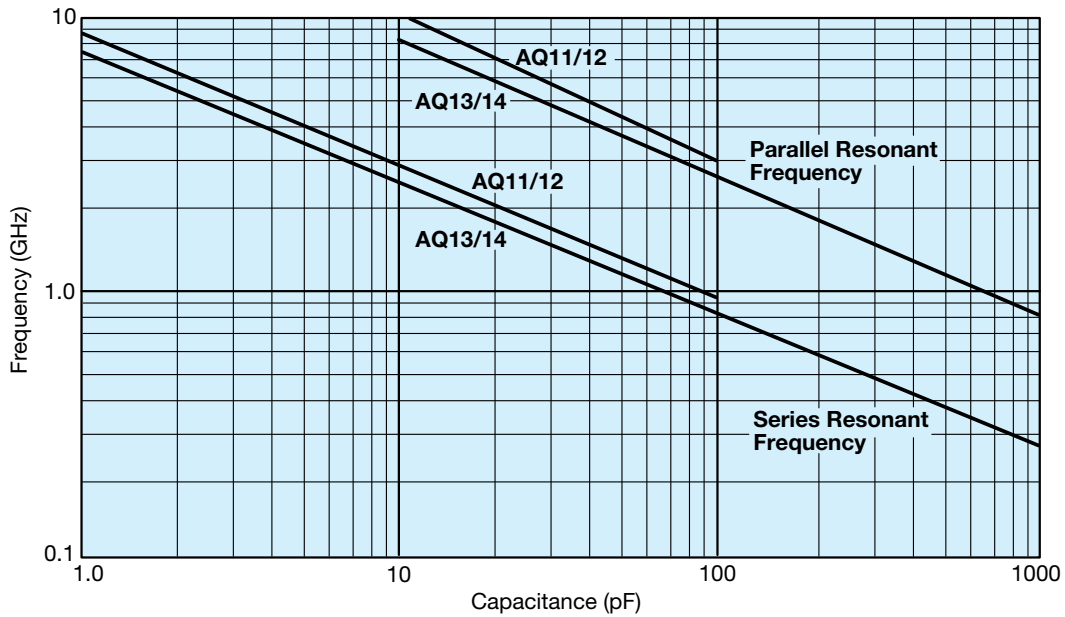

**TYPICAL RESONANT FREQUENCY vs. CAPACITANCE  
AVX 0603**

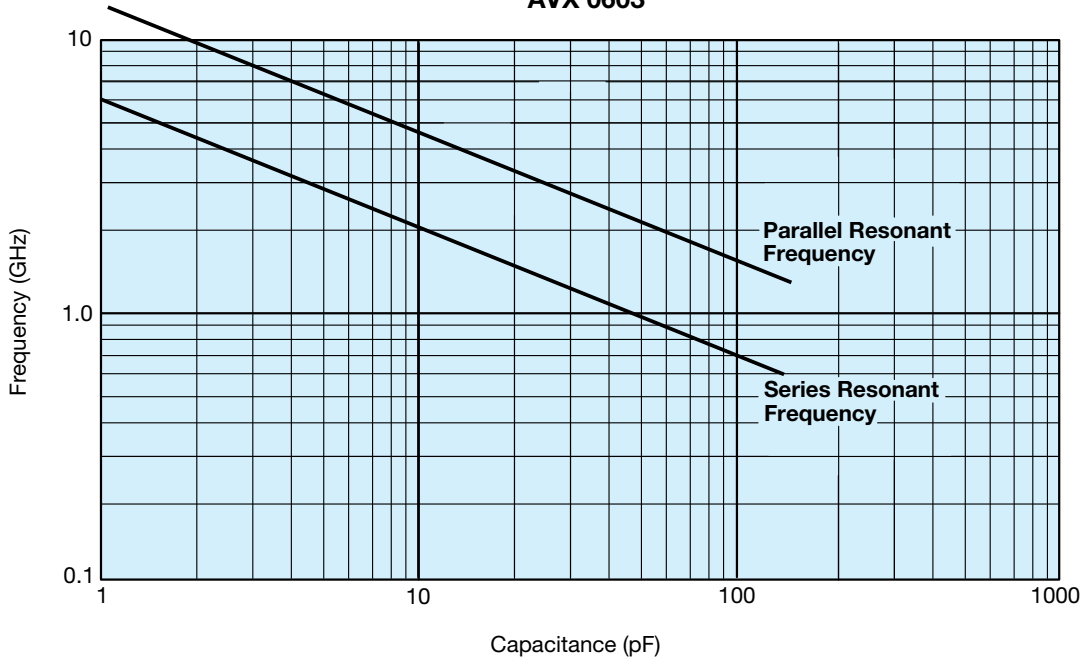



# Microwave MLC's

## Automatic Insertion Packaging



**TAPE & REEL:** All tape and reel specifications are in compliance with EIA RS481 (equivalent to IEC 286 part 3).

Sizes SQCA through SQCB, CDR11/12 through 13/14.

- 8mm carrier
- 7" reel:  $\leq 0.040$ " thickness = 2000 pcs  
 $\leq 0.075$ " thickness = 2000 pcs
- 13" reel:  $\leq 0.075$ " thickness = 10,000 pcs

"U" Series - 402/0603/0805/1210 Size Chips

- 8mm carrier
- 7" reel: 0402 = 10,000 pcs  
0603 & 0805  $\leq 0.40$ " thickness = 4000 pcs  
0805 . 0.040" thickness & 1210 = 2000 pcs
- 13" reel:  $\leq 0.075$ " thickness = 10,000 pcs

### REEL DIMENSIONS: millimeters (inches)

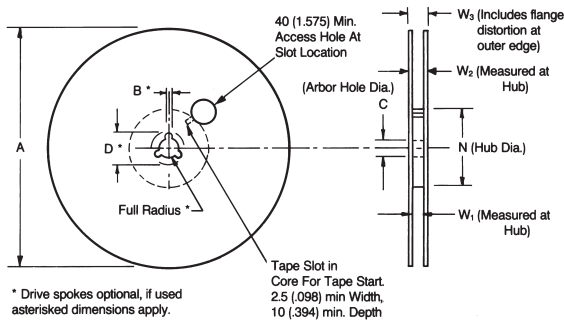

Tape Size <sup>(1)</sup>	A Max.	B* Min.	C	D* Min.	N Min.	W <sub>1</sub>	W <sub>2</sub> Max.	W <sub>3</sub>
8mm	330 (12.992)	1.5 (.059)	13.0±0.20 (.512±.008)	20.2 (.795)	50 (1.969)	8.4 <sup>+1.0</sup> / <sub>-0.0</sub> (.331 <sup>+0.060</sup> / <sub>-0.0</sub> )	14.4 (.567)	7.9 Min. (.311) 10.9 Max. (.429)
12mm						12.4 <sup>+2.0</sup> / <sub>-0.0</sub> (.488 <sup>+0.075</sup> / <sub>-0.0</sub> )	18.4 (.724)	11.9 Min. (.469) 15.4 Max. (.607)

Metric dimensions will govern.  
English measurements rounded and for reference only.  
(1) For tape sizes 16mm and 24mm (used with chip size 3640) consult EIA RS-481 latest revision.

### EMBOSSED CARRIER CONFIGURATION

#### 8 & 12 MM TAPE ONLY

#### CONSTANT DIMENSIONS

Tape Size	D <sub>0</sub>	E	P <sub>0</sub>	P <sub>2</sub>	T Max.	T <sub>1</sub>	G <sub>1</sub>	G <sub>2</sub>
8mm and 12mm	8.4 <sup>+0.10</sup> / <sub>-0.0</sub> (.059 <sup>+0.004</sup> / <sub>-0.0</sub> )	1.75 ± 0.10 (.069 ± .004)	4.0 ± 0.10 (.157 ± .004)	2.0 ± 0.05 (.079 ± .002)	0.600 (.024)	0.10 Max. (.004)	0.75 Min. (.030)	0.75 Min. (.030)

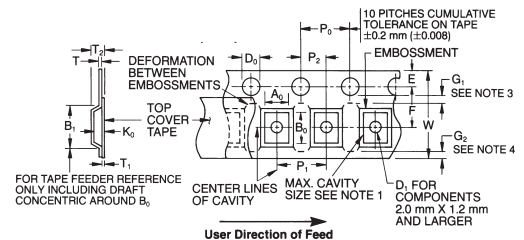

#### VARIABLE DIMENSIONS

Tape Size	B <sub>1</sub> Max. See Note 6	D <sub>1</sub> Min. See Note 5	F	P <sub>1</sub>	R Min. See Note 2	T <sub>2</sub>	W	A <sub>0</sub> B <sub>0</sub> K <sub>0</sub>
8mm	4.55 (.179)	1.0 (.039)	3.5 ± 0.05 (.138 ± .002)	4.0 ± 0.10 (.157 ± .004)	25 (.984)	2.5 Max (.098)	8.0 <sup>+0.3</sup> / <sub>-0.1</sub> (.315 <sup>+0.012</sup> / <sub>-0.004</sub> )	See Note 1
12mm	8.2 (.323)	1.5 (.059)	5.5 ± 0.05 (.217 ± .002)	4.0 ± 0.10 (.157 ± .004)	30 (1.181)	6.5 Max (.256)	12.0 ± .30 (.472 ± .012)	See Note 1

#### NOTES:

- A<sub>0</sub>, B<sub>0</sub>, and K<sub>0</sub> are determined by the max. dimensions to the ends of the terminals extending from the component body and/or the body dimensions of the component. The clearance between the end of the terminals or body of the component to the sides and depth of the cavity (A<sub>0</sub>, B<sub>0</sub>, and K<sub>0</sub>) must be within 0.05 mm (.002) min. and 0.50 mm (.020) max. The clearance allowed must also prevent rotation of the component within the cavity of not more than 20 degrees (see sketches C & D).
- Tape with components shall pass around radius "R" without damage. The minimum trailer length (Note 2 Fig. 3) may require additional length to provide R min. for 12mm embossed tape for reels with hub diameters approaching N min. (Table 4).
- G<sub>1</sub> dimension is the flat area from the edge of the sprocket hole to either the outward deformation of the carrier tape between the embossed cavities or to the edge of the cavity whichever is less.
- G<sub>2</sub> dimension is the flat area from the edge of the carrier tape opposite the sprocket holes to either the outward deformation of the carrier tape between the embossed cavity or to the edge of the cavity whichever is less.
- The embossment hole location shall be measured from the sprocket hole controlling the location of the embossment. Dimensions of embossment location and hole location shall be applied independent of each other.
- B<sub>1</sub> dimension is a reference dimension for tape feeder clearance only.

