

Aluminum Capacitors Axial Long-Life, DIN-Based

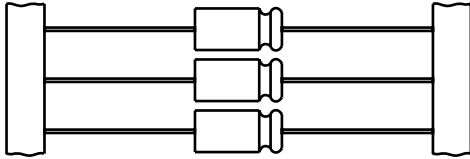
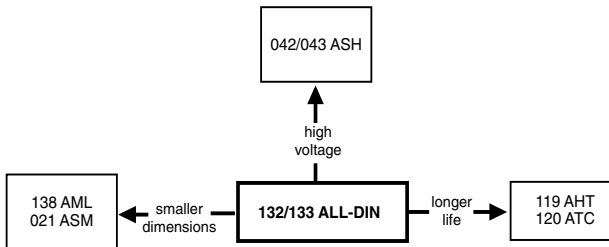

Fig.1 Component outlines



RoHS
COMPLIANT

FEATURES

- Polarized aluminum electrolytic capacitors, non-solid electrolyte
- Axial leads, cylindrical aluminum case, insulated with a blue sleeve
- Mounting ring version not available in insulated form
- Taped versions up to case Ø 15 mm x 30 mm available for automatic insertion
- Charge and discharge proof
- Long useful life: up to 10 000 hours to 15 000 hours at 85 °C, high reliability
- Compliant to RoHS directive 2002/95/EC

APPLICATIONS

- General industrial, power supplies, telecommunication, EDP
- Coupling, decoupling, timing; smoothing, filtering and buffering in SMPS
- For use where low mounting height is important
- Vibration and shock resistant

MARKING

The capacitors are marked (where possible) with the following information:

- Rated capacitance (in µF)
- Tolerance on rated capacitance, code letter in accordance with IEC 60062 (T for - 10 to + 50 %)
- Rated voltage (in V)
- Upper category temperature (85 °C)
- Date code, in accordance with IEC 60062
- Code for factory of origin
- Name of manufacturer
- Band to indicate the negative terminal
- '+' sign to identify the positive terminal
- Series number (132 or 133)

QUICK REFERENCE DATA			
DESCRIPTION	VALUE		
Nominal case sizes (Ø D x L in mm)	6.5 x 18 and 8 x 18	10 x 18 and 10 x 25	10 x 30 to 21 x 38
Rated capacitance range, C _R	1 µF to 4700 µF		
Tolerance on C _R	- 10 % to + 50 %		
Rated voltage range, U _R	10 V to 250 V		
Category temperature range	- 40 °C to + 85 °C		
Endurance test at 105 °C	2000 hours	2000 hours	-
Endurance test at 85 °C	6000 hours	8000 hours	8000 hours
Useful life at 105 °C	3000 hours	3000 hours	-
Useful life at 85 °C	10 000 hours	15 000 hours	15 000 hours
Useful life at 40 °C, 1.8 x I _R applied	160 000 hours	240 000 hours	240 000 hours
Shelf life at 0 V, 85 °C	500 hours		
Based on sectional specification	IEC 60384-4/EN130300		
Climatic category IEC 60068	40/085/56		

SELECTION CHART FOR C _R , U _R AND RELEVANT NOMINAL CASE SIZES (Ø D x L in mm)									
C _R (µF)	U _R (V)								
	10	16	25	40	63	100	160	250	
1.0	-	-	-	-	-	6.5 x 18	-	-	-
2.2	-	-	-	-	-	6.5 x 18	6.5 x 18	8 x 18	-
4.7	-	-	-	-	6.5 x 18	6.5 x 18	8 x 18	10 x 18	-
10	-	-	-	-	6.5 x 18	8 x 18	10 x 18	10 x 25	-
	-	-	-	-	-	-	-	10 x 30 ⁽¹⁾	-
22	-	-	6.5 x 18	-	8 x 18	10 x 18	10 x 25	12.5 x 30 ⁽¹⁾	-
	-	-	-	-	-	-	10 x 30 ⁽¹⁾	-	-

Note

⁽¹⁾ For these CV-values see datasheet 041 - 043 ASH.

SELECTION CHART FOR C_R , U_R AND RELEVANT NOMINAL CASE SIZES ($\varnothing D \times L$ in mm)								
C_R (μF)	U_R (V)							
	10	16	25	40	63	100	160	250
47	-	6.5 x 18	-	8 x 18	10 x 18	10 x 25	15 x 30 ⁽¹⁾	18 x 30 ⁽¹⁾
68	-	-	-	-	-	10 x 30	12.5 x 30	15 x 30 ⁽¹⁾
100	-	8 x 18	-	10 x 18	10 x 30	15 x 30	18 x 30 ⁽¹⁾	21 x 38 ⁽¹⁾
150	-	-	-	12.5 x 30	15 x 30	18 x 30	18 x 38 ⁽¹⁾	-
220	8 x 18	10 x 18	10 x 25	12.5 x 30	15 x 30	18 x 38	21 x 38 ⁽¹⁾	-
330	-	10 x 25	12.5 x 30	15 x 30	18 x 30	18 x 38	-	-
470	12.5 x 30	10 x 25	12.5 x 30	15 x 30	18 x 38	21 x 38	-	-
680	12.5 x 30	15 x 30	18 x 30	18 x 30	21 x 38	-	-	-
1000	15 x 30	15 x 30	18 x 30	18 x 38	21 x 38	-	-	-
1500	18 x 30	18 x 30	18 x 38	21 x 38	-	-	-	-
2200	18 x 30	18 x 38	21 x 38	21 x 38	-	-	-	-
3300	18 x 38	21 x 38	-	-	-	-	-	-
4700	21 x 38	21 x 38	-	-	-	-	-	-

Note

(1) For these CV-values see datasheet 041 - 043 ASH.

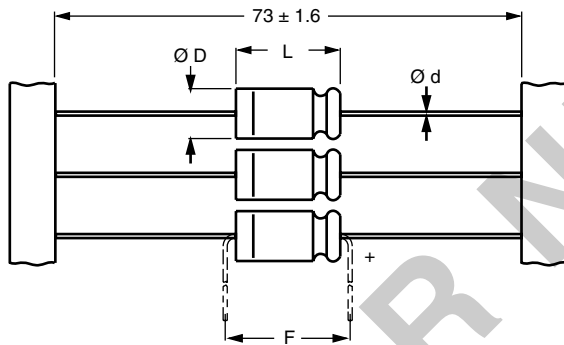
DIMENSIONS IN MILLIMETERS AND AVAILABLE FORMS

Form BR: Taped on reel
 case $\varnothing D \times L = 6.5 \text{ mm} \times 18 \text{ mm}$ to $15 \text{ mm} \times 30 \text{ mm}$
Form BA: Taped in box (ammopack)
 case $\varnothing D \times L = 6.5 \text{ mm} \times 18 \text{ mm}$ to $10 \text{ mm} \times 25 \text{ mm}$

Fig.3 Forms BA and BR

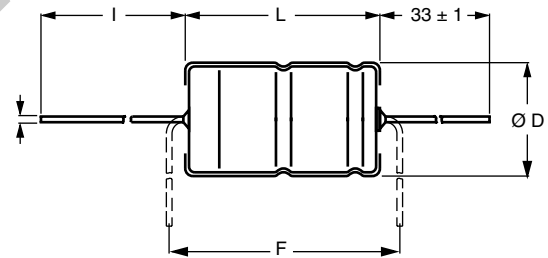

Form AA: Axial in box
 case $\varnothing D \times L = 10 \text{ mm} \times 30 \text{ mm}$ to $21 \text{ mm} \times 38 \text{ mm}$

Fig.3 Form AA

Table 1

AXIAL; DIMENSIONS in millimeters, MASS AND PACKAGING QUANTITIES										
NOMINAL CASE SIZE $\varnothing D \times L$	CASE CODE	AXIAL FORM AA, BA, and BR					MASS (g)	PACKAGING QUANTITIES		
		$\varnothing d$	l	$\varnothing D_{max.}$	$L_{max.}$	$F_{min.}$		FORM AA	FORM BA	FORM BR
6.5 x 18	4	0.8	-	6.9	18.5	25	≈ 1.3	-	1000	1000
8 x 18	5	0.8	-	8.5	18.5	25	≈ 1.7	-	500	500
10 x 18	6	0.8	-	10.5	18.5	25	≈ 2.5	-	500	500
10 x 25	7	0.8	-	10.5	25.5	30	≈ 3.3	-	500	500
10 x 30	00	0.8	55 ± 1	10.5	30.5	35	≈ 4.8	340	-	500
12.5 x 30	01	0.8	55 ± 1	13.0	30.5	35	≈ 7.4	260	-	400
15 x 30	02	0.8	55 ± 1	15.5	30.5	35	≈ 11.7	200	-	250
18 x 30	03	0.8	55 ± 1	18.5	30.5	35	≈ 12.9	120	-	-
18 x 38	04	0.8	34 ± 1	18.5	39.5	44	≈ 19.0	125	-	-
21 x 38	05	0.8	34 ± 1	21.5	39.5	44	≈ 24.0	100	-	-

Note

• Detailed tape dimensions see section 'PACKAGING'.

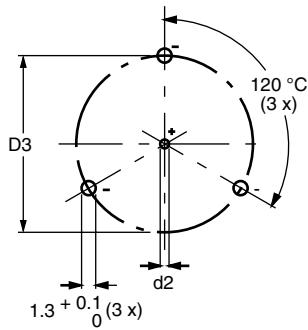

Mounting holes

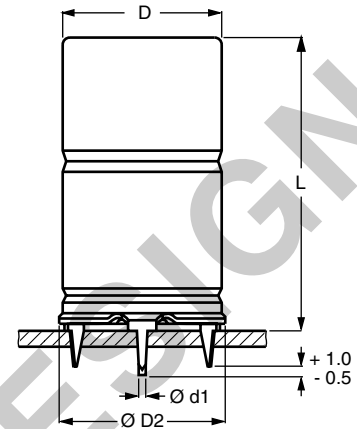
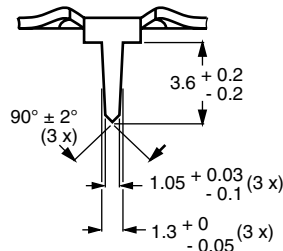

Case $\varnothing D \times L = 15 \text{ mm} \times 30 \text{ mm}$ to $21 \text{ mm} \times 38 \text{ mm}$

Case not insulated (insulation on request)

Especially for applications with severe shocks and vibrations

Fig.5 Mounting hole diagram and outline; **Form MR:** With mounting ring and pins

Table 2

MOUNTING RING; DIMENSIONS in millimeters, MASS AND PACKAGING QUANTITIES									
NOMINAL CASE SIZE $\varnothing D \times L$	CASE CODE	MOUNTING RING: FORM MR						MASS (g)	PACKAGING QUANTITIES
		$\varnothing d1$	$\varnothing d2$	$\varnothing D_{max.}$	$\varnothing D2_{max.}$	D3	L _{max.}		
15 x 30	02	0.8	1.0 + 0.4	15.5	17.5	16.5 ± 0.2	33	≈ 11.7	200
18 x 30	03	0.8	1.0 + 0.4	18.5	19.5	18.5 ± 0.2	33	≈ 12.9	240
18 x 38	04	0.8	1.0 + 0.4	18.5	19.5	18.5 ± 0.2	42	≈ 19.0	100
21 x 38	05	0.8	1.0 + 0.4	21.5	22.5	21.5 ± 0.2	42	≈ 24.0	100

ELECTRICAL DATA	
SYMBOL	DESCRIPTION
C_R	rated capacitance at 100 Hz, tolerance - 10 %/+ 50 %
I_R	rated RMS ripple current at 100 Hz, 85 °C
I_{L5}	max. leakage current after 5 minutes at U_R
$\tan \delta$	max. dissipation factor at 100 Hz
ESR	equivalent series resistance at 100 Hz (calculated from $\tan \delta_{max.}$ and C_R)
Z	max. impedance at 10 kHz

Note

Unless otherwise specified, all electrical values in Table 3 apply at $T_{amb} = 20 \text{ °C}$, $P = 86 \text{ kPa}$ to 106 kPa , $RH = 45 \text{ \%}$ to 75 \% .

ORDERING EXAMPLE

Electrolytic capacitor 132 series

100 $\mu\text{F}/40 \text{ V}$; - 10 %/+ 50 %

Nominal case size: $\varnothing 10 \text{ mm} \times 18 \text{ mm}$; Form BR

Ordering code: MAL213227101E3

Former 12NC: 2222 132 27101



Table 3

ELECTRICAL DATA AND ORDERING INFORMATION													
U _R (V)	C _R 100 Hz (μF)	NOMINAL CASE SIZE Ø D x L (mm)	I _R 100 Hz 85 °C (mA)	I _{L5} 5 min (μA)	tan δ 100 Hz	ESR 100 Hz (Ω)	Z 10 kHz (Ω)	Z 100 kHz (Ω)	ORDERING CODE MAL2.....				
									IN BOX FORM AA	TAPED ON REEL FORM BR	TAPED IN BOX FORM BA	MOUNTING RING FORM MR	
10	220	8 x 18	190	8.4	0.18	1.3	0.73	0.70	-	13224221E3	13234221E3	-	-
	470	12.5 x 30	350	9.4	0.18	0.61	0.26	0.60	13214471E3	13224471E3	-	-	
	680	12.5 x 30	460	13.6	0.18	0.42	0.20	0.40	13214681E3	13224681E3	-	-	
	1000	15 x 30	640	20	0.18	0.28	0.12	-	13214102E3	13224102E3	-	13244102E3	
	1500	18 x 30	800	30	0.22	0.23	0.10	-	13214152E3	-	-	13244152E3	
	2200	18 x 30	1100	44	0.22	0.16	0.09	-	13214222E3	-	-	13244222E3	
	3300	18 x 38	1300	66	0.27	0.13	0.05	-	13214332E3	-	-	13244332E3	
	4700	21 x 38	1800	94	0.27	0.09	0.05	-	13214472E3	-	-	13244472E3	
16	47	6.5 x 18	95	5.5	0.14	4.7	2.6	2.2	-	13225479E3	13235479E3	-	-
	100	8 x 18	150	7.2	0.14	2.2	1.2	1.1	-	13225101E3	13235101E3	-	-
	220	10 x 18	250	11	0.14	1.0	0.55	0.55	-	13225221E3	13235221E3	-	-
	330	10 x 25	320	14.6	0.14	0.67	0.36	0.36	-	13290508E3	13290509E3	-	-
	330	12.5 x 30	320	10.6	0.14	0.67	0.36	0.60	13215331E3	13225331E3	-	-	
	470	10 x 25	450	19	0.14	0.47	0.26	0.26	-	13290507E3	13290502E3	-	-
	470	12.5 x 30	450	15	0.14	0.47	0.26	0.40	13215471E3	13225471E3	-	-	
	680	15 x 30	550	22	0.14	0.33	0.14	-	13215681E3	13225681E3	-	13245681E3	
	1000	15 x 30	780	32	0.14	0.22	0.12	-	13215102E3	13225102E3	-	13245102E3	
	1500	18 x 30	950	48	0.15	0.16	0.10	-	13215152E3	-	-	13245152E3	
	2200	18 x 38	1300	70	0.15	0.11	0.06	-	13215222E3	-	-	13245222E3	
	3300	21 x 38	1600	110	0.15	0.07	0.05	-	13215332E3	-	-	13245332E3	
4700	21 x 38	2300	150	0.15	0.05	0.05	-	13215472E3	-	-	13245472E3		
25	22	6.5 x 18	60	5.1	0.11	8.0	4.1	2.9	-	13226229E3	13236229E3	-	-
	220	10 x 25	340	15	0.11	0.8	0.40	0.40	-	13290503E3	13290504E3	-	-
	220	12.5 x 30	340	11	0.11	0.8	0.40	0.60	13216221E3	13226221E3	-	-	
	330	12.5 x 30	410	16.5	0.11	0.53	0.30	0.40	13216331E3	13226331E3	-	-	
	470	12.5 x 30	560	24	0.11	0.37	0.20	-	13216471E3	13226471E3	-	-	
	680	18 x 30	700	34	0.11	0.26	0.10	-	13216681E3	-	-	13246681E3	
	1000	18 x 30	1000	50	0.11	0.17	0.10	-	13216102E3	-	-	13246102E3	
	1500	18 x 38	1100	75	0.12	0.13	0.06	-	13216152E3	-	-	13246152E3	
2200	21 x 38	1850	110	0.13	0.09	0.05	-	13216222E3	-	-	13246222E3		
40	47	8 x 18	120	7.8	0.09	3.0	1.6	1.4	-	13227479E3	13237479E3	-	-
	100	10 x 18	210	12	0.09	1.4	0.75	0.75	-	13227101E3	13237101E3	-	-
	150	10 x 25	310	16	0.09	0.95	0.50	0.50	-	13290511E3	13290512E3	-	-
	150	12.5 x 30	310	12	0.09	0.95	0.50	0.60	13217151E3	13227151E3	-	-	
	220	12.5 x 30	410	17.5	0.09	0.65	0.34	0.40	13217221E3	13227221E3	-	-	
	330	15 x 30	550	26	0.09	0.43	0.20	-	13217331E3	13227331E3	-	13247331E3	
	470	15 x 30	700	38	0.09	0.30	0.16	-	13217471E3	13227471E3	-	13247471E3	
	680	18 x 30	900	54	0.09	0.21	0.10	-	13217681E3	-	-	13247681E3	
	1000	18 x 38	1200	80	0.09	0.14	0.08	-	13217102E3	-	-	13247102E3	
	1500	21 x 38	1500	120	0.10	0.10	0.06	-	13217152E3	-	-	13247152E3	
2200	21 x 38	1900	180	0.10	0.07	0.05	-	13217222E3	-	-	13247222E3		
63	4.7	6.5 x 18	38	4.6	0.07	24	12	5	-	13228478E3	13238478E3	-	-
	10	6.5 x 18	64	5.3	0.07	11	5.5	3.3	-	13228109E3	13238109E3	-	-
	22	8 x 18	100	6.8	0.07	5.1	2.5	2.1	-	13228229E3	13238229E3	-	-
	47	10 x 18	170	9.9	0.07	2.4	1.2	1.2	-	13228479E3	13238479E3	-	-
	68	10 x 25	210	12.6	0.07	1.6	0.81	0.60	-	13290513E3	13290514E3	-	-
	68	10 x 30	210	8.6	0.07	1.6	0.80	0.60	13218689E3	13228689E3	-	-	
	100	10 x 30	300	12.6	0.07	1.1	0.60	0.40	13218101E3	13228101E3	-	-	
	150	15 x 30	350	19	0.07	0.74	0.37	-	13218151E3	13228151E3	-	13248151E3	
	220	15 x 30	520	28	0.07	0.50	0.25	-	13218221E3	13228221E3	-	13248221E3	
	330	18 x 30	600	42	0.07	0.34	0.15	-	13218331E3	-	-	13248331E3	
	470	18 x 38	970	59	0.07	0.24	0.12	-	13218471E3	-	-	13248471E3	
	680	21 x 38	1000	86	0.07	0.16	0.08	-	13218681E3	-	-	13248681E3	
1000	21 x 38	1600	130	0.07	0.11	0.06	-	13218102E3	-	-	13248102E3		

ELECTRICAL DATA AND ORDERING INFORMATION													
U _R (V)	C _R 100 Hz (μF)	NOMINAL CASE SIZE Ø D x L (mm)	I _R 100 Hz 85 °C (mA)	I _{L5} 5 min (μA)	tan δ 100 Hz	ESR 100 Hz (Ω)	Z 10 kHz (Ω)	Z 100 kHz (Ω)	ORDERING CODE MAL2.....				
									IN BOX FORM AA	TAPED ON REEL FORM BR	TAPED IN BOX FORM BA	MOUNTING RING FORM MR	
100	1	6.5 x 18	20	4.0	0.06	95	45	6	-	13229108E3	13239108E3	-	-
	2.2	6.5 x 18	30	4.4	0.06	43	20	5	-	13229228E3	13239228E3	-	-
	4.7	6.5 x 18	48	4.9	0.06	20	9.6	4	-	13229478E3	13239478E3	-	-
	10	8 x 18	73	6	0.06	9.5	4.5	2.8	-	13229109E3	13239109E3	-	-
	22	10 x 18	130	8.4	0.06	4.3	2	1.3	-	13229229E3	13239229E3	-	-
	47	10 x 25	220	13.4	0.06	2.0	1	0.90	-	13290505E3	13290506E3	-	-
	47	10 x 30	220	9.4	0.06	2.0	1	0.90	13219479E3	13229479E3	-	-	-
	68	12.5 x 30	250	13.5	0.06	1.4	0.80	-	13219689E3	13229689E3	-	-	-
	100	15 x 30	380	20	0.06	0.95	0.50	-	13219101E3	13229101E3	-	-	13249101E3
	150	18 x 30	400	30	0.06	0.64	0.35	-	13219151E3	-	-	-	13249151E3
	220	18 x 38	660	44	0.06	0.43	0.20	-	13219221E3	-	-	-	13249221E3
	330	18 x 38	700	66	0.06	0.29	0.15	-	13219331E3	-	-	-	13249331E3
470	21 x 38	1200	94	0.06	0.20	0.10	-	13219471E3	-	-	-	13249471E3	
160	2.2	6.5 x 18	22	20	0.10	72	55	30	-	13321228E3	13331228E3	-	-
	4.7	8 x 18	37	20	0.10	34	26	20	-	13321478E3	13331478E3	-	-
	10	10 x 18	61	20	0.10	16	12	10	-	13321109E3	13331109E3	-	-
	22	10 x 25	120	20	0.10	7.2	5.5	2.5	-	13390502E3	13390503E3	-	-
250	2.2	8 x 18	25	20	0.10	72	50	30	-	13323228E3	13333228E3	-	-
	4.7	10 x 18	37	20	0.10	34	23	16	-	13323478E3	13333478E3	-	-
	10	10 x 25	66	20	0.10	16	11	9	-	13323109E3	13333109E3	-	-

ADDITIONAL ELECTRICAL DATA			
PARAMETER	CONDITIONS	VALUE	
		AXIAL	MOUNTING RING
Voltage			
Surge voltage	U _R = 10 V to 250 V	U _s ≤ 1.15 x U _R	
Reverse voltage		U _{rev} ≤ 1 V	
Current			
Leakage current	After 1 minute:		
	Case Ø D x L = 6.5 mm x 18 mm to 10 mm x 25 mm:		
	U _R = 10 V to 100 V	I _{L1} ≤ 0.01 C _R x U _R + 3	
	U _R = 160 V to 250 V	I _{L1} ≤ 50 μA	
	Case Ø D x L = 10 mm x 30 mm to 21 mm x 38 mm:		
	U _R = 10 V to 100 V	I _{L1} ≤ 0.006 C _R x U _R + 3	
	After 5 minutes:		
	Case Ø D x L = 6.5 mm x 18 mm to 10 mm x 25 mm:		
	U _R = 10 V to 100 V	I _{L5} ≤ 0.002 C _R x U _R + 4	
	U _R = 160 V to 250 V	I _{L5} ≤ 20 μA	
Case Ø D x L = 10 mm x 30 mm to 21 mm x 38 mm:			
U _R = 10 V to 100 V	I _{L5} ≤ 0.002 C _R x U _R + 4 μA		
Inductance			
Equivalent series inductance (ESL)	Case Ø D x L mm:		
	6.5 x 18	typ. 15 nH	-
	8 x 18	typ. 35 nH	-
	10 x 18	typ. 69 nH	-
	10 x 25	typ. 38 nH	-
	10 x 30	typ. 38 nH	-
	12.5 x 30	typ. 46 nH	-
	15 x 30	typ. 48 nH	typ. 39 nH
	18 x 30	typ. 50 nH	typ. 39 nH
	18 x 38	typ. 54 nH	typ. 39 nH
21 x 38	typ. 59 nH	typ. 39 nH	

CAPACITANCE (C)

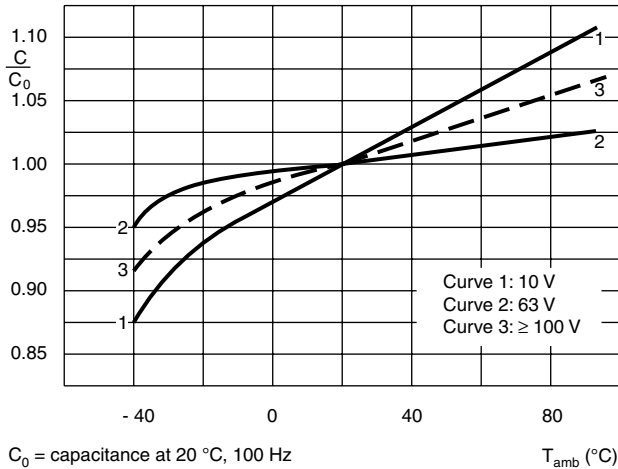

Fig.5 Typical multiplier of capacitance as a function of ambient temperature at 10 kHz

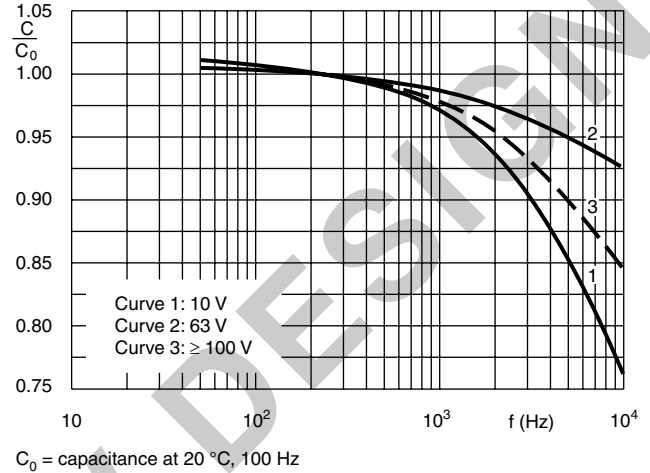

Fig.6 Typical multiplier of capacitance as a function of frequency

DISSIPATION FACTOR ($\tan \delta$)

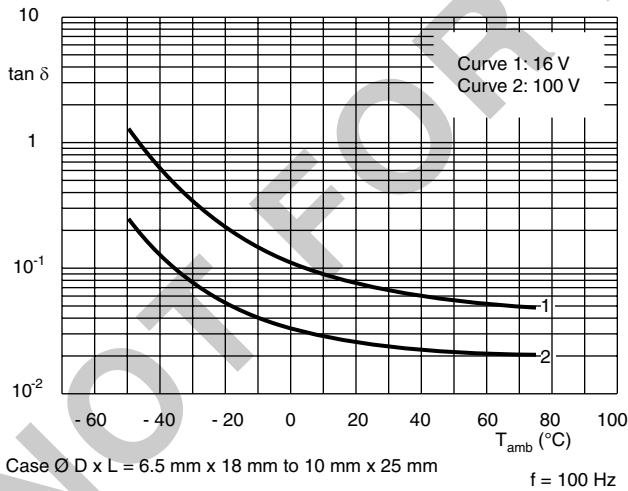

Fig.7 Typical $\tan \delta$ as a function of ambient temperature

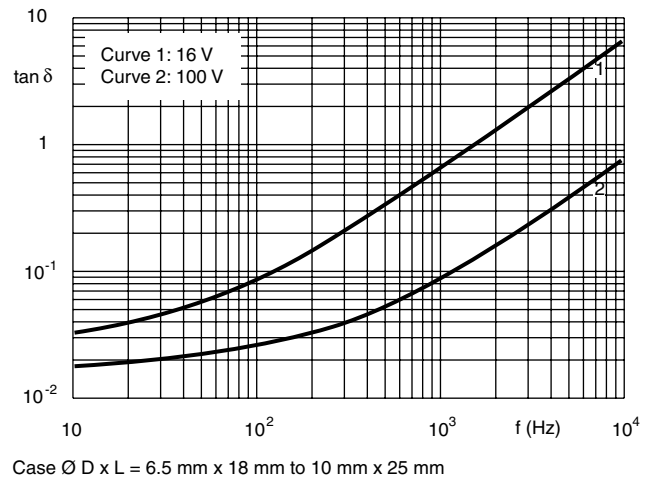

Fig.8 Typical $\tan \delta$ as a function of frequency

IMPEDANCE (Z)

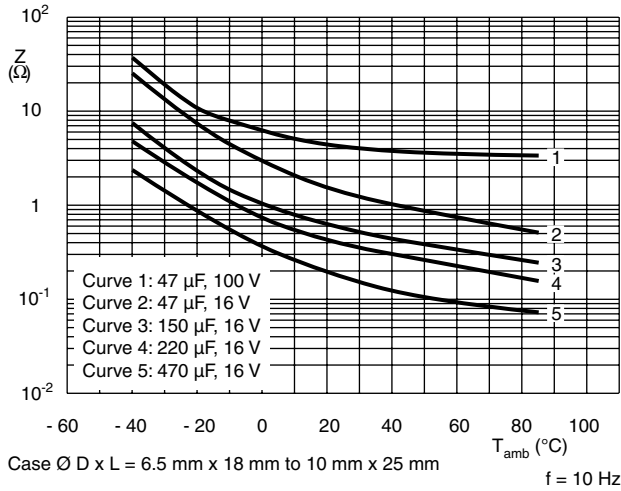

Fig.9 Typical impedance as a function of ambient temperature

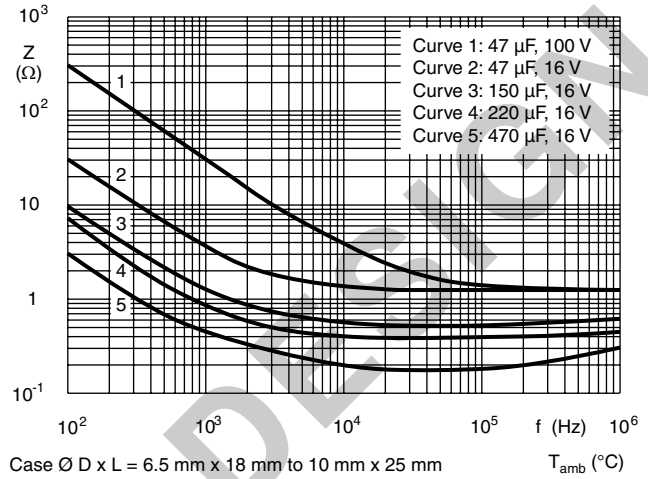

Fig.10 Typical impedance as a function of frequency

RIPPLE CURRENT AND USEFUL LIFE

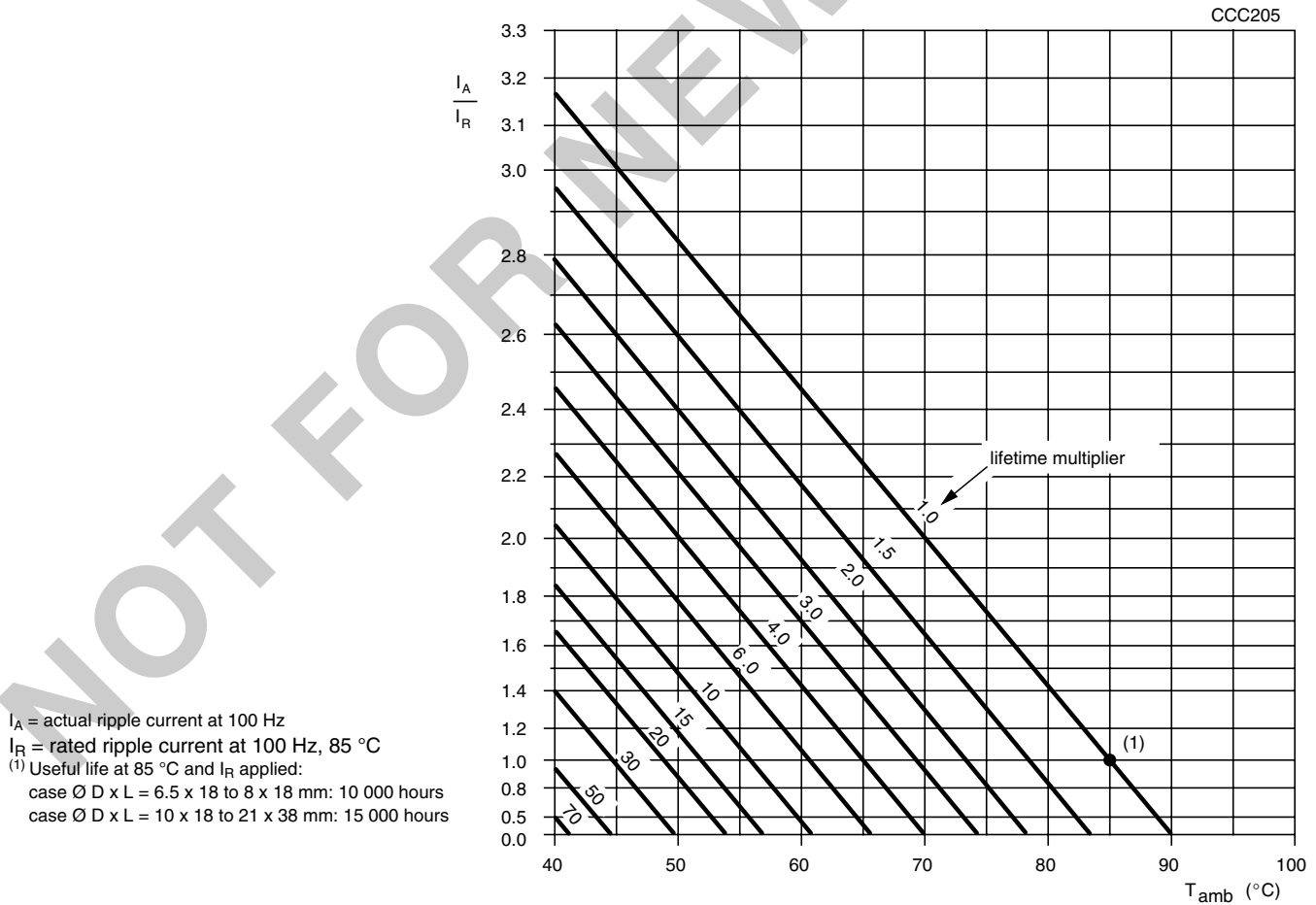

Fig.11 Multiplier of useful life as a function of ambient temperature and ripple current load

Table 4

MULTIPLIER OF RIPPLE CURRENT (I_R) AS A FUNCTION OF FREQUENCY			
FREQUENCY (Hz)	I_R MULTIPLIER		
	$U_R = 10\text{ V and }16\text{ V}$	$U_R = 25\text{ V and }63\text{ V}$	$U_R = 100\text{ V to }250\text{ V}$
50	0.95	0.90	0.85
100	1.00	1.00	1.00
300	1.07	1.12	1.20
1000	1.12	1.20	1.30
3000	1.15	1.25	1.35
$\geq 10\ 000$	1.20	1.30	1.40

Table 5

TEST PROCEDURES AND REQUIREMENTS			
TEST		PROCEDURE (quick reference)	REQUIREMENTS
NAME OF TEST	REFERENCE		
Endurance	IEC 60384-4/ EN130300 subclause 4.13	$T_{amb} = 85\text{ }^\circ\text{C}$; U_R applied; Case $\emptyset D \times L = 6.5\text{ mm} \times 18\text{ mm}$ to $8\text{ mm} \times 18\text{ mm}$: 6000 hours; Case $\emptyset D \times L = 10\text{ mm} \times 18\text{ mm}$ to $21\text{ mm} \times 38\text{ mm}$: 8000 hours	$U_R = 10\text{ V to }160\text{ V}$; $\Delta C/C$: $\pm 15\%$ $U_R = 250\text{ V}$; $\Delta C/C$: $\pm 10\%$ $\tan \delta \leq 1.3 \times \text{spec. limit}$ $Z \leq 2 \times \text{spec. limit}$ $I_{L5} \leq \text{spec. limit}$
Useful life	CECC 30301 subclause 1.8.1	$T_{amb} = 85\text{ }^\circ\text{C}$; U_R and I_R applied; Case $\emptyset D \times L = 6.5\text{ mm} \times 18\text{ mm}$ to $8\text{ mm} \times 18\text{ mm}$: 10 000 hours; Case $\emptyset D \times L = 10\text{ mm} \times 18\text{ mm}$ to $21\text{ mm} \times 38\text{ mm}$: 15 000 hours	$U_R = 10\text{ V to }160\text{ V}$; $\Delta C/C$: $\pm 45\%$ $U_R = 250\text{ V}$; $\Delta C/C$: $\pm 30\%$ $\tan \delta \leq 3 \times \text{spec. limit}$ $Z \leq 3 \times \text{spec. limit}$ $I_{L5} \leq \text{spec. limit}$ no short or open circuit total failure percentage: $\leq 1\%$
Shelf life (storage at high temperature)	IEC 60384-4/ EN130300 subclause 4.17	$T_{amb} = 85\text{ }^\circ\text{C}$; no voltage applied; 500 hours; After test: U_R to be applied for 30 minutes, 24 hours to 48 hours before measurement	$\Delta C/C$, $\tan \delta$, Z : for requirements see 'Endurance test' above $I_{L5} \leq 2 \times \text{spec. limit}$



Disclaimer

All product specifications and data are subject to change without notice.

Vishay Intertechnology, Inc., its affiliates, agents, and employees, and all persons acting on its or their behalf (collectively, "Vishay"), disclaim any and all liability for any errors, inaccuracies or incompleteness contained herein or in any other disclosure relating to any product.

Vishay disclaims any and all liability arising out of the use or application of any product described herein or of any information provided herein to the maximum extent permitted by law. The product specifications do not expand or otherwise modify Vishay's terms and conditions of purchase, including but not limited to the warranty expressed therein, which apply to these products.

No license, express or implied, by estoppel or otherwise, to any intellectual property rights is granted by this document or by any conduct of Vishay.

The products shown herein are not designed for use in medical, life-saving, or life-sustaining applications unless otherwise expressly indicated. Customers using or selling Vishay products not expressly indicated for use in such applications do so entirely at their own risk and agree to fully indemnify Vishay for any damages arising or resulting from such use or sale. Please contact authorized Vishay personnel to obtain written terms and conditions regarding products designed for such applications.

Product names and markings noted herein may be trademarks of their respective owners.