

Aluminum Capacitors SMD (Chip) Standard

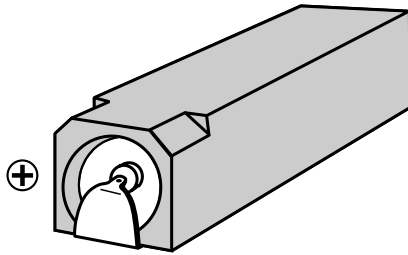
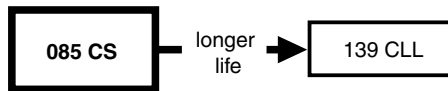


Fig.1 Component outlines



QUICK REFERENCE DATA	
DESCRIPTION	VALUE
Nominal case sizes (L x W x H in mm)	8.8 x 3.7 x 3.9 and 11.9 x 3.7 x 3.9
Rated capacitance range, C _R	0.47 to 22 μF
Tolerance on C _R	- 10 to + 50 % or ± 20 %
Rated voltage range, U _R	6.3 to 63 V
Category temperature range	- 40 to + 85 °C
Endurance test at 85 °C	1000 hours
Useful life at 85 °C	1500 hours
Useful life at 40 °C; 1.4 x I _R applied	40 000 hours
Shelf life at 0 V, 85 °C	500 hours
Resistance to soldering heat test	immersion in solder: 10 s at 260 °C or 20 s at 215 °C
Based on sectional specification	IEC 60384-18/CECC 32300
Climatic category IEC 60068	40/085/56

FEATURES

- Polarized aluminum electrolytic capacitors, non-solid electrolyte, self healing
- SMD-version, rectangular case, insulated
- Miniaturized, high CV per unit volume, low height
- Flexible terminals, reflow and wave solderable
- Charge and discharge proof
- Supplied in blister tape on reel



APPLICATIONS

- SMD technology, boards with restricted mounting height
- General applications, consumer electronics, low profile and lightweight equipment
- Decoupling, smoothing, filtering and buffering

MARKING

The capacitors are marked (where possible) with the following information:

- Rated capacitance (in μF)
- Rated voltage code (see Table 1), the U_R code letter indicates the position of the decimal point in the capacitance value
- Name of manufacturer
- '-' sign indicating the cathode. The anode is identified by bevelled edges

Examples for C_R; U_R marking:

H22 represents 0.22 μF; 63 V

2G2 represents 2.2 μF; 40 V

22C represents 22 μF; 6.3 V

Table 1

RATED VOLTAGE MARKING CODE						
U _R (V)	6.3	10	16	25	40	63
Code letter	C	D	E	F	G	H

SELECTION CHART FOR C _R , U _R AND RELEVANT NOMINAL CASE SIZES (L x W x H in mm)						
C _R (μF)	U _R (V)					
	6.3	10	16	25	40	63
0.47	-	-	-	-	-	8.8 x 3.7 x 3.9
1.0	-	-	-	-	-	8.8 x 3.7 x 3.9
2.2	-	-	-	-	8.8 x 3.7 x 3.9	11.9 x 3.7 x 3.9
3.3	-	-	-	8.8 x 3.7 x 3.9	-	11.9 x 3.7 x 3.9
4.7	-	-	8.8 x 3.7 x 3.9	-	11.9 x 3.7 x 3.9	-
6.8	-	8.8 x 3.7 x 3.9	-	11.9 x 3.7 x 3.9	-	-
10	8.8 x 3.7 x 3.9	-	11.9 x 3.7 x 3.9	-	-	-
15	-	11.9 x 3.7 x 3.9	-	-	-	-
22	11.9 x 3.7 x 3.9	-	-	-	-	-

DIMENSIONS in millimeters

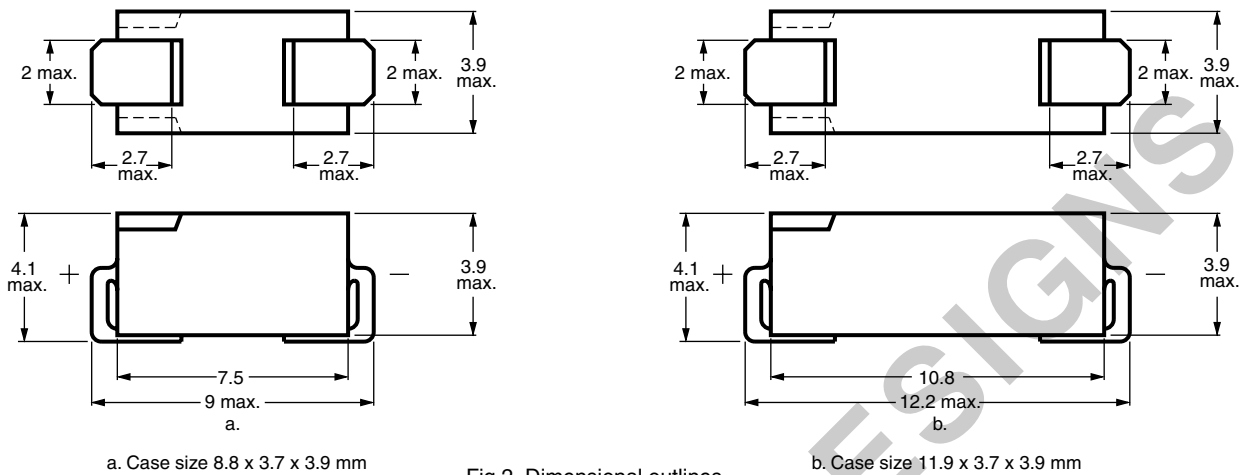


Fig.2 Dimensional outlines

PACKAGING

Tape on reel packaging: 2000 per reel
Detailed tape dimensions see section 'PACKAGING'

MOUNTING

The capacitors are designed for automatic placement on printed-circuit boards or hybrid circuits.
Optimum dimensions of soldering pads depend upon soldering method, mounting accuracy, print lay-out and/or adjacent components.
For recommended pad dimensions, refer to Fig. 3 and Table 2.

Table 2

NOMINAL CASE SIZE L x W x H	FOR REFLOW SOLDERING							FOR WAVE SOLDERING						
	A	B	C	D	E	F	G	A	B	C	D	E	F	G
8.8 x 3.7 x 3.9	9.7	3.5	2.9	2.5	3.0	10.1	4.4	13.5	4.1	4.7	3.7	2.9	14.0	8.4
11.9 x 3.7 x 3.9	12.9	6.5	2.9	2.5	6.0	13.3	4.4	16.8	7.4	4.7	3.7	6.1	17.3	8.4

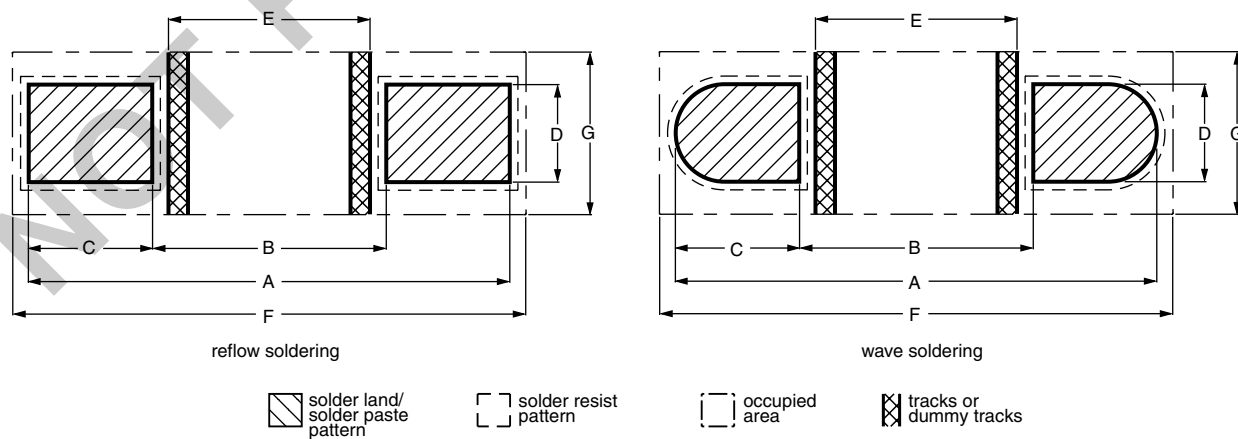
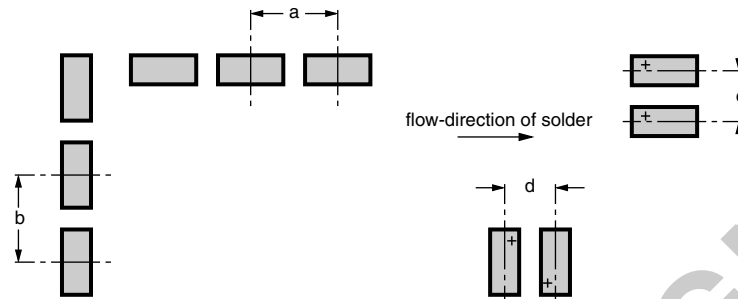


Fig.3 Recommended pad dimensions for reflow and wave soldering



For dimensions a, b, c and d, refer to Table 3
 Flow direction of solder preferably onto side-walls or plus-side of the capacitors

Fig.4 Minimum distances between 085 CS capacitors on a printed-circuit board for wave soldering

SOLDERING

Soldering conditions are defined by the curve, temperature versus time. The temperature is that measured on the soldering pad during processing.

Any temperature/time curve which does not exceed the specified maximum curves may be applied.

For maximum conditions of different soldering methods see Figs 5, 6 and 7.

AS A GENERAL PRINCIPLE, TEMPERATURE AND DURATION SHALL BE THE MINIMUM NECESSARY REQUIRED TO ENSURE GOOD SOLDERING CONNECTIONS.

Table 3

MINIMUM DISTANCES BETWEEN CAPACITORS in millimeters					
NOMINAL CASE SIZE L x W x H	CASE CODE	a _{min.}	b _{min.}	c _{min.}	d _{min.}
8.8 x 3.7 x 3.9	1a	12	12	6.8	6.8
11.9 x 3.7 x 3.9	1	15	15	6.8	6.8

Table4

CURING CONDITIONS FOR SMD-GLUE	
MAX. T _{amb} (°C)	MAX. EXPOSURE TIME (minutes)
125	10
140	3
150	1
160	0.5

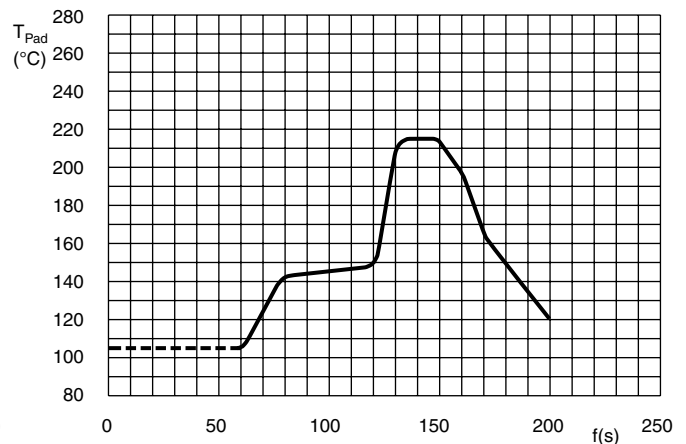
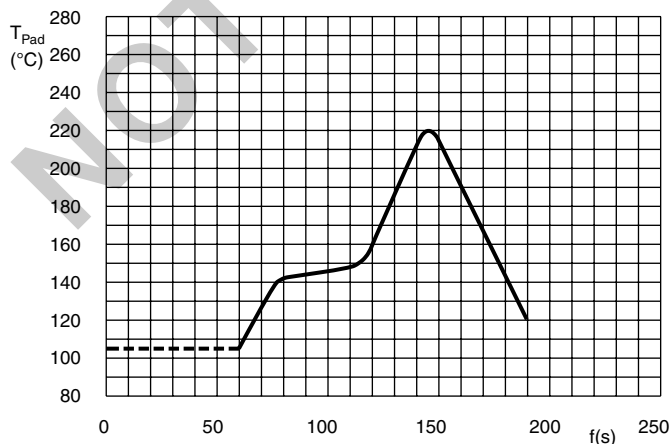


Fig.5 Maximum temperature load during infrared reflow soldering Fig.6 Maximum temperature load during vapor phase reflow soldering

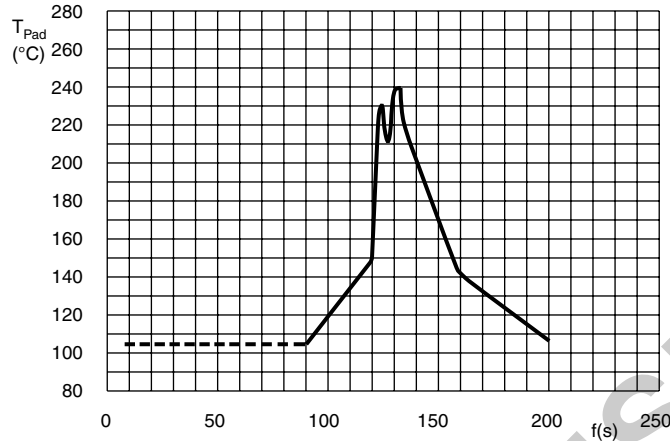


Fig.7 Maximum temperature load during (double-) wave soldering

ELECTRICAL DATA	
SYMBOL	DESCRIPTION
C _R	rated capacitance at 100 Hz (tolerance - 10 to + 50 % or ± 20 %)
I _R	rated RMS ripple current at 100 Hz, 85 °C
I _{L5}	max. leakage current after 5 minutes at U _R
Tan δ	max. dissipation factor at 100 Hz
Z	max. impedance at 10 kHz

ORDERING EXAMPLE

Electrolytic capacitor 085 series
 10 μF/16 V; - 10/+ 50 %
 Nominal case size: 11.9 x 3.7 x 3.9 mm; Form BR
 Ordering Code: MAL208525109E3
 Former 12NC: 2222 085 25109

Note

Unless otherwise specified, all electrical values in Table 6 apply at T_{amb} = 20 °C, P = 86 to 106 kPa, RH = 45 to 75 %.

Table 6

ELECTRICAL DATA AND ORDERING INFORMATION								
U _R (V)	C _R 100 Hz (μF)	NOMINAL CASE SIZE L x W x H (mm)	I _R 100 Hz 85 °C (mA)	I _{L5} 5 min (μA)	Tan δ 100 Hz	Z 10 kHz (Ω)	ORDERING CODE MAL2085.....	
							- 10/+ 50 %	± 20 %
							BLISTER TAPE ON REEL FORM BR	BLISTER TAPE ON REEL FORM BR
6.3	10.0	8.8 x 3.7 x 3.9	11	3.1	0.30	20	23109E3	63109E3
	22	11.9 x 3.7 x 3.9	20	3.3	0.30	9	23229E3	63229E3
10	6.8	8.8 x 3.7 x 3.9	10	3.1	0.25	24	24688E3	64688E3
	15	11.9 x 3.7 x 3.9	18	3.3	0.25	11	24159E3	64159E3
16	4.7	8.8 x 3.7 x 3.9	9	3.2	0.20	26	25478E3	65478E3
	10	11.9 x 3.7 x 3.9	16	3.3	0.20	12	25109E3	65109E3
25	3.3	8.8 x 3.7 x 3.9	8	3.2	0.18	27	26338E3	66338E3
	6.8	11.9 x 3.7 x 3.9	14	3.3	0.18	13	26688E3	66688E3
40	2.2	8.8 x 3.7 x 3.9	7	3.2	0.16	32	27228E3	67228E3
	4.7	11.9 x 3.7 x 3.9	13	3.4	0.16	15	27478E3	67478E3
63	0.47	8.8 x 3.7 x 3.9	4	3.1	0.10	120	28477E3	68477E3
	1.0	8.8 x 3.7 x 3.9	6	3.1	0.12	55	28108E3	68108E3
	2.2	11.9 x 3.7 x 3.9	11	3.3	0.14	25	28228E3	68228E3
	3.3	11.9 x 3.7 x 3.9	13	3.4	0.14	17	28338E3	68338E3

Table 7

ADDITIONAL ELECTRICAL DATA		
PARAMETER	CONDITIONS	VALUE
Voltage		
Surge voltage for short periods		$U_s \leq 1.15 \times U_R$
Reverse voltage		$U_{rev} \leq 1 \text{ V}$
Current		
Leakage current	after 1 minute at U_R	$I_{L1} \leq 0.02 C_R \times U_R + 3 \mu\text{A}$
	after 5 minutes at U_R	$I_{L5} \leq 0.002 C_R \times U_R + 3 \mu\text{A}$
Inductance		
Equivalent series inductance (ESL)	nominal case size 8.8 x 3.7 x 3.9 mm	typ. 11 nH
	nominal case size 11.9 x 3.7 x 3.9 mm	typ. 13 nH
Resistance		
Equivalent series resistance (ESR)	calculated from $\tan \delta_{max}$ and C_R (see Table	$ESR = \tan \delta / 2 \pi f C_R$

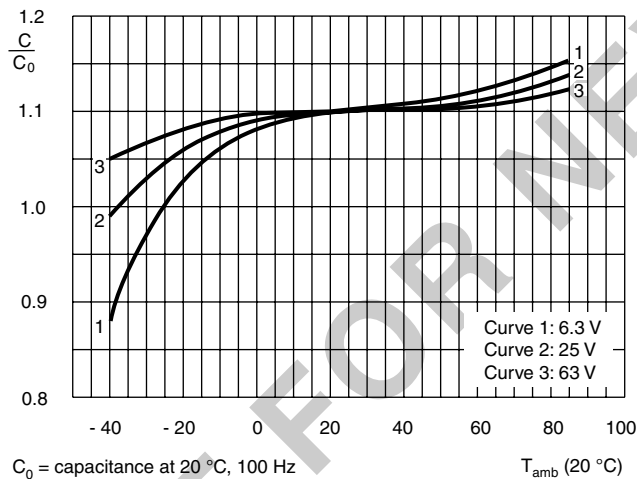
CAPACITANCE


Fig.7 Typical multiplier of capacitance as a function of ambient temperature

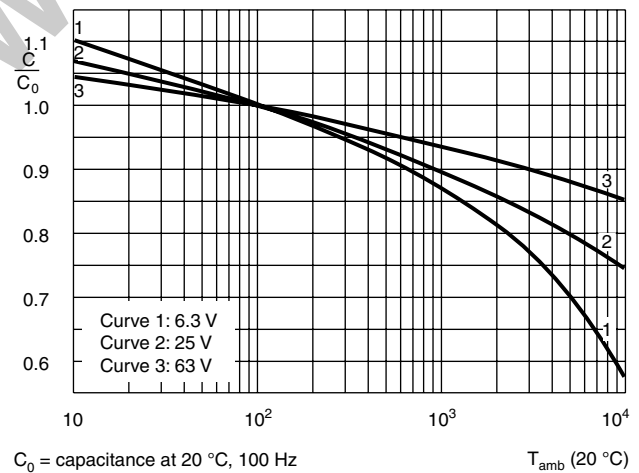
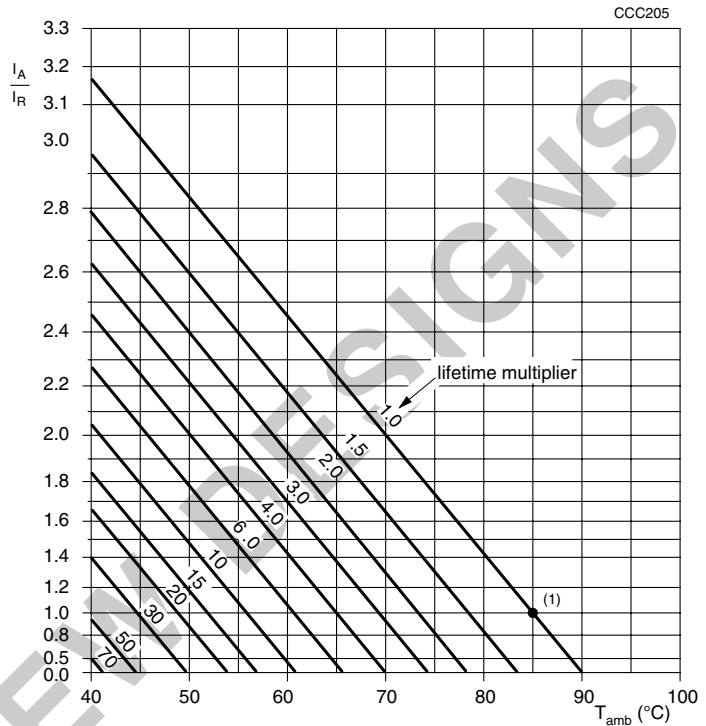


Fig.9 Typical multiplier of capacitance as a function of frequency

RIPPLE CURRENT AND USEFUL LIFE



I_A = actual ripple current at 100 Hz.
 I_R = rated ripple current at 100 Hz, 85 °C
 (1) Useful life at 85 °C and I_R applied: 1500 hours

Fig.10 Multiplier of useful life as a function of ambient temperature and ripple current load

Table 8

MULTIPLIER OF RIPPLE CURRENT (I_R) AS A FUNCTION OF FREQUENCY			
FREQUENCY (Hz)	I_R MULTIPLIER		
	$U_R = 6.3$ to 16 V	$U_R = 25$ to 40 V	$U_R = 63$ V
50	0.80	0.75	0.70
100	1.00	1.00	1.00
300	1.20	1.30	1.55
1000	1.35	1.55	1.90
3000	1.45	1.70	2.30
$\geq 10\ 000$	1.50	1.80	2.50

TEST PROCEDURES AND REQUIREMENTS			
TEST		PROCEDURE (quick reference)	REQUIREMENTS
NAME OF TEST	REFERENCE		
Mounting	IEC 60384-18, subclause 4.3	shall be performed prior to tests mentioned below; method: reflow or (double-) wave soldering; for maximum temperature load refer to chapter "Mounting"	$\Delta C/C: \pm 10\%$ $\tan \delta \leq \text{spec. limit}$ $I_{L5} \leq 2 \times \text{spec. limit}$
Endurance	IEC 60384-18/ CECC 32300, subclause 4.15	$T_{\text{amb}} = 85\text{ }^\circ\text{C}$; U_R applied; 1000 hours	$\Delta C/C: \pm 20\%$ $\tan \delta \leq 2 \times \text{spec. limit}$ $Z \leq 3 \times \text{spec. limit}$ $I_{L5} \leq \text{spec. limit}$
Useful life	CECC 30301, subclause 1.8.1	$T_{\text{amb}} = 85\text{ }^\circ\text{C}$; U_R and I_R applied; 1500 hours	$\Delta C/C: \pm 50\%$ $\tan \delta \leq 3 \times \text{spec. limit}$ $Z \leq 3 \times \text{spec. limit}$ $I_{L5} \leq \text{spec. limit}$ no short or open circuit total failure percentage: $\leq 3\%$
Shelf life (storage at high temperature)	IEC 60384-18/ CECC 32300, subclause 4.17	$T_{\text{amb}} = 85\text{ }^\circ\text{C}$; no voltage applied; 500 hours after test: U_R to be applied for 30 minutes, 24 to 48 hours before measurement	$\Delta C/C, \tan \delta, Z$: for requirements see 'Endurance test' above $I_{L5} \leq 2 \times \text{spec. limit}$



Disclaimer

All product specifications and data are subject to change without notice.

Vishay Intertechnology, Inc., its affiliates, agents, and employees, and all persons acting on its or their behalf (collectively, "Vishay"), disclaim any and all liability for any errors, inaccuracies or incompleteness contained herein or in any other disclosure relating to any product.

Vishay disclaims any and all liability arising out of the use or application of any product described herein or of any information provided herein to the maximum extent permitted by law. The product specifications do not expand or otherwise modify Vishay's terms and conditions of purchase, including but not limited to the warranty expressed therein, which apply to these products.

No license, express or implied, by estoppel or otherwise, to any intellectual property rights is granted by this document or by any conduct of Vishay.

The products shown herein are not designed for use in medical, life-saving, or life-sustaining applications unless otherwise expressly indicated. Customers using or selling Vishay products not expressly indicated for use in such applications do so entirely at their own risk and agree to fully indemnify Vishay for any damages arising or resulting from such use or sale. Please contact authorized Vishay personnel to obtain written terms and conditions regarding products designed for such applications.

Product names and markings noted herein may be trademarks of their respective owners.