

Features

- RoHS compliant* (see How to Order "Termination" option)
- Standard E.I.A. package compatible with automatic placement equipment
- Tape and reel packaging standard
- Custom circuits are available
- Marking on contrasting background for permanent identification
- Compliant leads to reduce solder joint fatiguing
- Standard electrical schematics: isolated, bussed, dual terminator
- Now available with improved tolerance to $\pm 0.5\%$

4800P Series - Thick Film Surface Mounted Medium Body

Product Characteristics

Resistance Range 10 ohms to 2.2 megohms
 Maximum Operating Voltage 50 V
 Temperature Coefficient of Resistance
 50 Ω and above ± 100 ppm/ $^{\circ}$ C
 below 50 Ω ± 250 ppm/ $^{\circ}$ C
 TCR Tracking
 (for equal values within a package)
 50 ppm/ $^{\circ}$ C max. for values > 50 Ω ;
 100 ppm/ $^{\circ}$ C for values \leq 50 Ω
 Operating Temperature
 -55 $^{\circ}$ C to +125 $^{\circ}$ C
 Insulation Resistance
 10,000 megohms min.
 Dielectric Withstanding Voltage
 200 VRMS
 Lead Solderability Meet requirements
 of MIL-STD-202 Method 208

Environmental Characteristics

TESTS PER MIL-STD-202 ΔR MAX.
 Short Time Overload $\pm 0.25\%$
 Load Life $\pm 1.00\%$
 Moisture Resistance $\pm 0.50\%$
 Resistance to Soldering Heat ... $\pm 0.25\%$
 Thermal Shock $\pm 0.25\%$

Physical Characteristics

Flammability Conforms to UL94V-0
 Lead Frame Material
 Copper, solder coated
 Body Material Thermoplastic

How To Order

48 16 P - 1 - 103

Model _____
 (48 = SOM Pkg.)

Number of Pins _____

Electrical Configuration _____
 • 1 or 4 = Isolated*
 • 2 = Bussed*
 • 3 = Dual Terminator*

Resistance Code _____
 • First 2 digits are significant
 • Third digit represents the number of zeros to follow.

Resistance Tolerance _____
 • Blank = $\pm 2\%$ (see "Resistance Tolerance" on next page for resistance range)
 • F = $\pm 1\%$ (100 ohms - 1 megohm)
 • D = $\pm 0.5\%$ (100 ohms - 1 megohm)

Terminations _____
 • All electrical configurations EXCEPT T03:
 LF = RoHS compliant
 • ONLY electrical configuration T03:
 L = RoHS compliant
 • Blank = Tin/Lead-plated

*For tube packaging, use T01, T02, T03 or T04.
 Consult factory for other available options.

Package Power Temp. Derating Curve

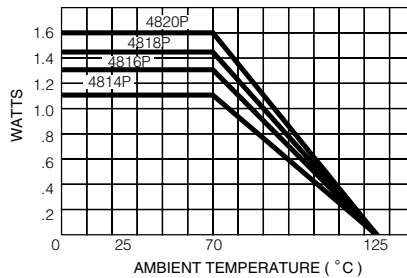

Package Power Rating at 70 °C

4814P 1.12 watts
 4816P 1.28 watts
 4818P 1.44 watts
 4820P 1.60 watts

Typical Part Marking

Represents total content. Layout may vary.

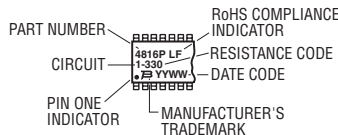

Recommended Land Pattern

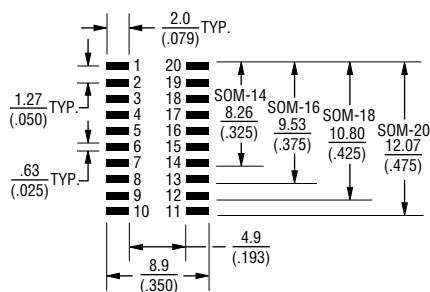

NOTE: Land pattern dimensions are based on design rules established by the Institute for Interconnecting and Packaging Electronic Circuits in IPC-SM-782.

For Standard Values Used in Capacitors, Inductors, and Resistors, [click here](#).

Product Dimensions

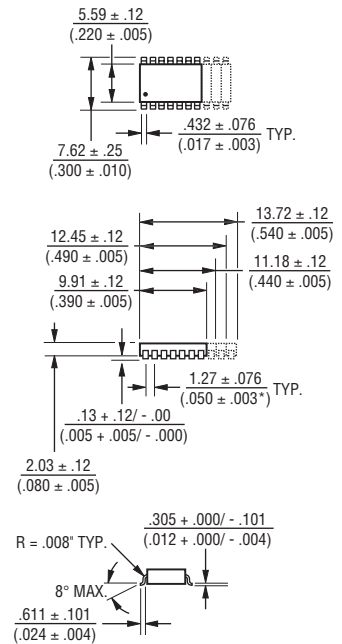

Lead coplanarity .102mm (.004 inch) max. at mounting surface.

Governing dimensions are in metric. Dimensions in parentheses are inches and are approximate.

*Terminal centerline to centerline measurements made at point of emergence of the lead from the body.

For information on specific applications, download Bourns' application notes:

- DRAM Applications
- Dual Terminator Resistor Networks
- R/2R Ladder Networks
- SCSI Applications

4800P Series - Thick Film Surface Mounted Medium Body

BOURNS®

Isolated Resistors (1 and 4 Circuits)

Model 4814P-1
 Model 4816P-1 (Shown)
 Model 4818P-1
 Model 4820P-1

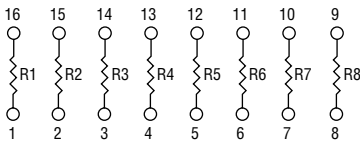

Model 4816P-4 (Shown)
 Model 4820P-4

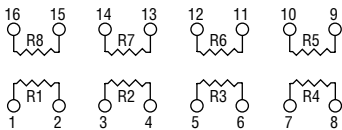

Resistance Tolerance

10 ohms to 49 ohms±1 ohm
 50 ohms to 2.2 megohms±2 %*

Power Rating per Resistor

1 Circuit at 70 °C0.160 watt
 4 Circuit at 70 °C0.160 watt

Resistor Power Temp. Derating Curve

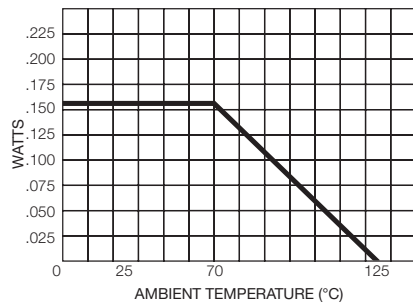

Bussed Resistors (2 Circuit)

Model 4814P-2
 Model 4816P-2 (Shown)
 Model 4818P-2
 Model 4820P-2

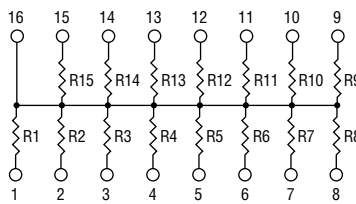

Resistance Tolerance

10 ohms to 49 ohms±1 ohm
 50 ohms to 2.2 megohms±2 %*

Power Rating per Resistor

2 Circuit at 70 °C0.080 watt

Resistor Power Temp. Derating Curve

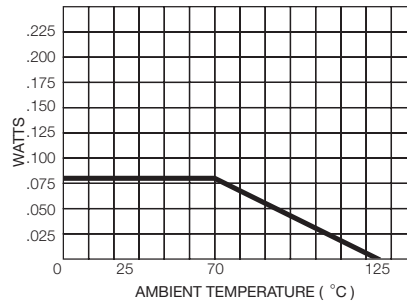

Dual Terminator (3 Circuit)

Model 4814P-3
 Model 4816P-3 (Shown)
 Model 4818P-3
 Model 4820P-3

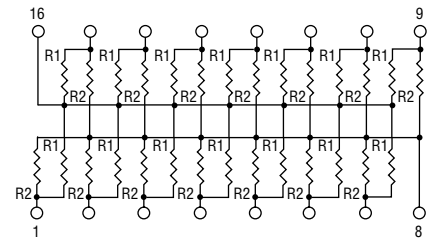

Resistance Tolerance

Below 100 ohms±2 ohms
 100 ohms to 2.2 megohms±2 %*

Power Rating per Resistor

3 Circuit at 70 °C0.080 watt

Resistor Power Temp. Derating Curve

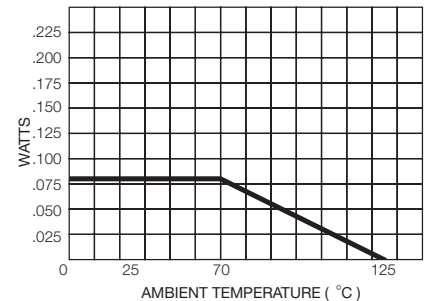

Popular Resistance Values (1, 4 and 2 Circuits)**

| Ohms | Code | Ohms | Code | Ohms | Code | Ohms | Code | Ohms | Code |
|------|------|-------|------|--------|------|---------|------|-----------|------|
| 10 | 100 | 180 | 181 | 1,800 | 182 | 15,000 | 153 | 120,000 | 124 |
| 22 | 220 | 220 | 221 | 2,000 | 202 | 18,000 | 183 | 150,000 | 154 |
| 27 | 270 | 270 | 271 | 2,200 | 222 | 20,000 | 203 | 180,000 | 184 |
| 33 | 330 | 330 | 331 | 2,700 | 272 | 22,000 | 223 | 220,000 | 224 |
| 39 | 390 | 390 | 391 | 3,300 | 332 | 27,000 | 273 | 270,000 | 274 |
| 47 | 470 | 470 | 471 | 3,900 | 392 | 33,000 | 333 | 330,000 | 334 |
| 56 | 560 | 560 | 561 | 4,700 | 472 | 39,000 | 393 | 390,000 | 394 |
| 68 | 680 | 680 | 681 | 5,600 | 562 | 47,000 | 473 | 470,000 | 474 |
| 82 | 820 | 820 | 821 | 6,800 | 682 | 56,000 | 563 | 560,000 | 564 |
| 100 | 101 | 1,000 | 102 | 8,200 | 822 | 68,000 | 683 | 680,000 | 684 |
| 120 | 121 | 1,200 | 122 | 10,000 | 103 | 82,000 | 823 | 820,000 | 824 |
| 150 | 151 | 1,500 | 152 | 12,000 | 123 | 100,000 | 104 | 1,000,000 | 105 |

Popular Resistance Values (3 Circuit)**

| Resistance | | | |
|----------------|----------------|----------------|----------------|
| Ohms | | Code | |
| R ₁ | R ₂ | R ₁ | R ₂ |
| 160 | 240 | 161 | 241 |
| 180 | 390 | 181 | 391 |
| 220 | 270 | 221 | 271 |
| 220 | 330 | 221 | 331 |
| 330 | 390 | 331 | 391 |
| 330 | 470 | 331 | 471 |
| 3,000 | 6,200 | 302 | 622 |

* Add "F" after resistance code for ±1 % tolerance available from 100 Ω through 1M Ω, or add "D" after resistance code for ±0.5 % tolerance available from 100 Ω through 1M Ω.
 Part number suffix examples: -103 = 10K Ω, ±2 %; -103F = 10K Ω, ±1 %; -103D = 10K Ω, ±0.5 %

** Non-standard values available, within resistance range.

Surface Mounted Ordering Guide

BOURNS®

| Electrical Configuration | *Circuit Codes | | Examples |
|--------------------------|----------------|-------|---|
| | Tape & Reel | Tubes | |
| Isolated | 1 | T01 | 4816P-1-101 |
| Bussed | 2 | T02 | Isolated Circuit in Tape & Reel Package |
| Dual Terminated | 3 | T03 | 4816P-T01-101 |
| Adj. Isolated | 4 | T04 | Isolated Circuit in Slide Tube Package |

*4816P-X-RC: To specify package type, replace "X" with appropriate "Circuit Code".

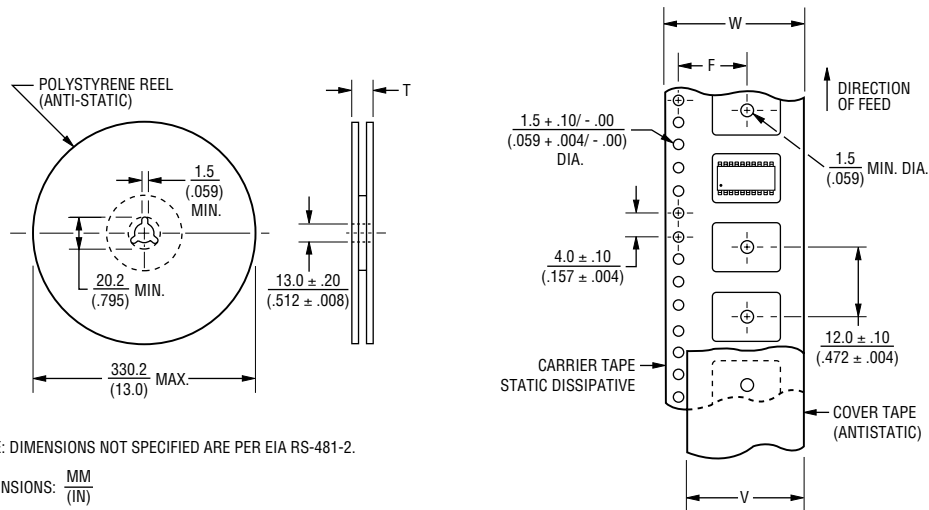

NOTE: DIMENSIONS NOT SPECIFIED ARE PER EIA RS-481-2.

DIMENSIONS: $\frac{MM}{(IN)}$

| Model | Standard Quantity per Reel | Carrier Tape Width (W) | Cover Tape Width (W) | Reel Width (T) | Pocket Center (F) |
|-------|----------------------------|--|----------------------|-----------------------------|--|
| 4814P | 2,000 | $\frac{24.0 \pm .30}{(.945 \pm .012)}$ | 21.0 (.827) NOM. | $\frac{30.4}{(1.197)}$ MAX. | $\frac{11.5 \pm .10}{(.453 \pm .004)}$ |
| 4816P | | | | | |
| 4818P | | | | | |
| 4820P | | | | | |

Leader Length = 500 min. } Empty Component Pockets
 Trailer Length = 500 mm min. } Sealed with Cover Tape

Specifications are subject to change without notice. Customers should verify actual device performance in their specific applications.