

MOD-MP3-X and MOD-MP3-X-BAT
development boards
Users Manual



Pb-free, Green

All boards produced by Olimex are ROHS compliant

Revision B, January 2011

Copyright(c) 2011, OLIMEX Ltd, All rights reserved

INTRODUCTION:

MOD-MP3-X is MP3 player module based on VS1053 Ogg Vorbis/MP3/AAC/-WMA/MIDI audio decoder and an IMA ADPCM and user-loadable Ogg Vorbis encoder; supports VBR (variable bit rate) for MP3; Supports streaming. It also employs an on-board STM32F103RBT6 CORTEX-M3 microcontroller for smart control via UEXT.

MOD-MP3-X has three modes of operation:

- Standalone mode – compatible with the old revision MOD-MP3 player. In this mode VS1053 controls the playback of files written on a micro SD card inserted in the board. The user is provided with controls on volume, sound effects, starting, stopping and sequencing of files to play.
- UEXT playback mode – in this mode the board can be connected as slave device to host microcontroller which streams data to the codec via SPI.
- UEXT smart control mode – in this mode the on-board microcontroller manages playback of files written to the micro SD card. The microcontroller acts as a slave device and accepts user commands via UART. Commands include SD card directory listing, selecting of a file to play and playback and volume control.

MOD-MP3-X ships in two variants – with and without battery. The battery variant employs a Li-ion 3.7 V, 1200 mAh rechargeable battery and an on-board battery charger.

BOARD FEATURES:

- On-board STM32F103RBT6 ARM 32-bit Cortex™-M3 microcontroller
- Based on VS1053 hardware decoder
- 3.7 V Li-ion battery and battery charger (for MOD-MP3-X-BAT)
- UEXT to connect to host microcontroller (standard connector on our ARM development boards)
- Three modes of operation
- EEPROM with firmware for standalone mode
- micro SD card holder
- USB
- Stereo Audio microphone jack, Stereo Audio headphones jack
- Can be used to record and playback
- Triple action joystick: Forward, Reverse, Play/Pause action
- Wake-up button
- Two status leds
- FR-4, 1.5 mm, soldermask, component print
- Dimensions: 60 x 60 mm (2.36 x 2.36")

ELECTROSTATIC WARNING:

The **MOD-MP3-X** board is shipped in protective anti-static packaging. The board must not be subject to high electrostatic potentials. General practice for working with static sensitive devices should be applied when working with this board.

BOARD USE REQUIREMENTS:

Cables: The cable you will need depends on the programmer/debugger you use. If you use [ARM-JTAG-EW](#), you will need USB A-B cable, for all types programmers you will need ARM-JTAG-20to10 adapter.

Hardware: Programmer/Debugger [ARM-JTAG-EW](#), [ARM-USB-OCD](#), [ARM-USB-TINY](#), [ARM-USB-TINY-H](#), ARM-USB-OCD-H or other compatible programming/debugging tool. For EEPROM programming you can use **PICKit 2** development programmer/debugger from Microchip, because we don't offer a suitable programmer, yet.

PROCESSOR FEATURES:

MOD-MP3-X board use **STM32F103RBT6** microcontroller from STMicroelectronics with these features:

- Core: ARM 32-bit Cortex™-M3 CPU
 - 72 MHz, 90 DMIPS with 1.25 DMIPS/MHz
 - Single-cycle multiplication and hardware division
 - Nested interrupt controller with 43 maskable interrupt channels
 - Interrupt processing (down to 6 CPU cycles) with tail chaining
- Memories
 - 128 Kbytes of Flash memory
 - 20 Kbytes of SRAM
- Clock, reset and supply management
 - 2.0 to 3.6 V application supply and I/Os
 - POR, PDR, and programmable voltage detector (PVD)
 - 4-to-16 MHz quartz oscillator
 - Internal 8 MHz factory-trimmed RC
 - Internal 32 kHz RC
 - PLL for CPU clock
 - Dedicated 32 kHz oscillator for RTC with calibration
- Low power
 - Sleep, Stop and Standby modes
 - VBAT supply for RTC and backup registers

- 2 x 12-bit, 1 μ s A/D converters (16-channel)
 - Conversion range: 0 to 3.6 V
 - Dual-sample and hold capability
 - Synchronizable with advanced control timer
 - Temperature sensor
- DMA
 - 7-channel DMA controller
 - Peripherals supported: timers, ADC, SPIs, I²Cs and USARTs
- Debug mode
 - Serial wire debug (SWD) & JTAG interfaces
- 49 fast I/O ports
 - 49 5 V-tolerant I/Os
 - All mappable on 16 external interrupt vectors
 - Atomic read/modify/write operations
- 4 timers
 - 3 general purpose timers
 - 1 advanced control timer
- Up to 9 communication interfaces
 - 2 I²C interfaces (SMBus/PMBus)
 - 3 USARTs (ISO 7816 interface, LIN, IrDA capability, modem control)
 - 2 SPIs (18 Mbit/s)
 - CAN interface (2.0B Active)
 - USB 2.0 full speed interface

BLOCK DIAGRAM:

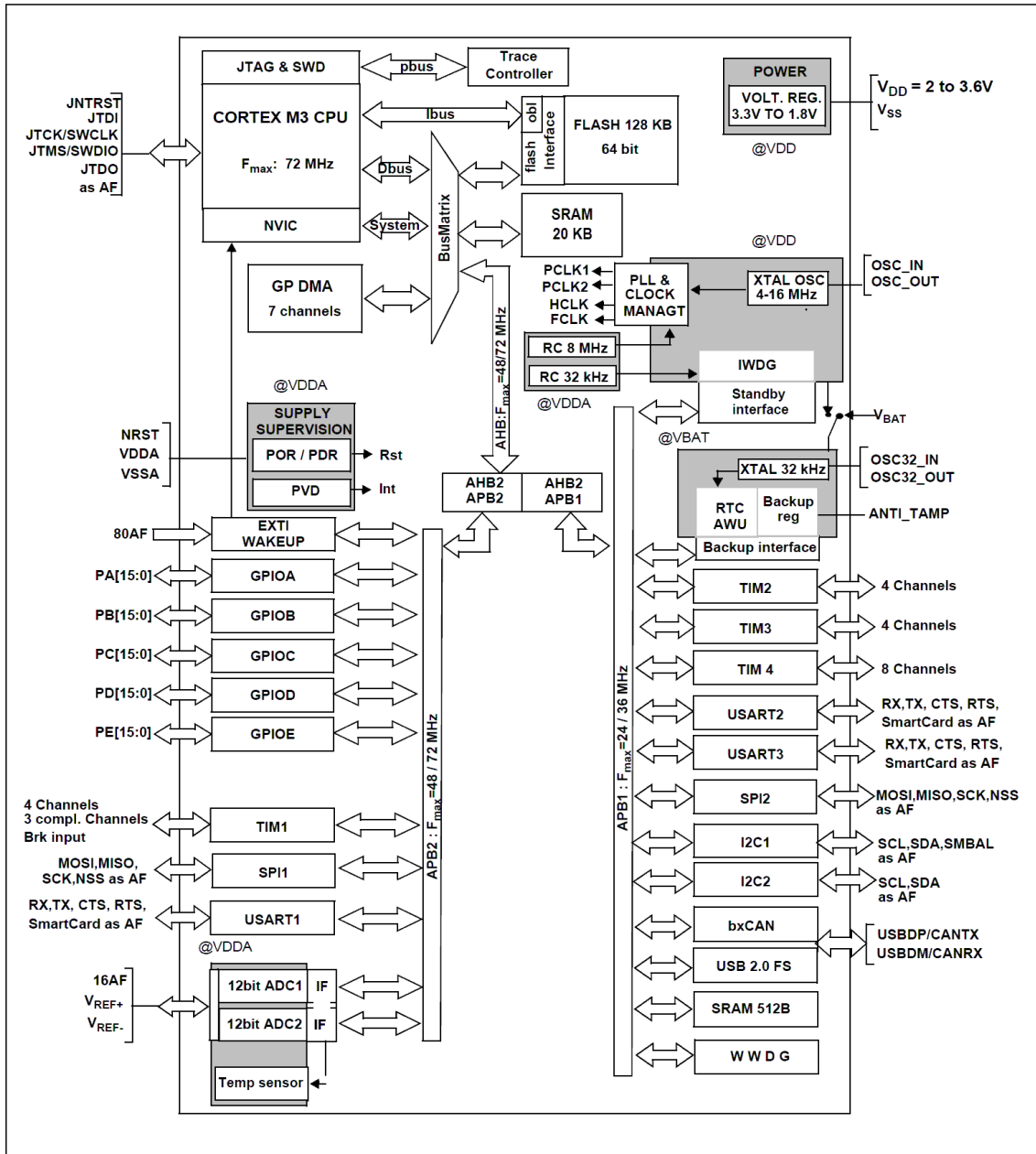

1. $T_A = -40\text{ }^\circ\text{C to } +105\text{ }^\circ\text{C}$ (junction temperature up to $125\text{ }^\circ\text{C}$).
2. AF = alternate function on I/O port pin.

MEMORY MAP:

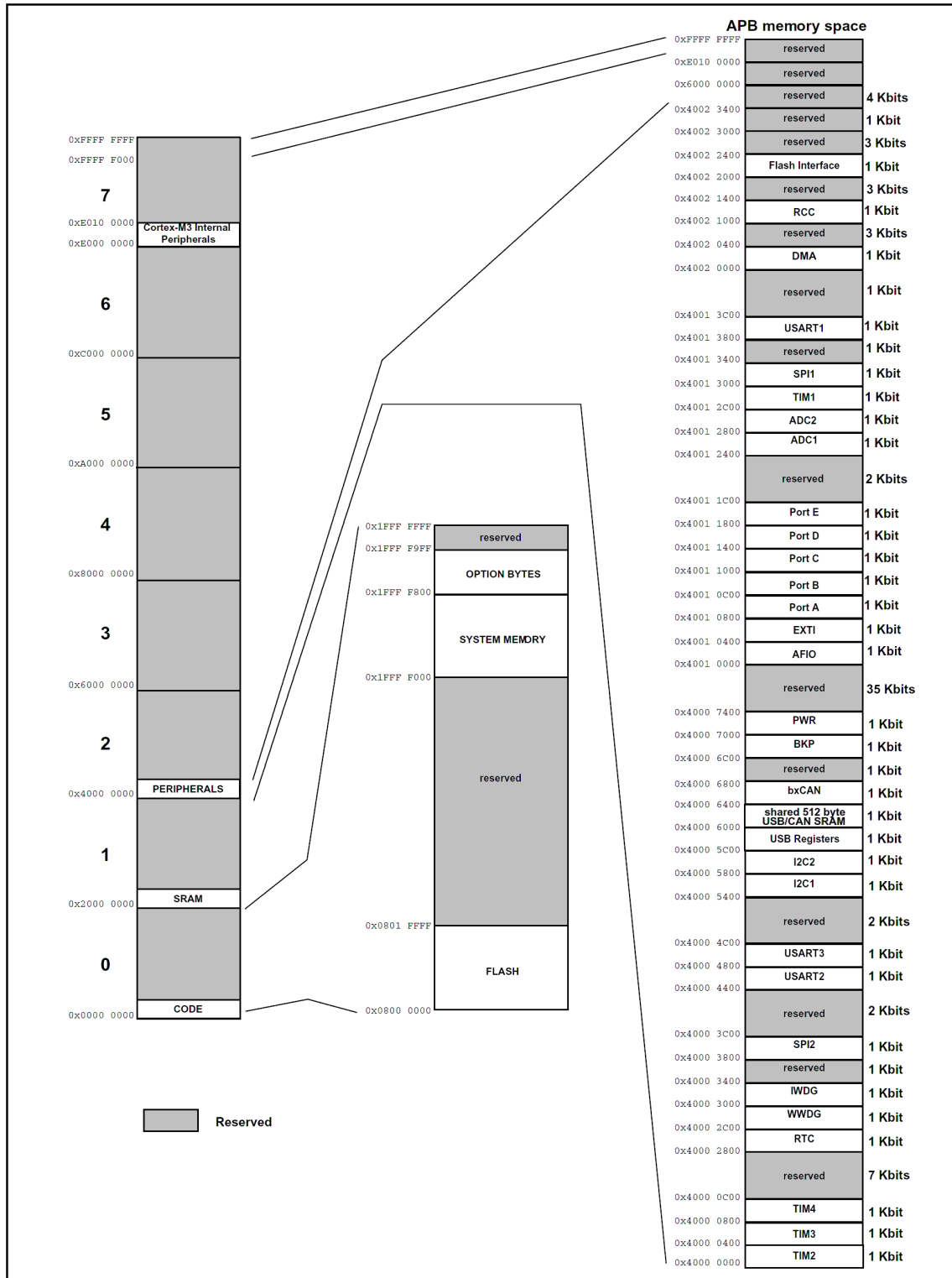

AUDIO CODEC FEATURES:

- Decodes Ogg Vorbis; MPEG 1 & 2 audio layer III (CBR +VBR +ABR); layers I & II optional; MPEG4 / 2 AAC-LC(+PNS), HE-AAC v2 (Level 3) (SBR + PS); WMA4.0/4.1/7/8/9 all profiles (5-384 kbps); WAV (PCM + IMA ADPCM); General MIDI 1 / SP-MIDI format 0 files
- Encodes Ogg Vorbis with software plugin
- Encodes IMA ADPCM from mic/line (stereo)
- Streaming support for MP3 and WAV
- EarSpeaker Spatial Processing
- Bass and treble controls
- Operates with a single 12..13MHz clock
- Can also be used with a 24..26MHz clock
- Internal PLL clock multiplier
- Low-power operation
- High-quality on-chip stereo DAC with no phase error between channels
- Zero-cross detection for smooth volume change
- Stereo earphone driver capable of driving a 30-load
- Quiet power-on and power-off
- I2S interface for external DAC
- Separate voltages for analog, digital, I/O
- On-chip RAM for user code and data
- Serial control and data interfaces
- Can be used as a slave co-processor
- SPI flash boot for special applications
- UART for debugging purposes

AUDIO CODEC BLOCK DIAGRAM:

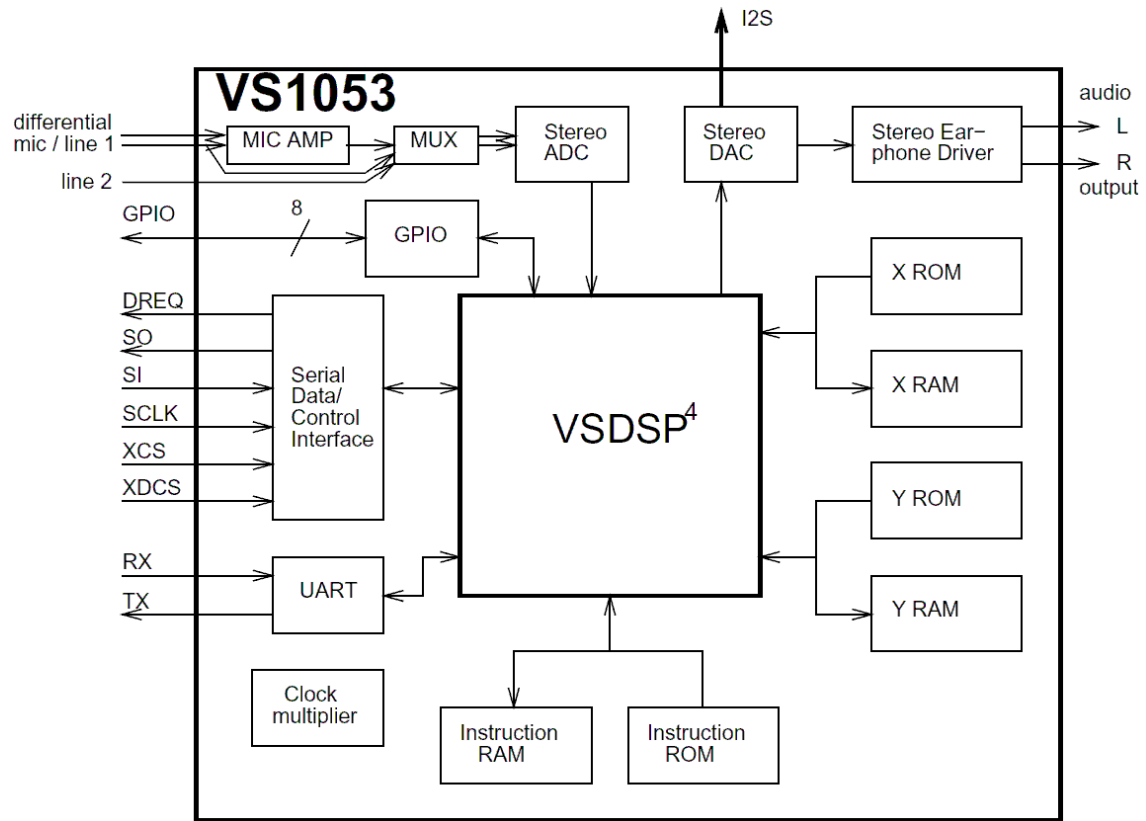

SCHEMATIC:

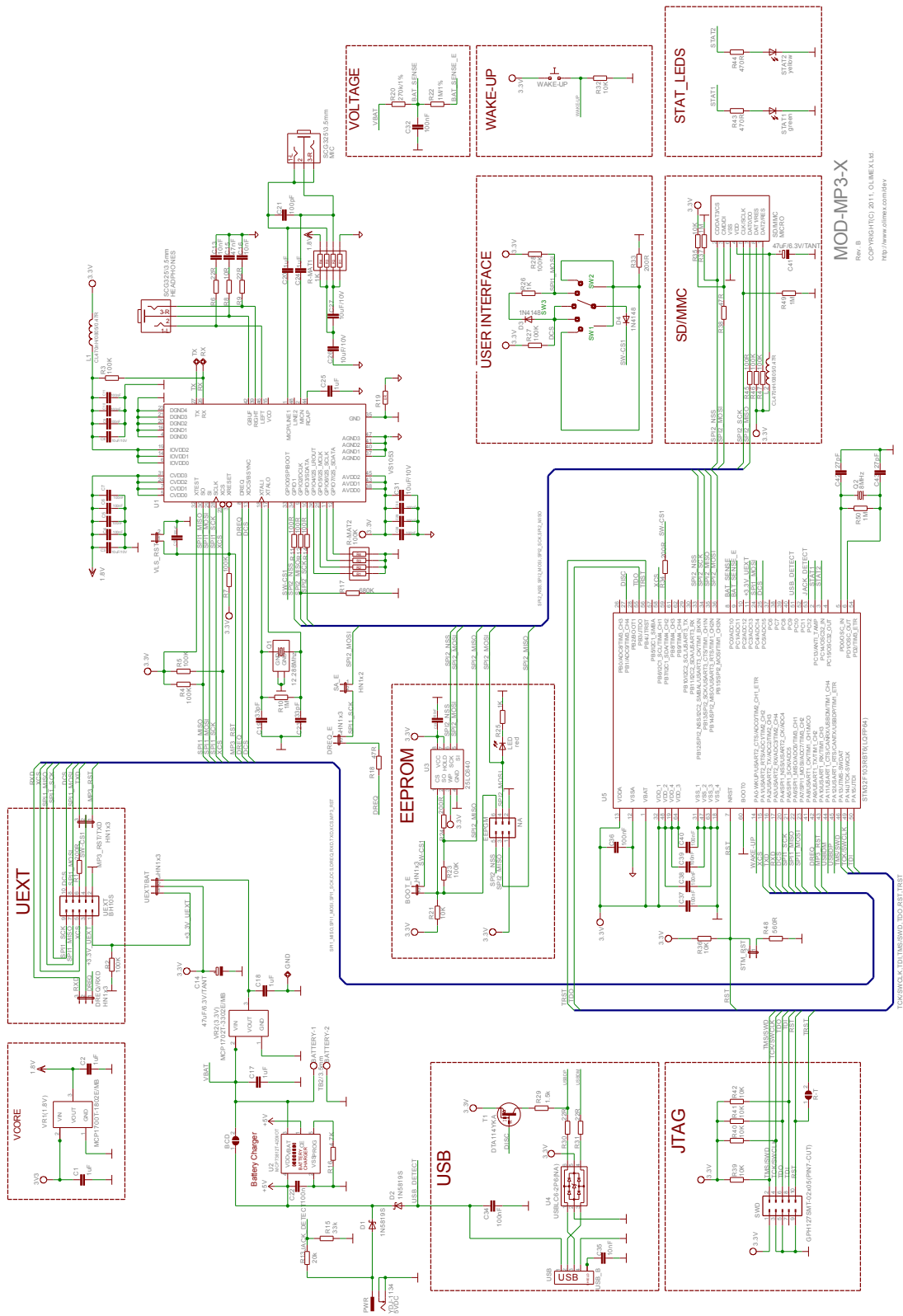

MOD-MP3-X
Rev. B
COPYRIGHT(C) 2011, O.L.MEX.L.M.I.
http://www.olmex.com/olmex/

BOARD LAYOUT:

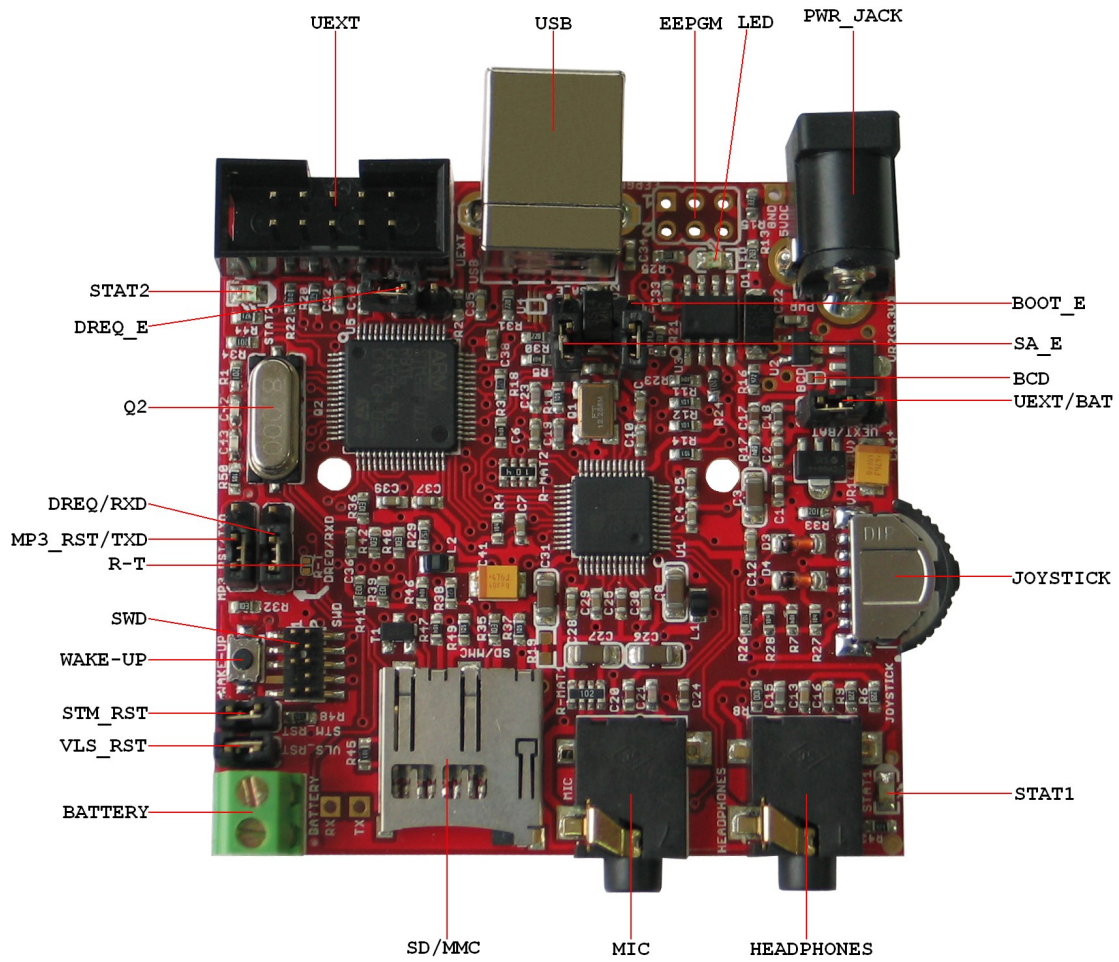

MOD-MP3-X-BAT (only):

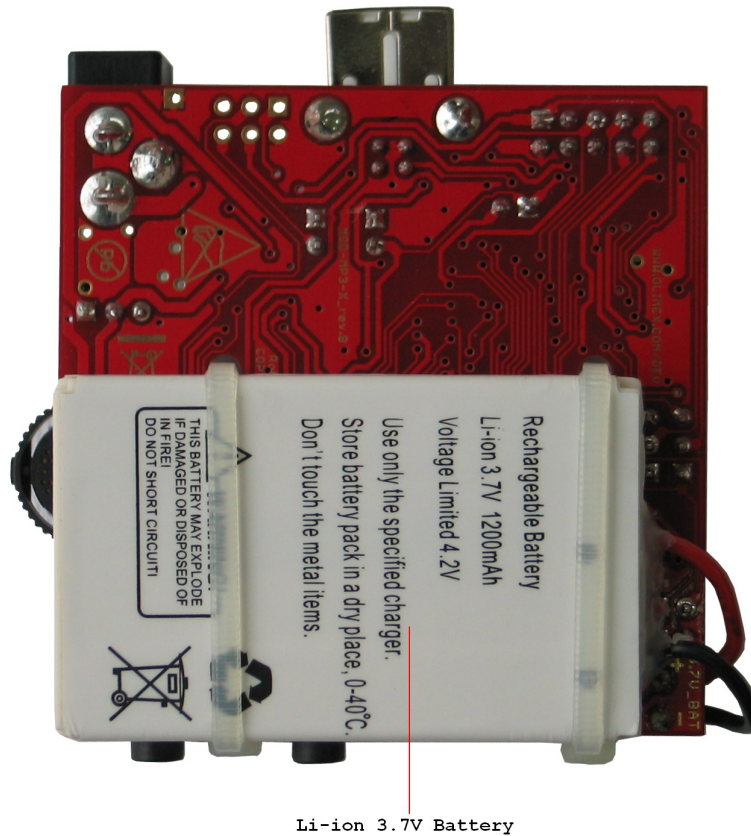

POWER SUPPLY CIRCUIT:

MOD-MP3-X is typically power supplied with 5 VDC.

The programmed board power consumption is about 70 mA with all peripherals enabled.

RESET CIRCUIT:

MOD-MP3-X reset circuit for VS1053 includes RC group - R7 (100k Ω) pull-up and C12 (100nF), jumper MP3_RST, jumper VLS_RST, STM32F103RBT6 pin 43 (PA10/USART1_RX/TIM1_CH3) and VS1053 pin 3 (XRESET).

Note, that if VLS_RST jumper is closed, STM32F103RBT6 must not control the VS1053 RESET, because VLS_RST is connected to ground.

MOD-MP3-X reset circuit for STM32F103RBT6 includes R36 (10k Ω) pull-up, STM_RST jumper, SWD pin 10 and STM32F103RBT6 pin 7 (NRST).

CLOCK CIRCUIT:

Quartz crystal **Q1** (12.288 MHz) is connected to VS1053 pin 17 (XTALO) and pin 18 (XTALI).

Quartz crystal **Q2** (8 MHz) is connected to STM32F103RBT6 pin 5 (PD0/OSC_IN) and pin 6 (PD1/OSC_OUT).

JUMPER DESCRIPTION:

UEXT/BAT



When this jumper is shorted in position UEXT - the board is power supplied via UEXT. When this jumper is shorted in position BAT - the board is power supplied via BATTERY, USB or external power supply.
Default state is shorted in position BAT.

BOOT_E



When this jumper is closed, codec is able to boot firmware from EEPROM. This is for standalone mode.
Default state is closed.

SA_E



This jumper connects SPI2_MOSI signal with SPI1_SCK signal.
Default state is closed.

DREQ_E



This jumper connects SPI1_SCK signal with DREQ signal.
Default state is closed.

MP3_RST/TXD and DREQ/RXD



When these jumpers are shorted in position MP3_RST and DREQ, the codec is controlled direct via UEXT, without involving STM32F103RBT6. When these jumpers are shorted in position TXD and RXD - via the UART interface of UEXT may be submitted to STM32F103RBT6 commands to operate the codec.
Default states are shorted in positions MP3_RST and DREQ.

VLS_RST



When this jumper is closed, STM32F103RBT6 must not control the VS1053 RESET, because VLS_RST jumper connects VS1053 pin 3 (XRESET) to ground
Default state is opened.

STM_RST



When this jumper is closed, STM32F103RBT6 is in reset.
Default state is closed.

R-T



This jumper connects RST signal with TRST signal.
Default state is opened.

BCD



This jumper connects the battery charger input and output. When is closed the battery charger is disabled.
Default state is opened.

Jumpers description depending on mode:

Jumpers	Standalone mode	UEXT playback mode	UEXT smart control mode
UEXT/BAT	BAT	UEXT	BAT
BOOT_E	closed	opened	opened
SA_E	closed	opened	opened
DREQ_E	closed	opened	opened
MP3_RST/TXD	MP3_RST	MP3_RST	TXD
DREQ/RXD	DREQ	DREQ	RXD
STM_RST	closed	closed	opened
VLS_RST	opened	opened	opened

Jumpers description for changing EEPROM firmware:

-SA_E, BOOT_E and DREQ_E - opened

-STM_RST and VLS_RST - closed

-DREQ/RXD - closed in position DREQ

-MP3_RST/TXD - closed in position MP3_RST

-UEXT/BAT - closed in position BAT (position of this jumper depends on the source of power that you will choose)

In this jumper position you can program on board EEPROM with the proper programmer (for example PICKit2). Note that you have to make custom adapter cable between EEPROM programmer and EEPROM connector. See EEPROM connector description below.

Commands for UEXT smart control mode:

In this mode STM32F103RBT6 firmware has extra - Mass storage device, through which you can save MP3 files to the SD card.

In this mode you can use RXD and TXD signals of UEXT connector to communicate between MOD-MP3-X and your computer. For this purpose, for example, you can use our module MOD-USB-RS232, which creates a virtual COM Port. The COM Port setting are 9600bps 8N1.

You can also use other our boards with UEXT to connect with MOD-MP3-X.

It is the list of used commands:

Note: For the latest version visit our site: www.olimex.com/dev

- "L" - lists the current directory and return its contents, directories are marked with a <DIR> tag

- "CDIRNAME <name>" - switch the current directory to <name>, name should be up to 8 characters long

- "cnum <index>" - switch the current directory to the one with given <index>, as displayed with the "L" command
- "." - returns to the parent directory, no higher than the root directory
- "PSONGNAME <name>" - plays file in the current directory by its <name>, <name> should be in 8+3 format and the only extension supported is ".MP3"
- "pnum <num>" - plays file in the current directory by its <index>, starting from 0. <index> may be calculated by the sequence number displayed with the "L" command minus the number of directories in the current directory.
- "OFF" - turns the codec chip OFF, may be executed at any time
- "ON" - turns the codec chip ON, may be executed at any time

These commands have meaning only when playback is started:

- "C" - stop playing current file, returns "Stopped."
- "+" - increase volume by 0.5dB step, 0 refers to max volume value, 254 is minimal value.
- "-" - decrease volume by 0.5dB step, 0 refers to max volume value, 254 is minimal value.
- "p" - play/pause toggle during playback, returns "Paused"/"Playing" respectively.
- "?" - display information on supported commands.

*Note: All of the commands should be followed by a newline character ('\n' or '\r\n')!

INPUT/OUTPUT:

Status Led (green) with name **STAT1**, connected to STM32F103RBT6 pin 2 (PC13/ANTI_TAMP).

Meaning of the status LED (STAT1) activity:

- When in mass storage mode the LED indicates SD card read/write activity.
- When playing a file in MP3 player mode LED is constantly ON.
- When playback is paused in MP3 player mode LED is blinking with 0.5Hz period.

Battery level status Led (yellow) with name **STAT2**, connected to STM32F103RBT6 pin 3 (PC14/OSC32_IN).

Battery level status LED (STAT2) activity:

- When powered by the battery the MOD-MP3-X indicated low battery level. If voltage of the battery falls below 3.3V then the STAT2 LED starts to blink.
- If an external power source is connected, then battery starts charging. In this case STAT2 LED is constantly lit while battery is charging and turns off when battery is fully charged.

Power-on led (red) with name **LED** is used by VS1053 firmware and is connected to STM32F103RBT6 pin 36 (SPI2_MOSI).

Wake-up button, connected to STM32F103RBT6 pin 14 (PA0-WKUP).

Switch with name **Joystick** with three positions: SW1, SW2 and SW3.

Position	Short Keypress	Long Keypress
SW1 (to power jack)	Next Song	Volume up
SW2 (to headphones)	Previous Song	Volume down
SW3 (pressed)	Pause/Play	-

EXTERNAL CONNECTORS DESCRIPTION:

PWR JACK:

Pin #	Signal Name
1	Power Input
2	GND

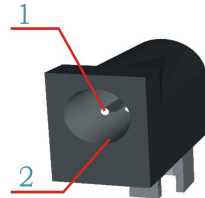

UEXT:

Pin #	Signal Name
1	+3.3V_UEXT
2	GND
3	DREQ/RXD
4	MP3_RST/TXD
5	XCS
6	SW-CS1
7	SPI1_MISO
8	SPI1_MOSI
9	SPI1_SCK
10	DCS

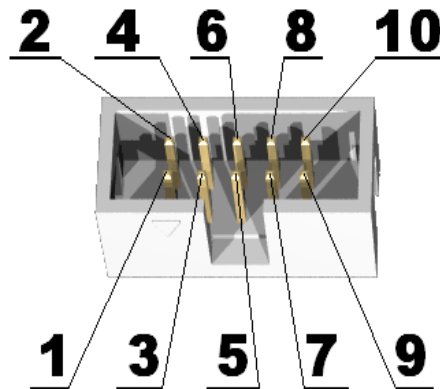

SWD:

Pin #	Signal Name
1	VCC (3.3V)
2	TMS/SWD
3	GND
4	TCK/SWCLK
5	GND
6	TDO
7	CUT (NC)
8	TDI
9	GND
10	RST

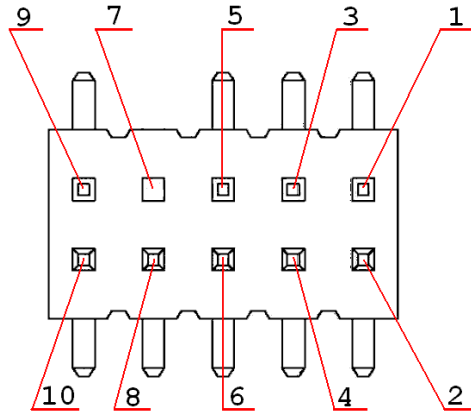

USB:

Pin #	Signal Name
1	USB_DETECT
2	USBDM
3	USBDP
4	GND

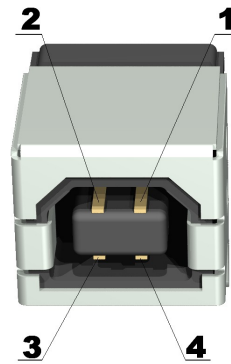

MIC:

Pin #	Signal Name
1	MICN
2	MICP/LINE1
3	MICP/LINE1

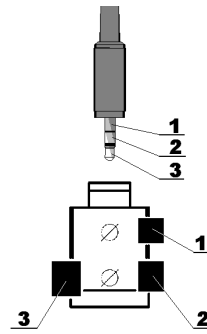

HEADPHONE:

Pin #	Signal Name
1	GBUF
2	RIGHT
3	LEFT

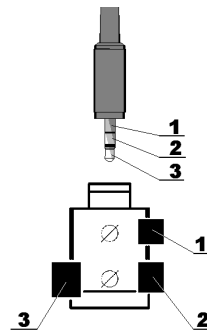

SD/MMC:

Pin #	Signal Name
1	MCIDAT2
2	SPI2_NSS
3	SPI2_MOSI
4	VCC
5	SPI2_SCK
6	GND
7	SPI2_MISO
8	MCIDAT1
9	Not Connected
10	Not Connected
11	Not Connected
12	Not Connected

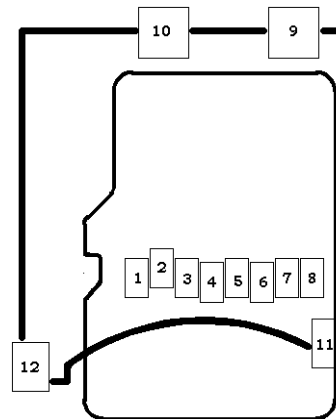

EEPGM:

Pin #	Signal Name
1	VCC
2	GND
3	SPI2_MISO
4	SPI2_MOSI
5	SPI2_NSS
6	Via BOOT_E to SW-CS1

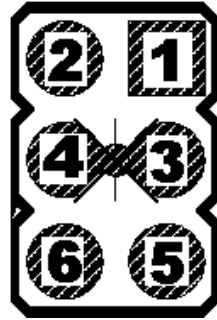

MECHANICAL DIMENSIONS:

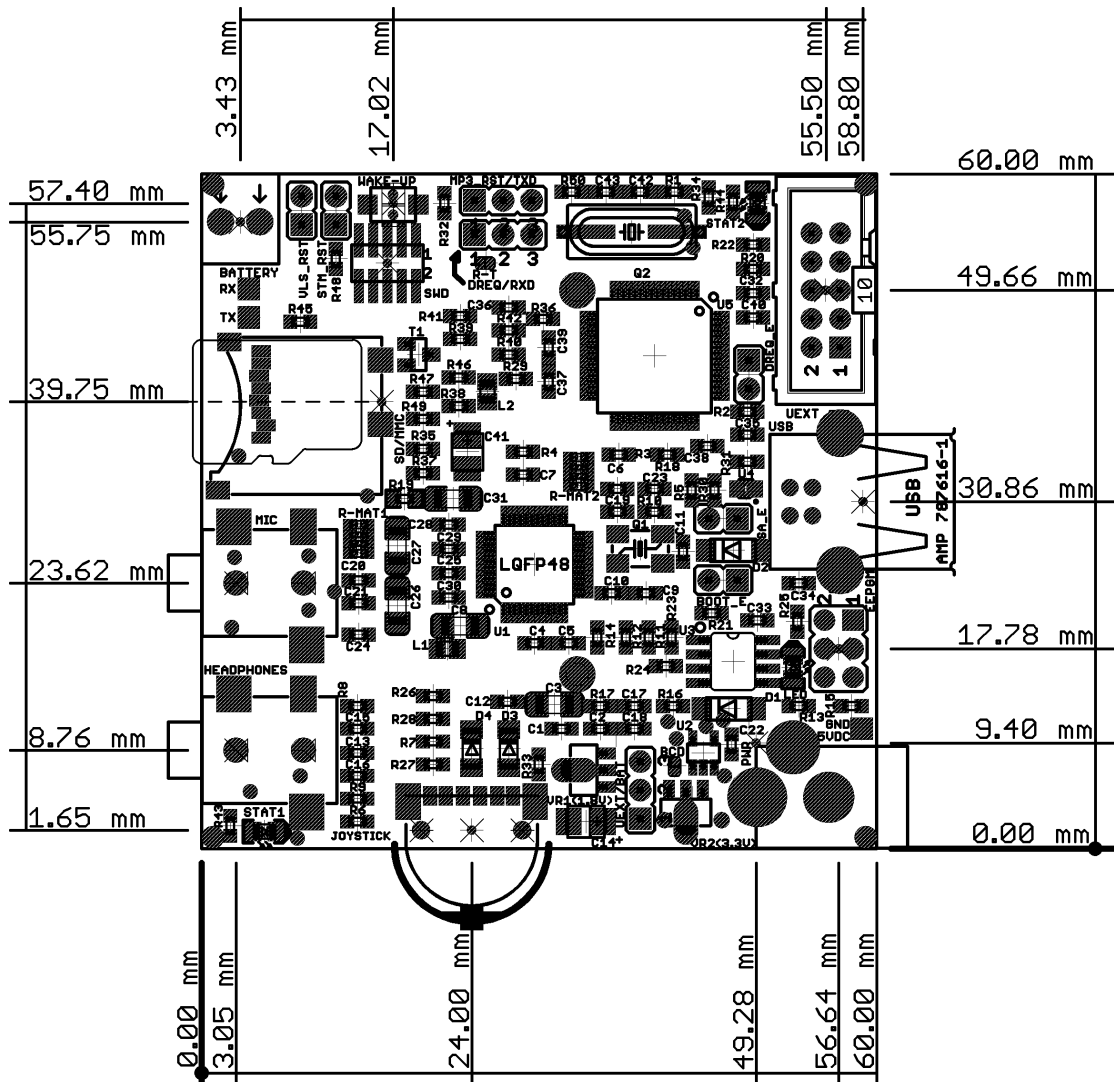

AVAILABLE DEMO SOFTWARE:

- MOD-MP3-X-Demo

ORDER CODE:

MOD-MP3-X - assembled and tested board

How to order?

You can order to us directly or by any of our distributors.
Check our web www.olimex.com/dev for more info.

Revision history:

Revision B, January 2011

Disclaimer:

© 2011 Olimex Ltd. All rights reserved. Olimex®, logo and combinations thereof, are registered trademarks of Olimex Ltd. Other terms and product names may be trademarks of others.

The information in this document is provided in connection with Olimex products. No license, express or implied or otherwise, to any intellectual property right is granted by this document or in connection with the sale of Olimex products.

Neither the whole nor any part of the information contained in or the product described in this document may be adapted or reproduced in any material from except with the prior written permission of the copyright holder.

The product described in this document is subject to continuous development and improvements. All particulars of the product and its use contained in this document are given by OLIMEX in good faith.

However all warranties implied or expressed including but not limited to implied warranties of merchantability or fitness for purpose are excluded.

This document is intended only to assist the reader in the use of the product. OLIMEX Ltd. shall not be liable for any loss or damage arising from the use of any information in this document or any error or omission in such information or any incorrect use of the product.