

More Precision.



optris® CT

Precise noncontact temperature measurement
from -40 to 900°C



FEATURES

- One of the smallest infrared sensors worldwide with 20:1 optical resolution
- Rugged and usable up to 180°C ambient temperature without cooling
- Separate electronics with easy accessible programming keys and LCD backlit display
- Optional analog output: 0/4-20 mA, 0-10 V, thermocouple type K or J
- Optional USB, RS485, RS232 interface or two relay outputs (optically isolated)
- Installation of up to 32 sensing heads

General specifications	
Environmental rating	IP 65 (NEMA-4)
Ambient temperature	sensing head: -20 - 180°C (130°C with 2:1)
	electronics: 0 - 65°C
Storage temperature	sensing head: -40 - 180°C (130°C with 2:1)
	electronics: -40 - 85°C
Relative humidity	10 - 95 %, non condensing
Vibration (sensor)	IEC 68-2-6: 3 G, 11-200 Hz, any axis
Shock (sensor)	IEC 68-2-27: 50 G, 11 ms, any axis
Weight	sensing head 40 g
	electronics 420 g
Electrical specifications	
Outputs/analog	channel 1: 0/4 - 20 mA, 0 - 5/10 V, thermocouple J, K
	channel 2: sensing head temperature (-20 - 180°C as 0 - 5 V or 0 - 10 V), alarm output
Optional:	relay: 2 x 60 V DC/42 V AC _{eff} ; 0.4 A; optically isolated
Outputs/digital (optional)	USB, RS232, RS485 (optional)
Output impedances	mA max. 500 Ω (with 8 - 36 V DC)
	mV min. 100 kΩ load impedance
	thermocouple 20 Ω
Inputs	programmable functional inputs for external emissivity adjustment, ambient temperature compensation, trigger (reset of hold functions)
Cable length	1 m (standard), 3 m, 8 m, 15 m
Current draw	max. 100 mA
Power supply	8 - 36 V DC

Measurement specifications	
Temperature range (scalable via programming keys or software)	-40 - 900°C (20:1)
	-40 - 600°C (15:1)
	-40 - 600°C (2:1)
Spectral range	8 - 14 μm
Optical resolution	20:1 (precision glass optics)
	15:1 (precision glass optics)
	2:1 (with flat front window)
CF-lens (optional)	0.6 mm@10 mm (with 20:1)
	0.8 mm@10 mm (with 15:1)
	2.5 mm@23 mm (with 2:1)
System accuracy (at ambient temperature 23 ±5°C)	±1 % or ±1°C ¹
Repeatability (at ambient temperature 23 ±5°C)	±0.5 % or ±0.5°C ¹
Temperature coefficient	0.05 % or 0.05°C/K ^{1,2}
Temperature resolution	0.1°C
Response time	150 ms (95 %)
Emissivity/Gain (adjustable via programming keys or software)	0.100 - 1.100
Transmissivity/Gain (adjustable via programming keys or software)	0.100 - 1.100
Signal processing (parameter adjustable via programming keys or software, respectively)	peak hold, valley hold, average; extended hold function with threshold and hysteresis
Certificate of calibration	optional

¹ whichever is greater

² at sensing head temperature 0 - 180°C (130°C with 2:1)

optris® CT

Optical specifications

20:1 optics

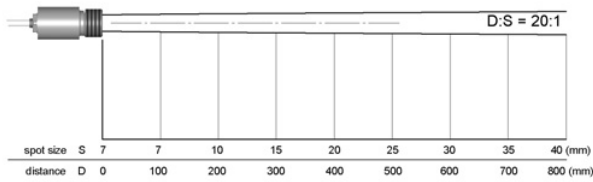

20:1 optics with CF-lens

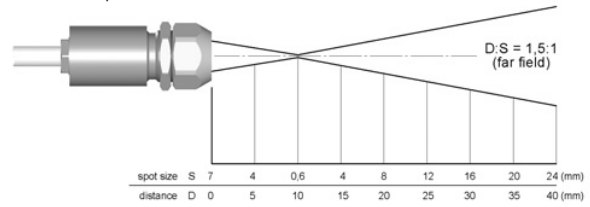

15:1 optics

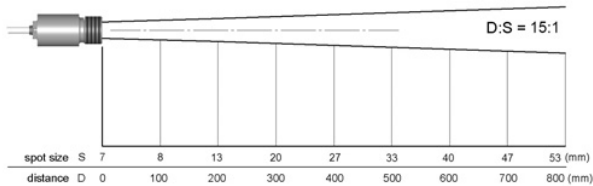

15:1 optics with CF-lens

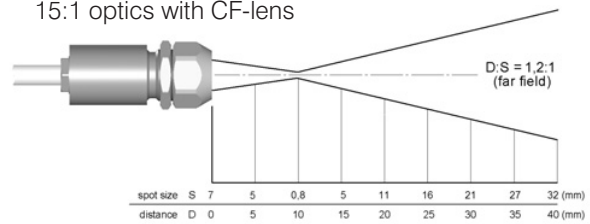

2:1 optics

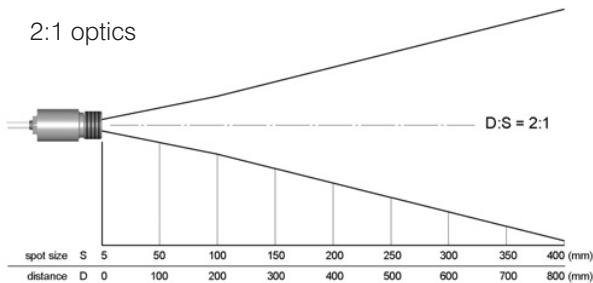

2:1 optics with CF-lens

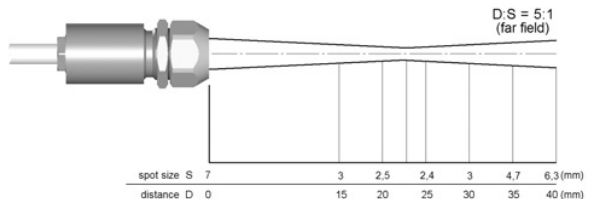

Dimensions

Sensing head

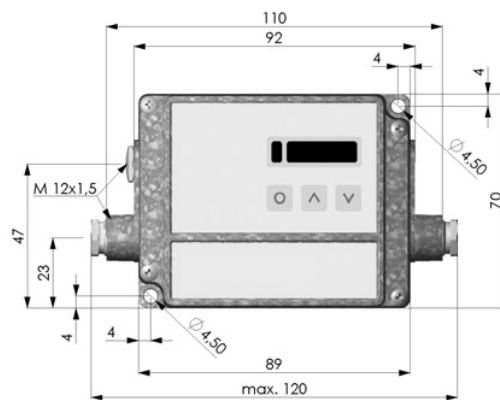
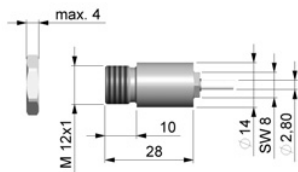

Electronics

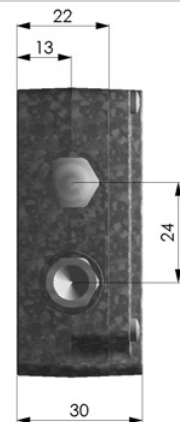

CTconnect - software

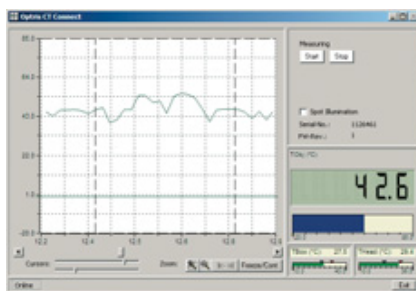

- easy sensor setup and remote controlling
- automatic data logging for analysis and documentation
- graphic display of temperature trends
- adjustment of extended signal processing functions
- programming of analog and digital input for external emissivity and ambient temperature compensation
- programming of alarm output (head or object temperature)
- digital remote communication of up to 32 sensors in one network

Optris GmbH

Strasse 49, Nr. 14
13127 Berlin/Germany
Tel.: +49 (0) 30 500 197-0
Fax: +49 (0) 30 500 197-10

info@optris.de
www.optris.de

A member of the micro-epsilon group.

Specifications are subject to change without notice.
CT-DS-E2005-06-C

