

## 1A/10A Current Clamp Set

### Instruction Sheet

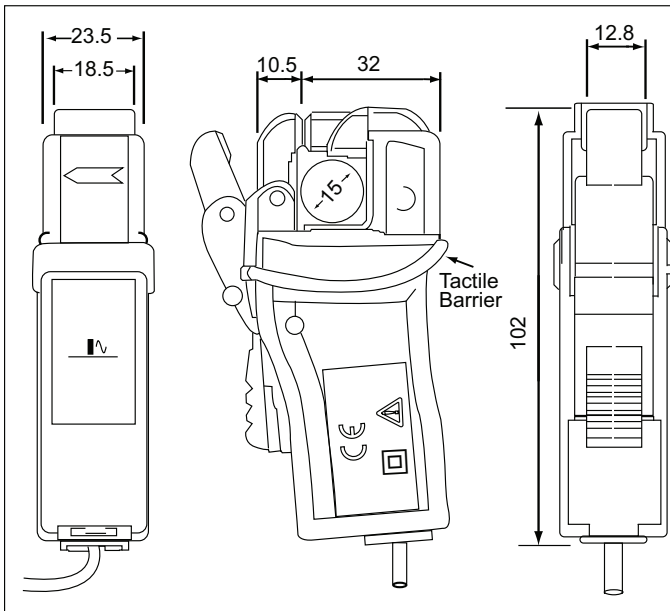

#### LIMITED WARRANTY AND LIMITATION OF LIABILITY

This Fluke product will be free from defects in material and workmanship for one year from the date of purchase. This warranty does not cover fuses, disposable batteries, or damage from accident, neglect, misuse, alteration, contamination, or abnormal conditions of operation or handling. Resellers are not authorized to extend any other warranty on Fluke's behalf. To obtain service during the warranty period, contact your nearest Fluke authorized service center to obtain return authorization information, then send the product to that Service Center with a description of the problem.

THIS WARRANTY IS YOUR ONLY REMEDY. NO OTHER WARRANTIES, SUCH AS FITNESS FOR A PARTICULAR PURPOSE, ARE EXPRESSED OR IMPLIED. FLUKE IS NOT LIABLE FOR ANY SPECIAL, INDIRECT, INCIDENTAL OR CONSEQUENTIAL DAMAGES OR LOSSES, ARISING FROM ANY CAUSE OR THEORY. Since some states or countries do not allow the exclusion or limitation of an implied warranty or of incidental or consequential damages, this limitation of liability may not apply to you.

Fluke Corporation  
P.O. Box 9090  
Everett, WA 98206-9090  
U.S.A.

Fluke Europe B.V.  
P.O. Box 1186  
5602 BD Eindhoven  
The Netherlands

11/99

#### Introduction

The 1A/10A Current Clamp Sets (the Clamp) have been designed for applications with Fluke 1735 and 1740 series products for accurate non-intrusive measurement of ac currents. Using latest technologies (integrated memory for calibration data) provides current ranges from 0.025 A up to 10 A in a frequency range of 40 Hz to 5 kHz.

#### Contacting Fluke

To contact Fluke, call one of the following telephone numbers:

USA: 1-888-44-FLUKE (1-888-443-5853)

Canada: 1-800-36-FLUKE (1-800-363-5853)

Europe: +31 402-675-200

Japan: +81-3-3434-0181

Singapore: +65-738-5655

Anywhere in the world: +1-425-446-5500

USA Service: 1-888-99-FLUKE (1-888-993-5853)

Or, visit Fluke's Web site at [www.fluke.com](http://www.fluke.com).

To register your product, visit <http://register.fluke.com>

#### Safety Instructions

Please read this section carefully. It will familiarize you with the most important safety instructions for handling the Probe. In this instruction sheet, a Warning identifies conditions and actions that pose hazard(s) to the user. A Caution identifies conditions and actions that may damage the calibrator or the test instruments.

#### Warning

**The Clamp may only be used and handled by qualified personnel. To avoid personal injury, follow these precautions:**

- To avoid electric shock, use caution during installation; high voltages and currents may be present in circuit under test.
- Do not use the Clamp if damaged. Always connect to display device before it is installed around the conductor.
- Use the Clamp only as specified in the operating instructions; otherwise the safety features may not protect you.
- Adhere to local and national safety codes. Individual protective equipment must be used to prevent the shock and arc blast injury where hazardous live conductors are exposed.
- Before each use, inspect the Clamp. Look for cracks or missing portions of the housing or output cable insulation. Also look for loose or weakened components.

PN 3373012

November 2008

©2008 Fluke Corporation, All rights reserved. Printed in The Netherlands. Specifications are subject to change without notice. All product names are trademarks of their respective companies.

- Use caution when working with voltages above 60 V dc, 30 V ac rms or 42 V ac peak. Such voltages pose a shock hazard.
- This Clamp is considered to be used in 600 CAT III environments. CAT III equipment is designed to be used in distribution panels, feeders and short branch circuit, and the lighting system in large buildings.
- Do not use the Clamp in damp or wet environments or in locations that hazardous gases exist.
- Do not hold the Current Clamp anywhere beyond the tactile barrier.
- De-energize circuit during installation and removal of Probe.







### Operating Instructions

1. Connect the Clamp to the current input jack of the product. Verify that the product has recognized that a current Clamp is connected.
2. In case of uninsulated conductors, de-energize the circuit before placing the Clamp. Re-energize the circuit.
3. Observe and take measurements as required. Positive output indicates that the current flow is in the direction shown by the arrow on the Clamp.
4. In case of uninsulated conductors, de-energize before removal of the Clamp.

### Cleaning

Clean the Probe periodically by wiping it with a damp cloth and detergent. Do not use abrasive cleaners or solvents. Do not immerse the Probe in liquids.

### Symbols

	Do not dispose of this product as unsorted municipal waste. Go to Fluke's website for recycling information.
	Risk of Danger. Important Information. See manual.
	Hazardous Voltage. Risk of electric shock.
	Double insulation.
	Do not apply around or remove from HAZARDOUS LIVE conductors.
	Conforms to relevant Canadian Standards Association directives.
	Conforms to relevant European Union directives.

### Electrical Characteristics

**Nominal current In:** 1 / 10 A ac rms

**Overload:** up to 13 A rms.

**Max. Non-destructive current:** 100 A ac rms

**Conductor position influence:** <0.5 % of range at 50/60 Hz

**Error due to adjacent conductor:** ≤15 mA / A at 50 Hz

**Phase shift at 2 kHz at 10 A:** < ±1 degree

**Frequency range:** 40 Hz to 5 kHz (-3 dB)

**Temperature coefficient:** 0.015 % of range / °C

**Working voltage (see section safety):** 600 V ac rms or dc

**Order reference:**

**3-phase 3024413:** 11A/10A CLAMP PQ3

**3-phase+N 3024424:** 11A/10A CLAMP PQ4

## Specifications

### General Specifications

**Maximum Conductor Size:** 15 mm (0.59 in) diameter bus bar  
15 x 17 mm (0.59 x 0.66 in)

**Cable length:** 2 m (6.56 ft)

**Length of measuring head:** 122 cm (4 ft)

**Operating temperature range:** -10 °C to +55 °C  
(14 °F to 131 °F)

**Storage temperature range:** -20 °C to +70 °C  
(-4 °F to 158 °F)

**Operating humidity (non-condensing):** 15 % to 85 % rh

**Weight:** PQ4 730 g (1.6 lb); PQ3 560 g (1.25 lb)

### Reference Conditions

**Environment temperature range:** +18 °C to +26 °C  
(64.4 °F to 78.8 °F)

**Humidity:** 20 to 75 % rh

**Altitude:** max. 2000 m (1.24 mi)

**Current:** sinusoidal waveform, 48 Hz to 65 Hz, distortion factor: <1 %, no dc component

**Load impedance for voltage output:** ≥1 MΩ, <100 pF

### Safety Standards

IEC/EN61010-1: 2001

IEC/EN61010-2-032:2002

IEC/EN61010-031:2002

### Safety Specifications

**Category Rating:** 600 V CAT III, pollution degree 2

**EMC Standards:** IEC/EN 61326-1:2006

### Measurement Considerations

Observe the following guidelines when making measurements:

- Center the conductor inside the Clamp jaw.
- Make sure the Clamp is perpendicular to the conductor.
- For optimal reading, make sure the conductor is positioned between the alignment marks on the jaws of the Clamp.
- Avoid taking measurements close to other current-carrying conductors.

### Accuracy (at 50 Hz)

Primary current	0.025 A to 0.5 A	0.5 A to 2.5 A	2.5 A to 5 A	5 A to 10 A
Operating error in % of reading	±2.5 %	±1.5 %	±0.5 %	±0.5 %
Phase shift	Not specified	<2 °	<0.5 °	<1 °