

“Mini” SiSonic™ Microphone Specification with MAX RF Protection – *Halogen Free*

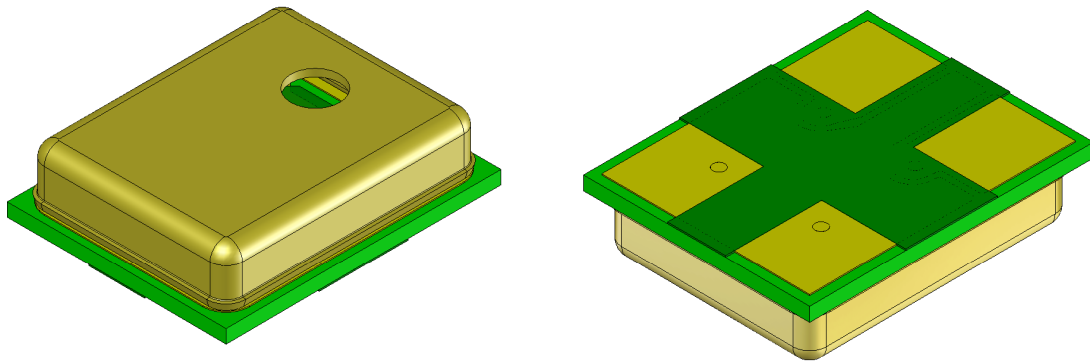

Knowles Acoustics
1151 Maplewood Drive
Itasca, IL 60143

1. DESCRIPTION AND APPLICATION

1.1 Description

“Mini” Surface Mount Silicon Microphone
with MAX RF Protection – Halogen Free

1.2 Application

Hand held telecommunication devices

2. PART MARKING

Identification Number Convention

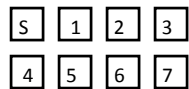

S: Manufacturing Location

“S” – Knowles Electronics Suzhou
Suzhou, China

“No Alpha Character” – Knowles Electronics Itasca
Itasca, IL USA

“E” – Engineering Samples

Digits 1 – 7: Job Identification Number

3. TEMPERATURE RANGE

3.1 Operating Temperature Range: -40°C to +100°C

3.2 Storage Temperature Range: -40°C to +100°C

4. ACOUSTIC & ELECTRICAL SPECIFICATIONS

	Symbol	Condition	Limits			Unit
			Min.	Nom.	Max.	
Directivity		Omni-directional				
Sensitivity	S	@ 1kHz (0dB=1V/Pa)	-45	-42	-39	dB
Output impedance	Z _{OUT}	@ 1kHz (0dB=1V/Pa)	---	---	400	Ω
Current Consumption	I _{DSS}	across 1.5 to 3.6 volts	---	---	250	μA
Signal to Noise Ratio	S/N	@ 1kHz (0dB=1V/Pa)	---	59	---	dB
Supply Voltage	V _S		1.5	---	3.6	V
Sensitivity Loss across Voltage		Change in sensitivity over 3.6v to 1.5v	No Change Across Voltage Range			dB
THD		At 100dB SPL, THD < 1% At 115dB SPL, THD < 10%				dB

5. FREQUENCY RESPONSE CURVE

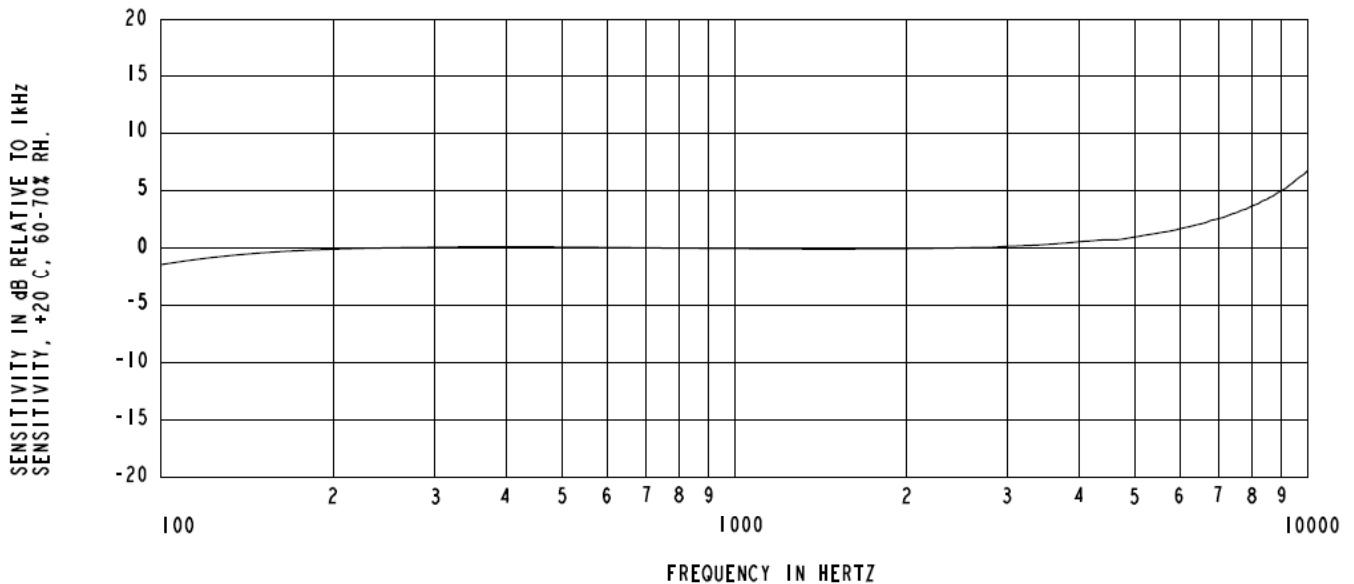

6. MECHANICAL SPECIFICATIONS

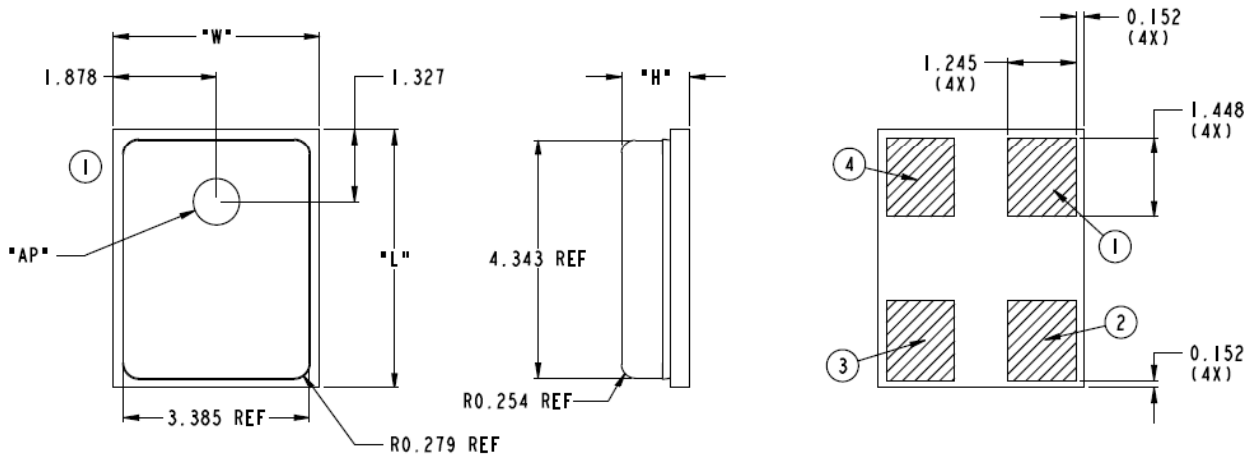

ITEM	DIMENSION	TOLERANCE	UNITS
HEIGHT (H)	1.250	±0.100	mm
LENGTH (L)	4.724	±0.100	mm
WIDTH (W)	3.759	±0.100	mm
ACOUSTIC PORT (AP)	0.840	±0.100	mm

PIN OUTPUT	
PIN #	FUNCTION
1	OUTPUT
2	GROUND
3	GROUND
4	POWER (V _{dd})

NOTES:

1. DIMENSIONS IN MILLIMETERS UNLESS OTHERWISE SPECIFIED.
2. TOLERANCE ±0.15mm UNLESS OTHERWISE SPECIFIED.

7. RECOMMENDED CUSTOMER LAND PATTERN

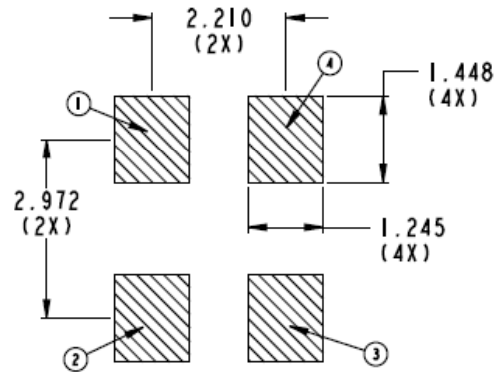

8. RECOMMENDED SOLDER STENCIL PATTERN

N/A

9. RECOMMENDED INTERFACE CIRCUIT

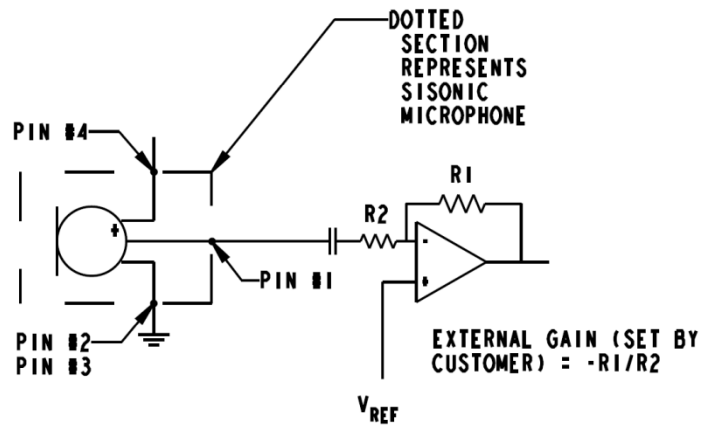

10. PACKAGING DETAIL

ITEM	DIMENSION (MM [INCH])	TOLERANCE (MM [INCH])
A ₀	4.20	±0.10
B ₀	5.10	±0.10
K ₀	1.57	±0.10
L _P	8.00	±0.10
L _S	4.00	±0.20 OVER 10 HOLES
L ₀	2.00	±0.05
W _T	12.00	±0.30
W _P	5.50	±0.05
W _S	1.75	±0.10
T	0.30	±0.05
D _P	∅1.50	±0.10
D _S	∅1.50	+0.10/-0
R _P	R0.20	+0/-0.20
R _C	R0.30	±0.05

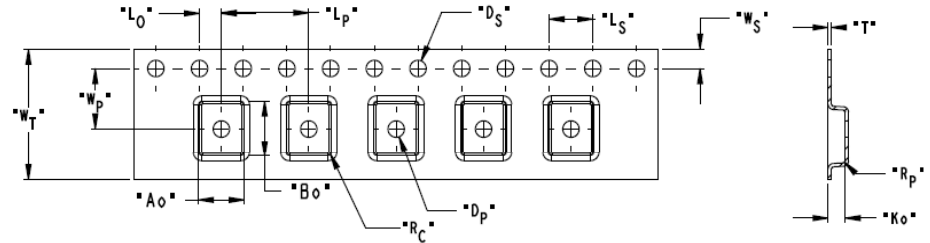

COMPONENT ORIENTATION

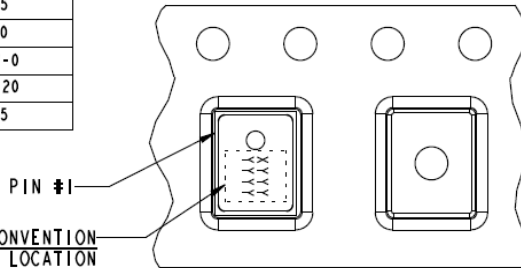

TRACKING NUMBER CONVENTION

X = MANUFACTURING LOCATION
(ALPHA CHARACTER)
Y = JOB IDENTIFICATION
NUMBER (JIN)
(NUMERIC CHARACTER)
MANUFACTURING LOCATION
S = SUZHOU, CHINA
E = ENGINEERING SAMPLES

MODEL NUMBER	SUFFIX	REEL DIAMETER	QUANTITY PER REEL
SPM0410HR5H-PB	-2	7"	1,200
SPM0410HR5H-PB	-6	13"	4,800

TAPE & REEL	PER EIA-481
LABEL	LABEL APPLIED TO EXTERNAL PACKAGE AND DIRECT TO REEL.

11. SOLDER REFLOW PROFILE

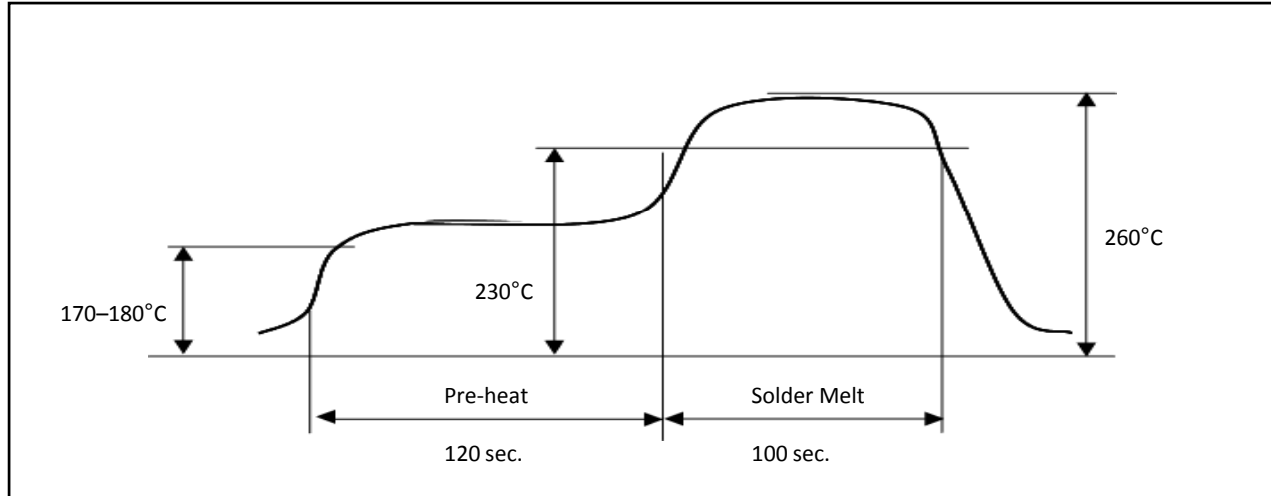

<u>Stage</u>	<u>Temperature Profile</u>	<u>Time (maximum)</u>
Pre-heat	170 ~ 180 C	120 sec.
Solder Melt	Above 230 C	100 sec.
Peak	260 C maximum	30 sec.

Notes:

1. Do not pull a vacuum over the port hole of the microphone. Pulling a vacuum over the port hole can damage the device.
2. Do not board wash after the reflow process. Board washing and cleaning agents can damage the device. Do not expose to ultrasonic processing or cleaning.
3. Number of Reflow = recommend no more than 3 cycles.

12. ADDITIONAL NOTES

- (A) Shelf life: Twelve (12) months when devices are to be stored in factory supplied, unopened ESD moisture sensitive bag under maximum environmental conditions of 30°C, 70% R.H.
- (B) MSL (moisture sensitivity level) Class 2a.

13. RELIABILITY SPECIFICATIONS

Note: After test conditions are performed, the sensitivity of the microphone shall not deviate more than 3dB from its initial value.

Test	Description
Thermal Shock	100 cycles of air-air thermal shock from -40C to +125C with 15min soaks. (ICE 68-2-4)
High Temperature Storage	+105C environment for 1,000 hours. (IEC 68-2-2 Test Ba)
Low Temperature Storage	-40C environment for 1,000 hours. (IEC 68-2-2 Test Aa)
High Temperature Bias	+105C environment while under bias for 1,000 hours. (IEC 68-2-2 Test Ba)
Low Temperature Bias	-40C environment while under bias for 1,000 hours. (IEC 68-2-2 Test Aa)
Temperature / Humidity Bias	+85C/85% RH environment while under bias for 500 hours. (JESD22-A101A-B)
Vibration	4 cycles lasting 12 minutes from 20 to 2,000Hz in X, Y, and Z direction with a peak acceleration of 20g. (MIL 883E, Method 2007.2, A)
Electrostatic Discharge	3 discharges at +/- 8kV direct contact to the lid when unit is grounded (IEC 61000-4-2) and 3 discharges at +/- 2kV direct contact to the I/O pins (MIL 883E, Method 3015.7)
Reflow	5 reflow cycles with peak temperature of 260C.
Mechanical Shock	3 pulses of 10,000g in the X, Y, and Z direction. (IEC 68-2-27, Test Ea)

14. SPECIFICATION REVISIONS

Revision	Detailed Specification Changes	Date
X1	Preliminary Specification Release	08-11-2008
A	Specification Release	09-29-2008
B	Update to new format, metal can dimensions for reference, update T&R notes, update packaging notes, update reliability notes, update current consumption minimum	01-28-2009
C	Updated mechanical view with three place precision to eliminate rounding error (B)	02-17-2009
D	Typographical error corrected; output impedance value 400ohms (B)	03-31-2009

The information contained in this literature is based on our experience to date and is believed to be reliable and it is subject to change without notice. It is intended as a guide for use by persons having technical skill at their own discretion and risk. We do not guarantee favorable results or assume any liability in connection with its use. Dimensions contained herein are for reference purposes only. For specific dimensional requirements consult factory. This publication is not to be taken as a license to operate under, or recommendation to infringe any existing patents. This supersedes and voids all previous literature.