

NO.	DESCRIPTION	PART NO.	QTY	MATERIAL	DRW NO.	REMARKS
-----	-------------	----------	-----	----------	---------	---------

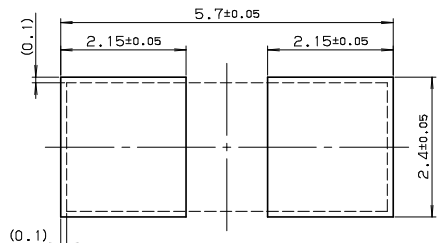

推奨パターンレイアウト
RECOMMENDED PATTERN LAYOUT

シールドロック斜視図
SHIELD LOCK

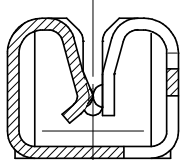
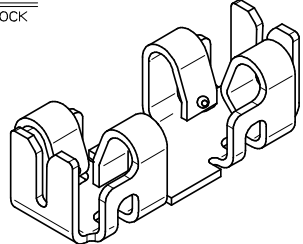

SECT. A-A
(s=20/1)

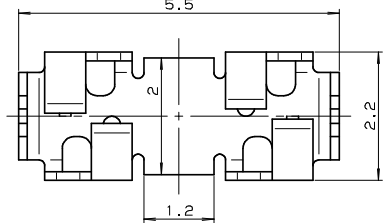

シールドロック嵌合状態斜視図
SHIELD LOCK MATING

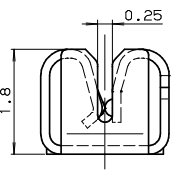
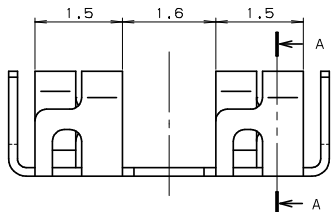
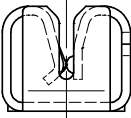
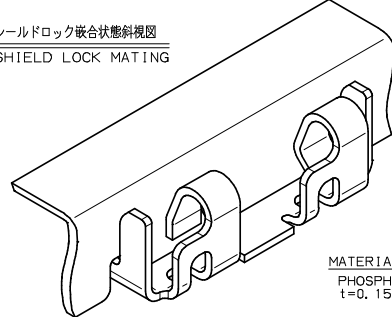

MATERIAL
PHOSPHOR BRONZE
t=0.15mm

PLATING
AFTER-PLATING
Sn-PLATING

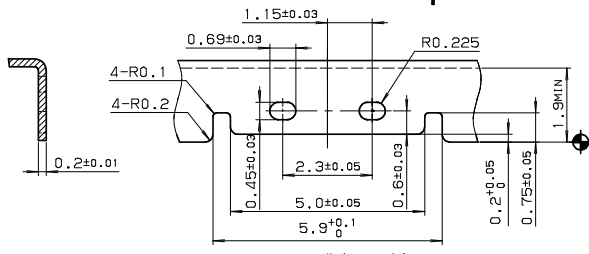

シールドケース形状 (S=10/1)
SHIELDING CASE FORM

TOLERANCE / 公差 (S)		PRODUCT SPEC / 製品規格							
X < 10	±0.2	UNIT	ANGLE	EDN-458	7-19-01				
10 ≤ X < 30	±0.25	mm	3RD	NO. EDN/DCN	DATE	ISSUE	CHECKED	APPROVED	
30 ≤ X	±0.3			PART NAME / 品名					
ANGLE / 角度	±3°	SCALE	DATE	SERIES 8069 CONT					
		15/1	7-19-01	SHIELD LOCK (H=1.8)					
DRAWN	DESIGNED	CHECKED	APPROVED	PART NO. / 部品番号					
K. KAIHARA	K. KAIHARA			70 8069 000 100 800					
KYOCERA ELCO CORPORATION				DWG NO. / 図番		BJS 8069504		SHEET/REV	
								1/2 0	

8 7 6 5 4 3 2 1

NO.	DESCRIPTION	PART NO.	QTY	MATERIAL	DRW NO.	REMARKS
-----	-------------	----------	-----	----------	---------	---------

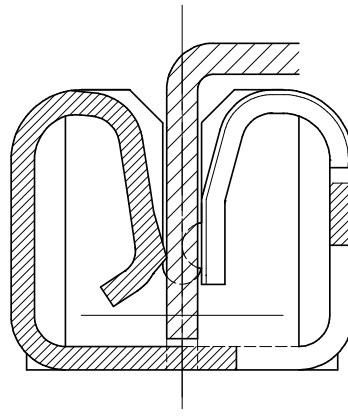
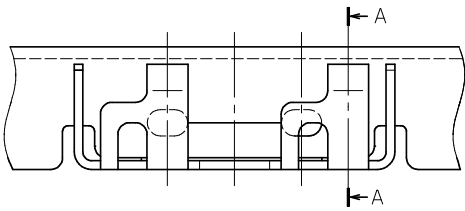

SECT. A-A

TOLERANCE / 公差 (S)		PRODUCT SPEC / 製品規格		REFER TO SHEET 1/2					
X < 10	±0.2	UNIT	ANGLE	NO.	EDN/DCN	DATE	ISSUE	CHECKED	APPROVED
10 ≤ X < 30	±0.25	mm	3RD	PART NAME / 品名					
30 ≤ X	±0.3	SCALE	DATE	SERIES 8069 CONT					
ANGLE / 角度 ±3°		N/S	7-19-01	SHIELD LOCK (H=1.8)					
DRAWN	DESIGNED	CHECKED	APPROVED	PART NO. / 部品					
K. KAIHARA	K. KAIHARA			70 8069 000 100 800					
KYOCERA ELCO CORPORATION				DWG NO. / 図番		SHEET/REV			
				BJS 8069504		2/2		0	

8

7

6

5

4

3

2

1

NO.	DESCRIPTION	PART NO.	QTY	MATERIAL	DRW NO.	REMARKS
1	SHIELD LOCK	70 8069 000 100 800	3000			
2	EMBOSSED TAPE		1	POLYSTYRENE (CLEAR)		
3	TOP COVER TAPE		1	POLYSTYRENE (CLEAR)		
4	REEL		1	CORRUGATED CARDBOARD		

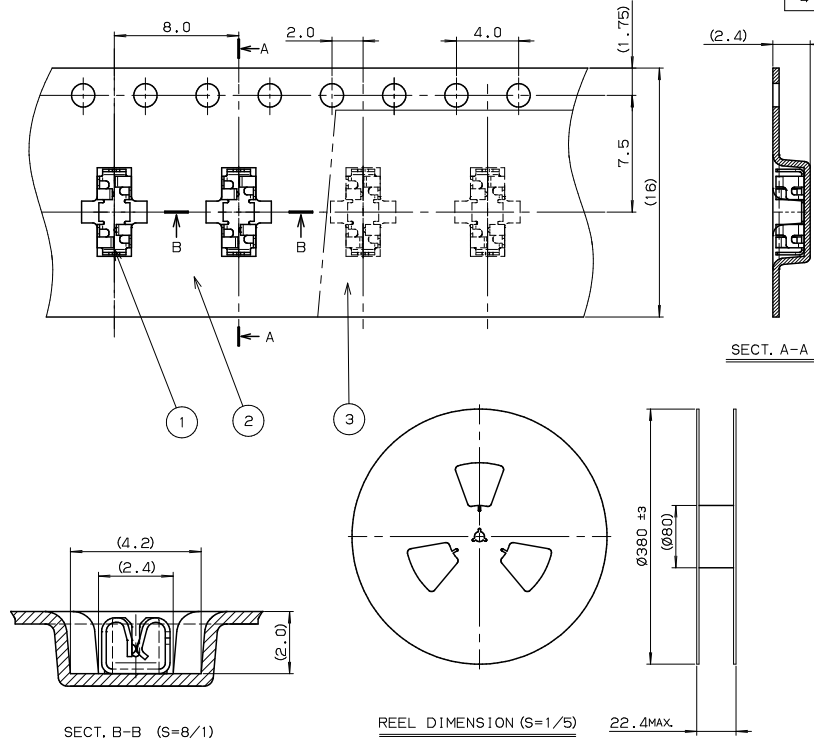

注 記 NOTE
 1. 納入数量 : 3000 個/reel
 QUANTITY : 3000 ea/reel
 2. 納入時のリール巻き方向
 REELING DIRECTION
 IN DELIVERY

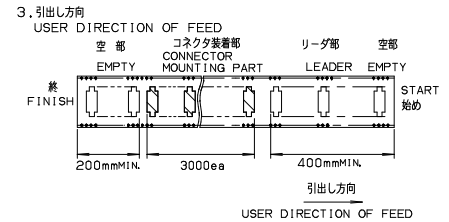
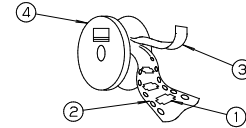

TOLERANCE / 公差 (S)		PRODUCT SPEC / 製品規格								
POLYSTYRENE (CLEAR)		POLYSTYRENE (CLEAR)								
±0.4 ±0.05		±0.4 ±0.05								
X < 10 ±0.2	UNIT	ANGLE	O EDN-484		7-30-01					
10 ≤ X < 30 ±0.25	mm	3RD	NO. EDN/DCN		DATE		ISSUE		CHECKED APPROVED	
30 ≤ X ±0.3			PART NAME / 品名		SERIES 8069 SHIELD LOCK TAPING		H=1.8			
ANGLE / 角度 ±3°	SCALE	DATE	DRAWN		DESIGNED		CHECKED		APPROVED	
	4 / 1	7-30-01	K. KAIHARA		K. KAIHARA					
			PART NO. / 部品番号		04 8069 000 100 800					
			DWG NO. / 図番		BJS 8069003				SHEET/REV	
			KYOCERA ELCO CORPORATION						1/1 0	

8 7 6 5 4 3 2 1