

EVALUATION KIT  
AVAILABLE

# MAXIM

## 1.2GHz VCO with Linear Modulation Input

MAX2754

### General Description

The MAX2754 self-contained, linear modulation, voltage-controlled oscillator (VCO) is intended for use in the 2.4GHz to 2.5GHz ISM band, particularly for FSK modulation systems that utilize a direct frequency-modulation transmit architecture. This device features a linear modulation input in addition to the standard frequency tuning input. The frequency tuning range of 1145MHz to 1250MHz (1/2 LO) also supports an IF up to 110MHz with low side LO. The VCO is based on Maxim's proprietary monolithic VCO technology, where all VCO components are integrated on-chip, including the varactor and inductor.

The MAX2754 linear modulation input offers a means to directly FM modulate the VCO with a constant modulation sensitivity over the tuning voltage input range. Typical frequency deviation is -500kHz/V which is linear to  $\pm 4\%$  over the guaranteed frequency limits. The tuning input voltage range is +0.4V to +2.4V and the oscillator frequency is factory adjusted to provide guaranteed limits. The oscillator signal is buffered by an output amplifier stage (internally matched to 50 $\Omega$ ) to provide higher output power and isolate the oscillator from load impedance variations.

The MAX2754 operates over a +2.7V to +5.5V supply range. This device also provides a digitally controlled shutdown mode to permit implementation of sophisticated power-supply management. In shutdown, the supply current is reduced to 0.2 $\mu$ A. Even when active, power consumption is a modest 41mW.

The MAX2754 is packaged in the miniature 8-pin  $\mu$ MAX to offer the world's smallest, complete 2.4GHz direct-modulation VCO solution.

### Applications

- HomeRF WLAN
- Bluetooth
- 2.4GHz Cordless Phones
- 2.4GHz Wireless Data Radios

### Pin Configuration

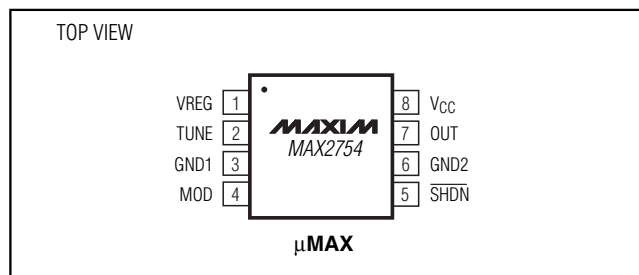

### Features

- ◆ Fully Monolithic VCO Construction with On-Chip Inductor and Varactor Tuning Elements
- ◆ Guaranteed 1145MHz to 1250MHz Tuning Range to Support 1/2 LO Applications
- ◆ Modulation Linearity Within  $\pm 4\%$
- ◆ Precise Modulation Gain (-500kHz/V)
- ◆ Low Phase Noise (-137dBc/Hz at 4MHz offset)
- ◆ +2.7V to +5.5V Single-Supply Operation
- ◆ Low-Current Shutdown Mode
- ◆ Miniature 8-Pin  $\mu$ MAX<sup>®</sup> Package

### Ordering Information

PART	TEMP RANGE	PIN-PACKAGE
MAX2754EUA	-40°C to +85°C	8 $\mu$ MAX

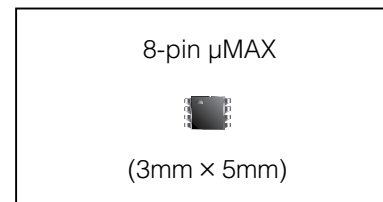

$\mu$ MAX is a registered trademark of Maxim Integrated Circuits, Inc.

### Typical Operating Circuit

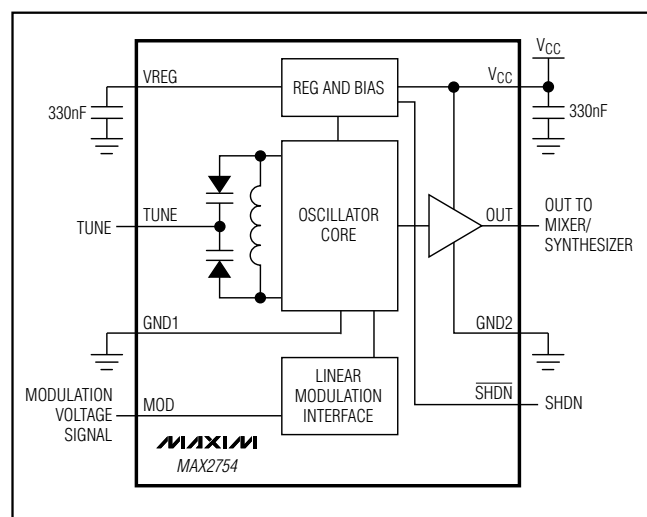

MAXIM

Maxim Integrated Products 1

For pricing, delivery, and ordering information, please contact Maxim/Dallas Direct! at 1-888-629-4642, or visit Maxim's website at [www.maxim-ic.com](http://www.maxim-ic.com).

# 1.2GHz VCO with Linear Modulation Input

## ABSOLUTE MAXIMUM RATINGS

V <sub>CC</sub> to GND .....	-0.3V to +6.0V
V <sub>REG</sub> to GND .....	-0.3V to +6.0V
TUNE, SHDN, MOD to GND .....	-0.3V to (V <sub>CC</sub> + 0.3V)
OUT to GND .....	-0.3V to +6.0V
Continuous Power Dissipation (T <sub>A</sub> = +70°C)	
8-Pin $\mu$ MAX (derate 5.7mW/°C above T <sub>A</sub> = +70°C) ...	457mW

Operating Temperature Range .....	-40°C to +85°C
Junction Temperature .....	+150°C
Storage Temperature Range .....	-65°C to +160°C
Lead Temperature (soldering, 10s) .....	+300°C

Stresses beyond those listed under "Absolute Maximum Ratings" may cause permanent damage to the device. These are stress ratings only, and functional operation of the device at these or any other conditions beyond those indicated in the operational sections of the specifications is not implied. Exposure to absolute maximum rating conditions for extended periods may affect device reliability.



CAUTION! ESD SENSITIVE DEVICE

## DC ELECTRICAL CHARACTERISTICS

(V<sub>CC</sub> = +2.7V to +5.5V, V<sub>TUNE</sub> = +0.4V to +2.4V, V<sub>SHDN</sub> ≥ +2.0V, V<sub>MOD</sub> = +1.4V, OUT is connected to a 50Ω load, T<sub>A</sub> = -40°C to +85°C. Typical values are at V<sub>CC</sub> = +3.0V, T<sub>A</sub> = +25°C, unless otherwise noted.) (Note 1)

PARAMETER	SYMBOL	CONDITIONS	MIN	TYP	MAX	UNITS
Supply Voltage	V <sub>CC</sub>		2.7		5.5	V
Supply Current	I <sub>CC</sub>	T <sub>A</sub> = +25°C, V <sub>SHDN</sub> ≥ 2.0V		13.7	19	mA
		T <sub>A</sub> = -40°C to +85°C, V <sub>SHDN</sub> ≥ 2.0V			20	
		V <sub>SHDN</sub> ≤ 0.6V	-2	0.2	2	μA
Digital Input Voltage High	V <sub>IH</sub>		2.0			V
Digital Input Voltage Low	V <sub>IL</sub>				0.6	V
Digital Input Current High	I <sub>IH</sub>	V <sub>SHDN</sub> ≥ 2.0V	-2		2	μA
Digital Input Current Low	I <sub>IL</sub>	V <sub>SHDN</sub> ≤ 0.6V	-1		1	μA
Modulation Input Voltage Range	V <sub>MOD</sub>		0.4		2.4	V
TUNE Leakage Current (Note 2)		V <sub>TUNE</sub> = +0.4V to +2.4V		0.01		nA

## AC ELECTRICAL CHARACTERISTICS

(MAX2754 EV kit. V<sub>CC</sub> = +2.7V to +5.5V, V<sub>TUNE</sub> = +0.4V to +2.4V, V<sub>SHDN</sub> ≥ +2.0V, V<sub>MOD</sub> = +1.4V, OUT is connected to a 50Ω load, T<sub>A</sub> = +25°C. Typical values are at V<sub>CC</sub> = +3.0V, T<sub>A</sub> = +25°C, unless otherwise noted.) (Note 1)

PARAMETER	SYMBOL	CONDITIONS	MIN	TYP	MAX	UNITS
Oscillator Guaranteed Frequency Limits	f <sub>MIN</sub> , f <sub>MAX</sub>	V <sub>TUNE</sub> = +0.4V to +2.4V, T <sub>A</sub> = -40°C to +85°C	1145		1250	MHz
Phase Noise		f <sub>OFFSET</sub> = 4MHz		-137		dBc/Hz
		Noise floor		-151		dBm/Hz
Tuning Gain		V <sub>TUNE</sub> at f <sub>MIN</sub>		124		MHz/V
		V <sub>TUNE</sub> at f <sub>MAX</sub>		81		
Output Power				-5		dBm
Modulation Peak Frequency Deviation		f <sub>MIN</sub> < f < f <sub>MAX</sub> (Note 2)	±400	±500	±600	kHz
Modulation Sensitivity		Common-mode V <sub>MOD</sub> = 1.4V		-500		kHz/V

# 1.2GHz VCO with Linear Modulation Input

MAX2754

## AC ELECTRICAL CHARACTERISTICS (continued)

(MAX2754 EV kit.  $V_{CC} = +2.7V$  to  $+5.5V$ ,  $V_{TUNE} = +0.4V$  to  $+2.4V$ ,  $V_{SHDN} \geq +2.0V$ ,  $V_{MOD} = +1.4V$ , OUT is connected to a  $50\Omega$  load,  $T_A = +25^\circ C$ . Typical values are at  $V_{CC} = +3.0V$ ,  $T_A = +25^\circ C$ , unless otherwise noted.) (Note 1)

PARAMETER	SYMBOL	CONDITIONS	MIN	TYP	MAX	UNITS
Modulation Linearity		$V_{MOD} = +0.4$ to $+2.4V$ , $f_{MIN} < f < f_{MAX}$ (Note 4)		$\pm 4$		%
Modulation Full-Power Bandwidth (Note 5)				2.5		MHz
Return Loss (Note 6)		$f_{MIN} < f < f_{MAX}$		7.5		dB
Output Harmonics				-20		dBc
Load Pulling		VSWR = 2:1, all phases		1.5		MHz <sub>p-p</sub>
Supply Pushing		$V_{CC}$ stepped: $+3.3V$ to $+2.8V$		0.16		MHz/V
Oscillator Turn-On Time (Note 7)				10		$\mu s$
Oscillator Turn-Off Time (Note 8)				8		$\mu s$

**Note 1:** Specifications are production tested at  $T_A = +25^\circ C$ . Limits over temperature are guaranteed by design and characterization.

**Note 2:** Limits are guaranteed by production test at  $+25^\circ C$ .

**Note 3:** Center point is nominally  $+1.4V$ .

**Note 4:** Maximum variation in the modulation sensitivity from its average value over the guaranteed frequency limits.

**Note 5:** Bandwidth is defined as the point where the response to the modulation port is 0.707 times the low-frequency response.

Bandwidth limits on the modulation input for a 1Vp-p sine wave. Common-mode  $V_{MOD} = +1.4V$ .

**Note 6:** Refer to *Output Buffer* section for suggestions to improve the return loss to 12dB.

**Note 7:** Turn-on time to within 3dB of final output power.

**Note 8:** Turn-off time to output power of -10dBm.

# 1.2GHz VCO with Linear Modulation Input

## Typical Operating Characteristics

(MAX2754 EV kit,  $V_{CC} = +3.0V$ ,  $V_{SHDN} \geq +2.0V$ ,  $V_{TUNE} = V_{MOD} = +1.4V$ , and  $T_A = +25^\circ C$ , unless otherwise noted.)

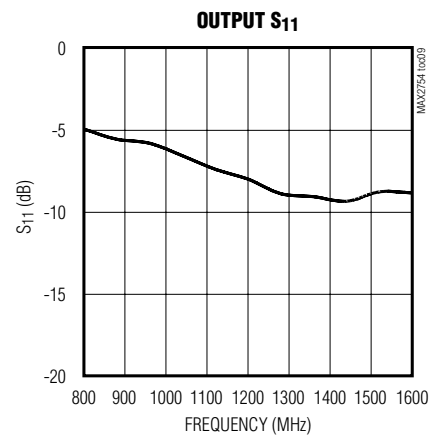
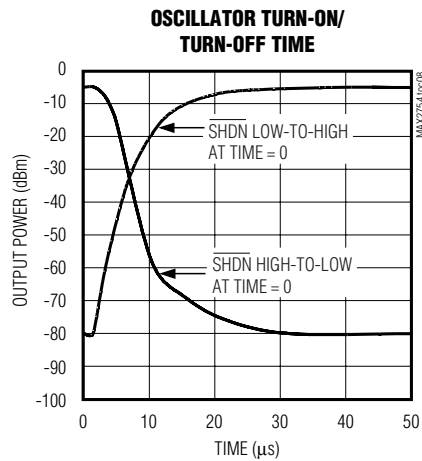
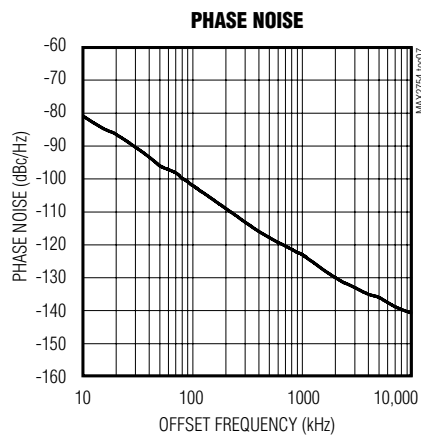
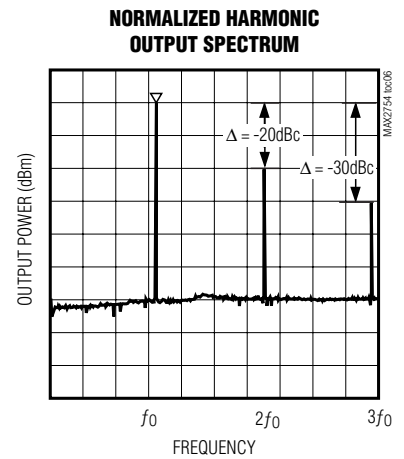
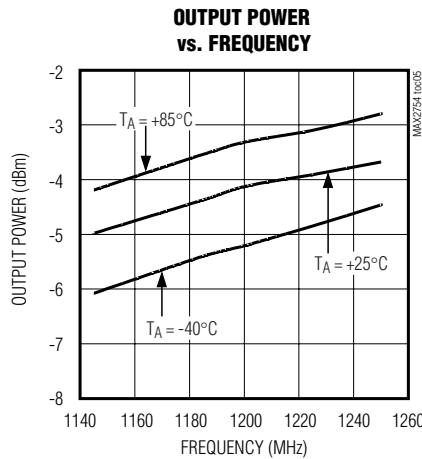
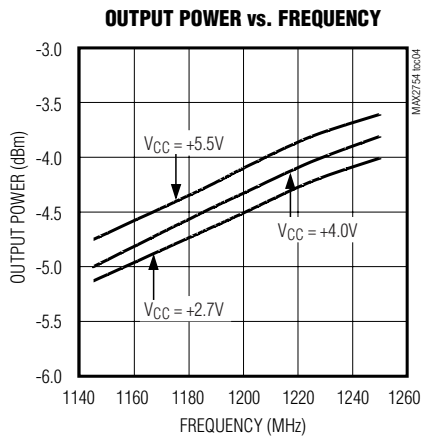
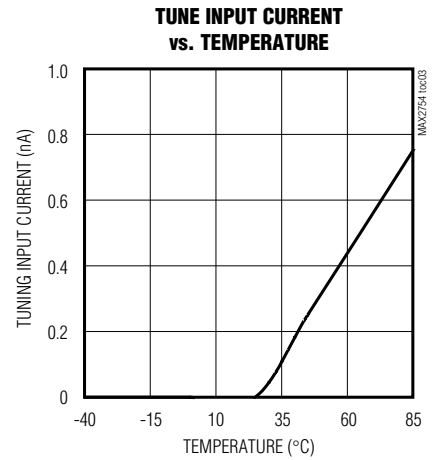
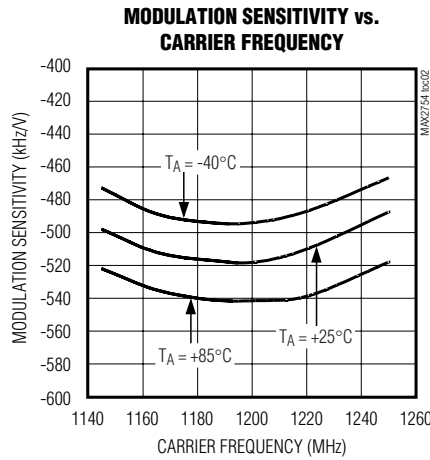
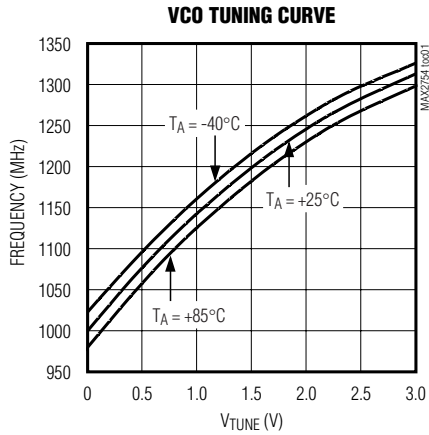

# 1.2GHz VCO with Linear Modulation Input

MAX2754

## Pin Description

PIN	NAME	FUNCTION
1	VREG	Capacitor Connection to the On-Chip Linear Regulator Output. Connect a 330nF capacitor to ground.
2	TUNE	Oscillator Frequency Tuning-Voltage Input. High-impedance input with a voltage range of +0.4V (low frequency) to +2.4V (high frequency).
3	GND1	Ground Connection for the Oscillator Core. Requires a low-inductance connection to the circuit-board ground plane.
4	MOD	Linear Modulation Input. High-impedance CMOS input with a voltage range of +0.4V to +2.4V.
5	$\overline{\text{SHDN}}$	Shutdown Input. Drive logic low to place the device in shutdown mode. Drive logic high for normal operation.
6	GND2	Ground Connection for Output-Buffered Amplifier, Linear Modulation Interface, and Biasing. Requires a low-inductance connection to the circuit-board ground plane.
7	OUT	Buffered Oscillator Output. Incorporates an internal DC-blocking capacitor. OUT is internally matched to 50 $\Omega$ .
8	V <sub>CC</sub>	Supply Voltage Connection. Requires external RF bypass capacitor to ground for low noise and low spurious content performance from the oscillator. Bypass with a 330pF capacitor to ground.

## Detailed Description

### Oscillator

The MAX2754 VCO is implemented as an LC oscillator topology, integrating all of the tank components on-chip. This fully monolithic approach provides an extremely easy-to-use VCO, equivalent to a VCO module. The frequency is controlled by a voltage applied to the TUNE pin. The VCO core uses a differential topology to provide a stable frequency versus supply voltage and improve the immunity to load variations. In addition, there is a buffer amplifier following the oscillator core to provide added isolation from load and supply variations and to boost the output power.

### Linear Modulation

The linear modulation input offers a means to directly FM modulate the VCO with a controlled amount of frequency deviation for a given input voltage deviation. The unique technique maintains a consistent modulation gain ( $df/dV_{MOD}$ ) across the entire frequency tuning range of the part, enabling accurate FM modulation derived solely from the filtered NRZ “data” stream (the modulation voltage input).

The modulation input is single-ended and centered about +1.4V. The linear modulation full-scale range is  $\pm 1V$  around this point, for a +0.4V to +2.4V input voltage range. A very important point to note is that the sign of the modulation gain is negative. A positive change in  $V_{MOD}$  results in a negative change in oscilla-

tion frequency. This convention for the modulation gain is due to the practical implementation of the internal linearizing circuitry. This gain inversion must be considered when designing the analog voltage interface that drives the linear modulation input. The easiest way to handle this is to invert the logic polarity of the modulation data three-state output buffer (TX data output). Where it is impossible to invert the data-stream logic polarity, an external inverter and three-state buffer would be required. These devices are offered in small single-logic gates in SC-79 style packages from various manufacturers (e.g., Fairchild—Tiny Logic, On Semiconductor, or Rohm).

Figure 1 illustrates the frequency versus  $V_{MOD}$  characteristic of the modulation input. Note the negative slope of the curve,  $df_{MOD}/dV_{MOD} < 0$ , where  $f_{MOD} = f_{OUT} - f_{NOM}$ .

### Output Buffer

The oscillator signal from the core drives an output buffer amplifier. The amplifier is internally matched to 50 $\Omega$  including an on-chip DC-blocking capacitor. The return loss can be improved to a minimum of 12dB over 1145MHz to 1250MHz by adding a 2.5nH series inductor and a 3.0pF shunt capacitor. The output buffer has a ground connection separate from the oscillator core to minimize load-pulling effects. The amplifier boosts the oscillator signal to a level suitable for driving most RF mixers.

# 1.2GHz VCO with Linear Modulation Input

## Applications Information

### Tune Input

The tuning input is typically connected to the output of the PLL loop filter. The loop filter provides an appropriately low-impedance source. Incorporate an extra RC filter stage to reduce high-frequency noise and spurious signals. Any excess noise on the tuning input is directly translated into FM noise, which can degrade the phase-noise performance of the oscillator. Therefore, it is important to minimize the noise introduced on the tuning input. A simple RC filter with low corner frequency is needed during testing to filter the noise present on the voltage source driving the tuning line.

### Two-Level FSK Applications

The MAX2754 is designed for use in FSK applications operating in the 2.4GHz to 2.5GHz ISM band. Specifically, it is targeted for those systems which utilize a direct TX modulation architecture in which the VCO is directly modulated with the data signal during the transmit (TX) mode. The VCO in these systems runs at half the RF output frequency and is used in conjunction with a frequency doubler to produce the final LO signal for both RX and TX modes of operation.

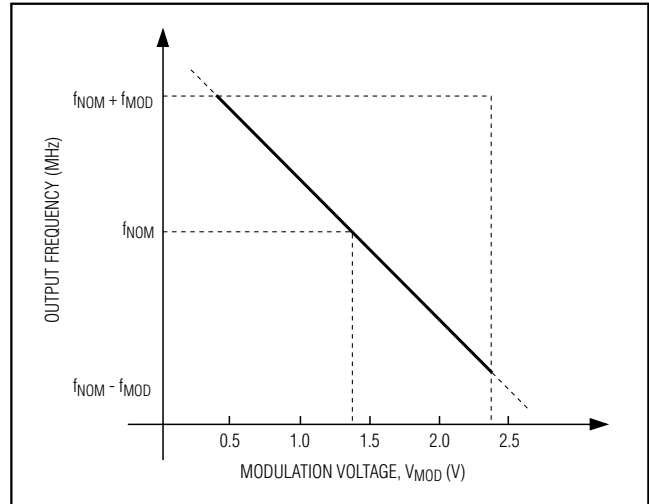

Figure 1. Modulation Frequency Deviations Characteristics

Figure 2 shows a typical applications circuit. To compute R1, R2, R3, and R4, determine the modulation voltage center point ( $V_{MODB} = +1.4V$ ). Compute the required modulation voltage deviation as follows:

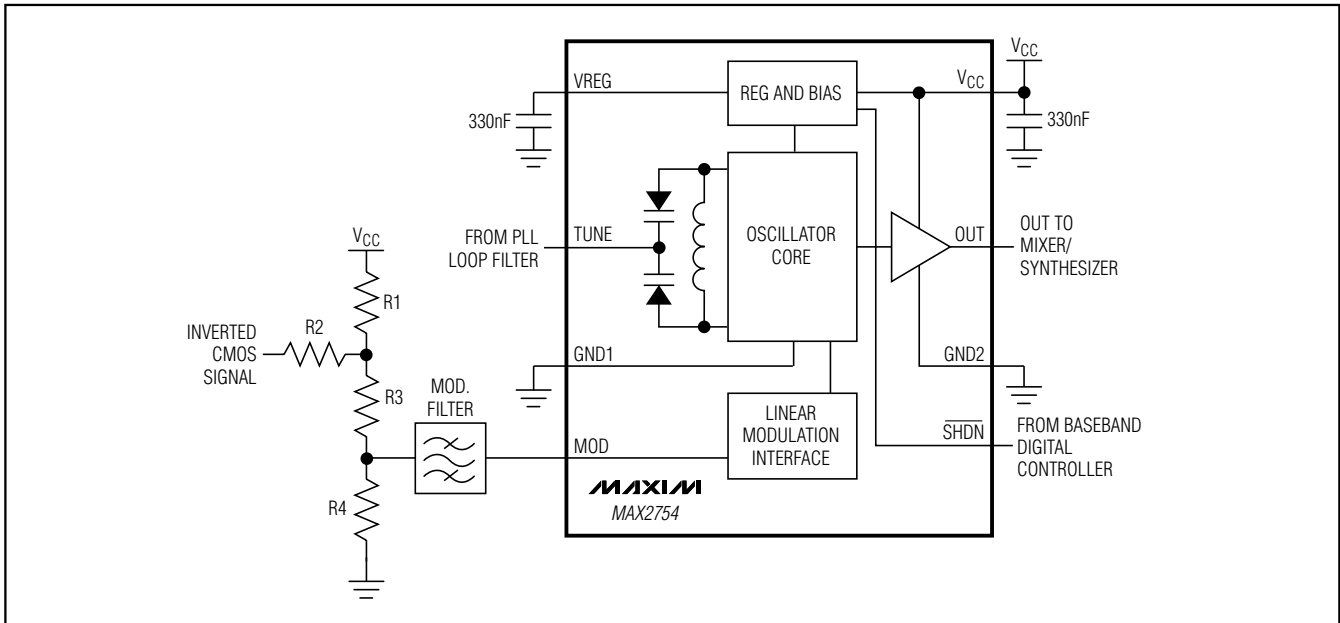

Figure 2. Typical Application Circuit for Two-Level FSK

# 1.2GHz VCO with Linear Modulation Input

$\Delta V = \Delta f / 500\text{kHz/V}$  (nominal modulation sensitivity)

Let  $R = R_1 + R_3 + R_4$ . Setting  $R$  based on the desired current from  $V_{CC}$  and filter impedance level:

$$R1 = \frac{R}{2},$$

$$R2 = \left( \frac{V_{MODB}}{\Delta V} - 1 \right) \times \frac{R}{4},$$

$$R3 = R \times \left( \frac{1}{2} - \frac{V_{MODB}}{V_{CC}} \right),$$

$$R4 = \frac{V_{MODB}}{V_{CC}} \times R$$

## Layout Issues

Use controlled impedance lines (microstrip, co-planar waveguide, etc.) each time for high-frequency signals. Always place decoupling capacitors as close to the  $V_{CC}$  pins as possible; for long  $V_{CC}$  lines, it may be necessary to add additional decoupling capacitors located further from the device. Always provide a low-inductance path to ground, and keep GND vias as close to the device as possible. Thermal reliefs on GND pads are not recommended.

## Chip Information

TRANSISTOR COUNT: 619

# 1.2GHz VCO with Linear Modulation Input

## Package Information

(The package drawing(s) in this data sheet may not reflect the most current specifications. For the latest package outline information go to [www.maxim-ic.com/packages](http://www.maxim-ic.com/packages).)

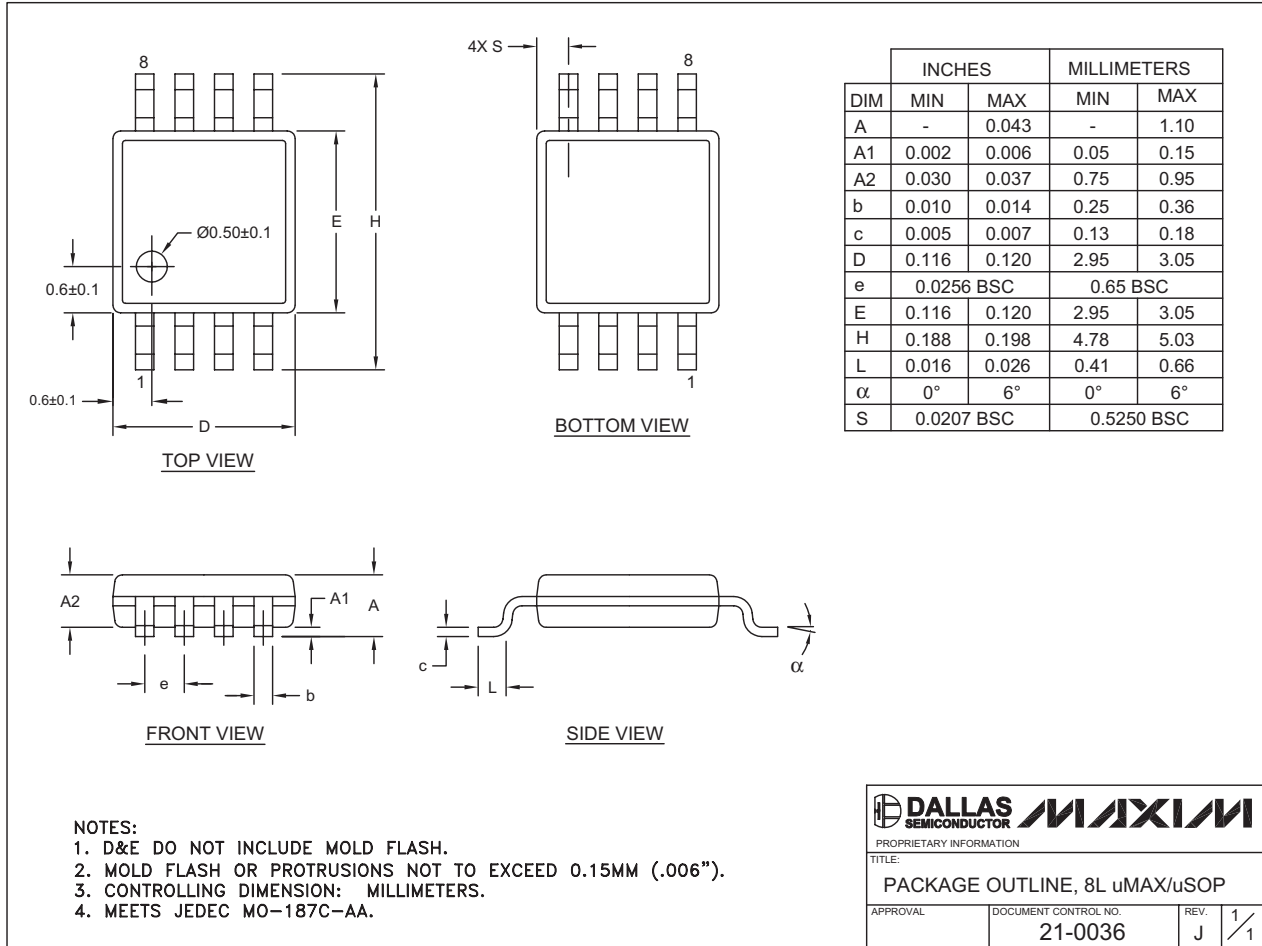

8LUMAXD.EPS

Maxim cannot assume responsibility for use of any circuitry other than circuitry entirely embodied in a Maxim product. No circuit patent licenses are implied. Maxim reserves the right to change the circuitry and specifications without notice at any time.

8 Maxim Integrated Products, 120 San Gabriel Drive, Sunnyvale, CA 94086 408-737-7600