



PIDG (Pre-Insulated Diamond Grip)

Product Facts

- Pre-insulated terminal designed for uniform reliability in most difficult circuit environments
- PIDG Terminals consist of tin plated copper or tin plated phosphor bronze body for spring spades with a copper sleeve and insulation sleeve fitted over terminal barrel
- Design of the tool dies and construction of the terminal allows for uniform insulation thickness under crimping pressure, transmitting this pressure evenly to the center of the crimp area

The AMP Mated Tool/Terminal Concept

- AMP compression crimping produces crimps for a given size wire and terminal that are alike in appearance and performance
- Terminal and crimping tool are designed as uniform matched devices
- Dies are precision-engineered from the finest hard-metal alloys
- Crimping pressure is controlled by a ratchet device on the hand tool or a corresponding pre-calibration in the crimping jaws of AMP automated crimping machines

The Crimp

- When done properly, crimping pressure can neither overstress nor under-stress the terminal barrel—machined dies fully bottom to the precise crimp height
- Resulting termination is free of contamination
- Resistant to shock and critical environments
- Tensile strength approaches that of the wire itself
- PIDG Terminals meet or exceed the requirements of MIL-T-7928, Type II, Class 1 and 2
- Refer to AMP Qualified Products for Military Application, Catalog 73-159 for Military Specification Number to AMP Part Number cross reference

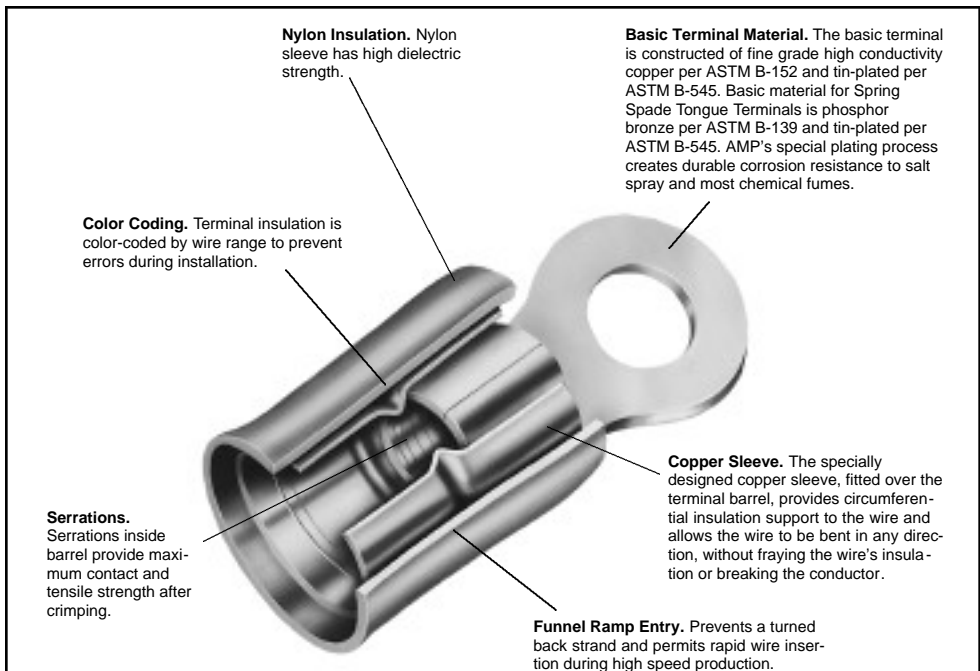

Temperature Rating: 105°C Max.

Note: Over size expansions are provided in vinyl insulation only.

AMP PIDG Terminals (Use PIDG Tooling)			AMP PIDG Nylon Butt Window Splice (Use PIDG Tooling)		
AMP Wire Range	UL Listed	LR7189 Certified	AMP Wire Range	UL Listed	LR7189 Certified
22-16	22-16 Solid or Stranded	300 V Max., 105°C. Max. ¹	22-16	22-16 Stranded or Solid	300 V Max., 105°C. Max.
16-14	16-14 Solid or Stranded		16-14	16-14 Stranded or Solid	
12-10	12-10 Solid or Stranded		12-10	12-10 Stranded or Solid	

Note: 22-16 terminals are stamped 22-18 in accordance with MIL-T-7928.
¹UL & CSA—Nylon

Note: 22-16 splices are stamped 22-18 in accordance with MIL-T-7928.

Table of Contents

Terminals

Ring Tongue 8-13

Ring Tongue (Vinyl) 14

Ring Tongue (Insulation Restricting) 15-17

Ring Tongue 90° Bend and Rectangular Tongue 90° Bend (Insulation Restricting) 18

Rectangular Tongue 19, 20

Rectangular Tongue (Insulation Restricting) and Spade Tongue 21, 22

Flanged Spade Tongue 23

Short Spring Spade Tongue 24

Long Spring Spade Tongue 25

Slotted Ring Tongue and Hook Tongue 26

Multiple Stud and Offset Ring Tongue 27

Offset Ring Tongue (Insulation Restricting) 28

Shur-Plug Terminal and 3-Way Connector Terminal 29

Tabs 30

Splices

Butt 31

Butt Step Down Adapter Inserts and Knife Disconnect 32

Dimensions are shown for reference purposes only.

Dimensions are in inches and millimeters unless otherwise specified. Values in brackets are metric equivalents.

Specifications subject to change.

Technical Support Center
1-800-522-6752
www.amp.com



PIDG (Pre-Insulated Diamond Grip) (Continued)

Ring Tongue Terminals

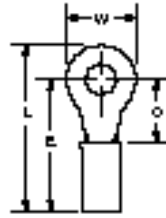

Material

Insulation — Nylon, UL 94V-2
Terminal Body and Metallic Sleeve — Copper per ASTM B-152
Plating — Tin per ASTM B-545

Related Product Data

Insulation Color Code — pg. 4
Packaging Quantities — pg. 4
Performance Specifications — pgs. 4 & 5
Application Tooling — pg. 72

Wire Size Circular Mills [mm ²]	Tongue Material Thickness Max.	Stud Size	Dimensions				Terminal Insulation Color	Wire Insulation Diameter Max.	Part Numbers	
			W	C Min.	E Max.	L Max.			Loose Piece	Tape Mounted
26-24 238-475 [0.12-0.24]	.029 0.74	2 M2	.203 5.16	.211 5.36	.632 16.05	.739 18.77	Yellow	.105 2.67	54310-1 [†]	—
		4	.203 5.16	.211 5.36	.632 16.05	.736 18.69	Yellow	.105 2.67	52189 [†]	—
		6 M3.5	.250 6.35	.243 6.17	.664 16.87	.792 20.12	Yellow	.105 2.67	53073 [†]	—
		8 M4	.281 7.14	.250 6.35	.671 17.04	.814 20.68	Yellow	.105 2.67	54311-1 [†]	—
		10	.312 7.92	.281 7.14	.702 17.83	.868 22.05	Yellow	.105 2.67	54312-1 [†]	54312-2 [†]
26-22 202-810 [0.10-0.41]	.020 0.51	0	.140 3.56	.121 3.07	.452 11.48	.525 13.34	Yellow	.082 2.08	321013	—
		2 M2	.140 3.56	.121 3.07	.452 11.48	.525 13.34	Yellow	.082 2.08	323912*	2-323912-1
			.140 3.56	.211 5.36	.542 13.77	.615 15.62	Yellow	.082 2.08	329951*	—
			.165 4.19	.211 5.36	.542 13.77	.617 15.67	Yellow/Br.	.082 2.08	321620*	1-321620-0
		4	.203 5.16	.211 5.36	.542 13.77	.646 16.41	Yellow	.082 2.08	323913	2-323913-1
			.203 5.16	.211 5.36	.542 13.77	.646 16.41	Yellow	.082 2.08	323914*	2-323914-1
			.198 5.03	.308 7.82	.643 16.33	.745 18.92	Yellow	.082 2.08	321617	—
		6 M3.5	.203 5.16	.211 5.36	.542 13.77	.646 16.41	Yellow	.082 2.08	323915*	2-323915-2
			.250 6.35	.281 7.14	.612 15.54	.740 18.80	Yellow	.082 2.08	326875*	2-326875-1
			.250 6.35	.281 7.14	.612 15.54	.740 18.80	Yellow	.082 2.08	323916*	2-323916-1
		8 M4	.300 7.62	.281 7.14	.612 15.54	.765 19.43	Yellow	.082 2.08	52124	52124-2
			.250 6.35	.281 7.14	.612 15.54	.740 18.80	Yellow	.082 2.08	324075*	2-324075-1
10	.300 7.62	.281 7.14	.612 15.54	.765 19.43	Yellow	.082 2.08	52124-1	—		
	0	.160 4.06	.125 3.18	.506 12.85	.589 14.96	Natural	.100 2.54	—	2-328489-1	
24-20 320-1,290 [0.16-0.65]	.025 0.64	2 M2	.160 4.06	.125 3.18	.506 12.85	.589 14.96	Natural	.100 2.54	329636	2-329636-1
		4	.203 5.16	.250 6.35	.631 16.03	.735 18.67	Natural	.100 2.54	50534	—
			.281 7.14	.250 6.35	.631 16.03	.774 19.66	Natural	.100 2.54	323985	—
		6 M3.5	.281 7.14	.250 6.35	.631 16.03	.774 19.66	Natural	.100 2.54	323986	2-323986-1
		8 M4	.312 7.92	.281 7.14	.662 16.81	.821 20.85	Natural	.100 2.54	323989	1-323989-0
		10	.312 7.92	.281 7.14	.662 16.81	.821 20.85	Natural	.100 2.54	323990	2-323990-1

*Available in small packaging quantities.

Note: "C" dimension applies from edge of metal wire barrel to center of stud hole.

[†]Must be crimped with 22-18 or 22-16 PIDG (red) Tooling.



PIDG (Pre-Insulated Diamond Grip) (Continued)

PIDG

Ring Tongue Terminals

(Continued)

Wire Size Circular Mils [mm ²]	Tongue Material Thickness Max.	Stud Size	Dimensions				Terminal Insulation Color	Wire Insulation Diameter Max.	Part Numbers		
			W	C Min.	E Max.	L Max.			Loose Piece	Tape Mounted	
22-16 509-3,260 [0.26-1.65]	.033 0.84	1	.160	.156	.560	.643	Red	.125	327174	2-327174-1	
			4.06	3.96	14.22	16.33		3.18			
		2	M2	.182	.172	.576	.669	Red	.125	324158	2-324158-1
				4.62	4.37	14.63	16.99		3.18		
		2	M2	.182	.172	.576	.669	Red	.140	320773	—
				4.62	4.37	14.63	16.99		3.56		
		2	M2	.218	.156	.560	.672	Red	.125	328657*	2-328657-1
				5.54	3.96	14.22	17.07		3.18		
		2	M2	.182	.172	.576	.669	Red/Green	.125	327654*	—
				4.62	4.37	14.63	16.99		3.18		
		2	M2	.182	.172	.576	.669	Red	.140	320882*	2-320882-1
				4.62	4.37	14.63	16.99		3.56		
		2	M2	.218	.156	.560	.672	Red	.125	320553*	2-320553-2
				5.54	3.96	14.22	17.07		3.18		
		4	M4	.218	.156	.560	.672	Red	.125	36254 ¹	—
				5.54	3.96	14.22	17.07		3.18		
		4	M4	.218	.156	.560	.672	Red	.140	31880*	2-31880-1
				5.54	3.96	14.22	17.07		3.56		
		4	M4	.218	.156	.560	.672	Black	.140	35229	—
				5.54	3.96	14.22	17.07		3.56		
		4	M4	.250	.312	.716	.844	Red	.125	323758	2-323758-1
				6.35	7.92	18.19	21.44		3.18		
		4	M4	.250	.312	.716	.844	Red	.140	330648	2-330648-1
				6.35	7.92	18.19	21.44		3.56		
		4	M4	.218	.156	.560	.672	Red	.125	36149*	2-36149-2
				5.54	3.96	14.22	17.07		3.18		
		4	M4	.218	.156	.560	.672	Red	.140	36150*	2-36150-1
				5.54	3.96	14.22	17.07		3.56		
6	M3.5	.250	.250	.654	.782	Red	.125	51863*	51863-1		
		6.35	6.35	16.61	19.86		3.18				
6	M3.5	.281	.250	.654	.797	Red	.125	36151*	2-36151-2		
		7.14	6.35	16.61	20.24		3.18				
6	M3.5	.281	.250	.654	.797	Red	.140	36152*	2-36152-1		
		7.14	6.35	16.61	20.24		3.56				
6	M3.5	.312	.281	.685	.844	Red	.125	323008	2-323008-1		
		7.92	7.14	17.40	21.44		3.18				
6	M3.5	.312	.281	.685	.844	Red	.140	326878	2-326878-1		
		7.92	7.14	17.40	21.44		3.56				
8	M4	.281	.250	.654	.797	Red	.125	320554*	2-320554-1		
		7.14	6.35	16.61	20.24		3.18				
8	M4	.281	.250	.654	.797	Red	.140	31886*	2-31886-2		
		7.14	6.35	16.61	20.24		3.56				
8	M4	.312	.281	.685	.844	Red	.125	320551*	1-320551-1		
		7.92	7.14	17.40	21.44		3.18				
8	M4	.312	.281	.685	.844	Red	.140	31890*	2-31890-1		
		7.92	7.14	17.40	21.44		3.56				
8	M4	.344	.297	.701	.876	Red	.140	32835	2-32835-2		
		8.74	7.54	17.81	22.25		3.56				
10	M4	.281	.250	.654	.797	Red	.125	320552*	2-320552-1		
		7.14	6.35	16.61	20.24		3.18				
10	M4	.281	.250	.654	.797	Red	.140	31887*	2-31887-1		
		7.14	6.35	16.61	20.24		3.56				
10	M4	.312	.281	.685	.844	Red	.125	36153*	2-36153-2		
		7.92	7.14	17.40	21.44		3.18				
10	M4	.312	.281	.685	.844	Red	.140	36154*	2-36154-2		
		7.92	7.14	17.40	21.44		3.56				
10	M4	.344	.297	.701	.876	Red	.125	32836*	—		
		8.74	7.54	17.81	22.25		3.18				
10	M4	.344	.297	.701	.876	Red	.140	32837*	32837-1		
		8.74	7.54	17.81	22.25		3.56				

*Available in small packaging quantities.

¹Slightly larger than standard #4 stud hole. (.128 in./3.25 mm.)

Note: "C" dimension applies from edge of metal wire barrel to center of stud hole.



PIDG (Pre-Insulated Diamond Grip) (Continued)

PIDG

Ring Tongue Terminals

(Continued)

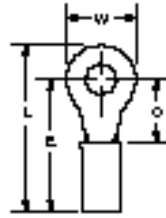

Material

Insulation — Nylon, UL 94V-2
Terminal Body and Metallic Sleeve — Copper per ASTM B-152
Plating — Tin per ASTM B-545

Related Product Data

Insulation Color Code — pg. 4
Packaging Quantities — pg. 4
Performance Specifications — pgs. 4 & 5
Application Tooling — pg. 72

Wire Size Circular Mills [mm ²]	Tongue Material Thickness Max.	Stud Size	Dimensions				Terminal Insulation Color	Wire Insulation Diameter Max.	Part Numbers			
			W	C Min.	E Max.	L Max.			Loose Piece	Tape Mounted		
22-16 509-3,260 [0.26-1.65]	.033 0.84	1/4 M6	.469	.437	.841	1.078	Red	.125 3.18	320571*	2-320571-2		
			11.91	11.10	21.36	27.38	Black	.125 3.18	55936-1	55936-2		
		5/16 M8	.469	.437	.841	1.078	Red	.140 3.56	31894*	2-31894-2		
			11.91	11.10	21.36	27.38	Red	.125 3.18	320572*	2-320572-1		
		3/8	.469	.437	.841	1.078	Red	.140 3.56	31895*	2-31895-1		
			11.91	11.10	21.36	27.38	Red	.125 3.18	324123	—		
		1/2 M12	.531	.546	.950	1.218	Red	.125 3.18	320573*	2-320573-4		
			13.49	13.87	24.13	30.94	Red	.140 3.56	31897*	2-31897-2		
		20-16HD ¹ 992-2,800 [0.50-1.42]	.042 1.07	10	.656	.437	.841	1.171	Red	.125 3.18	321522	—
					16.66	11.10	21.36	29.74	Red	.125 3.18	328975*	—
		16-14 2,050-5,180 [1.04-2.62]	.033 0.84	2 M2	.180	.171	.575	.668	Blue	.170 4.32	324993	—
					4.57	4.34	14.61	16.97	Blue	.150 3.81	324159*	2-324159-2
4	.250			.171	.575	.703	Blue	.170 4.32	328996*	2-328996-1		
	6.35			4.34	14.61	17.86	Blue	.150 3.81	323676	—		
6 M3.5	.250			.171	.575	.703	Blue	.150 3.81	320561*	2-320561-2		
	6.35			4.34	14.61	17.86	Blue	.170 4.32	320619*	2-320619-1		
8 M4	.250			.281	.685	.813	Blue	.170 4.32	50881	50881-2		
	6.35			7.14	17.40	20.65	Blue	.170 4.32	326882*	2-326882-1		
8 M4	.312			.250	.654	.813	Blue	.150 3.81	51864*	51864-3		
	7.92			6.35	16.61	20.65	Blue	.150 3.81	36157*	2-36157-2		
8 M4	.343			.281	.685	.859	Blue	.150 3.81	36158*	2-36158-1		
	8.71			7.14	17.40	21.82	Blue	.170 4.32	53941-1*	53941-2		
8 M4	.312			.250	.654	.813	Blue	.150 3.81	51864-1*	51864-5		
	7.92			6.35	16.61	20.65	Blue	.150 3.81	320560*	2-320560-1		
8 M4	.343			.281	.685	.859	Blue	.170 4.32	320565*	2-320565-1		
	8.71			7.14	17.40	21.82	Blue	.170 4.32				

*Available in small packaging quantities.

¹Heavy duty for extra mechanical strength.

Note: "C" dimension applies from edge of metal wire barrel to center of stud hole.



PIDG (Pre-Insulated Diamond Grip) (Continued)

PIDG

Ring Tongue Terminals (Continued)

Wire Size Circular Mills [mm ²]	Tongue Material Thickness Max.	Stud Size	Dimensions				Terminal Insulation Color	Wire Insulation Diameter Max.	Part Numbers			
			W	C Min.	E Max.	L Max.			Loose Piece	Tape Mounted		
16-14 2,050-5,180 [1.04-2.62]	.033 0.84	10	.312	.250	.654	.813	Blue	.170	53942-1	53942-2		
			7.92	6.35	16.61	20.65	Blue	4.32	51864-2*	51864-4		
			.312	.281	.685	.844	Blue	.150	320574*	2-320574-2		
			7.92	7.14	17.40	21.44	Blue	3.81	36160*	2-36160-1		
			.343	.281	.685	.859	Blue	.170	324533	2-324533-2		
		8.71	7.14	17.40	21.82	Blue	4.32	324086	2-324086-1			
		.469	.437	.841	1.078	Blue	.170	35274	—			
		11.91	11.10	21.36	27.38	Blue	4.32	320563*	2-320563-2			
		.469	.437	.841	1.078	Blue	.170	321045*	2-321045-1			
		11.91	11.10	21.36	27.38	Blue	4.32	325034	2-325034-1			
		.469	.437	.841	1.078	Black	.170	320575*	2-320575-1			
		11.91	11.10	21.36	27.38	Blue	3.81	328998*	2-328998-1			
		.469	.437	.841	1.078	Blue	.170	320564*	2-320564-3			
		11.91	11.10	21.36	27.38	Blue	4.32	328999*	2-328999-1			
		.531	.546	.950	1.218	Blue	.150	328976	—			
		13.49	13.87	24.13	30.94	Blue	3.81	328849*	—			
		.531	.546	.950	1.218	Blue	.170	—	—			
		13.49	13.87	24.13	30.94	Blue	4.32	—	—			
		16-14HD ¹ 2,050-5,180 [1.04-2.62]	.050 1.27	1/2 M12	.713	.530	.934	1.293	Blue	.150	328976	—
					18.11	13.46	23.72	32.84	Blue	3.81	328849*	—
.713	.530			.934	1.293	Blue	.170	—	—			
18.11	13.46			23.72	32.84	Blue	4.32	—	—			
4	.281			.219	.810	.953	Yellow/Blk.	.230	33734	—		
	7.14			5.56	20.57	24.21	Yellow/Blk.	5.84	320631*	2-320631-1		
6 M3.5	.281			.219	.810	.953	Yellow/Blk.	.230	35634*	—		
	7.14			5.56	20.57	24.21	Yellow/Blk.	6.35	33724	—		
8 M4	.343			.281	.872	1.046	Yellow/Blk.	.230	320627*	1-320627-0		
	8.71			7.14	22.15	26.57	Yellow/Blk.	5.84	35106*	2-35106-1		
10	.343			.281	.872	1.046	Yellow/Blk.	.250	320630*	2-320630-2		
	8.71			7.14	22.15	26.57	Yellow/Blk.	6.35	34805*	2-34805-1		
5/16 M8	.500			.344	1.179	1.432	Yellow/Blk.	.220	329391	—		
	12.70			8.74	29.95	36.37	Yellow/Blk.	5.59	34974*	2-34974-1		
1/4 M6	.500			.344	.935	1.188	Yellow/Blk.	.230	323682	2-323682-1		
	12.70			8.74	23.75	30.18	Yellow/Blk.	6.35	327743	1-327743-1		
5/16 M8	.531			.437	1.028	1.296	Yellow/Blk.	.230	34806*	2-34806-3		
	13.49			11.10	26.11	32.92	Yellow/Blk.	6.35	—	2-34806-2		
5/16 M8	.531			.437	1.028	1.296	Blue	.250	—	2-34806-2		
	13.49			11.10	26.11	32.92	Yellow/Blk.	6.35	34810	1-34810-1		

¹Available in small packaging quantities.
²Heavy duty for extra mechanical strength.
Note: "C" dimension applies from edge of metal wire barrel to center of stud hole.



PIDG (Pre-Insulated Diamond Grip) (Continued)

Ring Tongue Terminals
(Continued)

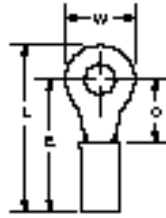

Material

Insulation — Nylon, UL 94V-2
Terminal Body and Metallic Sleeve — Copper per ASTM B-152
Plating — Tin per ASTM B-545 except where noted.

Related Product Data

Insulation Color Code — pg. 4
Packaging Quantities — pg. 4
Performance Specifications — pgs. 4 & 5
Application Tooling — pg. 72

Wire Size Circular Mills [mm ²]	Tongue Material Thickness Max.	Stud Size	Dimensions				Terminal Insulation Color	Wire Insulation Diameter Max.	Part Numbers			
			W	C Min.	E Max.	L Max.			Loose Piece	Tape Mounted		
16-14HD ¹ 2,050-5,180 [1.04-2.62]	.050 1.27	3/8	.531	.437	1.028	1.296	Yellow/Blk.	.230	330896	—		
			13.49	11.10	26.11	32.92		5.84				
		1/2	.750	.625	1.216	1.594	Yellow/Blk.	.250	35316*	—		
			19.05	15.88	30.89	40.49		6.35				
		M12	1.250	1.000	1.591	2.219	Yellow/Blk.	.250	36203	—		
			31.75	25.40	40.41	56.36		6.35				
		3/4	1.250	1.000	1.591	2.219	Yellow/Blk.	.250	322724	—		
			31.75	25.40	40.41	56.36		6.35				
		12-10 5,180-13,100 [2.62-6.64]	.042 1.07	4	.281	.219	.810	.953	Yellow	.250	35148*	1-35148-1
					7.14	5.56	20.57	24.21		6.35		
				6 M3.5	.281	.219	.810	.953	Yellow	.230	320634*	2-320634-1
					7.14	5.56	20.57	24.21		5.84		
.281	.219				.810	.953	Yellow	.250	35149*	2-35149-1		
7.14	5.56				20.57	24.21		6.35				
.312	.302				.893	1.052	Yellow	.230	326886	326886-1		
7.92	7.67				22.68	26.72		5.84				
.375	.302			.893	1.083	Yellow	.230	320567*	2-320567-2			
9.53	7.67			22.68	27.51		5.84					
.375	.302			.893	1.083	Yellow	.250	35107*	2-35107-1			
9.53	7.67			22.68	27.51		6.35					
8 M4	.312			.281	.872	1.031	Yellow	.230	35787*	1-35787-0		
	7.92			7.14	22.15	26.19		5.84				
	.312			.302	.893	1.052	Yellow	.230	324915*	—		
	7.92			7.67	22.68	26.72		5.84				
	.375			.302	.893	1.083	Yellow	.230	320568*	2-320568-1		
	9.53			7.67	22.68	27.51		5.84				
.375	.302			.893	1.083	Yellow	.250	35108*	2-35108-1			
9.53	7.67			22.68	27.51		6.35					
10	.312			.302	.893	1.052	Yellow	.230	324918*	1-324918-0		
	7.92			7.67	22.68	26.72		5.84				
	.343			.281	.872	1.046	Yellow	.230	32883*	1-32883-0		
	8.71			7.14	22.15	26.57		5.84				
	.375	.302	.893	1.083	Yellow	.230	36161*	2-36161-2				
	9.53	7.67	22.68	27.51		5.84						
.375	.302	.893	1.083	Yellow	.250	35109*	2-35109-1					
9.53	7.67	22.68	27.51		6.35							
1/4 M6	.500	.344	.935	1.188	Yellow	.230	2-323762-1	2-323762-3				
	12.70	8.74	23.75	30.18		5.84						
	.500	.344	1.179	1.432	Yellow	.220	329389	—				
	12.70	8.74	29.95	36.37		5.59						
	.500	.344	.935	1.188	Yellow	.230	35273*	2-35273-2				
	12.70	8.74	23.75	30.18		5.84						
.531	.468	1.054	1.322	Yellow	.230	320569*	2-320569-3					
13.49	11.89	26.77	33.58		5.84							
.531	.468	1.054	1.322	Yellow	.230	—	2-32545-4 ²					
13.49	11.89	26.77	33.58		5.84							
.531	.468	1.054	1.322	Yellow	.250	35110*	2-35110-1					
13.49	11.89	26.77	33.58		6.35							

*Available in small packaging quantities.
¹Heavy duty for extra mechanical strength.
²Terminal body plating— Gold per MIL-G-45204 Type II over Nickel per QQ-N-290.
³Terminal body plating— Nickel per QQ-N-290.
Note: "C" dimension applies from edge of metal wire barrel to center of stud hole.



PIDG (Pre-Insulated Diamond Grip) (Continued)

PIDG

Ring Tongue Terminals (Continued)

Wire Size Circular Mills [mm ²]	Tongue Material Thickness Max.	Stud Size	Dimensions				Terminal Insulation Color	Wire Insulation Diameter Max.	Part Numbers	
			W	C Min.	E Max.	L Max.			Loose Piece	Tape Mounted
12-10 5,180-13,100 [2.62-6.64]	.042 1.07	M5	.375 9.53	.302 7.67	.967 24.56	1.160 29.46	Yellow	.300 7.62	—	55157-2 ¹
		5/16 M8	.531 13.49	.468 11.89	1.054 26.77	1.322 33.58	Yellow	.230 5.84	320576*	2-320576-1
			.531 13.49	.468 11.89	1.054 26.77	1.322 33.58	Yellow	.250 6.35	35111*	2-35111-1
		3/8	.593 15.06	.531 13.49	1.115 28.32	1.414 35.92	Yellow	.230 5.84	320577*	2-320577-3
			.593 15.06	.531 13.49	1.115 28.32	1.414 35.92	Yellow	.250 6.35	35112*	—
		1/2 M12	.750 19.05	.625 15.88	1.216 30.89	1.594 40.49	Yellow	.250 6.35	35150	—
			.715 18.16	.474 12.04	1.065 27.05	1.414 35.92	Yellow	.230 5.84	52077	—
		5/8 M16	.715 18.16	.560 14.22	1.151 29.24	1.511 38.38	Yellow	.230 5.84	331467	—
			.750 19.05	.625 15.88	1.216 30.89	1.594 40.49	Yellow	.230 5.84	323784	—
		5/8 M16	.750 19.05	.625 15.88	1.216 30.89	1.594 40.49	Yellow	.250 6.35	35151*	—
			1.250 31.75	1.000 25.40	1.591 40.41	2.219 56.36	Yellow	.230 5.84	324615	—

*Available in small packaging quantities.

Note: "C" dimension applies from edge of metal wire barrel to center of stud hole.

¹Vinyl insulation material



PIDG (Pre-Insulated Diamond Grip) (Continued)

Ring Tongue Terminals (Vinyl)

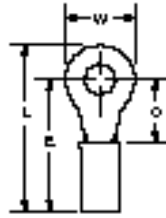

Material

Insulation — Vinyl, UL 94V-0
Terminal Body and Metallic Sleeve — Copper per ASTM B-152
Plating — Tin per ASTM B-545 except where noted.

Related Product Data

Insulation Color Code — pg. 4
Packaging Quantities — pg. 4
Performance Specifications — pgs. 4 & 5
Application Tooling — pg. 72

Wire Size Circular Mills [mm ²]	Tongue Material Thickness Max.	Stud Size	Dimensions				Terminal Insulation Color	Wire Insulation Diameter Max.	Part Numbers	
			W	C Min.	E Max.	L Max.			Loose Piece	Tape Mounted
22-16 509-3,260 [0.26-1.65]	.033 0.84	6 M3.5	.281	.250	.654	.797	Red	.140	31885	—
			7.14	6.35	16.61	20.24		.356		
		8 M4	.312	.281	.685	.844	Red	.125	31888	—
			7.92	7.14	17.40	21.44		3.18		
			.312	.281	.685	.844	Red	.125	2-31888-1 ²	—
			7.92	7.14	17.40	21.44		3.18		
16-14 2,050-5,180 [1.04-2.62]	.033 0.84	10	.281	.250	.654	.797	Red	.125	31884	—
			7.14	6.35	16.61	20.24		3.18		
		10	.312	.281	.685	.844	Red	.140	31891	—
			7.92	7.14	17.40	21.44		3.56		
			.312	.250	.654	.813	Blue	.170	—	2-322238-1
			7.92	6.35	16.61	20.65		4.32		
16-14HD ¹ 2,050-5,180 [1.04-2.62]	.050 1.27	10	.312	.281	.685	.844	Blue	.150	—	51861-4
			7.92	7.14	17.40	21.44		3.81		
		1/4 M6	.343	.281	.685	.859	Blue	.170	31903	—
			8.71	7.14	17.40	21.82		4.32		
			.343	.281	.961	1.135	Yellow/Blk.	.300	35363*	—
			8.71	7.14	24.41	28.83		7.62		
12-10 5,180-13,100 [2.62-6.64]	.042 1.07	5/16 M8	.531	.437	1.117	1.385	Yellow/Blk.	.300	35538	—
			13.49	11.10	28.37	35.18		7.62		
		1/2 M12	.531	.437	1.117	1.385	Yellow/Blk.	.300	36485	—
			13.49	11.10	28.37	35.18		7.62		
			1.250	1.000	1.680	2.308	Yellow/Blk.	.300	35604	—
			31.75	25.40	42.67	58.62		7.62		
12-10 5,180-13,100 [2.62-6.64]	.042 1.07	6 M3.5	.375	.302	.982	1.172	Yellow	.300	35605*	2-35605-2
			9.53	7.67	24.94	29.77		7.62		
		8 M4	.375	.302	.982	1.172	Yellow	.300	35364*	2-35364-1
			9.53	7.67	24.94	29.77		7.62		
		10	.375	.302	.982	1.172	Yellow	.300	—	55157-2
			9.53	7.67	24.94	29.77		7.62		
		5mm ³	.375	.302	.967	1.160	Yellow	.300	323763	2-323763-2
			9.53	7.67	24.56	29.46		7.62		
		1/4 M6	.500	.344	1.024	1.277	Yellow	.300	35345*	2-35345-1
			12.70	8.74	26.01	32.44		7.62		
		5/16 M8	.531	.468	1.148	1.416	Yellow	.300	35346*	2-35346-1
			13.49	11.89	29.16	35.97		7.62		
3/8	.531	.468	1.148	1.416	Yellow	.300	35478	1-35478-0		
	13.49	11.89	29.16	35.97		7.62				
3/8	.593	.531	1.211	1.510	Yellow	.300	—	—		
	15.06	13.49	30.76	38.35		7.62				

*Available in small packaging quantities.
¹Heavy duty for extra mechanical strength.
²Terminal body plating— Gold per MIL-G-45204 Type II over Nickel per QQ-N-290.
³#10 stud may be substituted.
Note: "C" dimension applies from edge of metal wire barrel to center of stud hole.



PIDG (Pre-Insulated Diamond Grip) (Continued)

Ring Tongue Terminals
(Insulation Restricting)

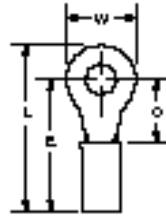

Material

Insulation — Nylon, UL 94V-2
Terminal Body — Copper per ASTM B-152
Plating — Tin per ASTM B-545
Metallic Sleeve — Copper per ASTM B-152
Plating — Nickel per QQ-N-290 or Tin per ASTM B-545

Related Product Data

Insulation Color Code — pg. 4
Packaging Quantities — pg. 4
Performance Specifications — pgs. 4 & 5
Application Tooling — pg. 72

Wire Size Circular Mils [mm ²]	Tongue Material Thickness Max.	Stud Size	Dimensions				Terminal Insulation Color Solid/Stripe	Wire Insulation Diameter Range	Part Numbers	
			W	C Min.	E Max.	L Max.			Loose Piece	Tape Mounted
26 304 [0.15]	.029 0.74	2 M2	.203 5.16	.211 5.36	.632 16.05	.739 18.77	Yellow/Black	.026-.055 0.66-1.40	53078 [†]	—
		4	.203 5.16	.211 5.36	.632 16.05	.736 18.69	Yellow/Black	.026-.055 0.66-1.40	53049 [†]	—
		6 M3.5	.250 6.35	.243 6.17	.664 16.87	.792 20.12	Yellow/Black	.026-.055 0.66-1.40	53050 [†]	—
		8 M4	.281 7.14	.250 6.35	.671 17.04	.814 20.68	Yellow/Black	.026-.055 0.66-1.40	53051 [†]	—
		10	.312 7.92	.281 7.14	.702 17.83	.863 21.92	Yellow/Black	.026-.055 0.66-1.40	53052 [†]	—
24 475 [0.24]	.020 0.51	4	.203 5.16	.211 5.36	.587 14.91	.691 17.55	Yellow/Blue	.031-.055 0.79-1.40	2-323914-2	—
		6 M3.5	.250 6.35	.281 7.14	.657 16.69	.785 19.94	Yellow/Blue	.031-.055 0.79-1.40	2-326875-4	—
		8 M4	.250 6.35	.281 7.14	.657 16.69	.785 19.94	Yellow/Blue	.031-.055 0.79-1.40	2-323916-3	—
		10	.250 6.35	.281 7.14	.657 16.69	.785 19.94	Yellow/Blue	.031-.055 0.79-1.40	2-326875-5	—
		2 M2	.203 5.16	.211 5.36	.632 16.05	.739 18.77	Yellow/Blue	.031-.055 0.79-1.40	53053 [†]	—
22 754 [0.38]	.029 0.74	4	.203 5.16	.211 5.36	.632 16.05	.736 18.69	Yellow/Blue	.031-.055 0.79-1.40	53054 [†]	—
		6 M3.5	.250 6.35	.243 6.17	.664 16.87	.792 20.12	Yellow/Blue	.031-.055 0.79-1.40	53055 [†]	53055-1 [†]
		8 M4	.281 7.14	.250 6.35	.671 17.04	.814 20.68	Yellow/Blue	.031-.055 0.79-1.40	53056 [†]	—
		10	.312 7.92	.281 7.14	.702 17.83	.860 21.84	Yellow/Blue	.031-.055 0.79-1.40	53057 [†]	53057-1 [†]
		2 M2	.182 4.62	.172 4.37	.638 16.21	.731 18.57	Red/Green	.038-.110 0.97-2.79	52307	—
22 754 [0.38]	.033 0.84	4	.218 5.54	.156 3.96	.622 15.80	.734 18.64	Red/Green	.038-.110 0.97-2.79	52273*	—
		6 M3.5	.218 5.54	.156 3.96	.622 15.80	.734 18.64	Red/Green	.038-.110 0.97-2.79	2-36149-3*	—
		6 M3.5	.250 6.35	.250 6.35	.716 18.19	.844 21.44	Red/Green	.038-.110 0.97-2.79	51863-2*	51863-5
		8 M4	.312 7.92	.281 7.14	.747 18.97	.906 23.01	Red/Green	.038-.110 0.97-2.79	1-320551-2*	1-320551-5
		10	.312 7.92	.281 7.14	.747 18.97	.906 23.01	Red/Green	.038-.110 0.97-2.79	2-36153-3*	2-36153-6
		1/4 M6	.469 11.91	.437 11.10	.903 22.94	1.140 28.96	Red/Green	.038-.110 0.97-2.79	2-320571-3	—
		5/16 M8	.469 11.91	.437 11.10	.903 22.94	1.140 28.96	Red/Green	.038-.110 0.97-2.79	2-320572-2	—
		3/8	.531 13.49	.546 13.87	1.012 25.70	1.280 32.51	Red/Green	.038-.110 0.97-2.79	2-320573-1	—
1/2 M12	.713 18.11	.530 13.46	.996 25.30	1.355 34.42	Red/Green	.038-.110 0.97-2.79	2-328975-1	—		

*Available in small packaging quantities.

Note: "C" dimension applies from edge of metal wire barrel to center of stud hole.

[†]Must be crimped with 22-18 or 22-16 PIDG (red) Tooling.



PIDG (Pre-Insulated Diamond Grip) (Continued)

Ring Tongue Terminals
(Insulation Restricting)

(Continued)

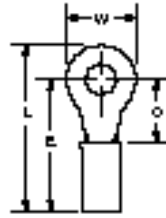

Material

Insulation — Nylon, UL 94V-2
Terminal Body — Copper per ASTM B-152
Plating — Tin per ASTM B-545
Metallic Sleeve — Copper per ASTM B-152
Plating — Nickel per QQ-N-290 or Tin per ASTM B-545

Related Product Data

Insulation Color Code — pg. 4
Packaging Quantities — pg. 4
Performance Specifications — pgs. 4 & 5
Application Tooling — pg. 72

Wire Size Circular Mils [mm ²]	Tongue Material Thickness Max.	Stud Size	Dimensions				Terminal Insulation Color Solid/Stripe	Wire Insulation Diameter Range	Part Numbers			
			W	C Min.	E Max.	L Max.			Loose Piece	Tape Mounted		
20 1,186 [0.60]	.033 0.84	2 M2	.182 4.62	.172 4.37	.638 16.21	.731 18.57	Red/Red	.046-.110 1.17-2.79	52307-1	—		
		4	.218 5.54	.156 3.96	.622 15.80	.734 18.64	Red/Red	.046-.110 1.17-2.79	52273-1*	—		
		6 M3.5	.218 5.54	.156 3.96	.622 15.80	.734 18.64	Red/Red	.046-.110 1.17-2.79	2-36149-4*	—		
			.250 6.35	.250 6.35	.716 18.19	.844 21.44	Red/Red	.046-.110 1.17-2.79	51863-3	51863-6		
		8 M4	.312 7.92	.281 7.14	.747 18.97	.906 23.01	Red/Red	.046-.110 1.17-2.79	1-320551-3*	1-320551-7		
		10	.312 7.92	.281 7.14	.747 18.97	.906 23.01	Red/Red	.046-.110 1.17-2.79	2-36153-4*	—		
		1/4 M6	.469 11.91	.437 11.10	.903 22.94	1.140 28.96	Red/Red	.046-.110 1.17-2.79	2-320571-4	—		
		5/16 M8	.469 11.91	.437 11.10	.903 22.94	1.140 28.96	Red/Red	.046-.110 1.17-2.79	2-320572-3	—		
		3/8	.531 13.49	.546 13.87	1.012 25.70	1.280 32.51	Red/Red	.046-.110 1.17-2.79	2-320573-2	—		
		1/2 M12	.713 18.11	.530 13.46	.996 25.30	1.355 34.42	Red/Red	.046-.110 1.17-2.79	2-328975-2	—		
		18 1,900 [0.96]	.033 0.84	4	.218 5.54	.156 3.96	.622 15.80	.734 18.64	Red/White	.056-.110 1.42-2.79	52273-2*	—
				6 M3.5	.218 5.54	.156 3.96	.622 15.80	.734 18.64	Red/White	.056-.110 1.42-2.79	2-36149-5*	—
.250 6.35	.250 6.35				.716 18.19	.844 21.44	Red/White	.056-.110 1.42-2.79	51863-4*	51863-7		
8 M4	.312 7.92			.281 7.14	.747 18.97	.906 23.01	Red/White	.056-.110 1.42-2.79	1-320551-4*	1-320551-8		
10	.312 7.92			.281 7.14	.747 18.97	.906 23.01	Red/White	.056-.110 1.42-2.79	2-36153-5*	2-36153-9		
1/4 M6	.469 11.91			.437 11.10	.903 22.94	1.140 28.96	Red/White	.056-.110 1.42-2.79	2-320571-5	—		
5/16 M8	.469 11.91			.437 11.10	.903 22.94	1.140 28.96	Red/White	.056-.110 1.42-2.79	2-320572-4	2-320574-7		
3/8	.531 13.49			.546 13.87	1.012 25.70	1.280 32.51	Red/White	.056-.110 1.42-2.79	2-320573-3	—		
1/2 M12	.713 18.11			.530 13.46	.996 25.30	1.355 34.42	Red/White	.056-.110 1.42-2.79	2-328975-3	—		
16 2,800 [1.42]	.033 0.84			4	.250 6.35	.171 4.34	.637 16.18	.765 19.43	Blue/Blue	.063-.130 1.60-3.30	52274	—
				6 M3.5	.250 6.35	.171 4.34	.637 16.18	.765 19.43	Blue/Blue	.063-.130 1.60-3.30	2-320561-3*	2-320561-5
					.312 7.92	.281 7.14	.747 18.97	.906 23.01	Blue/Blue	.063-.130 1.60-3.30	51864-6*	1-51864-2
		8 M4	.312 7.92	.281 7.14	.747 18.97	.906 23.01	Blue/Blue	.063-.130 1.60-3.30	1-51864-0*	1-51864-6		
		10	.312 7.92	.281 7.14	.747 18.97	.906 23.01	Blue/Blue	.063-.130 1.60-3.30	51864-7*	—		
		1/4 M6	.469 11.91	.437 11.10	.903 22.94	1.140 28.96	Blue/Blue	.063-.130 1.60-3.30	2-320563-3	—		
		5/16 M8	.469 11.91	.437 11.10	.903 22.94	1.140 28.96	Blue/Blue	.063-.130 1.60-3.30	2-320575-2	—		
		3/8	.531 13.49	.546 13.87	1.012 25.70	1.280 32.51	Blue/Blue	.063-.130 1.60-3.30	2-320564-1	—		
		1/2 M12	.713 18.11	.530 13.46	.996 25.30	1.355 34.42	Blue/Blue	.063-.130 1.60-3.30	2-328976-1	—		

*Available in small packaging quantities.

Note: "C" dimension applies from edge of metal wire barrel to center of stud hole.



PIDG (Pre-Insulated Diamond Grip) (Continued)

PIDG

Ring Tongue Terminals
(Insulation Restricting)

(Continued)

Wire Size Circular Mils [mm ²]	Tongue Material Thickness Max.	Stud Size	Dimensions				Terminal Insulation Color Solid/Stripe	Wire Insulation Diameter Range	Part Numbers			
			W	C Min.	E Max.	L Max.			Loose Piece	Tape Mounted		
14 4,234 [2.15]	.033 0.84	4	.250 6.35	.171 4.34	.637 16.18	.765 19.43	Blue/Green	.078-.130 1.98-3.30	52274-1	—		
		6 M3.5	.250 6.35	.171 4.34	.637 16.18	.765 19.43	Blue/Green	.078-.130 1.98-3.30	2-320561-4	—		
			.312 7.92	.281 7.14	.747 18.97	.906 23.01	Blue/Green	.078-.130 1.98-3.30	51864-8*	1-51864-4		
		8 M4	.312 7.92	.281 7.14	.747 18.97	.906 23.01	Blue/Green	.078-.130 1.98-3.30	1-51864-1*	1-51864-7		
			.312 7.92	.281 7.14	.747 18.97	.906 23.01	Blue/Green	.078-.130 1.98-3.30	51864-9*	1-51864-5		
		1/4 M6	.469 11.91	.437 11.10	.903 22.94	1.140 28.96	Blue/Green	.078-.130 1.98-3.30	2-320563-4	—		
			5/16 M8	.469 11.91	.437 11.10	.903 22.94	1.140 28.96	Blue/Green	.078-.130 1.98-3.30	2-320575-3	—	
		3/8	.531 13.49	.546 13.87	1.012 25.70	1.280 32.51	Blue/Green	.078-.130 1.98-3.30	2-320564-2	—		
		1/2 M12	.713 18.11	.530 13.46	.996 25.30	1.355 34.42	Blue/Green	.078-.130 1.98-3.30	2-328976-2	—		
		12 6,654 [3.37]	.042 1.07	6 M3.5	.375 9.53	.302 7.67	.958 24.33	1.148 29.16	Yellow/Yellow	.095-.200 2.41-5.08	2-36161-5	—
8 M4	.375 9.53			.302 7.67	.958 24.33	1.148 29.16	Yellow/Yellow	.095-.200 2.41-5.08	2-320568-2*	—		
	.375 9.53			.302 7.67	.958 24.33	1.148 29.16	Yellow/Yellow	.095-.200 2.41-5.08	2-36161-3*	—		
1/4 M6	.531 13.49			.468 11.89	1.124 28.55	1.392 35.36	Yellow/Yellow	.095-.200 2.41-5.08	2-320569-5	—		
	5/16 M8			.531 13.49	.468 11.89	1.124 28.55	1.392 35.36	Yellow/Yellow	.095-.200 2.41-5.08	2-320576-2	—	
3/8	.593 15.06			.531 13.49	1.187 30.15	1.486 37.74	Yellow/Yellow	.095-.200 2.41-5.08	2-320577-1	—		
1/2 M12	.715 18.16			.474 12.04	1.130 28.70	1.490 37.85	Yellow/Yellow	.095-.200 2.41-5.08	52077-1	—		
10 12,066 [6.11]	.042 1.07			6 M3.5	.375 9.53	.302 7.67	.958 24.33	1.148 29.16	Yellow/Brown	.119-.200 3.02-5.08	2-36161-6	3-36161-0
				8 M4	.375 9.53	.302 7.67	.958 24.33	1.148 29.16	Yellow/Brown	.119-.200 3.02-5.08	2-320568-3*	—
					.375 9.53	.302 7.67	.958 24.33	1.148 29.16	Yellow/Brown	.119-.200 3.02-5.08	2-36161-4	2-36161-8
		1/4 M6	.531 13.49	.468 11.89	1.124 28.55	1.392 35.36	Yellow/Brown	.119-.200 3.02-5.08	2-320569-6	2-320569-8		
			5/16 M8	.531 13.49	.468 11.89	1.124 28.55	1.392 35.36	Yellow/Brown	.119-.200 3.02-5.08	2-320576-3	—	
		3/8	.593 15.06	.531 13.49	1.187 30.15	1.486 37.74	Yellow/Brown	.119-.200 3.02-5.08	2-320577-2	—		
		1/2 M12	.715 18.16	.474 12.04	1.130 28.70	1.490 37.85	Yellow/Brown	.119-.200 3.02-5.08	52077-2	—		

*Available in small packaging quantities.

Note: "C" dimension applies from edge of metal wire barrel to center of stud hole.

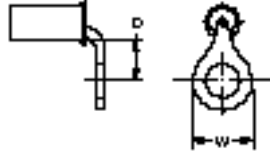
**PIDG (Pre-Insulated Diamond Grip)** (Continued)**Ring Tongue Terminal
90° Bend****Material**

Insulation—Vinyl, UL 94V-0
Terminal Body and Metallic Sleeve—Copper per ASTM B-152
Plating—Tin per ASTM B-545

Related Product Data

Insulation Color Code—pg. 4
Packaging Quantities—pg. 4
Performance Specifications—pgs. 4 & 5
Application Tooling—pg. 72

	Wire Size Cicular Mils [mm ²]	Tongue Material Thickness Max.	Stud Size	Dimensions		Terminal Insulation Color	Wire Insulation Diameter Max.	Part Number Loose Piece
				W	D Min.			
Vinyl	22-16 509-3,260 [0.26-1.65]	.033 0.84	10	.312 7.92	.157 3.99	Red	.140 3.56	55148-1
Nylon	12-10 5,180-13,100 [2.62-6.64]	.040 1.02	6	.375 9.53	.206 5.23	Yellow	.250 6.35	696020-1



PIDG (Pre-Insulated Diamond Grip) (Continued)

Rectangular Tongue Terminals

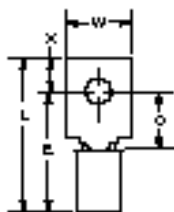

Material

Insulation — Nylon except where noted.

Terminal Body and Metallic Sleeve — Copper per ASTM B-152 except where noted.

Plating — Tin per ASTM B-545

Related Product Data

Insulation Color Code — pg. 4

Packaging Quantities — pg. 4

Performance Specifications — pgs. 4 & 5

Application Tooling — pg. 72

Wire Size Circular Mils [mm ²]	Tongue Material Thickness Max.	Stud Size	Dimensions					Terminal Insulation Color	Wire Insulation Diameter Max.	Part Numbers			
			W	C Min.	E Max.	L Max.	X			Loose Piece	Tape Mounted		
26-22 202-810 [0.10-0.41]	.020 0.51	2	.182	.211	.542	.647	.100	Yellow	.082 2.08	321206*	—		
		M2	4.62	5.36	13.77	16.43	2.54						
		6	M3.5	.277	.308	.643	.783	.130	Yellow	.082 2.08	330250	—	
				7.04	7.82	16.33	19.89	3.30					
		22-16 509-3,260 [0.26-1.65]	.033 0.84	2	.182	.203	.607	.727	.115	Red	.125 3.18	325148	—
				M2	4.62	5.16	15.42	18.47	2.92				
4	M2			.237	.237	.643	.796	.143	Red	.140 3.56	2-327968-1	—	
				6.02	6.02	16.33	20.22	3.63					
4	M3			.237	.404	.810	1.015	.195	Red	.140 3.56	327962	—	
				6.02	10.26	20.57	25.78	4.95					
5	M3			.250	.187	.591	.736	.140	Red	.140 3.56	55777-1	—	
				6.35	4.75	15.01	18.69	3.56					
5	M3			.277	.277	.702	.855	.143	Red	.140 3.56	2-327950-1	—	
				7.04	7.04	17.83	21.72	3.63					
6	M3.5			.237	.404	.810	1.015	.195	Red	.140 3.56	2-327956-1	—	
				6.02	10.26	20.57	25.78	4.95					
6	M3.5			.250	.312	.716	.846	.125	Red	.125 3.18	320629	2-320629-1	
				6.35	7.92	18.19	21.49	3.18					
6	M3.5			.250	.312	.716	.846	.125	Red	.140 3.56	33476*	2-33476-1	
				6.35	7.92	18.19	21.49	3.18					
6	M3.5			.302	.465	.872	1.109	.227	Red	.140 3.56	2-327938-1	2-327938-2	
				7.67	11.81	22.15	28.17	5.77					
8	M4	.302	.465	.872	1.109	.227	Red	.140 3.56	327944*	2-327944-2			
		7.67	11.81	22.15	28.17	5.77							
8	M4	.390	.621	1.039	1.359	.310	Red	.140 3.56	327932	—			
		9.91	15.77	26.39	34.52	7.87							
10	M4	.312	.281	.685	.893	.203	Red	.140 3.56	320209*	—			
		7.92	7.14	17.40	22.68	5.16							
16-14 2,050-5,180 [1.04-2.62]	.033 0.84	4	.237	.237	.643	.796	.143	Blue	.150 3.81	2-327970-4	—		
			6.02	6.02	16.33	20.22	3.63						
		4	M3	.237	.404	.810	1.015	.195	Blue	.150 3.81	2-327964-4	—	
				6.02	10.26	20.57	25.78	4.95					
		5	M3	.244	.312	.716	.856	.125	Blue	.150 3.81	—	55694-1 ¹	
				6.20	7.92	18.19	21.74	3.18					
5	M3	.277	.277	.702	.855	.143	Blue	.150 3.81	2-327952-2	—			
		7.04	7.04	17.83	21.72	3.63							

*Available in small packaging quantities.

¹Insulation—Vinyl

²Terminal Body— Brass per MIL-C-50.

Note: "C" dimension applies from edge of metal wire barrel to center of stud hole.



PIDG (Pre-Insulated Diamond Grip) (Continued)

Rectangular Tongue Terminals (Continued)

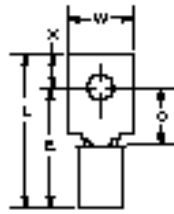

Material

Insulation — Nylon except where noted.
Terminal Body and Metallic Sleeve — Copper per ASTM B-152
Plating — Tin per ASTM B-545

Related Product Data

Insulation Color Code — pg. 4
Packaging Quantities — pg. 4
Performance Specifications — pgs. 4 & 5
Application Tooling — pg. 72

Wire Size Circular Mils [mm ²]	Tongue Material Thickness Max.	Stud Size	Dimensions					Terminal Insulation Color	Wire Insulation Diameter Max.	Part Numbers		
			W	C Min.	E Max.	L Max.	X			Loose Piece	Tape Mounted	
16-14 2,050-5,180 [1.04-2.62]	.033 0.84	6 M3.5	.237 6.02	.404 10.26	.810 20.57	1.015 25.78	.195 4.95	Blue	.150 3.81	2-327958-4	—	
			.237 6.02	.404 10.26	.810 20.57	1.015 25.78	.195 4.95	Blue	.170 4.32	2-327958-1	—	
			.244 6.20	.312 7.92	.716 18.19	.856 21.74	.125 3.18	Blue	.150 3.81	33172	—	
			.244 6.20	.312 7.92	.716 18.19	.856 21.74	.125 3.18	Blue	.170 4.32	33173*	—	
			.296 7.52	.203 5.16	.607 15.42	.752 19.10	.140 3.56	Blue	.150 3.81	33168	—	
			.302 7.67	.465 11.81	.872 22.15	1.109 28.17	.227 5.77	Blue	.150 3.81	2-327940-4	—	
		8 M4	.244 6.20	.312 7.92	.716 18.19	.856 21.74	.125 3.18	Blue	.170 4.32	35279	—	
			.296 7.52	.343 8.71	.747 18.97	.939 23.85	.187 4.75	Blue	.170 4.32	321283*	—	
			.302 7.67	.465 11.81	.872 22.15	1.109 28.17	.227 5.77	Blue	.150 3.81	2-327946-4	—	
			.390 9.91	.621 15.77	1.039 26.39	1.359 34.52	.310 7.87	Blue	.150 3.81	2-327934-2	—	
			10	.312 7.92	.281 7.14	.685 17.40	.940 23.88	.250 6.35	Blue	.170 4.32	324603	—
				4	.237 6.02	.237 6.02	.831 21.11	.984 24.99	.143 3.63	Yellow	.230 5.84	327972
		.237 6.02	.404 10.26		.998 25.35	1.203 30.56	.195 4.95	Yellow	.230 5.84	327966	—	
		5 M3	.277 7.04		.277 7.04	.889 22.58	1.042 26.47	.143 3.63	Yellow	.230 5.84	327954	2-327954-2
			.237 6.02		.404 10.26	.998 25.35	1.203 30.56	.195 4.95	Yellow	.230 5.84	2-327960-1	2-327960-2
		6 M3.5	.250 6.35		.302 7.67	.893 22.68	1.085 27.56	.187 4.75	Yellow	.230 5.84	329697	—
			.290 7.37		.218 5.54	.809 20.55	.954 24.23	.140 3.56	Yellow	.230 5.84	34512	—
		8 M4	.302 7.67	.465 11.81	1.044 26.52	1.281 32.54	.227 5.77	Yellow	.230 5.84	327942	—	
.302 7.67	.465 11.81		1.044 26.52	1.281 32.54	.227 5.77	Yellow	.230 5.84	327948	—			
.302 7.67	.465 11.81		1.077 27.36	1.247 31.67	.160 4.06	Yellow	.230 5.84	331268	2-331268-1			
.390 9.91	.621 15.77		1.211 30.76	1.531 38.89	.310 7.87	Yellow	.230 5.84	327936	—			

*Available in small packaging quantities.
Note: "C" dimension applies from edge of metal wire barrel to center of stud hole.



PIDG (Pre-Insulated Diamond Grip) (Continued)

PIDG

Rectangular Tongue Terminals

(Insulation Restricting)

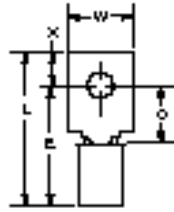

Material

Insulation — Nylon, UL 94V-2
Terminal Body — Copper per ASTM B-152
Plating — Tin per ASTM B-545
Metallic Sleeve — Copper per ASTM B-152
Plating — Nickel per QQ-N-290

Related Product Data

Insulation Color Code — pg. 4
Packaging Quantities — pg. 4
Performance Specifications — pgs. 4 & 5
Application Tooling — pg. 72

Wire Size Circular Mills [mm ²]	Tongue Material Thickness Max.	Stud Size	Dimensions					Terminal Insulation Color Solid/Stripe	Wire Insulation Diameter Range	Part Numbers	
			W	C Min.	E Max.	L Max.	X			Loose Piece	
24 475 [0.24]	.020 0.51	6 M3.5	.312 7.92	.308 7.82	.683 17.35	.875 22.23	.187 4.75	Yellow/Blue	.031-.055 0.79-1.40	2-326876-2	
10 12,066 [6.11]	.042 1.07	5 M3	.277 7.04	.277 7.04	.934 23.72	1.087 27.61	.143 3.63	Yellow/Brown	.119-.200 3.02-5.08	53912-2	
		8 M4	.390 9.91	.621 15.77	1.276 32.41	1.596 40.54	.310 7.87	Yellow/Brown	.119-.200 3.02-5.08	53914-2	

Note: "C" dimension applies from edge of metal wire barrel to center of stud hole.

Spade Tongue Terminals

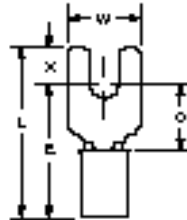

Material

Insulation — Nylon, UL 94V-2
Terminal Body and Metallic Sleeve — Copper per ASTM B-152
Plating — Tin per ASTM B-545

Related Product Data

Insulation Color Code — pg. 4
Packaging Quantities — pg. 4
Performance Specifications — pgs. 4 & 5
Application Tooling — pg. 72

Wire Size Circular Mills [mm ²]	Tongue Material Thickness Max.	Stud Size	Dimensions					Terminal Insulation Color	Wire Insulation Diameter Max.	Part Numbers	
			W	C Min.	E Max.	L Max.	X			Loose Piece	Tape Mounted
26-24 238-475 [0.12-0.24]	.029 0.74	6 M3.5	.250 6.35	.211 5.36	.632 16.05	.709 18.01	.072 1.83	Yellow	.095 2.41	—	53115-2
26-22 202-810 [0.10-0.41]	.020 0.51	0	.125 3.18	.078 1.98	.409 10.39	.476 12.09	.062 1.57	Yellow	.082 2.08	322001	—
		4	.203 5.16	.211 5.36	.542 13.77	.627 15.93	.076 1.93	Yellow	.082 2.08	321035*	2-321035-1
22-16 509-3,260 [0.26-1.65]	.033 0.84	2 M2	.182 4.62	.203 5.16	.607 15.42	.727 18.47	.115 2.92	Red	.140 3.56	328394*	2-328394-1
		4	.218 5.54	.156 3.96	.560 14.22	.674 17.12	.109 2.77	Red	.125 3.18	1-327717-0	—
			.218 5.54	.156 3.96	.560 14.22	.674 17.12	.109 2.77	Red	.140 3.56	327717*	1-327717-2
		6	.250 6.35	.312 7.92	.716 18.19	.846 21.49	.125 3.18	Red	.140 3.56	34541*	2-34541-1
			.297 7.54	.203 5.16	.607 15.42	.753 19.13	.141 3.58	Red	.125 3.18	34080*	2-34080-1
		6 M3.5	.297 7.54	.203 5.16	.607 15.42	.753 19.13	.141 3.58	Red	.140 3.56	326861*	2-326861-1
			.344 8.74	.218 5.54	.622 15.80	.783 19.89	.156 3.96	Red	.125 3.18	32403	—
		8	.344 8.74	.218 5.54	.622 15.80	.783 19.89	.156 3.96	Red	.140 3.56	32404	2-32404-1
			.375 9.53	.312 7.92	.716 18.19	.908 23.06	.187 4.75	Red	.125 3.18	32050*	2-32050-1
		8 M4	.375 9.53	.312 7.92	.716 18.19	.908 23.06	.187 4.75	Red	.140 3.56	32053*	2-32053-1
10	.375 9.53		.312 7.92	.716 18.19	.908 23.06	.187 4.75	Red	.125 3.18	32051*	2-32051-1	
	.375 9.53	.312 7.92	.716 18.19	.908 23.06	.187 4.75	Red	.140 3.56	32054*	2-32054-1		

*Available in small packaging quantities.

Note: "C" dimension applies from edge of metal wire barrel to center of stud hole.

PIDG (Pre-Insulated Diamond Grip) (Continued)

Spade Tongue Terminals (Continued)

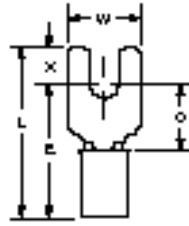

Material

Insulation — Nylon, UL 94V-2
Terminal Body and Metallic Sleeve — Copper per ASTM B-152
Plating — Tin per ASTM B-545

Related Product Data

Insulation Color Code — pg. 4
Packaging Quantities — pg. 4
Performance Specifications — pgs. 4 & 5
Application Tooling — pg. 72

Wire Size Circular Mills [mm ²]	Tongue Material Thickness Max.	Stud Size	Dimensions					Terminal Insulation Color	Wire Insulation Diameter Max.	Part Numbers			
			W	C Min.	E Max.	L Max.	X			Loose Piece	Tape Mounted		
16-14 2,050-5,180 [1.04-2.62]	.033 0.84	6 M3.5	.244 6.20	.312 7.92	.716 18.19	.846 21.49	.125 3.18	Blue	.170 4.32	328281*	1-328281-1		
			.297 7.54	.203 5.16	.607 15.42	.753 19.13	.141 3.58	Blue	.170 4.32	35559*	2-35559-1		
			.385 9.78	.312 7.92	.716 18.19	.908 23.06	.187 4.75	Blue	.170 4.32	32058*	—		
		8 M4	.297 7.54	.203 5.16	.607 15.42	.753 19.13	.141 3.58	Blue	.170 4.32	321233*	2-321233-1		
			.312 7.92	.375 9.53	.779 19.79	1.034 26.26	.250 6.35	Blue	.170 4.32	325199	—		
			.385 9.78	.312 7.92	.716 18.19	.908 23.06	.187 4.75	Blue	.150 3.81	32056*	2-32056-1		
			.385 9.78	.312 7.92	.716 18.19	.908 23.06	.187 4.75	Blue	.170 4.32	32059*	2-32059-1		
			10	.385 9.78	.312 7.92	.716 18.19	.908 23.06	.187 4.75	Blue	.150 3.81	32057	—	
				.385 9.78	.312 7.92	.716 18.19	.908 23.06	.187 4.75	Blue	.170 4.32	32060*	2-32060-1	
		12-10 5,180-13,100 [2.62-6.64]	.042 1.07	6 M3.5	.290 7.37	.218 5.54	.809 20.55	.954 24.23	.140 3.56	Yellow	.230 5.84	322985*	1-322985-0
					.312 7.92	.296 7.52	.887 22.53	1.095 27.81	.203 5.16	Yellow	.230 5.84	326859*	2-326859-1
				8 M4	.312 7.92	.468 11.89	1.059 26.90	1.314 33.38	.250 6.35	Yellow	.230 5.84	325197	—
.406 10.31	.296 7.52				.887 22.53	1.095 27.81	.203 5.16	Yellow	.230 5.84	32588*	2-32588-1		
.406 10.31	.296 7.52				.887 22.53	1.095 27.81	.203 5.16	Yellow	.250 6.35	35152*	2-35152-1		
.406 10.31	.296 7.52				.887 22.53	1.095 27.81	.203 5.16	Yellow	.230 5.84	32589*	2-32589-1		

*Available in small packaging quantities.

Note: "C" dimension applies from edge of metal wire barrel to center of stud hole.



PIDG (Pre-Insulated Diamond Grip) (Continued)

Flanged Spade Tongue Terminals

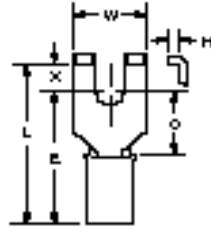

Material

Insulation — Nylon, UL 94V-2
Terminal Body and Metallic Sleeve — Copper per ASTM B-152
Plating — Tin per ASTM B-545

Related Product Data

Insulation Color Code — pg. 4
Packaging Quantities — pg. 4
Performance Specifications — pgs. 4 & 5
Application Tooling — pg. 72

PIDG

Wire Size Circular Mills [mm ²]	Tongue Material Thickness Max.	Stud Size	Dimensions						Terminal Insulation Color	Wire Insulation Diameter Max.	Part Numbers	
			W	C Min.	E Max.	L Max.	X	H Min.			Loose Piece	Tape Mounted
26-22 202-810 [0.10-0.41]	.020 0.51	2 M2	.182 4.62	.203 5.16	.534 13.56	.649 16.48	.110 2.79	.026 0.66	Yellow	.082 2.08	324597*	2-324597-1
		4	.193 4.90	.203 5.16	.534 13.56	.649 16.48	.110 2.79	.026 0.66	Yellow	.082 2.08	52369*	52369-1
		6 M3.5	.250 6.35	.203 5.16	.534 13.56	.649 16.48	.110 2.79	.026 0.66	Yellow	.082 2.08	51874*	51874-1
22-16 509-3,260 [0.26-1.65]	.033 0.84	2 M2	.182 4.62	.203 5.16	.607 15.42	.727 18.47	.115 2.92	.041 1.04	Red	.125 3.18	2-324608-2	—
			.182 4.62	.203 5.16	.607 15.42	.727 18.47	.115 2.92	.041 1.04	Red	.140 3.56	324608*	2-324608-1
			.250 6.35	.203 5.16	.607 15.42	.737 18.72	.125 3.18	.046 1.17	Red	.125 3.18	322777*	2-322777-1
			.265 6.73	.203 5.16	.607 15.42	.737 18.72	.125 3.18	.046 1.17	Red	.140 3.56	322426	—
		6 M3.5	.296 7.52	.203 5.16	.607 15.42	.737 18.72	.125 3.18	.046 1.17	Red	.125 3.18	32561*	2-32561-1
			.296 7.52	.203 5.16	.607 15.42	.737 18.72	.125 3.18	.046 1.17	Red	.140 3.56	32562*	2-32562-1
			.328 8.33	.203 5.16	.607 15.42	.737 18.72	.125 3.18	.046 1.17	Red	.140 3.56	324557	2-324557-1
			.296 7.52	.203 5.16	.607 15.42	.737 18.72	.125 3.18	.046 1.17	Red	.140 3.56	2-32562-2	2-32562-3
		8 M4	.416 10.57	.250 6.35	.654 16.61	.830 21.08	.171 4.34	.062 1.57	Red	.125 3.18	32497	2-32497-1
			.416 10.57	.250 6.35	.654 16.61	.830 21.08	.171 4.34	.062 1.57	Red	.140 3.56	32498*	2-32498-1
		10	.296 7.52	.203 5.16	.607 15.42	.737 18.72	.125 3.18	.046 1.17	Red	.140 3.56	1-331366-0	1-331366-1
		16-14 2,050-5,180 [1.04-2.62]	.033 0.84	6 M3.5	.294 7.47	.203 5.16	.607 15.42	.737 18.72	.125 3.18	.047 1.19	Blue	.150 3.81
	.294 7.47			.203 5.16	.607 15.42	.737 18.72	.125 3.18	.047 1.19	Blue	.170 4.32	320861*	2-320861-1
	.328 8.33			.203 5.16	.607 15.42	.737 18.72	.125 3.18	.047 1.19	Blue	.170 4.32	324567*	—
	.294 7.47			.203 5.16	.607 15.42	.737 18.72	.125 3.18	.047 1.19	Blue	.170 4.32	320862*	2-320862-1
8 M4	.416 10.57			.250 6.35	.654 16.61	.830 21.08	.171 4.34	.062 1.57	Blue	.150 3.81	33155*	—
	.416 10.57			.250 6.35	.654 16.61	.830 21.08	.171 4.34	.062 1.57	Blue	.170 4.32	33156	2-33156-1
12-10 5,180-13,100 [2.62-6.64]	.042 1.07	10	.294 7.47	.203 5.16	.607 15.42	.737 18.72	.125 3.18	.052 1.19	Blue	.170 4.32	320863*	2-320863-2
			.296 7.52	.250 6.35	.841 21.36	1.017 25.83	.171 4.34	.052 1.32	Yellow	.230 5.84	324577	1-324577-0
		6 M3.5	.296 7.52	.250 6.35	.841 21.36	1.017 25.83	.171 4.34	.052 1.32	Yellow	.250 6.35	325150*	—
			.328 8.33	.250 6.35	.841 21.36	1.017 25.83	.171 4.34	.052 1.32	Yellow	.230 5.84	324587	—
		8 M4	.416 10.57	.250 6.35	.841 21.36	1.017 25.83	.171 4.34	.052 1.32	Yellow	.230 5.84	32510*	2-32510-1
			.416 10.57	.250 6.35	.841 21.36	1.017 25.83	.171 4.34	.052 1.32	Yellow	.230 5.84	326865	2-326865-1
	.416 10.57	.250 6.35	.841 21.36	1.017 25.83	.171 4.34	.052 1.32	Yellow	.250 6.35	324015*	2-324015-1		

*Available in small packaging quantities.

Note: "C" dimension applies from edge of metal wire barrel to center of stud hole.



PIDG (Pre-Insulated Diamond Grip) (Continued)

Short Spring Spade Tongue Terminals

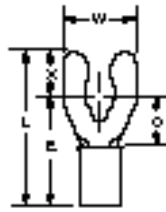

Material

Insulation — Nylon, UL 94V-2
Terminal Body — Phosphor Bronze per ASTM B-139
Metallic Sleeve — Copper per ASTM B-152
Plating — Tin per ASTM B-545

Related Product Data

Insulation Color Code — pg. 4
Packaging Quantities — pg. 4
Performance Specifications — pgs. 4 & 5
Application Tooling — pg. 72

Wire Size Circular Mills [mm ²]	Tongue Material Thickness Max.	Stud Size	Dimensions					Terminal Insulation Color	Wire Insulation Diameter Max.	Part Numbers			
			W	C Min.	E Max.	L Max.	X			Loose Piece	Tape Mounted		
26-22 202-810 [0.10-0.41]	.020 0.51	2 M2	.171 4.34	.206 5.23	.537 13.64	.651 16.54	.109 2.77	Yellow	.082 2.08	52921*	52921-1		
		4	.203 5.16	.219 5.56	.550 13.97	.695 17.65	.140 3.56	Yellow	.082 2.08	52922*	52922-1		
		5 M3	.250 6.35	.203 5.16	.534 13.56	.679 17.25	.140 3.56	Yellow	.082 2.08	52923	52923-1		
		6 M3.5	.250 6.35	.203 5.16	.534 13.56	.679 17.25	.140 3.56	Yellow	.082 2.08	52924*	52924-1		
		8 M4	.375 9.53	.281 7.14	.612 15.54	.787 19.99	.170 4.32	Yellow	.082 2.08	52925	52925-1		
22-16 509-3.260 [0.26-1.65]	.033 0.84	4	.203 5.16	.250 6.35	.654 16.61	.799 20.29	.140 3.56	Red	.125 3.18	52927*	52927-1		
		5 M3	.250 6.35	.250 6.35	.654 16.61	.799 20.29	.140 3.56	Red	.125 3.18	52928*	52928-1		
		6 M3.5	.250 6.35	.250 6.35	.654 16.61	.799 20.29	.140 3.56	Red	.125 3.18	52929*	52929-1		
			.250 6.35	.250 6.35	.654 16.61	.799 20.29	.140 3.56	Red	.140 3.56	—	52929-3		
		8 M4	.244 6.20	.281 7.14	.725 18.42	.895 22.73	.170 4.32	Red	.140 3.56	—	55768-1		
			.375 9.53	.281 7.14	.685 17.40	.860 21.84	.170 4.32	Red	.125 3.18	52930*	52930-1		
		10	.375 9.53	.281 7.14	.685 17.40	.860 21.84	.170 4.32	Red	.140 3.56	—	52930-3		
			.406 10.31	.281 7.14	.685 17.40	.908 23.06	.218 5.54	Red	.125 3.18	52931*	52931-1		
		1/4 M6	.406 10.31	.281 7.14	.685 17.40	.908 23.06	.218 5.54	Red	.140 3.56	—	52931-3		
			.625 15.88	.343 8.71	.747 18.97	1.033 26.24	.281 7.14	Red	.125 3.18	52933*	—		
16-14 2,050-5,180 [1.04-2.62]	.033 0.84	5 M3	.250 6.35	.250 6.35	.654 16.61	.799 20.29	.140 3.56	Blue	.170 4.32	52934*	52934-1		
		6 M3.5	.250 6.35	.250 6.35	.654 16.61	.799 20.29	.140 3.56	Blue	.170 4.32	52935*	52935-1		
			.250 6.35	.250 6.35	.654 16.61	.799 20.29	.140 3.56	Blue	.182 4.62	52935-2*	52935-3		
		8 M4	.375 9.53	.281 7.14	.685 17.40	.860 21.84	.170 4.32	Blue	.170 4.32	52936*	52936-1		
			.375 9.53	.281 7.14	.685 17.40	.860 21.84	.170 4.32	Blue	.182 4.62	52936-2	52936-3		
		10	.406 10.31	.281 7.14	.685 17.40	.908 23.06	.218 5.54	Blue	.170 4.32	52937*	52937-1		
			.406 10.31	.281 7.14	.685 17.40	.908 23.06	.218 5.54	Blue	.182 4.62	52937-2*	52937-3		
		1/4 M6	.625 15.88	.343 8.71	.747 18.97	1.033 26.24	.281 7.14	Blue	.170 4.32	52939	—		
		12-10 5,180-13,100 [2.62-6.64]	.042 1.07	5 M3	.250 6.35	.169 4.29	.770 19.56	.959 24.36	.184 4.67	Yellow	.250 6.35	52940*	52940-1
				6 M3.5	.250 6.35	.174 4.42	.775 19.69	.959 24.36	.179 4.55	Yellow	.250 6.35	52941*	52941-1
8 M4	.375 9.53			.276 7.01	.877 22.28	1.052 26.72	.170 4.32	Yellow	.250 6.35	52942*	52942-1		
10	.406 10.31			.276 7.01	.877 22.28	1.100 27.94	.218 5.54	Yellow	.250 6.35	52943*	52943-1		
1/4 M6	.625 15.88			.338 8.59	.939 23.85	1.225 31.12	.281 7.14	Yellow	.250 6.35	52945*	—		

*Available in small packaging quantities.

Note: "C" dimension applies from edge of metal wire barrel to center of stud hole.



PIDG (Pre-Insulated Diamond Grip) (Continued)

**Long Spring Spade
Tongue Terminals**

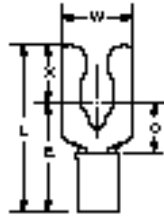

Material

Insulation — Nylon, UL 94V-2
Terminal Body — Phosphor Bronze per ASTM B-139
Metallic Sleeve — Copper per ASTM B-152
Plating — Tin per ASTM B-545

Related Product Data

Insulation Color Code — pg. 4
Packaging Quantities — pg. 4
Performance Specifications — pgs. 4 & 5
Application Tooling — pg. 72

PIDG

Wire Size Circular Mils [mm ²]	Tongue Material Thickness Max.	Stud Size	Dimensions					Terminal Insulation Color	Wire Insulation Diameter Max.	Part Numbers	
			W	C Min.	E Max.	L Max.	X			Loose Piece	Tape Mounted
26-22 202-810 [0.10-0.41]	.020 0.51	6	.250	.235	.566	.847	.276	Yellow	.082 2.08	52403	52403-1
		M3.5	6.35	5.97	14.38	21.51	7.01				
22-16 509-3,260 [0.26-1.65]	.033 0.84	4	.203	.201	.615	.896	.276	Red	.125 3.18	52408	—
		M3.5	5.16	5.11	15.62	22.76	7.01				
		6	.250	.238	.652	.933	.276	Red	.125 3.18	52409*	52409-1
			M3.5	6.35	6.05	16.56	23.70				
		8	.250	.238	.652	.933	.276	Red	.140 3.56	52409-2	52409-3
			M4	6.35	6.05	16.56	23.70				
10	.281	.270	.684	.979	.290	Red	.125 3.18	52410*	52410-1		
	M4	7.14	6.86	17.37	24.87					7.37	
16-14 2,050-5,180 [1.04-2.62]	.033 0.84	6	.250	.238	.652	.933	.276	Blue	.150 3.81	52420*	52420-2
			M3.5	6.35	6.05	16.56	23.70				
		8	.250	.238	.652	.933	.276	Blue	.170 4.32	52420-1*	52420-3
			M3.5	6.35	6.05	16.56	23.70				
		10	.281	.270	.684	.979	.290	Blue	.150 3.81	52421*	—
			M4	7.14	6.86	17.37	24.87				
		10	.281	.270	.684	.979	.290	Blue	.170 4.32	52421-1*	52421-3
			M4	7.14	6.86	17.37	24.87				
		1/4 M6	.343	.283	.697	1.005	.303	Blue	.170 4.32	52422-1*	52422-3
			M6	8.71	7.19	17.70	25.53				
12-10 5,180-13,100 [2.62-6.64]	.042 1.07	6	.437	.345	.759	1.102	.338	Blue	.150 3.81	52423	52423-2
			M6	11.10	8.76	19.28	27.99				
		6	.312	.242	.843	1.131	.283	Yellow	.230 5.84	52430	52430-2
			M3.5	7.92	6.15	21.41	28.73				
		8	.312	.242	.843	1.131	.283	Yellow	.250 6.35	52430-1	52430-3
			M3.5	7.92	6.15	21.41	28.73				
		8	.375	.273	.874	1.174	.295	Yellow	.250 6.35	52431-1	52431-3
			M4	9.53	6.93	22.20	29.82				
		10	.375	.305	.906	1.219	.308	Yellow	.230 5.84	—	52432-2
			M4	9.53	7.75	23.01	30.96				
10	.375	.305	.906	1.219	.308	Yellow	.250 6.35	52432-1	52432-3		
	M4	9.53	7.75	23.01	30.96					7.82	
1/4 M6	.437	.345	.946	1.289	.338	Yellow	.250 6.35	52433-1	—		
	M6	11.10	8.76	24.03	32.74					8.59	

*Available in small packaging quantities.

Note: "C" dimension applies from edge of metal wire barrel to center of stud hole.



PIDG (Pre-Insulated Diamond Grip) (Continued)

Slotted Ring Tongue Terminals

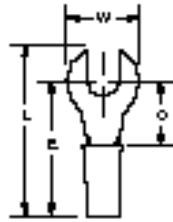

Material

Insulation — Nylon except where noted.
Terminal Body and Metallic Sleeve — Copper per ASTM B-152
Plating — Tin per ASTM B-545

Related Product Data

Insulation Color Code — pg. 4
Packaging Quantities — pg. 4
Performance Specifications — pgs. 4 & 5
Application Tooling — pg. 72

Wire Size Circular Mills [mm ²]	Tongue Material Thickness Max.	Stud Size	Dimensions				Terminal Insulation Color	Wire Insulation Diameter Max.	Part Numbers	
			W	C Min.	E Max.	L Max.			Loose Piece	Tape Mounted
26-22 202-810 [0.10-0.41]	.020 0.51	6	.250	.281	.612	.719	Yellow	.082 2.08	323011	2-323011-2
		M3.5	6.35	7.14	15.54	18.26				
22-16 509-3,260 [0.26-1.65]	.033 0.84	6	.312	.281	.685	.828	Red	.140 3.56	35216*	2-35216-1
		M3.5	7.92	7.14	17.40	21.03				
		8	.281	.250	.654	.770	Red	.140 3.56	36954*	2-36954-2
		M4	7.14	6.35	16.61	19.56				
10	.312	.281	.685	.812	Red	.125 3.18	331453	1-331453-0		
M4	7.92	7.14	17.40	20.62						
16-14 2,050-5,180 [1.04-2.62]	.033 0.84	1/4	.469	.437	.841	1.039	Red	.125 3.18	321808	—
		M6	11.91	11.10	21.36	26.39				
16-14 HD 2,050-5,180 [1.04-2.62]	.048 1.22	6	.343	.281	.685	.844	Blue	.170 4.32	34406	—
		M3.5	8.71	7.14	17.40	21.44				
16-14 HD 2,050-5,180 [1.04-2.62]	.048 1.22	8	.344	.281	.685	.837	Blue	.170 4.32	35440	—
		M4	8.74	7.14	17.40	21.26				
16-14 HD 2,050-5,180 [1.04-2.62]	.048 1.22	3/8	.750	.625	1.216	1.594	Yellow/Black	.250 6.35	696077-2	696077-1
		M6	19.05	15.88	30.89	40.49				
12-10 5,180-13,100 [2.62-6.64]	.042 1.07	1/4	.531	.468	1.156	1.390	Yellow	.300 7.62	321611 ¹	—
		M6	13.49	11.89	29.36	35.31				
12-10 5,180-13,100 [2.62-6.64]	.040 1.02	3/8	.750	.625	1.216	1.594	Yellow	.250 6.35	696076-2	696076-1
		M6	19.05	15.88	30.89	40.49				

*Available in small packaging quantities.

¹Insulation—Vinyl.

Note: "C" dimension applies from edge of metal wire barrel to center of stud hole.

Hook Tongue Terminals

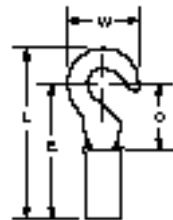

Material

Insulation — Nylon except where noted.
Terminal Body and Metallic Sleeve — Copper per ASTM B-152
Plating — Tin per ASTM B-545

Related Product Data

Insulation Color Code — pg. 4
Packaging Quantities — pg. 4
Performance Specifications — pgs. 4 & 5
Application Tooling — pg. 72

Wire Size Circular Mills [mm ²]	Tongue Material Thickness Max.	Stud Size	Dimensions				Terminal Insulation Color	Wire Insulation Diameter Max.	Part Numbers	
			W	C Min.	E Max.	L Max.			Loose Piece	Tape Mounted
22-16 509-3,260 [0.26-1.65]	0.84 .033	6	.281	.203	.607	.750	Red	.140 3.56	34313*	—
		M3.5	7.14	5.16	15.42	19.05				
22-16 509-3,260 [0.26-1.65]	0.84 .033	8	.343	.296	.705	.879	Red	.140 3.56	32456	—
		M4	8.71	7.52	17.91	22.33				
16-14 2,050-5,180 [1.04-2.62]	.033 0.84	6	.343	.281	.685	.859	Blue	.150 3.81	320381	2-320381-1
		M3.5	8.71	7.14	17.40	21.82				
16-14 2,050-5,180 [1.04-2.62]	.033 0.84	8	.343	.281	.685	.859	Blue	.170 4.32	320306*	2-320306-1
		M4	8.71	7.14	17.40	21.82				
16-14 2,050-5,180 [1.04-2.62]	.033 0.84	10	.343	.281	.685	.859	Blue	.170 4.32	35481 ¹	—
		M4	8.71	7.14	17.40	21.82				

*Available in small packaging quantities.

¹Insulation—Vinyl.

Note: "C" dimension applies from edge of metal wire barrel to center of stud hole.



PIDG (Pre-Insulated Diamond Grip) (Continued)

PIDG

Multiple Stud Terminals

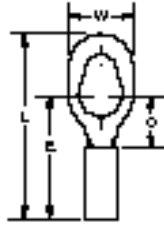

Material

Insulation — Nylon, UL 94V-2
Terminal Body — Copper per ASTM B-152
Plating — Tin per ASTM B-545
Metallic Sleeve — Copper per ASTM B-152
Plating — Nickel per QQ-N-290

Related Product Data

Insulation Color Code — pg. 4
Packaging Quantities — pg. 4
Performance Specifications — pgs. 4 & 5
Application Tooling — pg. 72

Wire Size Circular Mills [mm ²]	Tongue Material Thickness Max.	Stud Size	Dimensions				Terminal Insulation Color	Wire Insulation Diameter Max.	Part Numbers	
			W	C Min.	E Max.	L Max.			Loose Piece	Tape Mounted
22-16 509-3,260 [0.26-1.65]	.033 0.84	6-8-10	.325 8.26	.281 7.14	.685 17.40	.957 24.31	Red	.125 3.18	54771-1*	54771-2
12-10 5,180-13,100 [2.62-6.64]	.042 1.07	6-8-10	.325 8.26	.302 7.67	.893 22.68	1.165 29.59	Yellow	.230 5.84	54773-1*	—

*Available in small packaging quantities.
Note: "C" dimension applies from edge of metal wire barrel to center of stud hole.

Offset Ring Tongue Terminals

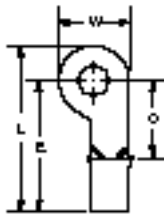

Material

Insulation — Nylon, UL 94V-2
Terminal Body and Metallic Sleeve — Copper per ASTM B-152
Plating — Tin per ASTM B-545

Related Product Data

Insulation Color Code — pg. 4
Packaging Quantities — pg. 4
Performance Specifications — pgs. 4 & 5
Application Tooling — pg. 72

Wire Size Circular Mills [mm ²]	Tongue Material Thickness Max.	Stud Size	Dimensions				Terminal Insulation Color	Wire Insulation Diameter Max.	Part Numbers
			W	C Min.	E Max.	L Max.			Loose Piece
22-16 509-3,260 [0.26-1.65]	.033 0.84	6	.375 9.53	.312 7.92	.716 18.19	.906 23.01	Red	.125 3.18	323039
		M3.5	.375 9.53	.312 7.92	.716 18.19	.906 23.01	Red	.125 3.18	324011
16-14 2,050-5,180 [1.04-2.62]	.033 0.84	6	.375 9.53	.312 7.92	.716 18.19	.906 23.01	Blue	.150 3.81	323817
		M3.5	.375 9.53	.312 7.92	.716 18.19	.906 23.01	Blue	.150 3.81	323818

Note: "C" dimension applies from edge of metal wire barrel to center of stud hole.



PIDG (Pre-Insulated Diamond Grip) (Continued)

Offset Ring Tongue Terminals
(Insulation Restricting)

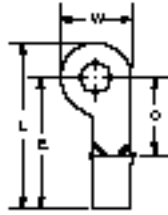

Material

Insulation — Nylon, UL 94V-2
Terminal Body and Metallic Sleeve — Copper per ASTM B-152
Plating — Tin per ASTM B-545

Related Product Data

Insulation Color Code — pg. 4
Packaging Quantities — pg. 4
Performance Specifications — pgs. 4 & 5
Application Tooling — pg. 72

Wire Size Circular Mils [mm ²]	Tongue Material Thickness Max.	Stud Size	Dimensions				Terminal Insulation Color Solid/Stripe	Wire Insulation Diameter Range	Part Numbers Loose Piece
			W	C Min.	E Max.	L Max.			
22 754 [0.38]	.033 0.84	6 M3.5	.375 9.53	.312 7.92	.758 19.25	.946 24.03	Red/Green	.038-.110 0.97-2.79	52284-4
20 1,186 [0.60]	.033 0.84	6 M3.5	.375 9.53	.312 7.92	.758 19.25	.946 24.03	Red/Red	.046-.110 1.17-2.79	52284-2
		10	.375 9.53	.312 7.92	.758 19.25	.946 24.03	Red/Red	.046-.110 1.17-2.79	52284-3
16 2,800 [1.42]	.033 0.84	6 M3.5	.375 9.53	.312 7.92	.748 19.00	.938 23.83	Blue/Blue	.063-.130 1.60-3.30	52283-2
14 4,234 [2.15]	.033 0.84	10	.375 9.53	.312 7.92	.748 19.00	.938 23.83	Blue/Green	.078-.130 1.98-3.30	52283-1

Note: "C" dimension applies from edge of metal wire barrel to center of stud hole.

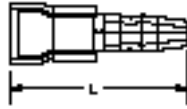
**PIDG (Pre-Insulated Diamond Grip)** (Continued)**Shur-Plug Terminal**

.156 Series

Material

Insulation — Nylon, UL 94V-2
Terminal Body and Metallic Sleeve — Copper per ASTM B-152
Plating — Tin per ASTM B-545

Related Product Data

Insulation Color Code — pg. 4
Packaging Quantities — pg. 4
Performance Specifications — pgs. 4 & 5
Application Tooling — pg. 72

Wire Size Circular Mils [mm ²]	Dimension L Max.	Terminal Insulation Color	Wire Insulation Diameter Max.	Part Numbers	
				Loose Piece	Tape Mounted
16-14 2,050-5,180 [1.04-2.62]	.790 20.07	Blue	.170 4.32	324225*	2-324225-1
16-14 Receptacle 2,050-5,180 [1.04-2.62]	.768 19.51	Blue	.157 3.99	165429-1	—

*Available in small packaging quantities.

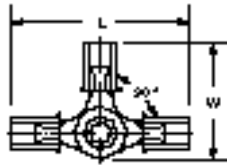
3-Way Connector Terminal**Material**

Insulation — Nylon, UL 94V-2
Terminal Body and Metallic Sleeve — Copper per ASTM B-152
Rivet — Brass per QQ-B-626
Plating — Tin per ASTM B-545

Related Product Data

Insulation Color Code — pg. 4
Packaging Quantities — pg. 4
Performance Specifications — pgs. 4 & 5
Application Tooling — pg. 72

Wire Size Circular Mils [mm ²]	Tongue Material Thickness Max.	Dimensions		Terminal Insulation Color	Wire Insulation Diameter Max.	Part Number Loose Piece
		W Max.	L Max.			
16-14 2,050-5,180 [1.04-2.62]	.033 0.84	.859 21.82	1.370 34.80	Blue	.170 4.32	53222-1*

*Available in small packaging quantities.



PIDG (Pre-Insulated Diamond Grip) (Continued)

PIDG

Tabs

Material

Insulation — Nylon, UL 94V-2
Terminal Body and Metallic Sleeve — Copper per ASTM B-152
Plating — Tin per ASTM B-545

Related Product Data

Insulation Color Code — pg. 4
Packaging Quantities — pg. 4
Performance Specifications — pgs. 4 & 5
Application Tooling — pg. 72

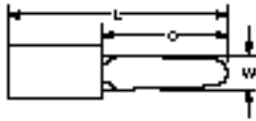

Style A

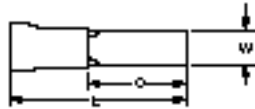

Style B

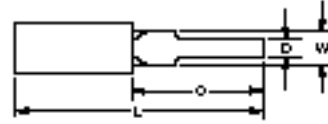

Style C

Wire Size Circular Mils [mm ²]	Tongue Material Thickness Max.	Style	Dimensions				Terminal Insulation Color	Wire Insulation Diameter Max.	Part Numbers Loose Piece
			W	C Min.	L Max.	D			
22-16 509-3,260 [0.26-1.65]	.033 0.84	A	.140 3.56	.480 12.19	.904 22.96	—	Red	.140 3.56	34294*
16-14 2,050-5,180 [1.04-2.62]	.033 0.84	B	.156 3.96	.375 9.53	.809 20.55	—	Blue	.170 4.32	327748
12-10 5,180-13,100 [2.62-6.64]	.042 1.07	C	.225 5.72	.600 15.24	1.194 30.33	.125 3.18	Yellow	.230 5.84	324543*

*Available in small packaging quantities.

Note: "C" dimension applies from edge of metal wire barrel to end of tab.



PIDG (Pre-Insulated Diamond Grip) (Continued)

PIDG

Butt Splices



Gland and Radiation Resistant

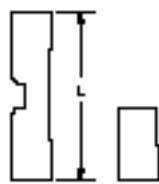

Step Down Assembly¹



Special

Material

Insulation Sleeve — Standard, Step Down Assembly and Special — Nylon Radiation Resistant — Polyvinylidene Fluoride (PVF₂)
Splice Body and Insulation Support Sleeve — Copper per ASTM B-152
Plating — Tin per ASTM B-545

Related Product Data

Insulation Color Code — pg. 4
Packaging Quantities — pg. 4
Performance Specifications — pgs. 4 & 5
Application Tooling — pg. 72

Wire Size Circular Mils ² [mm ²]	Style	Dimension L Max.	Splice Insulation Color	Wire Insulation Diameter Max.	Part Numbers	
					Loose Piece	Tape Mounted
26-24 ³ 238-475 [0.12-0.24]	Standard	.890 22.61	Yellow	.082 2.08	323994	2-323994-1
26-22 202-810 [0.10-0.41]		.890 22.61	Yellow	.082 2.08	2-323994-2*	—
24-20 320-1,290 [0.16-0.65]		1.035 26.29	Natural	.100 2.54	323975	2-323975-3
22-16 ⁴ 509-3,260 [0.26-1.65]		1.265 32.13	Red	.125 3.18	320559*	2-320559-4
16-14 2,050-5,180 [1.04-2.62]		1.265 32.13	Blue	.150 3.81	320562*	2-320562-3
12-10 5,180-13,100 [2.62-6.64]		1.656 42.06	Yellow	.220 5.59	320570*	2-320570-3 [†]
16-14 to 22-18 2,050-5,180 to 509-1,900 [1.04-2.62] [0.26-0.96]	Step Down Assembly	1.265 32.13	Blue	.150/.115 3.81/2.92	327583	2-327583-1
12-10 to 22-18 5,180-13,100 to 509-1,900 [2.62-6.64] [0.26-0.96]		1.656 42.06	Yellow	.220/.140 5.59/3.56	327639	—
12-10 to 16-14 5,180-13,100 to 2,050-5,180 [2.62-6.64] [1.04-2.62]		1.656 42.06	Yellow	.220/.170 5.59/4.32	327638	—
26-24 ³ 238-475 [0.12-0.24]	Radiation Resistant	.890 22.61	Natural w/ Yellow Stripes	.082 2.08	53546-1	—
26-22 202-810 [0.10-0.41]		.890 22.61	Natural w/ Yellow Stripes	.082 2.08	53546-3	—
24-20 320-1,290 [0.16-0.65]		1.035 26.29	Natural w/ White Stripes	.100 2.54	53547-1	53547-2
22-16 ⁴ 509-3,260 [0.26-1.65]		1.265 32.13	Natural w/ Red Stripes	.125 3.18	53548-1*	53548-2
16-14 2,050-5,180 [1.04-2.62]		1.265 32.13	Natural w/ Blue Stripes	.150 3.81	53549-1*	53549-2
12-10 5,180-13,100 [2.62-6.64]		1.656 42.06	Natural w/ Yellow Stripes	.220 5.59	53550-1*	—
12-10 5,180-13,100 [2.62-6.64]	Special	1.245 31.62	Yellow	.220 5.59	328961 [‡]	—

*Available in small packaging quantities.

¹Includes adapter insert.

²When using two or more wires in either end of a butt splice, the combined cross sectional area must be within the (CMA) circular mil area range listed.

³26-24 range in accordance with MIL-T-7928.

⁴22-16 splices are 22-18 range in accordance with MIL-T-7928.

[†]12-10 butt splice, threaded 8-32 one end.

[‡]Tapetronic only.



PIDG (Pre-Insulated Diamond Grip) (Continued)

Butt Splice Step Down Adapter Inserts¹



Material

Adapter Body — Copper per ASTM B-152
Plating — Zinc Plate / DyeChromate

Related Product Data

Insulation Color Code — pg. 4
Packaging Quantities — pg. 4
Performance Specifications — pgs. 4 & 5
Application Tooling — pg. 72

Butt Splice		Adapter Insert			
Wire Size Circular Mils [mm ²]	Part No.	Wire Size Circular Mils [mm ²]	Dimension L	Color Code	Part Numbers
16-14 2,050-5,180 [1.04-2.62]	320562	22-18	.350	Red	1-327635-1
		509-1,900 [0.26-0.96]	8.89 .402 10.21	Red	327635*
12-10 5,180-13,100 [2.62-6.64]	320570	22-18	.562	Red	327636*
		509-1,900 [0.26-0.96]	14.27		
		16-14	.562	Blue	327637*
		2,050-5,180 1.04-2.62]	14.27		

¹Available in small packaging quantities.
¹Adapter inserts can be ordered separately for use in specific Standard PIDG Butt Splices.

Knife Disconnect Splices

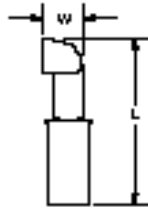

Material

Insulation — Nylon, UL 94V-2
Splice Body and Metallic Sleeve — Copper per ASTM B-152
Plating — Tin per ASTM B-545

Related Product Data

Insulation Color Code — pg. 4
Packaging Quantities — pg. 4
Performance Specifications — pgs. 4 & 5
Application Tooling — pg. 72

Wire Size Circular Mils [mm ²]	Material Thickness	Dimensions		Splice Insulation Color	Wire Insulation Diameter Max.	Part Numbers	
		W	L Max.			Loose Piece	Tape Mounted
22-16 509-3,260 [0.26-1.65]	.031 0.79	.203	.878	Red	.125	320555*	—
		5.16	22.30	Red	3.18	32446*	2-32446-1
16-14 2,050-5,180 [1.04-2.62]	.031 0.79	.203	.878	Blue	.150	320566*	—
		5.16	22.30	Blue	3.81	32448*	—
12-10 5,180-13,100 [2.62-6.64]	.040 1.02	.281	1.234	Yellow	.230	320620*	—
		7.14	31.34	Yellow	5.84	35762*	—
		.281	1.260	Yellow	.250		
		7.14	32.00		6.35		

¹Available in small packaging quantities.



PIDG FASTON

Product Facts

- Pre-insulated terminal designed for uniformed reliability in most difficult circuit environment
- Consists of an unplated or tin-plated brass body or a tin-plated phosphor bronze body with a specially designed copper sleeve and insulation sleeve fitted over the terminal barrel
- Design of the tool dies and construction of the terminal permits uniform insulation thickness under crimping pressure, transmitting this pressure evenly to the center of the crimp area

The AMP Mated Tool/Terminal Concept

- AMP compression crimping produces crimps for a given size wire and terminal that are alike in appearance and performance
- Terminal and the crimping tool are designed as uni-form matched devices
- Dies are precision-engineered from the finest hard-metal alloys
- Crimping pressure is controlled by a ratchet device on the hand tool or a corresponding pre-calibration in the crimping jaws of AMP automated crimping machines

The Crimp

- When done properly, crimping pressure can neither overstress nor under-stress the terminal barrel—machined dies fully bottom to the precise crimp height
- Resulting termination is free of contamination
- Resistant to shock and critical environments
- Tensile strength approaches that of the wire itself

Nylon Insulation. Nylon sleeve has high dielectric strength.

Color Coding. Terminal insulation is color-coded by wire range to prevent errors during installation.

Copper Sleeve. The specially designed copper sleeve, fitted over the terminal barrel, provides circumferential insulation support to the wire and allows the wire to be bent in any direction, without fraying the wire's insulation or breaking the conductor.

Funnel Ramp Entry. Prevents a turned back strand and rapid wire insertion during high speed production.

Serrations. Serrations inside barrel provide maximum contact and tensile strength after crimping.

Basic Terminal Material. The basic terminal is constructed of fine grade high conductivity brass per ASTM B-36 or phosphor bronze per ASTM B-139. The brass terminal is either unplated or tin-plated per ASTM B-545. The phosphor bronze terminal is tin-plated per ASTM B-545. AMP's special plating process creates durable corrosion resistance to salt spray and most chemical fumes.

Temperature Rating: 105°C Max.

AMP PIDG FASTON Terminals (Use Type TETRA-CRIMP*Tooling)

AMP Wire Range	Component Recognized File E 66717	LR 7189 Certified
22-18	22-18 Stranded	300 V Max., 105°C. Max. ¹
16-14	16-14 Stranded	
12-10	12-10 Stranded	

¹UL& CSA— Nylon except where noted

AMP PIDG FASTON Line Splice Connectors "250" Series

Component Recognized File E 66717	105°C Max. (Vinyl)	LR 7189 Certified	105°C Max. (Vinyl)
AMPPart No. 1-321235-0 1-321235-1	600 V Max.	AMPPart No. 1-321235-0 1-321235-1	300 V Max.
321235 321688	300 V Max.	321235 321688	300 V Max.

Table of Contents

Terminals

Receptacles 34-35

Receptacles (Insulation Restricting) 35

Splices

Line Splice Connector for "250" Series and "187" Series..... 36

Dimensions are shown for reference purposes only.

Dimensions are in inches and millimeters unless otherwise specified. Values in brackets are metric equivalents.

Specifications subject to change.

Technical Support Center
1-800-522-6752
www.amp.com



PIDG FASTON (Continued)

Receptacles

Receptacle Style:

- A** — No dimple with wire stop
- B** — Dimple with wire stop
- C** — No dimple, no wire stop

Material

- Insulation** — Nylon, UL 94V-2
- Receptacle Body** — Brass per ASTM B-36 or Phosphor Bronze per ASTM B-139
- Plating** — Tin per ASTM B-545 except where noted.
- Metallic Sleeve** — Copper per ASTM B-152
- Plating** — Tin per ASTM B-545

Related Product Data

- Insulation Color Code** — pg. 4
- Packaging Quantities** — pg. 4
- Performance Specifications** — pgs. 4 & 5
- Application Tooling** — pg. 73

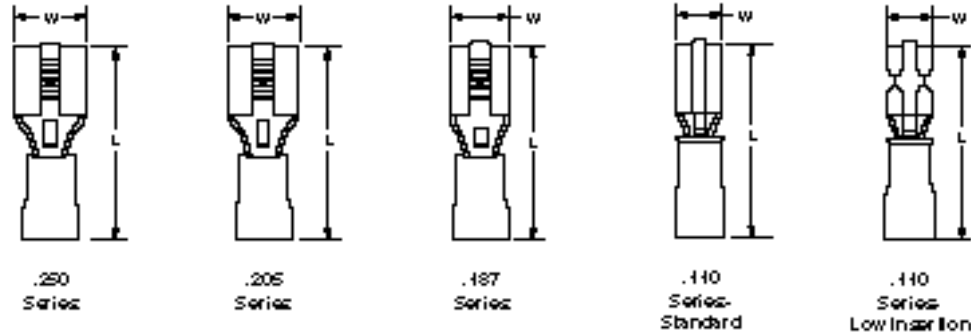

Series	Wire Size Circular Mils [mm ²]	Style	Dimensions		Terminal Insulation Color	Wire Insulation Diameter Max.	Recept. Matl.	Stock Thk.	Fits Tab Thk.	Part Numbers		
			W Nom.	L Max.						Loose Piece	Tape Mounted	Strip Form
.250	22-18 509-1,900 [0.26-0.96]	B	.300	.900	Red	.140	Brass	.018	.032	640903-1*	640903-2	640902-1
			7.62	22.86	Red	3.56	Brass	0.46	0.81	55675-1 ²	55675-2 ²	—
	16-14 2,050-5,180 [1.04-2.62]	B	.300	.900	Blue	.170	Brass	.018	.032	640905-1*	640905-2	640904-1
			7.62	22.86	Blue	4.32	Brass	0.46	0.81	—	—	—
	14-12 3,831-6,470 ¹ [1.94-3.28]	B	.300	1.012	Green	.250	Brass	.018	.032	42844-1**†	42844-3†	60544-3†
			7.62	25.70	Green	6.35	Phos. Brz.	0.46	0.81	42844-2**†	—	—
	12-10 5,180-13,100 [2.62-6.64]	B	.300	1.012	Yellow	.250	Brass	.018	.032	640907-1*	640907-2	640906-1
			7.62	25.70	Yellow	6.35	Phos. Brz.	0.46	0.81	61198-2	61198-4	—
.250 Low Insertion	22-18 509-1,900 [0.26-0.96]	B	.300	.900	Red	.145	Brass	.016	.032	184262-1	184262-2	184261-1
			7.62	22.86	Red	3.68	Brass	.406	.813	—	—	—
16-14 2,050-5,180 [1.04-2.62]	B	.300	.900	Blue	.173	Brass	.016	.032	184265-1	184265-2	184264-1	
		7.62	22.86	Blue	4.39	Brass	.406	.813	—	—	—	
.205	22-18 509-1,900 [0.26-0.96]	B	.250	.800	Red	.135	Brass	.016	.020	696018-1	696018-2	—
			6.35	20.32	Red	3.43	Brass	0.41	0.51	640909-1*	640909-2	640908-1
			.250	.800	Red/Black	.140	Brass	.016	.020	640174-1	—	—
	16-14 2,050-5,180 [1.04-2.62]	B	.250	.800	Red	.140	Brass	.016	.032	640911-1*	640911-2	640910-1
			6.35	20.32	Red	3.56	Brass	0.41	0.81	—	—	—
			.250	.800	Blue	.170	Brass	.016	.020	640913-1*	640913-2	—
.187	26-24 238-475 [0.12-0.24]	B	.230	.700	Yellow	.082	Brass	.016	.020	641321-1**†	641321-2†	641320-1†
			5.84	17.78	Yellow	2.08	Brass	0.41	0.51	—	—	—
			.230	.800	Red	.140	Brass	.016	.020	640917-1*	640917-2	640916-1
22-18 509-1,900 [0.26-0.96]	B	.230	.800	Red	.140	Brass	.016	.040	—	640578-2†	—	
		5.84	20.32	Red	3.56	Brass	0.41	1.02	—	—	—	

[†]Not UL or CSA approved or listed.
^{*}Available in small packaging quantities.

¹Wire range is limited as noted.
²Unplated receptacle body.

**PIDG FASTON** (Continued)

PIDG FASTON

Receptacles (Continued)

Series	Wire Size Circular Mils [mm ²]	Style	Dimensions		Terminal Insulation Color	Wire Insulation Diameter Max.	Recept. Matl.	Stock Thk.	Fits Tab Thk.	Part Numbers									
			W Nom.	L Max.						Loose Piece	Tape Mounted	Strip Form							
.187	16-14 2,050-5,180 [1.04-2.62]	B	.230	.800	Blue	.170	Brass	.016	.020	640919-1*	640919-2	640918-1							
			5.84	20.32	Blue	4.32							0.51						
.187 Low Insertion	22-18 509-1,900 [0.26-0.96]	B	.230	.900	Blue	.250	Brass	.016	.020	696108-1	696108-2	—							
			5.84	22.86	Blue	6.35							0.51						
.110 Standard	22-18 509-1,900 [0.26-0.96]	B	.230	.800	Red	.145	Brass	.016	.032	184268-1	184268-2	184267-1							
			5.84	22.86	Red	3.68							.813						
			.148	.734	Natural	.110							.012	.020	61048-1**	61048-2†	—		
			3.76	18.64	Natural	2.79												0.30	0.51
			.148	.734	Natural	.110												.012	.032
3.76	18.64	Natural	2.79	0.30	0.81														
.148	.734	Black	.110	.012	.032	60894-1**	60894-2†	60893-2†											
3.76	18.64	Black	2.79						0.30	0.81	—	61678-2†	—						
.110 Low Insertion	26-24 238-475 [0.12-0.24]	A	.160	.700	Yellow	.082	Brass	.016	.020	641324-1†	641324-2†	—							
			4.06	17.78	Yellow	2.08							0.51						
	22-18 509-1,900 [0.26-0.96]	A	.160	.796	Red	.140	Brass	.016	.012	—	—	350871-1†							
			4.06	20.22	Red	3.56							0.30						
			.160	.800	Red	.140							.016	.016	640921-1	640921-2	—		
			4.06	20.32	Red	3.56												0.41	0.41
	.160	.800	Red	.140	.016	.020	640923-1*	640923-2	640922-1										
	4.06	20.32	Red	3.56						0.41	0.51								
	.160	.800	Red	.140	.016	.032	640925-1*	640925-2	640924-1										
	4.06	20.32	Red	3.56						0.41	0.81								
16-14 2,050-5,180 [1.04-2.62]	A	.160	.800	Blue	.170	Brass	.016	.020	640929-1*	640929-2	—								
		4.06	20.32	Blue	4.32							0.51							
		.160	.800	Blue	.170							.016	.032	640931-1*	640931-2	—			
		4.06	20.32	Blue	4.32												0.41	0.81	
		.160	.800	Blue	.170							.016	.016	640927-1	640927-2	—			
		4.06	20.32	Blue	4.32												0.41	0.41	
.160	.796	Blue	.170	.016	.032	641317-1	—	—											
4.06	20.19	Blue	4.32						0.41	0.81									

†Not UL or CSA approved or listed.

*Available in small packaging quantities.

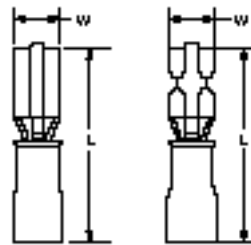
Receptacles
(Insulation Restricting).110
Series—
Standard.110
Series
Low Insertion**Material****Insulation**—Nylon, UL 94V-2**Receptacle Body**—Brass per ASTM B-36**Receptacle Style B**—Dimple with wire stop**Plating**—Tin per ASTM B-545**Metallic Sleeve**—Copper per ASTM B-152**Plating**—Tin per ASTM B-545 or Nickel per QQ-N-290**Related Product Data****Insulation Color Code**—pg. 4**Packaging Quantities**—pg. 4**Performance Specifications**—pgs. 4 & 5**Application Tooling**—pg. 73

Series	Wire Size Circular Mils [mm ²]	Style	Dimensions		Terminal Insulation Color Solid/Stripe	Wire Insulation Diameter Range	Recept. Matl.	Stock Thk.	Fits Tab Thk.	Part Numbers		
			W Nom.	L Max.						Loose Piece	Tape Mounted	Strip Form
.110 Standard	22 754 [0.38]	B	.148	.780	Red/ Green	.040-.080 1.02-2.03	Brass	.012	.016	55319-1	55319-3	—
			3.76	19.81				0.30	0.41			

Dimensions are shown for reference purposes only.

Dimensions are in inches and millimeters unless otherwise specified. Values in brackets are metric equivalents.

Specifications subject to change.

Technical Support Center
1-800-522-6752
www.amp.com



PIDG FASTON (Continued)

Line Splice Connector for "250" Series Terminals



Material

Insulation — Vinyl, UL 94V-0
Color — Natural
Splice Body — Brass per ASTM B-36
Plating — Tin per ASTM B-545 except where noted.

Related Product Data

Insulation Color Code — pg. 4
Packaging Quantities — pg. 4
Performance Specifications — pgs. 4 & 5

Wire Size	Plating	Dimensions			Part Numbers Loose Piece
		W	L Max.	E Min.	
22-10	Unplated	.391 9.93	2.093 53.16	.860 21.84	321235*
	Tin	.391 9.93	2.093 53.16	.860 21.84	321688
	Unplated	.409 10.39	2.625 66.68	1.151 29.24	1-321235-0
	Tin	.409 10.39	2.625 66.68	1.151 29.24	1-321235-1
	Unplated	.409 10.39	2.451 62.26	.970 ² 24.64	1-321235-3 ¹

*Available in small packaging quantities.
¹Oval expansion at end opposite "w". (.380 x .320 inside diameter.)
²E min. on expansion end only.

Line Splice Connector for "187" Series Terminals

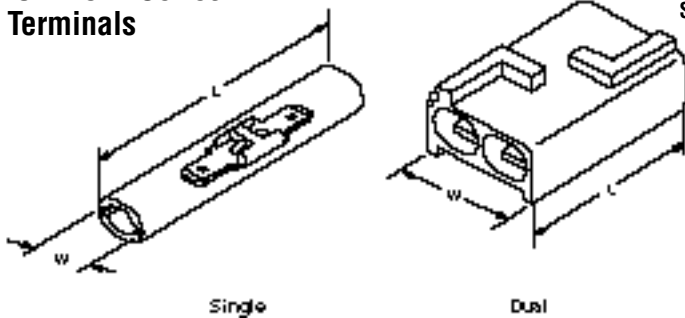

Material

Housing — Nylon, UL 94V-2
Splice Body — Brass per ASTM B-36

Related Product Data

Insulation Color Code — pg. 4
Packaging Quantities — pg. 4
Performance Specifications — pgs. 4 & 5

Type	Housing Color	Dimensions		Temperature Rating	Part Numbers Loose Piece
		W	L		
Single	Natural	.345 8.76	1.750 44.45	—	360035-1 [†]
Dual	Natural	.650 16.51	1.750 44.45	105°C	360025-1 [†]
Dual	Black	.650 16.51	1.750 44.45	150°C	360025-2 [†]

[†]ULFile E66717
600 V Max

Receptacle (Low Insertion Force)

Series	Wire Size Circular Mils [mm ²]	Dimensions		Terminal Insulation Color	Wire Insulation Diameter Max.	Recept. Matl.	Stock Thk.	Fits Tab Thk.	Part Numbers		
		W Nom.	L Max.						Loose Piece	Tape Mounted	Strip Form
.250 Low Insertion	22-18 509-1,900 [0.26-0.96]	.300 7.62	.900 22.86	Red	.145 3.68	Brass	.016 .406	.032 .813	184262-1	184262-2	184261-1
.250 Low Insertion	16-14 2,050-5,180 [1.04-2.62]	.300 7.62	.900 22.86	Blue	.173 4.39	Brass	.016 .406	.032 .813	184265-1	184265-2	184264-1
.187 Low Insertion	22-18 509-1,900 [0.26-0.96]	.230 5.84	.800 22.86	Red	.145 3.68	Brass	.016 .406	.032 .813	184268-1	184268-2	184267-1
.187 Low Insertion	16-14 2,050-5,180 [1.04-2.62]	.300 7.62	.900 22.86	Blue	.173 4.39	Brass	.016 .406	.032 .813	184235-1	184235-2	184234-1