



PLASTI-GRIP

Product Facts

- Pre-insulated PLASTI-GRIP solderless terminals and splices
- Designed specifically to answer the need for inexpensive, insulated electrical terminations
- Can be used in almost every type of commercial application
- Accommodate wire sizes from 22 AWG through 2/0 AWG

The Crimp

- Carefully engineered application tooling has been developed to ensure uniformly high quality terminations
- Tool and terminal have been designed as a team to promote ease and speed of application and at the same time to provide precise crimping pressure for every wire size
- The wire and the terminal barrel form a homogeneous mass of metal, providing a connection of maximum conductivity, tensile strength, and high resistance to corrosion
- The quality performance, the facility of installation and the inherent simplicity make them ideal for many industrial applications

Color Coding. Terminal insulation is color-coded by wire size range to eliminate errors during installation.

Basic Terminal Material. The basic terminal is constructed of fine grade high conductivity copper per ASTM B-152 and tin-plated per ASTM B-545. Basic material for Spring Spade Tongue Terminals is phosphor bronze per ASTM B-139 or brass per ASTM B-36 and tin-plated per ASTM B-545. AMP's special plating process creates durable corrosion resistance to salt spray and most chemical fumes.

Insulation. Vinyl insulation sleeve provides good dielectric strength and supports the wire insulation so that no bare wire is exposed.

Serrations. Serrations inside barrel provide maximum contact and tensile strength after crimping. Dimples on 8 to 2/0 range.

Funnel Entry. Assures rapid wire insertion during high speed production. (Except 8 to 2/0 range.)

Temperature Rating: 90°C Max.

AMP PLASTI-GRIP Terminals and Splices (Use PLASTI-GRIP or PIDG Tooling)

AMP Wire Range	UL Listed	LR 7189 Certified	8 thru 4/0 600V
Except as noted with individual part number listing.			
22-16	Terminals, Butt & Parallel Splices 22-16 Solid or Stranded ¹	600 V Max. (1000 V Fixture or Sign) 90°C Max.	Recognized under the component program of Underwriters Laboratories Incorporated File No. E13288
16-14	Terminals, Butt & Parallel Splices 16-14 Solid or Stranded ¹		
12-10	Terminals, Butt & Parallel Splices 12-10 Solid or Stranded ¹		

Note: 22-16 terminals and splices are stamped 22-18 in accordance with MIL-T-7928.
¹Stranded wire only using TETRA-CRIMP tooling.

PLASTI-GRIP

Table of Contents

Terminals

- Ring Tongue 38-42
- Ring Tongue 90° Bend and Rectangular Tongue 43
- Spade Tongue 44
- Flanged Spade Tongue 45
- Short Spring Spade Tongue and Long Spring Spade Tongue 46, 47
- Slotted Ring Tongue and Hook Tongue 48
- Flag Tongue and Multiple Stud 49

Splices

- Butt 50
- Parallel and Shur-Plug (.093, .156 and .180 Series) 51
- 3-Way Connector and .250 Tube Cap Assembly 52



PLASTI-GRIP (Continued)

Ring Tongue Terminals

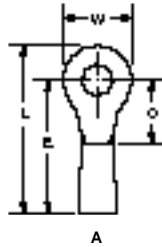

Material

Insulation — Vinyl, UL 94V-0
Terminal Body — Copper per ASTM B-152
Plating — Tin per ASTM B-545

Related Product Data

Insulation Color Code — pg. 4
Packaging Quantities — pg. 4
Performance Specifications — pgs. 4 & 5
Application Tooling — pg. 72

Wire Size Circular Mills [mm ²]	Tongue Material Thickness Max.	Stud Size	Style	Dimensions				Terminal Insulation Color	Wire Insulation Diameter Max.	Part Numbers	
				W	C Min.	E Max.	L Max.			Loose Piece	Tape Mounted
22-16 509-3,260 [0.26-1.65]	.033 0.84	2 M2	A	.218	.156	.572	.684	Red	.140	34140*	2-34140-1
				5.54	3.96	14.53	17.37				
		4	A	.218	.156	.572	.684	Red	.125	32944*	2-32944-1
				5.54	3.96	14.53	17.37				
				.218	.156	.572	.684	Red	.140	34141*	2-34141-1
				5.54	3.96	14.53	17.37				
				.281	.250	.666	.809	Red	.140	34143	2-34143-1
				7.14	6.35	16.92	20.55				
		6 M3.5	A	.218	.156	.572	.684	Red	.125	32945*	2-32945-1
				5.54	3.96	14.53	17.37				
				.218	.156	.572	.684	Red	.140	34142*	1-34142-1
				5.54	3.96	14.53	17.37				
				.281	.250	.666	.809	Red	.125	32947*	2-32947-1
				7.14	6.35	16.92	20.55				
		8 M4	A	.281	.250	.666	.809	Red	.140	34144*	2-34144-1
				7.14	6.35	16.92	20.55				
				.281	.250	.666	.809	Black	.140	326819	2-326819-1
				7.14	6.35	16.92	20.55				
				.281	.250	.666	.809	Red	.170	—	2-35449-1
				7.14	6.35	16.92	20.55				
		10	A	.312	.281	.697	.856	Red	.125	32950	2-32950-1
				7.92	7.14	17.70	21.74				
				.312	.281	.697	.856	Red	.140	34147*	2-34147-1
				7.92	7.14	17.70	21.74				
.281	.250			.666	.809	Red	.125	32948*	2-32948-1		
7.14	6.35			16.92	20.55						
.281	.250			.666	.809	Red	.140	34145*	2-34145-1		
7.14	6.35			16.92	20.55						
1/4 M6	A			.312	.281	.697	.856	Red	.125	32951*	2-32951-1
				7.92	7.14	17.70	21.74				
				.312	.281	.697	.856	Red	.140	34148*	2-34148-1
				7.92	7.14	17.70	21.74				
		.312	.281	.746	.905	Red	.200	—	2-34148-4		
		7.92	7.14	18.95	22.99						
1/4 M6	A	.281	.250	.666	.809	Red	.125	32949*	2-32949-1		
		7.14	6.35	16.92	20.55						
		.281	.250	.666	.809	Red	.140	34146*	2-34146-1		
		7.14	6.35	16.92	20.55						
		.281	.250	.666	.809	Black	.140	2-34146-4	2-34146-5		
		7.14	6.35	16.92	20.55						
1/4 M6	A	.281	.250	.666	.809	Red	.170	35451	2-35451-1		
		7.14	6.35	16.92	20.55						
		.312	.281	.697	.856	Red	.125	32952*	2-32952-1		
		7.92	7.14	17.70	21.74						
		.312	.281	.697	.856	Red	.140	34149*	2-34149-1		
		7.92	7.14	17.70	21.74						
1/4 M6	A	.312	.281	.746	.905	Red	.200	—	2-34149-3		
		7.92	7.14	18.95	22.99						
		.469	.437	.853	1.090	Red	.125	32953*	2-32953-1		
11.91	11.10	21.67	27.69								
1/4 M6	A	.469	.437	.853	1.090	Red	.140	34150*	2-34150-1		
		11.91	11.10	21.67	27.69						
		.469	.437	.853	1.090	Black	.140	—	2-34150-3		

*Available in small packaging quantities.
Note: "C" dimension applies from edge of metal wire barrel to center of stud hole. (Styles A & E).



PLASTI-GRIP (Continued)

Ring Tongue Terminals

(Continued)

Wire Size Circular Mils [mm ²]	Tongue Material Thickness Max.	Stud Size	Style	Dimensions				Terminal Insulation Color	Wire Insulation Diameter Max.	Part Numbers	
				W	C Min.	E Max.	L Max.			Loose Piece	Tape Mounted
22-16 509-3,260 [0.26-1.65]	.033 0.84	5/16 M8	A	.469	.437	.853	1.090	Red	.140	34151*	2-34151-1
				11.91	11.10	21.67	27.69	Black	.140	—	2-34151-3
		3/8	A	.531	.546	.962	1.230	Red	.140	34152*	2-34152-2
				13.49	13.87	24.43	31.24	Black	.140	—	2-34152-4
		4	A	.250	.171	.587	.715	Blue	.170	34157*	2-34157-1
				6.35	4.34	14.91	18.16	Blue	.145	32957*	2-32957-1
6 M3.5	.033 0.84	A	.250	.171	.587	.715	Blue	.170	34158*	2-34158-1	
			6.35	4.34	14.91	18.16	Blue	3.68	32958*	2-32958-1	
		A	.343	.281	.697	.871	Blue	.145	34159*	2-34159-1	
			8.71	7.14	17.70	22.12	Blue	3.68	—	—	
		A	.312	.250	.666	.825	Blue	.170	328527*	2-328527-1	
			7.92	6.35	16.92	20.96	Blue	4.32	—	—	
8 M4	.033 0.84	A	.343	.281	.697	.871	Blue	.145	32959*	2-32959-1	
			8.71	7.14	17.70	22.12	Blue	3.68	34160*	2-34160-1	
		A	.343	.281	.697	.871	Blue	.170	34160*	2-34160-1	
			8.71	7.14	17.70	22.12	Blue	4.32	2-34160-2	2-34160-3	
		A	.343	.281	.746	.920	Blue	.250	32960*	2-32960-1	
			8.71	7.14	18.95	23.37	Blue	6.35	34161*	2-34161-1	
10	.033 0.84	A	.343	.281	.697	.871	Blue	.145	32960*	2-32960-1	
			8.71	7.14	17.70	22.12	Blue	.170	34161*	2-34161-1	
		A	.343	.281	.746	.920	Blue	.250	2-34161-2	2-34161-3	
			8.71	7.14	18.95	23.37	Blue	6.35	—	—	
		A	.343	.281	.746	.920	Black	.250	—	2-34959-1	
			8.71	7.14	18.95	23.37	Black	6.35	—	—	
A	.468	.312	.728	.965	Blue	.170	—	2-34954-1			
	11.89	7.92	18.49	24.51	Blue	4.32	—	—			
1/4 M6	.033 0.84	A	.469	.437	.853	1.090	Blue	.145	32961*	2-32961-1	
			11.91	11.10	21.67	27.69	Blue	3.68	34162*	2-34162-1	
		A	.469	.437	.853	1.090	Black	.170	2-34162-2	2-34162-3	
			11.91	11.10	21.67	27.69	Black	4.32	—	—	
		A	.469	.437	.853	1.090	Blue	.170	34163*	2-34163-1	
			11.91	11.10	21.67	27.69	Blue	4.32	—	—	
A	.531	.546	.962	1.248	Blue	.170	34164*	2-34164-2			
	13.49	13.87	24.43	31.70	Blue	4.32	—	—			
6 M3.5	.050 1.27	A	.281	.219	.810	.953	Yellow/Blk.	.200	34821	2-34821-1	
			7.14	5.56	20.57	24.21	Yellow/Blk.	5.08	—	—	
		A	.343	.281	.872	1.046	Yellow/Blk.	.200	34822†	—	
			8.71	7.14	22.15	26.57	Yellow/Blk.	5.08	34823*†	2-34823-1†	
		A	.343	.281	.872	1.046	Yellow/Blk.	.200	34823*†	2-34823-1†	
			8.71	7.14	22.15	26.57	Yellow/Blk.	5.08	321518	2-321518-1	
A	.343	.281	.872	1.046	Yellow/Blk.	.250	321518	2-321518-1			
	8.71	7.14	22.15	26.57	Yellow/Blk.	6.35	—	—			

† Not UL or CSA Approved or Listed.

*Available in small packaging quantities.

† Heavy Duty for extra mechanical strength.

Note: "C" dimension applies from edge of metal wire barrel to center of stud hole. (Styles A & E).



PLASTI-GRIP (Continued)

Ring Tongue Terminals

(Continued)

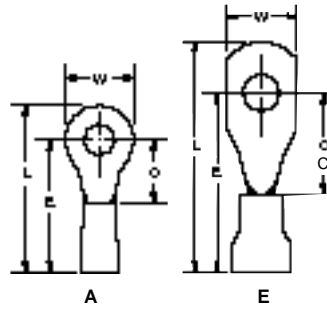

Material

Insulation — Vinyl, UL 94V-0
Terminal Body — Copper per ASTM B-152
Plating — Tin per ASTM B-545

Related Product Data

Insulation Color Code — pg. 4
Packaging Quantities — pg. 4
Performance Specifications — pgs. 4 & 5
Application Tooling — pgs. 72 & 73

Wire Size Circular Mils [mm ²]	Tongue Material Thickness Max.	Stud Size	Style	Dimensions				Terminal Insulation Color	Wire Insulation Diameter Max.	Part Numbers	
				W	C Min.	E Max.	L Max.			Loose Piece	Tape Mounted
16-14HD ¹ 2,050-5,180 [1.04-2.62]	.050 1.27	1/4 M6	A	.500 12.70	.344 8.74	.935 23.75	1.188 30.18	Yellow/Blk.	.230 5.84	35349	2-35349-1
				.531 13.49	.437 11.10	1.028 26.11	1.296 32.92	Yellow/Blk.	.200 5.08	34824	2-34824-3
		5/16 M8	A	.531 13.49	.437 11.10	1.028 26.11	1.296 32.92	Yellow/Blk.	.200 5.08	34825	—
				.750 19.05	.625 15.88	1.216 30.89	1.594 40.49	Yellow/Blk.	.200 5.08	34826	—
		1/2 M12	A	.750 19.05	.625 15.88	1.216 30.89	1.594 40.49	Yellow/Blk.	.200 5.08	34827	—
12-10 5,180-13,100 [2.62-6.64]	.042 1.07	0	A	.281 7.14	.219 5.56	.810 20.57	.953 24.21	Yellow	.250 6.35	2-34835-4	—
		4	A	.281 7.14	.219 5.56	.810 20.57	.953 24.21	Yellow	.250 6.35	34835	2-34835-1
		6 M3.5	A	.281 7.14	.219 5.56	.810 20.57	.953 24.21	Yellow	.250 6.35	34852*	2-34852-1
				.375 9.53	.302 7.67	.893 22.68	1.098 27.89	Yellow	.230 5.84	34168*	2-34168-1
		8 M4	A	.312 7.92	.302 7.67	.893 22.68	1.062 26.97	Yellow	.250 6.35	—	696047-1
				.312 7.92	.302 7.67	.893 22.68	1.062 26.97	Yellow	.250 6.35	—	696048-1
				.375 9.53	.302 7.67	.893 22.68	1.098 27.89	Yellow	.230 5.84	34169*	2-34169-1
				.375 9.53	.302 7.67	.893 22.68	1.098 27.89	Yellow	.250 6.35	34853*	2-34853-1
		10	A	.312 7.92	.302 7.67	.893 22.68	1.052 26.72	Yellow	.230 5.84	330518	—
				.312 7.92	.302 7.67	.953 24.21	1.111 28.22	Yellow	.300 ¹²⁻¹⁰ 7.62	—	1-330518-2
				.375 9.53	.302 7.67	.893 22.68	1.083 27.51	Black	.250 6.35	—	2-328261-1
				.375 9.53	.302 7.67	.893 22.68	1.098 27.89	Yellow	.230 5.84	34170*	2-34170-1
				.375 9.53	.302 7.67	.893 22.68	1.098 27.89	Yellow	.250 6.35	34854*	2-34854-1
		1/4 M6	E	.400 10.16	.468 11.89	1.118 28.40	1.373 34.87	Yellow	.300 7.62	55678-1	55678-2
			A	.500 12.70	.344 8.74	.994 25.25	1.247 31.67	Black	.300 7.62	35492	—
.531 13.49	.468 11.89	1.059 26.90		1.327 33.71	Yellow	.230 5.84	34171*	2-34171-1			
.531 13.49	.468 11.89	1.059 26.90		1.327 33.71	Yellow	.250 6.35	34855*	2-34855-1			
5/16 M8	A	.531 13.49	.468 11.89	1.059 26.90	1.327 33.71	Yellow	.230 5.84	34172*	2-34172-1		
		.531 13.49	.468 11.89	1.059 26.90	1.327 33.71	Black	.230 5.84	—	2-34172-3		
		.531 13.49	.468 11.89	1.059 26.90	1.327 33.71	Yellow	.250 6.35	34856*	2-34856-1		
3/8	A	.593 15.06	.531 13.49	1.122 28.50	1.421 36.09	Yellow	.230 5.84	34173*	2-34173-1		
1/2 M12	A	.750 19.05	.625 15.88	1.216 30.89	1.594 40.49	Yellow	.250 6.35	34837*	2-34837-4		

*Available in small packaging quantities.

¹Heavy Duty for extra mechanical strength.

Note: "C" dimension applies from edge of metal wire barrel to center of stud hole. (Styles A & E).



PLASTI-GRIP (Continued)

Ring Tongue Terminals

(Continued)

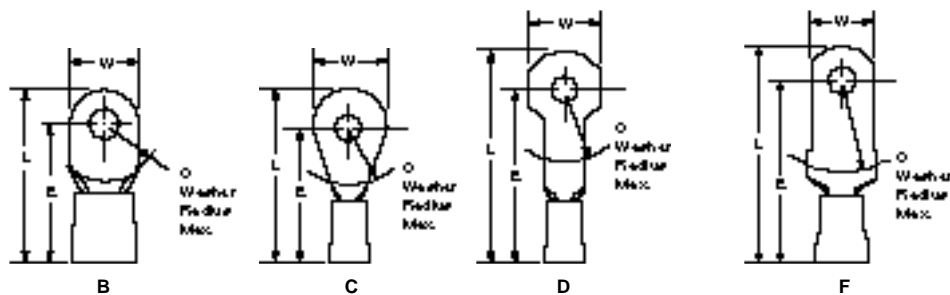

Wire Size Circular Mils [mm ²]	Tongue Material Thickness Max.	Stud Size	Style	Dimensions				Terminal Insulation Color	Wire Insulation Diameter Max.	Part Numbers	
				W	C	E Max.	L Max.			Loose Piece	Tape Mounted
8 13,100-20,800 [6.64-10.5]	.043 1.09	8 M4	C	.478	.437	1.344	1.586	Red	.360	52041	52041-6
				12.14	11.10	34.14	40.28				
		10	D	.430	.437	1.363	1.605	Red	.360	—	54351-2
				10.92	11.10	34.62	40.77				
			B	.431	.437	1.338	1.556	Red	.360	52263	52263-2
				10.95	11.10	33.99	39.52				
				.431	.437	1.338	1.556				
				10.95	11.10	33.99	39.52				
		1/4 M6	C	.431	.437	1.358	1.576	Red	.330	52263-1	52263-3
				10.95	11.10	34.49	40.03				
		5/16 M8	C	.431	.437	1.303	1.561	Red	.360	55621-1	55621-2
				10.95	11.10	33.10	39.65				
3/8	C	.478	.437	1.344	1.586	Red	.360	52041-1	52041-7		
		12.14	11.10	34.14	40.28						
1/2 M12	A	.478	.437	1.358	1.600	Red	.330	52041-3*	52041-9		
		12.14	11.10	34.49	40.64						
6 20,800-33,100 [10.5-16.8]	.048 1.22	5/16 M8	C	.587	.500	1.400	1.696	Red	.360	52291*	52291-4
				14.91	12.70	35.56	43.08				
		3/8	C	.587	.500	1.400	1.696	Red	.360	52291-1*	52291-5
				14.91	12.70	35.56	43.08				
		8 M4	C	.875	.625	1.420	1.860	Red	.330	52262-1	—
				22.23	15.88	36.07	47.24				
		10	B	.500	.515	1.591	1.844	Blue	.436	52042	—
				12.70	13.08	40.41	46.84				
			C	.500	.515	1.591	1.869	Blue	.360	52042-2	—
				12.70	13.08	40.41	47.47				
				.468	.421	1.482	1.719				
				11.89	10.69	37.64	43.66				
1/4 M6	C	.468	.421	1.482	1.719	Blue	.436	52265*	52265-3		
		11.89	10.69	37.64	43.66						
5/16 M8	B	.500	.515	1.591	1.844	Blue	.436	52042-4	—		
		12.70	13.08	40.41	46.84						
3/8	B	.500	.515	1.591	1.869	Blue	.360	52042-5*	—		
		12.70	13.08	40.41	47.47						
1/2 M12	C	.398	.515	1.591	1.846	Blue	.450	55679-1	55679-2		
		10.11	13.08	40.41	46.89						
5/16 M8	B	.500	.515	1.591	1.844	Blue	.436	52042-1	52042-7		
		12.70	13.08	40.41	46.84						
3/8	B	.500	.515	1.591	1.869	Blue	.360	52042-3*	52042-9		
		12.70	13.08	40.41	47.47						
1/2 M12	C	.625	.515	1.591	1.906	Blue	.450	52264*	52264-4		
		15.88	13.08	40.41	48.41						
3/8	B	.625	.515	1.591	1.906	Blue	.450	52264-1*	52264-5		
		15.88	13.08	40.41	48.41						
1/2 M12	C	.815	.515	1.441	1.851	Blue	.436	52350*	—		
		20.70	13.08	36.60	47.02						

*Available in small packaging quantities.

Note: "C" dimension applies from edge of metal wire barrel to center of stud hole. (Styles A & E).



PLASTI-GRIP (Continued)

Ring Tongue Terminals

(Continued)

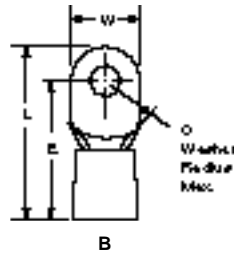

Material

Insulation — Vinyl, UL 94V-0
Terminal Body — Copper per ASTM B-152
Plating — Tin per ASTM B-545

Related Product Data

Insulation Color Code — pg. 4
Packaging Quantities — pg. 4
Performance Specifications — pgs. 4 & 5
Application Tooling — pg. 73

Wire Size Circular Mils [mm ²]	Tongue Material Thickness Max.	Stud Size	Style	Dimensions				Terminal Insulation Color	Wire Insulation Diameter Max.	Part Numbers				
				W	C	E Max.	L Max.			Loose Piece	Tape Mounted			
4 33,100-52,600 [16.8-26.7]	.051 1.30	10	B	.546	.531	1.672	1.948	Yellow	.450	52043-2	—			
				13.87	13.49	42.47	49.48	Yellow	11.43	—	—			
			1/4 M6	B	.546	.531	1.672	1.948	Yellow	.450	52043	52043-4		
					13.87	13.49	42.47	49.48	Yellow	11.43	—	55680-2		
			5/16 M8	B	.546	.531	1.672	1.948	Yellow	.450	52043-3*	52043-7		
					13.87	13.49	42.47	49.48	Yellow	11.43	52043-1	52043-5		
		3/8	B	.679	.531	1.672	2.014	Yellow	.450	52266-3	52266-9			
				17.25	13.49	42.47	51.16	Yellow	11.43	52266	—			
		2 52,600-83,700 [26.7-42.4]	.060 1.52	1/4 M6	B	.675	.578	1.731	2.071	Red	.560	52266-4*	1-52266-0	
						17.15	14.68	43.97	52.60	Red	14.22	52266-1	—	
					5/16 M8	B	.675	.578	1.731	2.071	Red	.560	52267	—
							17.15	14.68	43.97	52.60	Red	16.05	52044-4	—
3/8	B				.711	.578	1.731	2.089	Red	.560	52044-1	—		
					18.06	14.68	43.97	53.06	Red	16.05	52044-5	—		
1/2 M12	B			.711	.578	1.731	2.089	Red	.560	52044-2	—			
				18.06	14.68	43.97	53.06	Red	16.05	52045-1	—			
1/0 83,700-119,500 [42.4-60.6]	.073 1.85			5/16 M8	B	.807	.625	2.041	2.447	Blue	.684	52045-5	—	
						20.50	15.88	51.84	62.15	Blue	17.37	52045-2	—	
				3/8	B	.807	.625	2.041	2.447	Blue	.665	52289	—	
						20.50	15.88	51.84	62.15	Blue	16.89	52046-1	—	
		1/2 M12	B	.807	.625	2.041	2.447	Blue	.684	—	—			
				20.50	15.88	51.84	62.15	Blue	17.37	—	—			
2/0 119,500-150,500 [60.6-76.3]	.083 2.11	5/16 M8	B	.926	.625	2.082	2.477	Yellow	.775	—				
				23.52	15.88	52.88	62.92	Yellow	19.69	—				

*Available in small packaging quantities.

PLASTI-GRIP



PLASTI-GRIP (Continued)

**Ring Tongue
90° Bend Terminals**

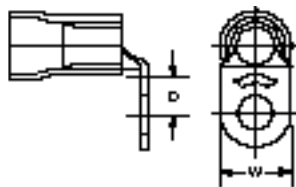

Material

Insulation — Vinyl, UL 94V-0
Terminal Body — Copper per ASTM B-152
Plating — Tin per ASTM B-545

Related Product Data

Insulation Color Code — pg. 4
Packaging Quantities — pg. 4
Performance Specifications — pgs. 4 & 5
Application Tooling — pg. 73

Wire Size Circular Mils [mm ²]	Tongue Material Thickness Max.	Stud Size	Dimensions		Terminal Insulation Color	Wire Insulation Diameter Max.	Part Numbers	
			W	D Min.			Loose Piece	
8 13,100-20,800 [6.64-10.5]	.043 1.09	10	.431 10.95	.311 7.90	Red	.360 9.14	55654-1	
		1/4 M6	.478 12.14	.435 11.05	Red	.360 9.14	54725-1	
6 20,800-33,100 [10.5-16.8]	.048 1.22	10	.500 12.70	.310 7.87	Blue	.436 11.07	54753-1	
		1/4 M6	.500 12.70	.379 9.63	Blue	.436 11.07	54754-1	

PLASTI-GRIP

**Rectangular
Tongue Terminals**

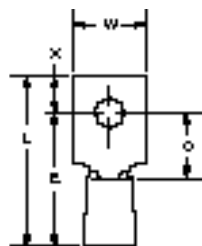

Material

Insulation — Vinyl, UL 94V-0
Terminal Body — Copper per ASTM B-152
Plating — Tin per ASTM B-545

Related Product Data

Insulation Color Code — pg. 4
Packaging Quantities — pg. 4
Performance Specifications — pgs. 4 & 5
Application Tooling — pg. 72

Wire Size Circular Mils [mm ²]	Tongue Material Thickness Max.	Stud Size	Dimensions					Terminal Insulation Color	Wire Insulation Diameter Max.	Part Numbers	
			W	C Min.	E Max.	L Max.	X			Loose Piece	Tape Mounted
16-14 2,050-5,180 [1.04-2.62]	.033 0.84	6 M3.5	.249 6.32	.312 7.92	.728 18.49	.868 22.05	.125 3.18	Blue	.145 3.68	34898	—

Note: "C" dimension applies from edge of metal wire barrel to center of stud hole.



PLASTI-GRIP (Continued)

Spade Tongue Terminals

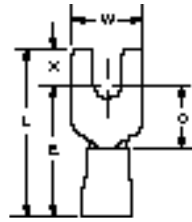

Material

Insulation — Vinyl, UL 94V-0
Terminal Body — Copper per ASTM B-152
Plating — Tin per ASTM B-545

Related Product Data

Insulation Color Code — pg. 4
Packaging Quantities — pg. 4
Performance Specifications — pgs. 4 & 5
Application Tooling — pg. 72

PLASTI-GRIP

Wire Size Circular Mils [mm ²]	Tongue Material Thickness Max.	Stud Size	Dimensions					Terminal Insulation Color	Wire Insulation Diameter Max.	Part Numbers	
			W	C Min.	E Max.	L Max.	X			Loose Piece	Tape Mounted
22-16 509-3,260 [0.26-1.65]	.033 0.84	6 M3.5	.250	.312	.728	.858	.125	Red	.140	327043*	2-327043-1
			6.35	7.92	18.49	21.79	3.18		.125		
			.297	.203	.619	.765	.141	Red	.125	327735*	2-327735-1
			7.54	5.16	15.72	19.43	3.58		.125		
			.297	.203	.619	.765	.141	Red	.140	320665*	2-320665-1
			7.54	5.16	15.72	19.43	3.58		.140		
		.307	.245	.661	.836	.175	Red	.140	696003-1	696003-2	
		7.80	6.22	16.79	21.23	4.45		.120			
		.375	.312	.728	.920	.187	Red	.120	32981	2-32981-1	
		9.53	7.92	18.49	23.37	4.75		.140			
		.375	.312	.728	.920	.187	Red	.140	34155*	2-34155-1	
		9.53	7.92	18.49	23.37	4.75		.140			
.375	.312	.728	.920	.187	Red	.140	34156*	2-34156-1			
9.53	7.92	18.49	23.37	4.75		.140					
16-14 2,050-5,180 [1.04-2.62]	.033 0.84	5	.237	.312	.728	.865	.125	Blue	.145	696006-1†	—
			6.02	7.92	18.49	21.97	3.18		.145		
		.297	.203	.619	.765	.141	Blue	.145	322994*	2-322994-1	
		7.54	5.16	15.72	19.43	3.58		.170			
		.297	.203	.619	.765	.141	Blue	.170	54367-1	54367-2	
		7.54	5.16	15.72	19.43	3.58		.170			
		.385	.312	.728	.920	.187	Blue	.170	34165*	—	
		9.78	7.92	18.49	23.37	4.75		.170			
		.297	.203	.619	.765	.141	Blue	.170	326741	2-326741-1	
		7.54	5.16	15.72	19.43	3.58		.170			
		.307	.245	.661	.836	.175	Blue	.170	696024-1	696024-2	
		7.80	6.22	16.79	21.23	4.45		.170			
.385	.312	.728	.920	.187	Blue	.170	34166*	2-34166-1			
9.78	7.92	18.49	23.37	4.75		.170					
.385	.312	.728	.920	.187	Blue	.170	34167*	2-34167-1			
9.78	7.92	18.49	23.37	4.75		.170					
12-10 5,180-13,100 [2.62-6.64]	.042 1.07	5	.237	.296	.887	1.095	.203	Yellow	.230	696007-1†	—
			6.02	7.52	22.53	27.81	5.16		.230		
		.406	.296	.887	1.095	.203	Yellow	.230	34176*	2-34176-1	
		10.31	7.52	22.53	27.81	5.16		.230			

*Available in small packaging quantities.

† Gold

Note: "C" dimension applies from edge of metal wire barrel to center of stud hole.



PLASTI-GRIP (Continued)

Flanged Spade Tongue Terminals

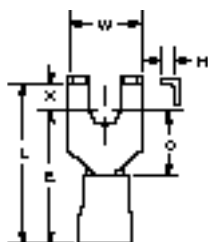

Material

Insulation — Vinyl, UL 94V-0
Terminal Body — Copper per ASTM B-152
Plating — Tin per ASTM B-545

Related Product Data

Insulation Color Code — pg. 4
Packaging Quantities — pg. 4
Performance Specifications — pgs. 4 & 5
Application Tooling — pg. 72

Wire Size Circular Mils [mm ²]	Tongue Material Thickness Max.	Stud Size	Dimensions						Terminal Insulation Color	Wire Insulation Diameter Max.	Part Numbers		
			W	C Min.	E Max.	L Max.	X	H Min.			Loose Piece	Tape Mounted	
22-16 509-3,260 [0.26-1.65]	.033 0.84	6 M3.5	.296	.203	.619	.749	.125	.045	Red	.140 3.56	322249*	1-322249-1	
			7.52	5.16	15.72	19.02	3.18	1.14					
		8 M4	.328	.203	.619	.749	.125	.045	Red	.140 3.56	324560	2-324560-1	
			8.33	5.16	15.72	19.02	3.18	1.14					
			10	.296	.203	.619	.749	.125	.045	Red	.140 3.56	1-322249-0	1-322249-9
				7.52	5.16	15.72	19.02	3.18	1.14				
16-14 2,050-5,180 [1.04-2.62]	.033 0.84	6 M3.5	.294	.203	.619	.749	.125	.047	Blue	.170 4.32	324165*	2-324165-1	
			7.47	5.16	15.72	19.02	3.18	1.19					
		8 M4	.294	.203	.668	.798	.125	.047	Blue	.250 6.35	—	2-324165-4	
			7.47	5.16	16.97	20.27	3.18	1.19					
			10	.294	.203	.619	.749	.125	.047	Blue	.170 4.32	53874-1	53874-2
				7.47	5.16	15.72	19.02	3.18	1.19				
12-10 5,180-13,100 [2.62-6.64]	.042 1.07	6 M3.5	.296	.250	.841	1.017	.171	.052	Yellow	.230 5.84	324581*	1-324581-1	
			7.52	6.35	21.36	25.83	4.34	1.32					
		8 M4	.416	.250	.841	1.017	.171	.052	Yellow	.230 5.84	324172*	1-324172-0	
			10.57	6.35	21.36	25.83	4.34	1.32					
			10	.416	.250	.841	1.017	.171	.052	Yellow	.250 6.35	52856	52856-1
				10.57	6.35	21.36	25.83	4.34	1.32				

*Available in small packaging quantities.

Note: "C" dimension applies from edge of metal wire barrel to center of stud hole.

PLASTI-GRIP



PLASTI-GRIP (Continued)

Short Spring Spade Tongue Terminals



Material

Insulation — Vinyl, UL 94V-0
Terminal Body — Phosphor Bronze per ASTM B-139 for wire sizes 24 to 14 Brass per ASTM B-36 for wire sizes 12 to 10
Plating — Tin per ASTM B-545 except where noted

Related Product Data

Insulation Color Code — pg. 4
Packaging Quantities — pg. 4
Performance Specifications — pgs. 4 & 5
Application Tooling — pg. 72

Wire Size Circular Mils [mm ²]	Tongue Material Thickness Max.	Stud Size	Dimensions					Terminal Insulation Color	Wire Insulation Diameter Max.	Part Numbers	
			W	C Min.	E Max.	L Max.	X			Loose Piece	Tape Mounted
24-20 320-1,290 [0.16-0.65]	.025 0.64	4	.203 5.16	.219 5.56	.624 15.85	.744 18.90	.115 2.92	White	.125 3.18	—	53829-2
22-16 509-3,260 [0.26-1.65]	.033 0.84	4	.203 5.16	.250 6.35	.666 16.92	.811 20.60	.140 3.56	Red	.140 3.56	52947*	52947-1
		5 M3	.250 6.35	.250 6.35	.666 16.92	.811 20.60	.140 3.56	Red	.140 3.56	52948*	52948-1
		6 M3.5	.234 5.94	.250 6.35	.666 16.92	.811 20.60	.140 3.56	Red	.140 3.56	53240-1*	53240-2
			.250 6.35	.250 6.35	.666 16.92	.811 20.60	.140 3.56	Red	.140 3.56	52949*	52949-1
		6 M3.5	.250 6.35	.250 6.35	.715 18.16	.860 21.84	.140 3.56	Red	.200 5.08	52949-2	52949-3
			.244 6.20	.281 7.14	.697 17.70	.872 22.15	.170 4.32	Red	.140 3.56	53241-1	53241-2
		8 M4	.375 9.53	.281 7.14	.697 17.70	.872 22.15	.170 4.32	Red	.140 3.56	52950*	52950-1
			.375 9.53	.281 7.14	.746 18.95	.921 23.39	.170 4.32	Red	.200 5.08	52950-2	52950-3
		10	.294 7.47	.281 7.14	.697 17.70	.920 23.37	.218 5.54	Red	.140 3.56	53242-1*	53242-2
			.294 7.47	.281 7.14	.746 18.95	.969 24.61	.218 5.54	Red	.200 5.08	53242-5	53242-6
		10	.406 10.31	.281 7.14	.697 17.70	.920 23.37	.218 5.54	Red	.140 3.56	52951*	52951-1
			.406 10.31	.281 7.14	.746 18.95	.969 24.61	.218 5.54	Red	.200 5.08	—	52951-3
		6 M3.5	.250 6.35	.250 6.35	.666 16.92	.811 20.60	.140 3.56	Blue	.170 4.32	52955*	52955-1
			.250 6.35	.250 6.35	.715 18.16	.860 21.84	.140 3.56	Blue	.250 6.35	52955-2	52955-3
		6 M3.5	.250 6.35	.250 6.35	.715 18.16	.860 21.84	.140 3.56	Blue	.250 6.35	52955-4 ¹	—
			.244 6.20	.281 7.14	.697 17.70	.872 22.15	.170 4.32	Blue	.170 4.32	53244-1*	53244-2
8 M4	.244 6.20	.281 7.14	.746 18.95	.921 23.39	.170 4.32	Blue	.250 6.35	—	53244-4		
	.375 9.53	.281 7.14	.697 17.70	.872 22.15	.170 4.32	Blue	.170 4.32	52956*	52956-1		
8 M4	.375 9.53	.281 7.14	.746 18.95	.921 23.39	.170 4.32	Blue	.250 6.35	52956-2*	52956-3		
	.294 7.47	.281 7.14	.697 17.70	.920 23.37	.218 5.54	Blue	.170 4.32	53245-1	53245-2		
10	.294 7.47	.281 7.14	.746 18.95	.969 24.61	.218 5.54	Blue	.250 6.35	—	53245-6		
	.406 10.31	.281 7.14	.697 17.70	.920 23.37	.218 5.54	Blue	.170 4.32	52957*	52957-1		
10	.406 10.31	.281 7.14	.746 18.95	.969 24.61	.218 5.54	Blue	.250 6.35	52957-2	52957-3		

*Available in small packaging quantities.

¹Terminal body plating— Gold per MIL-G-45204 over Nickel per QQ-N-290.

Note: "C" dimension applies from edge of metal wire barrel to center of stud hole.

PLASTI-GRIP



PLASTI-GRIP (Continued)

Short Spring Spade Tongue Terminals

(Continued)

Wire Size Circular Mils [mm ²]	Tongue Material Thickness Max.	Stud Size	Dimensions					Terminal Insulation Color	Wire Insulation Diameter Max.	Part Numbers	
			W	C Min.	E Max.	L Max.	X			Loose Piece	Tape Mounted
12-10 5,180-13,100 [2.62-6.64]	.042 1.07	6 M3.5	.250 6.35	.174 4.42	.775 19.69	.959 24.36	.179 4.55	Yellow	.200 5.08	52961*	52961-1
			.250 6.35	.174 4.42	.775 19.69	.959 24.36	.179 4.55	Yellow	.250 6.35	53246-1*	53246-2
			.250 6.35	.174 4.42	.775 19.69	.959 24.36	.179 4.55	Yellow	.250 6.35	53246-3 ¹	—
		8 M4	.312 7.92	.276 7.01	.877 22.28	1.052 26.72	.170 4.32	Yellow	.250 6.35	53247-1*	53247-2
			.375 9.53	.276 7.01	.877 22.28	1.052 26.72	.170 4.32	Yellow	.200 5.08	52962*	52962-1
			.375 9.53	.276 7.01	.936 23.77	1.111 28.22	.170 4.32	Yellow	.300 7.62	52962-2	52962-3
		10	.312 7.92	.276 7.01	.877 22.28	1.100 27.94	.218 5.54	Yellow	.250 6.35	53248-1	53248-2
			.406 10.31	.276 7.01	.877 22.28	1.100 27.94	.218 5.54	Yellow	.200 5.08	52963	52963-1
			.406 10.31	.276 7.01	.877 22.28	1.100 27.94	.218 5.54	Yellow	.250 6.35	52963-2*	52963-3
			.406 10.31	.276 7.01	.936 23.77	1.159 29.44	.218 5.54	Yellow	.300 7.62	52963-4	52963-5

*Available in small packaging quantities.

¹Terminal body plating— Gold per MIL-G-45204 over Nickel per QQ-N-290.

Note: "C" dimension applies from edge of metal wire barrel to center of stud hole.

Long Spring Spade Tongue Terminals

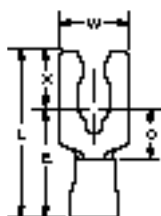

Material

Insulation— Vinyl, UL 94V-0
Terminal Body— Phosphor Bronze per ASTM B-139 for wire sizes 22 to 14 Brass per ASTM B-36 for wire sizes 12 to 10
Plating— Tin per ASTM B-545

Related Product Data

Insulation Color Code— pg. 4
Insulation Packaging Quantities— pg. 4
Performance Specifications— pgs. 4 & 5
Application Tooling— pg. 72

Wire Size Circular Mils [mm ²]	Tongue Material Thickness Max.	Stud Size	Dimensions					Terminal Insulation Color	Wire Insulation Diameter Max.	Part Numbers	
			W	C Min.	E Max.	L Max.	X			Loose Piece	Tape Mounted
22-16 509-3,260 [0.26-1.65]	.033 0.84	6 M3.5	.250 6.35	.238 6.05	.664 16.87	.945 24.00	.276 7.01	Red	.140 3.56	52453*	52453-1
		8 M4	.281 7.14	.270 6.86	.696 17.68	.991 25.17	.290 7.37	Red	.140 3.56	52454*	52454-1
		10	.343 8.71	.283 7.19	.709 18.01	1.017 25.83	.303 7.70	Red	.140 3.56	52455*	52455-1
16-14 2,050-5,180 [1.04-2.62]	.033 0.84	6 M3.5	.250 6.35	.238 6.05	.664 16.87	.945 24.00	.276 7.01	Blue	.170 4.32	52463*	52463-1
		8 M4	.281 7.14	.270 6.86	.696 17.68	.991 25.17	.290 7.37	Blue	.170 4.32	52464*	52464-1
		10	.343 8.71	.283 7.19	.709 18.01	1.017 25.83	.303 7.70	Blue	.170 4.32	52465*	52465-1
12-10 5,180-13,100 [2.62-6.64]	.042 1.07	8 M4	.375 9.53	.273 6.93	.874 22.20	1.174 29.82	.295 7.49	Yellow	.200 5.08	52474	52474-1
		10	.375 9.53	.305 7.75	.906 23.01	1.219 30.96	.308 7.82	Yellow	.200 5.08	52475	52475-1
			.375 9.53	.305 7.75	.965 24.51	1.278 32.46	.308 7.82	Yellow	.300 7.62	—	52475-3

*Available in small packaging quantities.

Note: "C" dimension applies from edge of metal wire barrel to center of stud hole.



PLASTI-GRIP (Continued)

**Slotted Ring
Tongue Terminals**

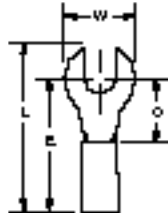

Material

Insulation — Vinyl, UL 94V-0
Terminal Body — Copper per ASTM B-152
Plating — Tin per ASTM B-545

Related Product Data

Insulation Color Code — pg. 4
Packaging Quantities — pg. 4
Performance Specifications — pgs. 4 & 5
Application Tooling — pg. 72

Wire Size Circular Mills [mm ²]	Tongue Material Thickness Max.	Stud Size	Dimensions				Terminal Insulation Color	Wire Insulation Diameter Max.	Part Numbers	
			W	C Min.	E Max.	L Max.			Loose Piece	Tape Mounted
22-16 509-3,260 [0.26-1.65]	.033 0.84	6	.218	.156	.572	.658	Red	.125 3.18	34090	—
		M3.5	5.54	3.96	14.53	16.71				
		8	.281	.250	.666	.782	Red	.140 3.56	324184	2-324184-1
		M4	7.14	6.35	16.92	19.86				

Note: "C" dimension applies from edge of metal wire barrel to center of stud hole.

**Hook Tongue
Terminals**

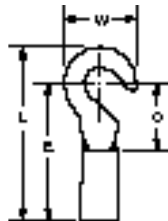

Material

Insulation — Vinyl, UL 94V-0
Terminal Body — Copper per ASTM B-152
Plating — Tin per ASTM B-545

Related Product Data

Insulation Color Code — pg. 4
Packaging Quantities — pg. 4
Performance Specifications — pgs. 4 & 5
Application Tooling — pg. 72

Wire Size Circular Mills [mm ²]	Tongue Material Thickness Max.	Stud Size	Dimensions				Terminal Insulation Color	Wire Insulation Diameter Max.	Part Numbers	
			W	C Min.	E Max.	L Max.			Loose Piece	Tape Mounted
16-14 2,050-5,180 [1.04-2.62]	.033 0.84	8	.343	.281	.697	.871	Blue	.170 4.32	320263	2-320263-1
		M4	8.71	7.14	17.70	22.12				

Note: "C" dimension applies from edge of metal wire barrel to center of stud hole.

PLASTI-GRIP



PLASTI-GRIP (Continued)

Flag Tongue Terminals

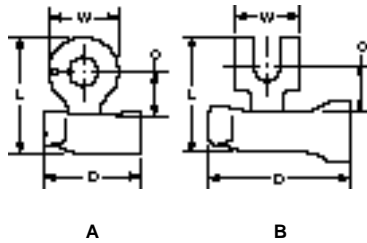

Material

Insulation — Vinyl, UL 94V-0
Color — Natural
Terminal Body — Copper per ASTM B-152
Plating — Tin per ASTM B-545

Related Product Data

Insulation Color Code — pg. 4
Packaging Quantities — pg. 4
Performance Specifications — pgs. 4 & 5
Application Tooling — pg. 72

Wire Size Circular Mills [mm ²]	Tongue Material Thickness Max.	Style	Stud Size	Dimensions				Terminal Insulation Stripe Color	Wire Insulation Diameter Max.	Part Numbers	
				W	C Min.	L Max.	D Max.			Loose Piece	Tape Mounted
20-16HD ¹ 810-3,260 [0.41-1.65]	.042 1.07	A	14	.500 12.70	.266 6.76	.749 19.02	.695 17.65	Green	.170 4.32	322307	
16-14 2,050-5,180 [1.04-2.62]	.033 0.84	B	10	.385 9.78	.272 6.91	.741 18.82	.695 17.65	Blue	.170 4.32	322834	
		A	14	.500 12.70	.266 6.76	.749 19.02	.695 17.65	Blue	.170 4.32	322310	
16-14HD ¹ 2,050-5,180 [1.04-2.62]	.050 1.27	A	10	.500 12.70	.266 6.76	.810 20.57	.775 19.69	Black	.230 5.84	322312	
			14	.500 12.70	.266 6.76	.810 20.57	.775 19.69	Black	.230 5.84	322313	
12-10 5,180-13,100 [2.62-6.64]	.042 1.07	A	10	.500 12.70	.266 6.76	.812 20.62	.775 19.69	Yellow	.230 5.84	322315	
			14	.500 12.70	.266 6.76	.812 20.62	.775 19.69	Yellow	.230 5.84	322316	
			14	.500 12.70	.266 6.76	.812 20.62	.775 19.69	Yellow	.280 7.11	322395	

¹Heavy Duty for extra mechanical strength.

Multiple Stud Terminals

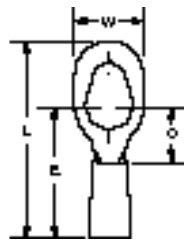

Material

Insulation — Vinyl, UL 94V-0
Terminal Body — Copper per ASTM B-152
Plating — Tin per ASTM B-545

Related Product Data

Insulation Color Code — pg. 4
Packaging Quantities — pg. 4
Performance Specifications — pgs. 4 & 5
Application Tooling — pg. 72

Wire Size Circular Mills [mm ²]	Tongue Material Thickness Max.	Stud Size	Dimensions				Terminal Insulation Color	Wire Insulation Diameter Max.	Part Numbers	
			W	C Min.	E Max.	L Max.			Loose Piece	Tape Mounted
22-16 509-3,260 [0.26-1.65]	.033 0.84	6-8-10	.325 8.26	.271 6.88	.691 17.55	.969 24.61	Red	.125 3.18	54774-1	54774-2
16-14 2,050-5,180 [1.04-2.62]	.033 0.84	6-8-10	.325 8.26	.271 6.88	.691 17.55	.969 24.61	Blue	.145 3.68	54775-1	54775-2

Note: "C" dimension applies from edge of metal wire barrel to center of stud hole.



PLASTI-GRIP (Continued)

Butt Splices



Material

Insulation — Vinyl, UL 94V-0
Splice Body — Copper per ASTM B-152
Plating — Tin per ASTM B-545

Related Product Data

Insulation Color Code — pg. 4
Packaging Quantities — pg. 4
Performance Specifications — pgs. 4 & 5
Application Tooling — pg. 72

Wire Size Circular Mils ¹ [mm ²]	Dimension L Max.	Splice Insulation Color	Wire Insulation Diameter Max.	Part Numbers		
				Loose Piece	Tape Mounted	
26-22 202-810 [0.10-0.41]	.620 15.75	Yellow	.080 2.03	321026*†	2-321026-1†	
22-18/16-14	1.065 27.05	Red/Blue Stripe	.170 / .115 6.86 / 2.92	696010-1	—	
22-16 ² 509-3,260 [0.26-1.65]	1.065 27.05	Red	.120 3.05	34067*	2-34067-1	
	1.065 27.05	Red	.170 4.32	34243*	1-34243-1	
	1.076 27.33	Natural w/ Red Letters	.120 3.05	324138*	—	
	1.076 27.33	Red	.140 3.56	34070*	1-34070-1	
	1.076 27.33	Natural w/ Red Stripes	.140 3.56	55792-1*	55792-2	
	1.065 27.05	Red	.083 x .171 2.11 x 4.34	34203 ³ *	—	
	.600 15.24	Blue	—	55629-2	—	
	1.065 27.05	Blue	.140 3.56	34068*	2-34068-1	
16-14 2,050-5,180 [1.04-2.62]	1.065 27.05	Natural w/ Blue Letters	.140 3.56	328427*	—	
	1.065 27.05	Blue	.170 4.32	34071*	2-34071-1	
	1.065 27.05	Natural w/ Blue Stripes	.170 4.32	55785-1*	55785-2	
	1.065 27.05	Blue	.215 5.46	35244*	2-35244-1	
	1.105 28.07	Blue	.170 4.32	2-34071-2 ⁴	2-34071-3 ⁴	
	1.065 27.05	Blue	.135 x .245 3.43 x 6.22	34204 ³ *	1-34204-0	
	1.160 29.46	Yellow	.200 5.08	34069	—	
	1.160 29.46	Yellow	.230 5.84	34072*	2-34072-2	
12-10 5,180-13,100 [2.62-6.64]	1.160 29.46	Natural w/ Yellow Stripes	.230 5.84	55793-1*	55793-2	
	1.160 29.46	Yellow	.250 6.35	34945*	—	
	1.160 29.46	Yellow	.300 7.62	326742	—	
	1.200 30.48	Yellow	.250 6.35	2-34945-1 ⁴	2-34945-2 ⁴	
	1.160 29.46	Yellow	.250 / .165 x .315 6.35 / 4.19 x 8.00	321286 ⁵ †	—	
	1.160 29.46	Yellow	.138 x .281 3.51 x 7.14	34205 ³ *	—	
	8	1.340 34.04	Red	.250 6.35	696025-1	—
	6	1.530 38.86	Blue	.330 8.38	696026-1	—

† Not UL or CSA Approved or Listed.

* Available in small packaging quantities.

¹ When using two or more wires in either end of a butt splice, the combined cross sectional area must be within the (CMA) circular mil range listed. (Not UL or CSA Approved with use of multiple wires.)

² 22-16 splices are 22-18 range in accordance with MIL-T-7928.

³ Oval expansion.

⁴ Funnel entry

⁵ Oval expansion at one end; circular expansion at other end.

PLASTI-GRIP



PLASTI-GRIP (Continued)

Parallel Splices



Material

Insulation — Vinyl, UL 94V-0
Splice Body — Copper per ASTM B-152
Plating — Tin per ASTM B-545

Related Product Data

Insulation Color Code — pg. 4
Packaging Quantities — pg. 4
Performance Specifications — pgs. 4 & 5
Application Tooling — pg. 72

Wire Size Circular Mils' [mm ²]	Dimension L Max.	Splice Insulation Color	Wire Insulation Diameter Max.	Part Numbers Loose Piece
22-16 509-3,260 [0.26-1.65]	.760 19.30	Red	.120 3.05	34131*
	.760 19.30	Red	.140 3.56	34132*
16-14 2,050-5,180 [1.04-2.62]	.760 19.30	Blue	.140 3.56	34133*
	.760 19.30	Blue	.170 4.32	34134*
	.760 19.30	Blue	.135 x .245 3.43 x 6.22	34207**
12-10 5,180-13,100 [2.62-6.64]	.843 21.41	Yellow	.200 5.08	34135
	.870 22.10	Yellow	.230 5.84	34136*

*Available in small packaging quantities.

†When using two or more wires in a parallel splice, the combined cross sectional area must be within the (CMA) circular mil area listed.

**Oval expansion.

Shur-Plug
(.093, .156 and .180 Series)

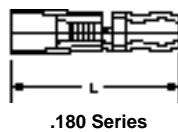
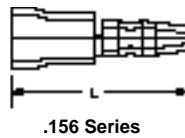
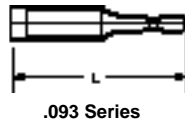

Material (.093 Series)

Insulation — Vinyl, UL 94V-0
Terminal Body — Brass per ASTM B-36

Related Product Data

Insulation Color Code — pg. 4
Packaging Quantities — pg. 4
Performance Specifications — pgs. 4 & 5
Application Tooling — pg. 72

Material (.156 & .180 Series)

Insulation — Vinyl, UL 94V-0
Terminal Body — Copper per ASTM B-152
Plating — Tin per ASTM B-545

Wire Size Circular Mils [mm ²]	Tongue Material Thickness Max.	Series	Dimension L Max.	Terminal Insulation Color	Wire Insulation Diameter Max.	Part Numbers	
						Loose Piece	Tape Mounted
22-16 509-3,260 [0.26-1.65]	—	.093	.812 20.62	Red	.140 3.56	34178	—
16-14 2,050-5,180 [1.04-2.62]	.033 0.84	.156	.800 20.32	Blue	.170 4.32	324227*†	1-324227-0
		.180	.753 19.13	Blue	.170 4.32	324228*†	—

† Not UL or CSA Approved or Listed.

*Available in small packaging quantities.

PLASTI-GRIP (Continued)

3-Way Connector

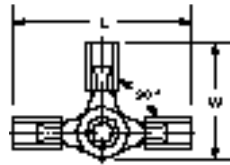

Material

Insulation — Vinyl, UL 94V-0
Terminal Body — Copper per ASTM B-152
Rivet — Brass per QQ-B-626
Plating — Tin per ASTM B-545

Related Product Data

Insulation Color Code — pg. 4
Packaging Quantities — pg. 4
Performance Specifications — pgs. 4 & 5
Application Tooling — pg. 72

Wire Size Circular Mils [mm ²]	Tongue Material Thickness Max.	Dimensions		Terminal Insulation Color	Wire Insulation Diameter Max.	Part Number Loose Piece
		W Max.	L Max.			
16-14 2,050-5,180 [1.04-2.62]	.033 0.84	.877 22.28	1.400 35.56	Blue	.145 3.68	34073*

*Available in small packaging quantities.

PLASTI-GRIP

.250 Tube Cap Assembly

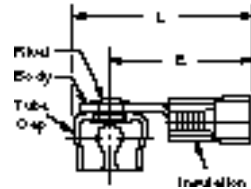

Material

Insulation — Vinyl, UL 94V-0
Terminal Body — Copper per ASTM B-152
Plating — Tin per ASTM B-545
Tube Cap — Copper/Zinc alloy per MIL-C-50
Plating — Tin per ASTM B-545
Rivet — Brass
Plating — Tin per ASTM B-545 over Copper

Related Product Data

Insulation Color Code — pg. 4
Packaging Quantities — pg. 4
Performance Specifications — pgs. 4 & 5
Application Tooling — pg. 72

Wire Size Circular Mils [mm ²]	Tongue Material Thickness Max.	Dimensions		Terminal Insulation Color	Wire Insulation Diameter Max.	Part Number Loose Piece
		E Max.	L Max.			
22-16 509-3,260 [0.26-1.65]	.033 0.84	.666 16.92	.978 24.84	Black	.140 3.56	55137-1†

† Not UL or CSA Approved or Listed.

Wire Pins

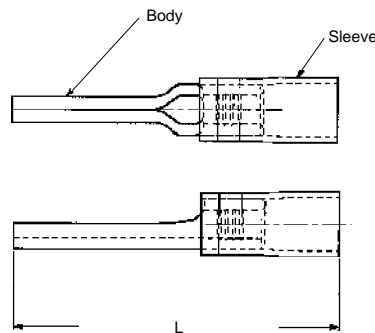

Wire Size Circular Mils [mm ²]	Tab	Dimensions		Terminal Insulation Color	Wire Insulation Diameter Max.	Part Number
		Ins.	L Max.			
22-16	.070 1.78	.140 3.56	.943 23.95	Red	.145 3.68	696116-1 (Tape)
	.071 1.80	.135 3.43	.905 22.99	Red	.145 3.68	165167 (Loose Piece)