

**tyco**

*Electronics*

**Machine Applied Terminations,  
Open Barrel Terminals**  
(Rings, Spades, Pins, Receptacles, Splices, Tabs)  
Catalog 82227 Revised 8-04

**AMP**



**Table of Contents**

<b>Introduction</b> . . . . .	3	<b>AMPLIVAR Splices</b>	
Crimp Configuration . . . . .	4	Introduction . . . . .	43-45
Terminal Stud Hole Size . . . . .	5, 6	9 Serrations . . . . .	46
Description of UL 468A Test Procedures and Requirements for Terminals . . . . .	7	7 Serrations . . . . .	46, 47
<b>Ring Tongue Terminals</b>		5 Serrations . . . . .	47, 48
Introduction . . . . .	8	Miniature Splice . . . . .	48
Insulation Support . . . . .	9-15	Subminiature Splice . . . . .	48
Non-Insulation Support . . . . .	16-18	AMPLIVAR Tooling . . . . .	49, 50
Insulation Piercing . . . . .	19	<b>Pins, Receptacles, Tab and Taper Tab Receptacles Terminals</b>	
Flag . . . . .	20	Introduction . . . . .	51
AMPLIVAR . . . . .	21	<b>Pin Terminals</b> . . . . .	52
<b>Spade Tongue Terminals</b>		<b>Receptacle Terminals</b> . . . . .	53-55
Insulation Support . . . . .	22, 23	<b>SHUR-PLUG Terminals</b>	
Non-Insulation Support . . . . .	24	.156 Diameter . . . . .	56
Hook . . . . .	24	.180 Diameter . . . . .	56
Insulation Piercing . . . . .	25	<b>SHUR-PLUG Receptacle Terminals</b>	
Spring Spade . . . . .	25	.156 Diameter . . . . .	57
Flag . . . . .	25	.180 Diameter . . . . .	57
<b>Splices</b>		<b>Tab Receptacle Terminals</b> . . . . .	58
Introduction . . . . .	26	<b>Taper Tab Receptacle Terminals</b>	
Non-Insulation Support — Side Feed . . . . .	27	78 Series Insulation Support . . . . .	59
Non-Insulation Support — End Feed . . . . .	28	78 Series Insulation Piercing . . . . .	59
Insulation Support . . . . .	29	98 Series Insulation Support . . . . .	59
Insulation Piercing — End Feed . . . . .	29	<b>Contact and Welding Tab Terminals</b>	
Identification Bands . . . . .	30	Introduction . . . . .	60
<b>RTM Crimpband Splices</b>		Miscellaneous Contacts and Weld Tabs . . . . .	61
Introduction . . . . .	31, 32	Brush Contacts . . . . .	62
20 Ridges . . . . .	33	Button Contacts . . . . .	63
14 Ridges . . . . .	33	Grounding Clips . . . . .	63
10 Ridges . . . . .	33	<b>Miscellaneous Terminals</b>	
9 Ridges . . . . .	34	Tab Receptacles — Special . . . . .	64
8 Ridges . . . . .	34	Plug Blade . . . . .	64
7 Ridges . . . . .	34-36	Fuse Receptacles . . . . .	64
6 Ridges . . . . .	37	Wire Strain Relief Clamps . . . . .	65
3 Ridges . . . . .	38	Spark Plug Receptacle . . . . .	65
<b>MTM Crimpband Splices</b>		Thermal Protector Crimp Pin . . . . .	65
Introduction . . . . .	39, 40	Wire Pins . . . . .	66, 67
11 Serrations . . . . .	41	AMPLIVAR Wire Pins with Insulation Support . . . . .	68
9 Serrations . . . . .	41	<b>Application Tooling</b> . . . . .	69-71
7 Serrations . . . . .	42	<b>Part Number Index</b> . . . . .	72-74

## Introduction

### Operating Temperatures of Materials and Finishes

Brass, phosphor bronze and steel are the normal materials for Tyco Electronics terminals. Various finishes are available.

#### Brass

##### Plain

Allowable Connection Temperature: 110°C.

Plain brass is used frequently, where applications have optional environmental conditions.

##### Tin Plated

Allowable Connection Temperature: 110°C.

Tin plating of receptacle and tab creates satisfactory operation at higher temperatures, and in addition protects the connection against corrosion.

##### Silver Plated

Allowable Connection Temperature: 130°C

Silver plated connections allow the highest operating temperature for brass and a higher current carrying capacity than plain and tin plated brass.

#### Phosphor Bronze

##### Plain

Allowable Connection Temperature: 110°C

Phosphor bronze is used in applications where brass would normally be corroded, for example the various freezing mixtures and ammonias.

#### Tin Plated

Allowable Connection Temperature: 110°C

Tin plated phosphor bronze for higher temperatures; additional corrosion protection over plain phosphor bronze.

#### Silver Plated

Allowable Connection Temperature: 130°C

Silver plated connections allow the highest operating temperature for phosphor bronze and higher current carrying capacity than plain and tin plated phosphor bronze.

#### Steel

##### Nickel plated

Allowable Connection Temperature: 250°C

This combination allows a reliable connection at high temperatures, for example in stoves, cooking appliances, etc. To assure optimum performance, these nickel-plated receptacles are used with compatible lead wires and wires and tabs that can be welded to heating units.

Many part numbers are recognized under the Component Program of Underwriters Laboratories, Inc.,  File No. E13288 and File No. LR 7189. Certified by Canadian Standards  Association. Contact Tyco Electronics customer service for a specific part number inquiry.

### Need more information?

Call Technical Support at the numbers listed below.

Technical Support is staffed with specialists well versed in all Tyco Electronics products. They can provide you with:

- Technical support
- Catalogs
- Technical Documents
- Product Samples
- Tyco Electronics Authorized Distributor Locations

### Instant Information by the Tyco Electronics FAX Service 24 hours a day...

Call Technical Support and choose the Tyco Electronics FAX service option at the voice prompt. The information you request will be faxed to you within a few minutes. From the Tyco Electronics FAX service you get:

- Drawings (the drawing number in this case is the part number)
- Instruction Sheets
- Product Specifications
- Latest Revisions of Catalog Pages. (You will be prompted to enter any part number on the old catalog page. The Tyco Electronics FAX service will then fax you the latest catalog page(s) covering this part.
- The list of your closest distributors
- Instructions on how to use the Tyco Electronics FAX service

© Copyright 1989, 1995 and 2004 by Tyco Electronics Corporation. All International Rights Reserved.  
AMP, AMPLIVAR, AMP-O-LECTRIC, AMPOMATOR, SHUR-PLUG, and TYCO are trademarks.  
Specifications subject to change. Consult Tyco Electronics for latest design applications.

**Crimp Configuration Specifications**

**AMPLIVAR**

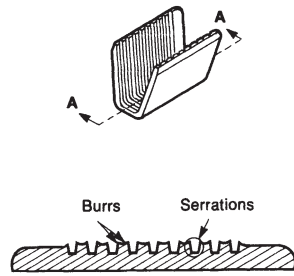

**Standard "F"**

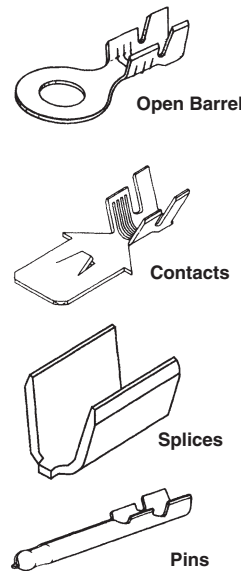

**Insulation Piercing**

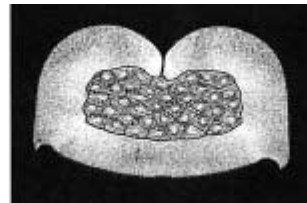
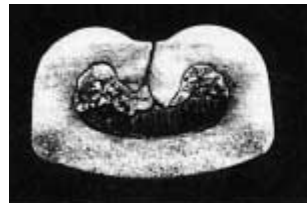
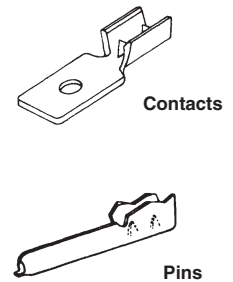

The basic design of the AMPLIVAR Terminals encompasses two main areas, the burrs at the top of the serrations and the serrations themselves. During the crimping operation the burrs pierce the insulation of the magnet wire and extrude the bare conductors into the serrations—creating intimate metal contact.

In a one-step operation the magnet wire is automatically multiple ring stripped of its insulation as it is forced into the serrations during the precisely controlled crimp. The resulting termination produces a high tensile strength, air sealed connection that is as resistant to corrosion as the insulated conductor.

In the standard "F" crimp design, the open barrel consists of two wings that are wrapped around the conductor strands and butted together in a tight seam. Applied with Match-Mated tooling, the "F" Crimp offers the optimum combination of mechanical strength and electrical conductivity. This method of termination also assures maximum resistance to vibration and corrosion.

The insulation support feature was developed by Tyco Electronics for applications where vibration tends to be excessive. This design offers the same fine quality characteristics found in the standard line plus firm, fully circumferential support to the wire insulation.

The insulation piercing line enjoys a durable popularity with electrical circuitry manufacturers because of the simplicity of attachment. The barrel contains two perpendicular lances that drive through the wire insulation to make contact with the conductor within.

Tensile characteristics vary, depending on the type of wire insulation. Because the barrel wraps around the insulation, it deters insulation fraying. The insulation piercing line is a low cost, high speed attachment suitable for many requirements.

In general, insulation piercing terminals can be used where high currents, intensive vibration and mechanical loads are not critical factors on both stranded and tinsel wire.

















**Terminal Stud Hole Size**

**Use to Select Proper Size Terminal**





The chart shows sizes and dimensions of various studs and the corresponding terminal stud hole sizes used with Tyco Electronics devices.

For example, with stud #5 (.125 Diameter), use Tyco Electronics device listed for #5 stud (.129 Hole Diameter).

Terminal stud hole sizes may easily be checked by fitting sample terminal to black circle.

Stud Size		Stud Dia.	Minimum Terminal Hole Diameter	
U.S. Cust.	Metric			
#0		.060		.064
#1		.073		.077
#2	M2	.086		.090
#3		.099		.103
#4		.112		.116
#5	M3	.125		.129
#6	M3.5	.138		.142
#8	M4	.164		.168
#10		.190		.194
#12		.216		.220
#14		.242		.247
1/4"	M6	.250		.260
5/16"	M8	.312		.323
3/8"		.375		.385
7/16"		.437		.448
1/2"	M12	.500		.510

**Terminal Stud Hole Size** (Continued)

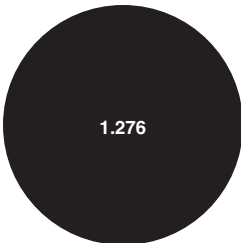
Stud Size		Stud Dia.	Minimum Terminal Hole Diameter
U.S. Cust.	Metric		
5/8"	M16	.625	
3/4"		.750	
7/8"	M22	.875	
1"		1.000	
1-1/8"		1.125	
1-1/4"		1.250	

## Description of UL 486A Test Procedures and Requirements for Terminals

### Wire Size Range

AWG 22 to 2

### Test Sequences

#### Test Group 1

##### Mechanical Sequence

1. Secureness
2. Pullout

#### Test Group 2

##### Mechanical Sequence

1. Secureness
2. Static Heat
3. Pullout

### Pullout Test Requirements

Terminal must not be separate from wire when subjected to the listed load for one minute.

Wire Size AWG	Pullout Force (lbs.)
22	8
20	13
18	20
16	30
14	50
12	70
10	80
8	90
6	100
4	140
2	180

**Note:** Testing conducted on non-plated copper wire with UL approved insulation.

### Static Heat Test Requirements

Wire Size AWG	Test Current (Amperes)
22	9
20	12
18	17
16	18
14	30
12	35
10	50
8	70
6	95
4	125
2	170

#### Requirement:

Connector temperatures must not exceed the ambient temperature plus 50°C [90°F] after stability is attained.

#### Stability:

A test sample is considered to have attained a stable temperature when three readings taken at not less than 10 minute intervals show no more than a 2°C [3.6°F] variation between any two readings.

### Secureness Test Requirements

Wire Size AWG	Bushing Dia.	Height	Weight (lbs.)
18-16	1/4	10 1/4	2
14	3/8	11	3
12-10	3/8	11	5
8	3/8	11	8
6	1/2	11 3/4	18
4	1/2	11 3/4	30
2	9/16	12 1/2	30

**Note:** Test Duration = 30 Minutes

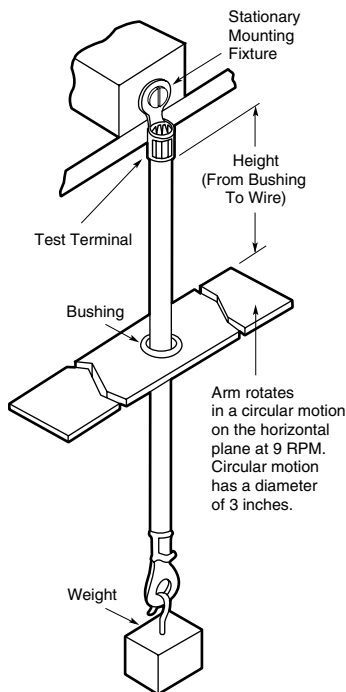

**Introduction**

Open Barrel Rings and Spades

**Product Facts**

- Reproducible crimping results
- High quality
- Reduced manufacturing costs
- No soldering required
- Proven crimp technology
- Large range of product configurations
- Excellent mechanical and electrical performance
- Recognized under the Component Recognition Program of Underwriters Laboratories Inc., File No. E13288, unless otherwise specified 
- Certified by Canadian Standards Association, File No. LR 7189, unless otherwise specified 

**Applications**

- Appliances
- Machine tools
- Automotive

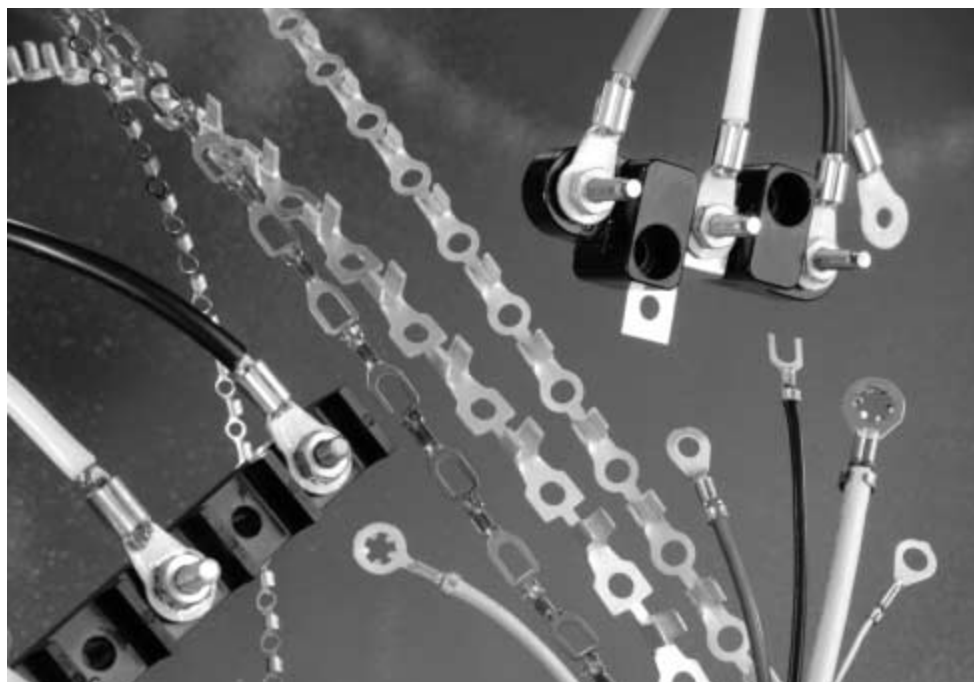

Tyco Electronics open barrel rings and spades are manufactured in strip form and supplied on reels for Automachine termination. In the standard “F” crimp configuration, the open barrel consists of two “U” shaped wings that are crimped around the conductor strands and butted together into a tight seam. The crimping action of the Tyco Electronics application equipment is a precise operation that creates the proper crimp with each cycle of the machine. This ensures uniformity of all the crimp terminations.

The insulation support was a Tyco Electronics developed feature for applications where vibration tends to be excessive. The insulation support consists of two additional “U” shaped wings which are wrapped around the wire insulation. This prevents harmful flexing of the wire at the termination point where the wire is rigidly crimped to the wire barrel and deters fraying of the insulation. Because it increases the already signif-

icant tensile strength of the conductor crimp, the vibration resistance is great enough for more severe applications.

Tyco Electronics Open Barrel Rings and Spades are designed for wire sizes ranging from 28 AWG to 6 AWG. They come in a variety of stud sizes. These terminals are made from a variety of base materials and platings depending on your application (i.e. ambient temperature, humidity, and chemical exposure).

To help you choose the Tyco Electronics product best suited to your requirements, the following information about each terminal is shown in tabular form: wire size range, insulation diameter, stud size, stock thickness, type of base material, plating and physical dimensions.

Tyco Electronics has standardized the product listed in this catalog section. If you do not see a terminal to fit your application, please contact your Tyco Electronics Sales Engineer.

**Open Barrel Insulation Piercing Terminals**

The insulation piercing line of terminals enjoys popularity because of the simplicity of termination. The barrel contains two perpendicular lances that are driven through the wire insulation to make contact with the conductor. Consequently, wire stripping is eliminated and a one step circuitry termination is accomplished.

Tensile characteristics vary, depending on the type of wire insulation. Since the barrel wraps around the insulation, it deters insulation fraying. The insulation piercing line is a low-cost, high-speed termination, suitable for many applications.

In general, insulation piercing terminals can be used on both stranded and tinsel wire, where high currents, intense vibration and mechanical loads are not critical factors.



**Ring Tongue Terminals, Insulation Support**

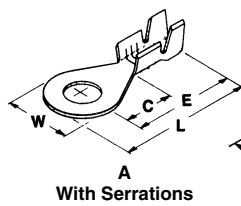

**A**  
With Serrations

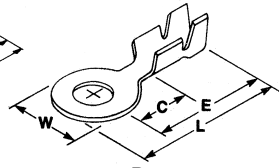

**B**  
Circular Without Serrations

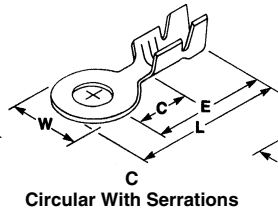

**C**  
Circular With Serrations

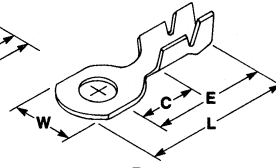

**D**  
Flat Sided

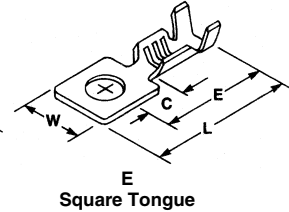

**E**  
Square Tongue

Type	Wire Range		Insul. Size	Stud Size/ Dia.	Stock Thk.	Material and Finish	Dimensions				Part Number				
	AWG	mm <sup>2</sup>					W	L	E	C					
E	26-24	0.12-0.6	.035-.065 0.89-1.65	.065 1.65	.012 0.31	Brass	.156 3.96	.375 9.53	.295 7.49	.109 2.77	61652-1				
				.094 2.39	.012 0.31	Brass	.156 3.96	.375 9.53	.295 7.49	.109 2.77	61653-1				
B	26-22	0.12-0.4	.040-.060 1.02-1.52	.100 2.54	.014 0.36	Tin Plated Brass	.190 4.83	.425 10.80	.330 8.38	.130 3.30	60007-2				
				4	.014 0.36	Tin Plated Brass	.190 4.83	.425 10.80	.330 8.38	.130 3.30	42547-2				
				.100 2.54	.016 0.41	Brass	.190 4.83	.455 11.56	.365 9.27	.130 3.30	61312-1				
				.100 2.54	.016 0.41	Nickel Plated Brass	.190 4.83	.456 11.58	.365 9.27	.130 3.30	61312-2				
D	26-20	0.12-0.6	.048-.078 1.22-1.98	.142 3.61	.020 0.51	Tin Plated Brass	.250 6.35	.565 14.35	.444 11.28	.237 6.02	60123-2				
				4	.020 0.51	Tin Plated Brass	.290 7.37	.630 16.00	.485 12.32	.250 6.35	41579				
				6	.020 0.51	Tin Plated Brass	.290 7.37	.630 16.00	.485 12.32	.250 6.35	41580				
				8	.020 0.51	Tin Plated Brass	.290 7.37	.630 16.00	.485 12.32	.250 6.35	41581				
				10	.020 0.51	Tin Plated Brass	.290 7.37	.630 16.00	.485 12.32	.250 6.35	41582				
				A	24-20	0.2-0.6	.048-.078 1.22-1.98	6	.014 0.36	Tin Plated Brass	.250 6.35	.590 14.99	.440 11.18	.220 5.59	60553-1
10	.014 0.36	Tin Plated Brass	.300 7.62					.590 14.99	.440 11.18	.220 5.59	60555-1				
8	.020 0.51	Tin Plated Brass	.312 7.93					.770 19.56	.615 15.62	.405 10.29	42508-2				
10	.020 0.51	Tin Plated Brass	.312 7.93					.770 19.56	.615 15.62	.405 10.29	42164-2				
12	.020 0.51	Tin Plated Brass	.312 7.93					.770 19.56	.615 15.62	.405 10.29	63721-1				
B	22-20	0.3-0.6	.070-.120 1.78-3.05					.126 3.20	.020 0.51	Tin Plated Brass	.210 5.33	.460 11.68	.355 9.02	.135 3.43	62638-1
				.120 3.05	.020 0.51	Brass	.210 5.33	.532 13.51	.427 10.85	.135 3.43	109453-1				
				.050-.110 1.27-2.79	6	.020 0.51	Brass	.210 5.33	.532 13.51	.427 10.85	.135 3.43	109453-3			
					.100-.150 2.54-3.81	6	.020 0.51	Brass	.210 5.33	.532 13.51	.427 10.85	.135 3.43	109454-1		
				.060-.110 1.52-2.79		6	.020 0.51	Tin Plated Brass	.296 7.52	.642 16.31	.494 12.55	.234 5.94	40697		
					8	.020 0.51	Tin Plated Brass	.296 7.52	.642 16.31	.494 12.55	.234 5.94	40698			
				.070-.100 1.78-2.54	5/16"	.030 0.76	Tin Plated Brass	.468 11.89	.982 24.94	.748 19.00	.437 11.10	41013			
					1/4"	.030 0.76	Tin Plated Brass	.468 11.89	.982 24.94	.748 19.00	.437 11.10	41711			
				A	22-18	0.3-0.9	.080-.110 2.03-2.79	4	.020 0.51	Tin Plated Brass	.296 7.52	.662 16.81	.514 13.06	.234 5.04	63797-1
								6	.020 0.51	Tin Plated Brass	.296 7.52	.662 16.81	.514 13.06	.234 5.04	42037
8	.020 0.51	Brass	.296 7.52					.662 16.81	.514 13.06	.234 5.04	42036-1				
8	.020 0.51	Tin Plated Brass	.296 7.52					.662 16.81	.514 13.06	.234 5.04	42037-1				
10	.020 0.51	Brass	.296 7.52					.662 16.81	.514 13.06	.234 5.04	42036-2				
10	.020 0.51	Tin Plated Brass	.296 7.52					.662 16.81	.514 13.06	.234 5.04	42037-2				
.120-.170 3.05-4.32	8	.020 0.51	Nickel Plated Steel					.296 7.52	.637 16.18	.494 12.55	.234 5.04	485003-1			

**Note:** The part numbers listed are for use with existing machine models. For AMP-O-LECTRIC Model G applicators part numbers, call the Technical Support Center at 1-800-522-6752.

**Ring Tongue Terminals, Insulation Support** (Continued)

Ring Tongue Terminals

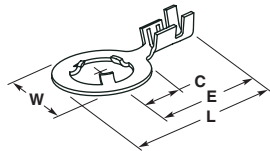

**D**  
Stud Retaining

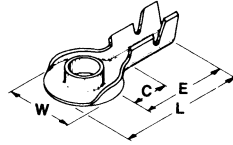

**E**  
Extruded

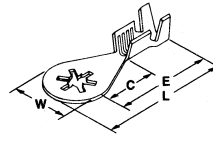

**F**  
Anti-Rotational

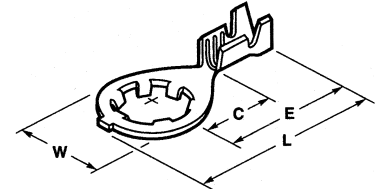

**G**  
Stud Retaining

Type	Wire Range		Insul. Size	Stud Size/ Dia.	Stock Thk.	Material and Finish	Dimensions				Part Number
	AWG	mm <sup>2</sup>					W	L	E	C	
D	24-20	0.2-0.6	.045-.080 1.14-2.03	10	.014 0.36	Tin Plated Brass	.375	.634	.447	.250	61705-1
							9.53	16.11	11.35	6.35	
E	20-18	0.5-0.9	.075-.110 1.91-2.79	10	.020 0.51	Tin Plated Brass	.335	.650	.468	.205	40894
							8.51	16.51	11.89	5.21	
F	22-18	0.3-0.9	.080-.120 2.03-3.05	8	.025 0.69	Tin Plated Steel	.370	.772	.587	.282	640204-1
							9.40	19.61	14.91	7.16	
						Nickel Plated Steel	.370	.772	.587	.282	640204-2
							9.40	19.61	14.91	7.16	
						Tin Plated Steel	.370	.772	.587	.282	640271-1
							9.40	19.61	14.91	7.16	
Brass	.370	.772	.587	.282	61588-1						
	9.40	19.61	14.91	7.16							
G	22-16	0.3-1.4	.100-.140 2.54-3.56	8	.025 0.64	Tin Plated Brass	.370	.772	.587	.282	61436-1
							9.40	19.61	14.91	7.16	
						Tin Plated Steel	.370	.772	.587	.282	61436-2
							9.40	19.61	14.91	7.16	
						Tin Plated Brass	.455	.805	.587	.282	61283-1
							11.56	20.45	14.91	7.16	
Brass	.370	.772	.587	.282	350509-1						
	9.40	19.61	14.91	7.16							

**Note:** The part numbers listed are for use with existing machine models. For AMP-O-LECTRIC Model G applicators part numbers, call the Technical Support Center at 1-800-522-6752.

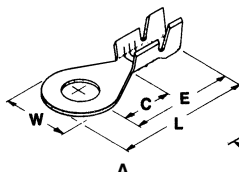

**A**  
With Serrations

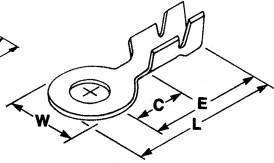

**B**  
Circular Without Serrations

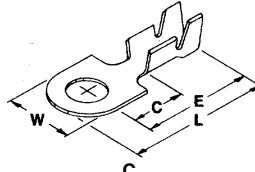

**C**  
"D" Shape

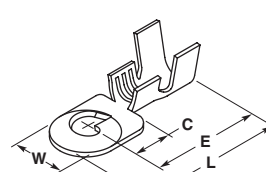

**D**  
Grounding

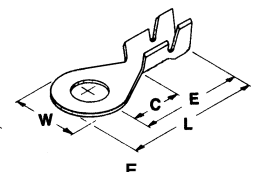

**E**  
Without Serrations

Type	Wire Range		Insul. Size	Stud Size/ Dia.	Stock Thk.	Material and Finish	Dimensions				Part Number
	AWG	mm <sup>2</sup>					W	L	E	C	
D	20-16	0.5-1.4	.075-.120 1.91-3.05	6 x 20 Screw	.020 0.51	Stainless Steel	.270 6.86	.590 14.99	.468 11.89	.218 5.54	61904-1
C	20-16	0.5-1.4	.075-.120 1.91-3.05	8	.020 0.51	Tin Plated Brass	.270 6.86	.603 15.32	.468 11.89	.218 5.54	40888
A	20-16	0.5-1.4	.100-.140 2.54-3.56	10	.030 0.76	Tin Plated Brass	.342 8.67	.784 19.91	.613 15.57	.312 7.93	40955
B	20-16	0.5-1.4	.075-.110 1.91-2.79	2.52	.099 0.64	Brass	.246 6.25	.460 11.68	.352 8.94	.165 4.19	41406
A	20-16	0.5-1.4	.100-.140 2.54-3.56	8	.025 0.64	Tin Plated Brass	.342 8.69	.784 19.91	.613 15.57	.312 7.93	41456
E	20-16	0.5-1.4	.080-.120 2.03-3.05	10	.025 0.64	Tin Plated Brass	.342	.784	.613	.312	160102-2
							8.69	19.91	15.57	7.93	
E	20-16	0.5-1.4	.080-.120 2.03-3.05	12	.025 0.64	Tin Plated Brass	.342	.784	.613	.312	160108-2
							8.69	19.91	15.57	7.93	
B	20-16	0.5-1.4	.090-.120 2.29-3.05	6	.025 0.64	Brass	.230	.460	.352	.165	61764-1
							5.59	11.68	8.94	4.19	
						Tin Plated Brass	.230	.460	.352	.165	61386-1
							5.59	11.68	8.94	4.19	
Brass	.246	.467	.352	.165	41471						
	6.25	11.86	8.94	4.19							
Tin Plated Brass	.246	.467	.352	.165	41472						
	6.25	11.86	8.94	4.19							

**Note:** The part numbers listed are for use with existing machine models. For AMP-O-LECTRIC Model G applicators part numbers, call the Technical Support Center at 1-800-522-6752.

**Ring Tongue Terminals, Insulation Support** (Continued)

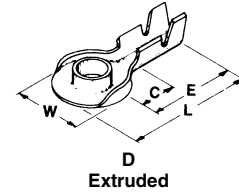
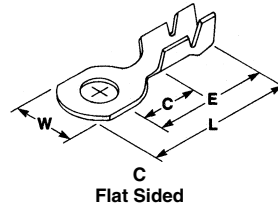
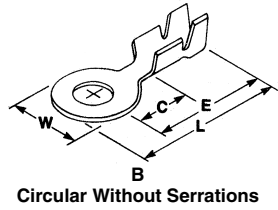
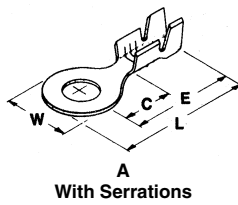

Type	Wire Range		Insul. Size	Stud Size/ Dia.	Stock Thk.	Material and Finish	Dimensions				Part Number
	AWG	mm <sup>2</sup>					W	L	E	C	
C	20-16	0.5-1.4	.075-.110 1.91-2.79	.099 2.52	.025 0.64	Brass	.204 5.18	.460 11.68	.352 8.94	.165 4.19	42065
B	20-16	0.5-1.4	.075-.110 1.91-2.79	.132 3.35	.025 0.64	Brass	.246 6.25	.460 11.68	.352 8.94	.165 4.19	42721-1
C	20-16	0.5-1.4	.075-.110 1.91-2.79	.099 2.52	.025 0.64	Tin Plated Brass	.185 4.70	.460 11.68	.352 8.94	.165 4.19	63514-1
A	20-16	0.5-1.4	.100-.140 2.54-3.56	10	.030 0.76	Br. Tin Plated Brass	.342 8.69	.784 19.91	.612 15.54	.312 7.92	640008-1
C	20-16	0.5-1.4	.080-.120 2.03-3.05	2	.020 0.51	Nickel Plated Steel	.256 6.50	.935 23.75	.748 19.00	.437 11.10	640082-1
A	20-16	0.5-1.4	.080-.120 2.03-3.05	1/4"	.020 0.51	Brass	.468 11.89	.982 24.94	.748 19.00	.437 11.10	60700-3
			.080-.120 2.03-3.05	1/4"	.020 0.51	Tin Plated Brass	.468 11.89	.982 24.94	.748 19.00	.437 11.10	60700-2
			.100-.140 2.54-3.56	10	.020 0.51	Brass	.342 8.69	.764 19.41	.593 15.06	.305 7.75	60394-1
			.110-.140 2.79-3.56	6	.030 0.76	Tin Plated Brass	.342 8.69	.764 19.41	.593 15.06	.305 7.75	42933-2
A	18-14	0.8-2.0	.100-.140 2.54-3.56	6	.030 0.76	Tin Plated Brass	.342 8.69	.784 19.91	.613 15.57	.305 7.75	40723
			.100-.140 2.54-3.56	8	.030 0.76	Brass	.342 8.69	.784 19.91	.613 15.57	.305 7.75	40660
B	18-14	0.8-2.0	.100-.140 2.54-3.56	8	.030 0.76	Tin Plated Brass	.342 8.69	.784 19.91	.613 15.57	.305 7.75	40724
			.100-.140 2.54-3.56	12	.030 0.76	Tin Plated Brass	.342 8.69	.784 19.91	.613 15.57	.305 7.75	63872-1
A	18-14	0.8-2.0	.100-.140 2.54-3.56	10	.030 0.76	Brass	.342 8.69	.784 19.91	.613 15.57	.305 7.75	40661
			.100-.140 2.54-3.56	10	.030 0.76	Tin Plated Brass	.342 8.69	.784 19.91	.613 15.57	.305 7.75	40725
			.120-.170 3.05-4.32	6	.020 0.51	Brass	.296 7.52	.640 16.26	.494 12.55	.234 5.94	41558*
			.120-.170 3.05-4.32	6	.020 0.51	Pre-Ni Plated Steel	.296 7.52	.640 16.26	.494 12.55	.234 5.94	41558-1*
D	18-14	0.8-2.0	.120-.170 3.05-4.32	.194 4.93	.020 0.51	Brass	.335 8.51	.650 16.51	.468 11.89	.205 5.21	60546-1

\*Not recommended for 2 wires.

**Note:** The part numbers listed are for use with existing machine models. For AMP-O-LECTRIC Model G applicators part numbers, call the Technical Support Center at 1-800-522-6752.

**Ring Tongue Terminals, Insulation Support** (Continued)

Ring Tongue Terminals

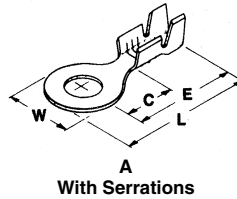

Type	Wire Range		Insul. Size	Stud Size/ Dia.	Stock Thk.	Material and Finish	Dimensions				Part Number			
	AWG	mm <sup>2</sup>					W	L	E	C				
A	18-14	0.8-2.0	.105-.170 2.67-4.32	6	.020 0.51	Brass	.296 7.52	.677 17.20	.529 13.44	.234 5.94	109452-1			
				6	.020 0.51	Pre-Tin Plated Brass	.296 7.52	.677 17.20	.529 13.44	.234 5.94	109452-2			
				8	.020 0.51	Brass	.296 7.52	.677 17.20	.529 13.44	.234 5.94	109452-3			
				8	.020 0.51	Pre-Tin Plated Brass	.296 7.52	.677 17.20	.529 13.44	.234 5.94	109452-4			
				10	.020 0.51	Brass	.296 7.52	.677 17.20	.529 13.44	.234 5.94	109452-5			
				10	.020 0.51	Pre-Tin Plated Brass	.296 7.52	.677 17.20	.529 13.44	.234 5.94	109452-6			
			.120-.170 3.05-4.32	2	.020 0.51	Tin Plated Brass	.296 7.52	.640 16.26	.494 12.55	.234 5.94	63750-1			
				6	.020 0.51	Tin Plated Brass	.296 7.52	.640 16.26	.494 12.55	.234 5.94	41330*			
				8	.020 0.51	Brass	.296 7.52	.640 16.26	.494 12.55	.234 5.94	41559*			
				8	.020 0.51	Tin Plated Brass	.296 7.52	.640 16.26	.494 12.55	.234 5.94	63678-2 †			
				8	.020 0.51	Tin Plated Brass	.296 7.52	.640 16.26	.494 12.55	.234 5.94	41332*			
				8	.020 0.51	Tin Plated Phos. Brz.	.296 7.52	.640 16.26	.494 12.55	.234 5.94	1217160-1			
	.085-.150 2.16-3.81	10	.020 0.51	Pre-Tin Plated Brass	10	.020 0.51	Brass	.296 7.52	.640 16.26	.494 12.55	.234 5.94	41560*		
					10	.020 0.51	Pre-Tin Plated Brass	.296 7.52	.640 16.26	.494 12.55	.234 5.94	63628-1 †		
					10	.020 0.51	Tin Plated Brass	.296 7.52	.640 16.26	.494 12.55	.234 5.94	41333*		
					1/4"	.025 0.51	Tin Plated Brass	.473 12.01	1.016 25.81	.780 19.81	.469 11.91	626034-2		
					8	.025 0.64	Tin Plated Brass	.342 8.69	.782 19.89	.612 15.55	.305 7.75	60024-2		
					10	.025 0.64	Tin Plated Brass	.342 8.69	.783 19.89	.612 15.55	.305 7.75	60433-2		
		.100-.140 2.54-3.56	1/4"	.025 0.64	Tin Plated Brass	1/4"	.025 0.64	Tin Plated Brass	.342 8.69	.783 19.89	.612 15.55	.305 7.75	60625-1	
						10	.025 0.64	Brass	.342 8.69	.789 20.04	.618 15.70	.305 7.75	60744-1	
						10	.025 0.64	Tin Plated Brass	.342 8.69	.789 20.04	.618 15.70	.305 7.75	60744-2	
			.120-.160 3.05-4.07	6	.018 0.46	Brass	6	.018 0.46	Brass	.295 7.49	.734 18.64	.586 14.88	.282 7.16	60770-1
							6	.018 0.46	Tin Plated Brass	.295 7.49	.734 18.64	.586 14.88	.282 7.16	60770-2
							8	.018 0.46	Brass	.295 7.49	.734 18.64	.586 14.88	.282 7.16	60771-1
8	.018 0.46	Tin Plated Brass		8	.018 0.46	Tin Plated Brass	.295 7.49	.734 18.64	.586 14.88	.282 7.16	60771-2			
				10	.018 0.46	Brass	.295 7.49	.734 18.64	.586 14.88	.282 7.16	60772-1			
				10	.018 0.46	Tin Plated Brass	.295 7.49	.734 18.64	.586 14.88	.282 7.16	60772-2			

\* Not recommended for 2 wire applications.

† Recommended for 2 wire applications.

**Note:** The part numbers listed are for use with existing machine models. For AMP-O-LECTRIC Model G applicators part numbers, call the Technical Support Center at 1-800-522-6752.

**Ring Tongue Terminals, Insulation Support** (Continued)

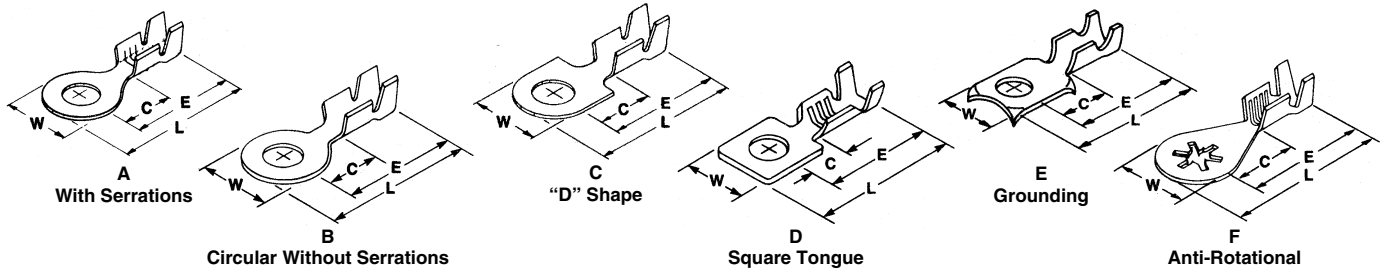

Ring Tongue Terminals

Type	Wire Range		Insul. Size	Stud Size/ Dia.	Stock Thk.	Material and Finish	Dimensions				Part Number
	AWG	mm <sup>2</sup>					W	L	E	C	
A	18-14	0.8-2.0	.100-.140 2.54-3.56	10	.018 0.46	Tin Plated Brass	.295 7.49	.734 18.64	.586 14.88	.282 7.16	60772-3
			.090-.145 2.29-3.68	1/2"	.025 0.64	Pre-Tin Plated Steel	.687 17.45	1.245 31.62	.908 23.06	.500 12.70	61777-1
			.140-.190 3.56-4.83	10	.030 0.76	Tin Plated Brass	.342 8.69	.784 19.91	.608 15.44	.305 7.75	61397-1
			.080-.150 2.03-3.81	1/4"	.030 0.76	Tin Plated Brass	.490 12.45	1.050 26.68	.810 20.57	.460 11.68	61867-2
E	18-14	0.8-2.0	.090-.140 2.29-3.56	5/16"	.030 0.76	Tin Plated Steel	.592 15.04	1.150 29.21	.930 23.62	.615 15.62	61359-1
F	18-14	0.8-2.0	.105-.145 2.67-3.68	8	.024 0.61	Stainless Steel	.370 9.40	.772 19.61	.587 14.91	.282 7.16	640051-1*
				5	.025 0.64	Tin Plated Steel	.370 9.40	.772 19.61	.587 14.91	.282 7.16	63640-1
				6	.025 0.64	Tin Plated Steel	.370 9.40	.772 19.61	.587 14.91	.282 7.16	61793-1
				8	.025 0.64	Tin Plated Steel	.370 9.40	.772 19.61	.587 14.91	.282 7.16	61794-1
				8	.025 0.64	Brass	.370 9.40	.772 19.61	.587 14.91	.282 7.16	61794-4
				10	.025 0.64	Tin Plated Steel	.445 11.30	.772 19.61	.587 14.91	.282 7.16	63482-1
			.105-.145 2.67-3.68	10	.024 0.61	Stainless Steel	.370 9.40	.772 19.61	.587 14.91	.282 7.16	640052-1*
				10	.025 0.64	Tin Plated Steel	.370 9.40	.772 19.61	.587 14.91	.282 7.16	350436-2
				10	.025 0.64	Tin Plated Steel	.445 11.30	.772 19.61	.587 14.91	.282 7.16	61795-1
				10	.025 0.64	Tin Plated Steel	.445 11.30	.772 19.61	.587 14.91	.282 7.16	61795-3
				12	.025 0.64	Tin Plated Brass	.687 17.45	1.245 31.62	.980 24.89	.495 12.57	63997-1
				1/4"	.025 0.64	Stainless Steel	.687 17.45	1.245 31.62	.908 23.06	.495 12.57	63602-1*
A	18-14	0.8-2.0	.090-.145 2.29-3.68	1/2"	.025 0.64	Stainless Steel	.687 17.45	1.245 31.62	.908 23.06	.495 12.57	62786-1*
			.100-.180 2.54-4.57	10	.030 0.76	Brass	.340 8.64	1.170 29.72	1.010 25.65	.660 16.76	62700-1
			.080-.150 2.03-3.81	1/2"	.030 0.76	Tin Plated Brass	.850 21.59	1.450 36.83	1.030 26.16	.680 17.27	61863-2
B	18-14	0.8-2.0	.090-.145 2.29-3.68	5/16"	.025 0.64	Stainless Steel	.687 17.45	1.245 31.62	.908 23.06	.495 12.57	62787-1*
D	18-14	0.8-2.0	.085-.140 2.16-3.56	8	.025 0.64	Tin Plated Phos. Brz.	.370 9.40	.835 21.21	.615 15.62	.250 6.35	62975-1
C	18-14	0.8-2.0	.085-.140 2.16-3.56	1/4"	.025 0.64	Tin Plated Brass	.470 11.94	.930 23.62	.705 17.91	.340 8.64	485029-1
			.085-.140 2.16-3.56	5/16"	.025 0.64	Tin Plated Brass	.470 11.94	.930 23.62	.705 17.91	.340 8.64	485030-1

\* Stainless steel wire connectors cannot be certified under the current CSA standard.

Note: The part numbers listed are for use with existing machine models. For AMP-O-LECTRIC Model G applicators part numbers, call the Technical Support Center at 1-800-522-6752.

**Ring Tongue Terminals, Insulation Support** (Continued)

Ring Tongue Terminals

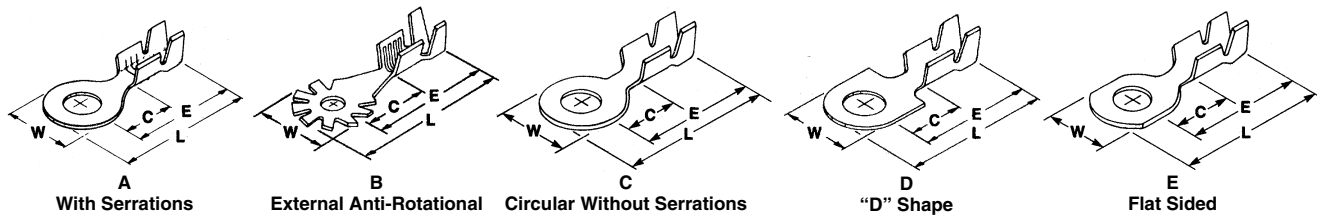

Type	Wire Range		Insul. Size	Stud Size/ Dia.	Stock Thk.	Material and Finish	Dimensions				Part Number
	AWG	mm <sup>2</sup>					W	L	E	C	
E	18-14	0.8-2.0	.100-.140 2.54-3.56	5	.020 0.51	Tin Plated Brass	.240 6.10	.833 21.16	.662 16.82	.312 7.93	63518-1
B	18-14	0.8-2.0	.085-.140 2.16-3.56	10	.025 0.64	Tin Plated Steel	.470 11.94	.940 23.88	.705 17.91	.340 8.64	350080-1
				10	.025 0.64	Brass	.470 11.94	.940 23.88	.705 17.91	.340 8.64	63707-1
A	18-14	0.8-2.0	.120-.175 3.05-4.45	10	.020 0.51	Pre-Ni Plated Steel	.342 8.69	.783 19.89	.612 15.55	.305 7.75	350199-1
H	18-14	0.8-2.0	.120-.170 3.05-4.32	6-10	.016 0.41	Pre-Tin Plated Brass	.300 7.62	.755 19.18	.595 15.11	.280 7.11	350981-2
A	18-14	0.8-2.0	.140-.190 3.56-4.83	8	.030 0.76	Tin Plated Brass	.342 8.69	.784 19.91	.608 15.44	.305 7.75	640102-1
				10	.030 0.76	Pre-Tin Plated Brass	.296 7.52	.676 17.17	.528 13.41	.234 5.94	109451-6
			.120-.170 3.05-4.32	10	.030 0.76	Brass	.470 11.94	1.046 26.57	.811 20.60	.384 9.75	42751-1
				10	.030 0.76	Tin Plated Brass	.470 11.94	1.046 26.57	.811 20.60	.384 9.75	42751-2
				10	.030 0.76	Phos. Bronze	.470 11.94	1.046 26.57	.811 20.60	.384 9.75	42751-3
				10	.030 0.76	Tin Plated Brass	.470 11.94	1.046 26.57	.811 20.60	.384 9.75	42938-2
				10	.030 0.76	Tin Plated Brass	.470 11.94	1.046 26.57	.811 20.60	.384 9.75	42752-2
				3/8"	.040 1.02	Tin Plated Brass	.687 17.45	1.245 31.62	.908 23.06	.495 12.57	61336-1
				10	.030 0.76	Tin Plated Brass	.687 17.45	1.245 31.62	.902 22.91	.495 12.57	1217330-1
				10	.020 0.51	Brass	.375 9.53	.873 22.17	.686 17.42	.312 7.93	41294
C	16-14	1.25-2.0	.120-.180 3.05-4.57	10	.030 0.76	Br. Tin Plated Brass	.375 9.53	.873 22.17	.686 17.42	.312 7.93	640007-1
				10	.030 0.76	Br. Tin Plated Brass	.470 11.94	1.046 26.57	.811 20.60	.384 9.75	640011-1
F	16-12	1.25-3.0	.130-.170 3.30-4.32	8	.025 0.64	Brass	.370 9.40	.772 19.61	.587 14.91	.282 7.16	61624-1
G	16-12	1.25-3.0	.130-.170 3.30-4.32	8	.025 0.64	Tin Plated Brass	.370 9.40	.772 19.61	.587 14.91	.282 7.16	63698-1
A	16-12	1.25-3.0	(2) .125 3.18	10	.018 0.46	Tin Plated Brass	.342 8.69	.784 19.91	.608 15.44	.305 7.75	640253-2
				10	.030 0.76	Tin Plated Brass	.425 10.80	.972 24.69	.750 19.05	.344 8.74	60485-1
			.130-.180 3.30-4.57	6	.040 1.02	Tin Plated Brass	.425 10.80	.972 24.69	.750 19.05	.344 8.74	40604-1
				8	.040 1.02	Tin Plated Brass	.425 10.80	.972 24.69	.750 19.05	.344 8.74	40605-1
				10	.040 1.02	Tin Plated Brass	.425 10.80	.972 24.69	.750 19.05	.344 8.74	40960
				10	.040 1.02	Tin Plated Brass	.425 10.80	.972 24.69	.750 19.05	.344 8.74	42639-1
				1/4"	.040 1.02	Brass	.425 10.80	.972 24.69	.750 19.05	.344 8.74	41604
				1/4"	.040 1.02	Tin Plated Brass	.425 10.80	.950 24.13	.728 18.49	.344 8.74	40973
D	14-12	2.0-3.0	.130-.180 3.30-4.57	1/4"	.040 1.02	Tin Plated Phos. Bronze	.425 10.80	.950 24.13	.728 18.49	.344 8.74	40973-1

**Note:** The part numbers listed are for use with existing machine models. For AMP-O-LECTRIC Model G applicators part numbers, call the Technical Support Center at 1-800-522-6752.

**Ring Tongue Terminals, Insulation Support** (Continued)

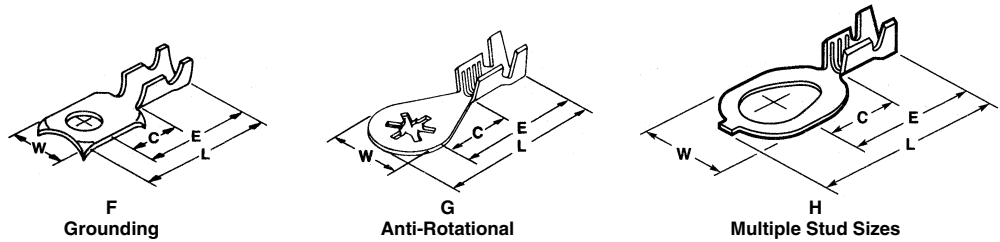

Type	Wire Range		Insul. Size	Stud Size/ Dia.	Stock Thk.	Material and Finish	Dimensions				Part Number	
	AWG	mm <sup>2</sup>					W	L	E	C		
C	12-10	3.0-6.0	.170-.210 4.32-5.33	6	.040 1.02	Tin Plated Brass	.343 8.71	.921 23.39	.750 19.05	.344 8.74	61424-1	
A	12-10	3.0-6.0	.150-.210 3.81-5.33	1/4"	.040 1.02	Tin Plated Copper	.535 13.59	1.045 26.54	.780 19.81	.406 10.31	61844-1	
G	12-10	3.0-6.0	.125-.220 3.18-5.59	8	.024 0.61	Stainless Steel	.470 11.94	.995 25.27	.770 19.56	.340 8.64	62612-1	
				8	.025 0.64	Tin Plated Steel	.470 11.94	.995 25.27	.770 19.56	.340 8.64	62612-2	
				10	.024 0.61	Tin Plated Copper	.470 11.94	.995 25.27	.770 19.56	.340 8.64	62613-3	
				10	.025 0.64	Tin Plated Steel	.470 11.94	.995 25.27	.770 19.56	.340 8.64	62613-2	
A	12-10	3.0-6.0	.150-2.10 3.81-5.33	10	.030 0.76	Br. Tin Plated Brass	.470 11.94	1.072 27.23	.839 21.31	.406 10.31	640009-1	
				10	.030 0.76	Tin Plated Brass	.470 11.94	1.072 27.23	.839 21.31	.406 10.31	41124	
					.257 6.53	Br. Tin Plated Brass	.470 11.94	1.072 27.23	.839 21.31	.406 10.31	640216-1	
					.257 6.53	Tin Plated Brass	.470 11.94	1.072 27.23	.839 21.31	.406 10.31	41125	
C	12-10	3.0-6.0	.150-.210 3.81-5.33	10	.030 0.76	Brass	.470 11.94	1.072 27.23	.839 21.31	.406 10.31	42722-1	
				8	.040 1.02	Tin Plated Brass	.343 8.71	.921 23.39	.750 19.05	.344 8.74	42863-2	
				10	.040 1.02	Brass	.343 8.71	.921 23.39	.750 19.05	.344 8.74	42864-1	
				10	.040 1.02	Tin Plated Brass	.343 8.71	.921 23.39	.750 19.05	.344 8.74	42864-2	
A	12-8	3.0-8.0	.150-.220 3.81-5.59	1/4"	.030 0.76	Tin Plated Brass	.470 11.94	1.072 27.23	.839 21.31	.406 10.31	62691-2	
					.344 8.74	.040 1.02	Tin Plated Brass	.687 17.45	1.245 31.62	.906 23.01	.495 12.57	42946-2
					.344 8.74	.040 1.02	Br. Tin Plated Brass	.687 17.45	1.245 31.62	.906 23.01	.495 12.57	640012-1
				3/8"	.040 1.02	Tin Plated Brass	.687 17.45	1.245 31.62	.908 23.06	.495 12.57	61289-1	
D	10-8	5.0-8.0	.220-.315 5.59-8.00	10	.050 1.27	Tin Plated Copper	.550 13.97	1.105 28.07	.830 21.08	.350 8.89	41808	
				1/4"	.050 1.27	Tin Plated Copper	.550 13.97	1.105 28.07	.830 21.08	.350 8.89	41809	
				10	.040 1.02	Br. Tin Plated Brass	.425 10.80	.962 24.43	.750 19.05	.344 8.74	640249-1	
D	10-6	5.0-15.0	.220-.315 5.59-8.00	10	.040 1.02	Tin Plated Brass	.550 13.97	1.105 28.07	.830 21.08	.350 8.89	61352-1	
				5/16"	.040 1.02	Tin Plated Brass	.550 13.97	1.105 28.07	.830 21.08	.350 8.89	42913-2	
A	10-6	5.0-15.0	.145-.290 3.68-7.37	10	.040 1.02	Tin Plated Brass	.375 9.53	.992 25.20	.810 20.57	.400 10.16	61866-1	
				1/4"	.040 1.02	Tin Plated Brass	.490 12.45	1.110 28.19	.870 22.10	.460 11.68	61868-1	
				1/4"	.040 1.02	Br. Tin Plated Brass	.490 12.45	1.110 28.19	.870 22.10	.460 11.68	61868-2	

**Note:** The part numbers listed are for use with existing machine models. For AMP-O-LECTRIC Model G applicators part numbers, call the Technical Support Center at 1-800-522-6752.

**Ring Tongue Terminals, Non-Insulation Support**

Ring Tongue Terminals

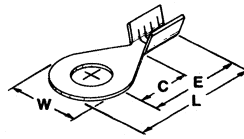

**A**  
With Serrations

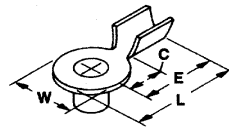

**B**  
Extruded

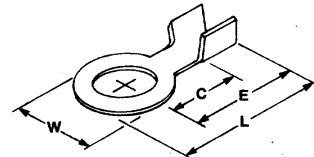

**C**  
Circular Tongue

Type	Wire Range		Stud Size/ Dia.	Stock Thk.	Material and Finish	Dimensions				Part Number
	AWG	mm <sup>2</sup>				W	L	E	C	
B	24-20	0.6-0.5	2	.012 0.30	Brass	.200 5.08	.350 8.89	.245 6.22	.130 3.30	61463-1
A	22-18	0.3-0.9	6	.020 0.51	Tin Plated Brass	.300 7.62	.485 12.32	.335 8.51	.230 5.84	62686-2
C	22-16	0.3-1.4	.125 3.18	.020 0.51	Tin Plated Brass	.250 6.35	.531 13.49	.406 10.31	.250 6.35	42185-2
			2	.020 0.51	Brass	.175 4.45	.360 9.14	.270 6.86	.125 3.18	40668
			.096 2.44	.020 0.51	Tin Plated Brass	.175 4.45	.360 9.14	.270 6.86	.125 3.18	40816
			.096 2.44	.020 0.51	Nickel Plated Steel	.175 4.45	.338 8.58	.250 6.35	.125 3.18	42204-1
			.096 2.44	.020 0.51	Tin Plated Brass	.234 5.94	.331 8.41	.234 5.94	.129 3.28	63457-1
			4	.020 0.51	Nickel Plated Steel	.175 4.45	.338 8.58	.250 6.35	.125 3.18	63676-1
			4	.020 0.51	Brass	.175 4.45	.360 9.14	.270 6.86	.125 3.18	40777
			4	.020 0.51	Tin Plated Brass	.260 6.60	.400 10.16	.270 6.86	.145 3.63	40810
A	20-16	0.5-1.4	5	.020 0.51	Brass	.234 5.94	.331 8.41	.234 5.94	.129 3.28	34578
			.130 3.30	.020 0.51	Tin Plated Brass	.234 5.94	.331 8.41	.234 5.94	.129 3.28	40884
			.131 3.33	.020 0.51	Tin Plated Brass	.260 6.60	.400 10.16	.270 6.86	.145 3.63	63243-1
			6	.020 0.51	Tin Plated Brass	.260 6.60	.400 10.16	.270 6.86	.145 3.63	40811
			6	.020 0.51	Tin Plated Steel	.260 6.60	.400 10.16	.270 6.86	.145 3.63	40811-1
			8	.020 0.51	Brass	.260 6.60	.400 10.16	.270 6.86	.145 3.63	40749
			8	.020 0.51	Tin Plated Brass	.260 6.60	.400 10.16	.270 6.86	.145 3.63	40812
			6	.030 0.76	Tin Plated Brass	.218 5.54	.432 10.97	.330 8.38	.167 4.24	40976
A	20-14	0.5-2.0	6	.020 0.51	Brass	.250 6.35	.395 10.03	.285 7.24	.160 4.07	40702
			.096 2.44	.020 0.51	Brass	.175 4.45	.360 9.14	.255 6.48	.125 3.18	41006
			.096 2.44	.020 0.51	Tin Plated Brass	.175 4.45	.360 9.14	.255 6.48	.125 3.18	41499
			6	.020 0.51	Brass	.300 7.62	.535 13.59	.380 9.65	.230 5.84	34848
			6	.020 0.51	Tin Plated Brass	.300 7.62	.535 13.59	.380 9.65	.230 5.84	40593
			6	.020 0.51	Pre-Ni Plated Steel	.300 7.62	.535 13.59	.385 9.78	.230 5.84	40979
A	18-14	0.8-2.0	8	.020 0.51	Brass	.300 7.62	.535 13.59	.380 9.65	.230 5.84	34812
			8	.020 0.51	Tin Plated Brass	.300 7.62	.535 13.59	.380 9.65	.230 5.84	40594
			8	.020 0.51	Pre-Ni Plated Steel	.300 7.62	.535 13.59	.385 9.78	.230 5.84	41346
			10	.020 0.51	Brass	.300 7.62	.535 13.59	.380 9.65	.230 5.84	34839
			10	.020 0.51	Tin Plated Brass	.300 7.62	.535 13.59	.380 9.65	.230 5.84	40595
			8	.030 0.76	Tin Plated Brass	.343 8.71	.611 15.52	.435 11.05	.275 6.99	40517

**Note:** The part numbers listed are for use with existing machine models. For AMP-O-LECTRIC Model G applicators part numbers, call the Technical Support Center at 1-800-522-6752.



**Ring Tongue Terminals, Non-Insulation Support** (Continued)

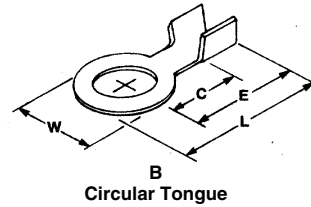
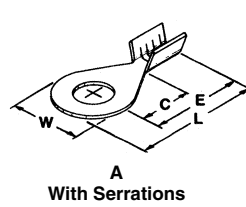

Ring Tongue Terminals

Type	Wire Range		Stud Size/ Dia.	Stock Thk.	Material and Finish	Dimensions				Part Number
	AWG	mm <sup>2</sup>				W	L	E	C	
B	18-14	0.8-2.0	5	.020 0.51	Tin Plated Brass	.234 5.94	.331 8.41	.234 5.94	.129 3.28	60250-2
			4	.025 0.64	Tin Plated Brass	.250 6.35	.460 11.68	.349 8.86	.160 4.07	42054-2
A	18-14	0.8-2.0	6	.025 0.64	Brass	.300 7.62	.570 14.48	.420 10.67	.230 5.84	42110-1
			6	.025 0.64	Tin Plated Brass	.300 7.62	.570 14.48	.420 10.67	.230 5.84	42111-1
			8	.025 0.64	Tin Plated Brass	.300 7.62	.570 14.48	.420 10.67	.230 5.84	42111-2
			10	.025 0.64	Brass	.300 7.62	.570 14.48	.420 10.67	.230 5.84	42110-3
			10	.025 0.64	Tin Plated Brass	.300 7.62	.570 14.48	.420 10.67	.230 5.84	42111-3
			10	.025 0.64	Stainless Steel	.300 7.62	.535 13.59	.385 9.78	.230 5.84	42716-2
			5	.030 0.76	Tin Plated Brass	.343 8.71	.611 15.52	.435 11.05	.275 6.99	60505-1
			10	.030 0.76	Brass	.343 8.71	.611 15.52	.435 11.05	.275 6.99	40796
			10	.030 0.76	Tin Plated Brass	.343 8.71	.611 15.52	.435 11.05	.275 6.99	40977
			B	18-14	0.8-2.0	6	.020 0.51	Tin Plated Brass	.281 7.14	.455 11.56
8	.020 0.51	Brass				.281 7.14	.455 11.56	.335 8.51	.210 5.33	40951
10	.030 0.76	Tin Plated Brass				.343 8.71	.677 17.20	.501 12.73	.281 7.14	40696
8	.040 1.02	Brass				.343 8.71	.677 17.20	.501 12.73	.281 7.14	42425-1
8	.040 1.02	Tin Plated Brass				.343 8.71	.677 17.20	.501 12.73	.281 7.14	40523
10	.040 1.02	Brass				.343 8.71	.677 17.20	.501 12.73	.281 7.14	41911
A	12-10	3.0-6.0	10	.040 1.02	Tin Plated Brass	.343 8.71	.677 17.20	.501 12.73	.281 7.14	40524
			10	.040 1.02	Tin Plated Copper	.343 8.71	.670 17.02	.500 12.70	.281 7.14	41090
			10	.040 1.02	Tin Plated Copper	.500 12.70	.820 20.83	.582 14.78	.338 8.58	42555-1
			1/4"	.040 1.02	Tin Plated Copper	.500 12.70	.820 20.83	.582 14.78	.338 8.58	41341
			1/4"	.040 1.02	Tin Plated Brass	.500 12.70	.820 20.83	.582 14.78	.338 8.58	41356
			5/16"	.040 1.02	Tin Plated Copper	.500 12.70	.820 20.83	.582 14.78	.338 8.58	42890-1

**Note:** The part numbers listed are for use with existing machine models. For AMP-O-LECTRIC Model G applicators part numbers, call the Technical Support Center at 1-800-522-6752.

**Ring Tongue Terminals, Non-Insulation Support** (Continued)

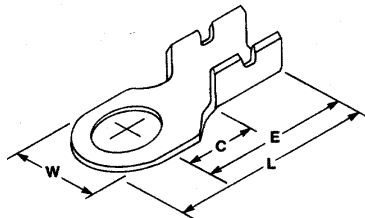

A  
"D" Shape

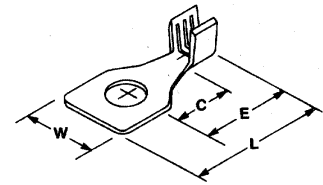

B  
Square

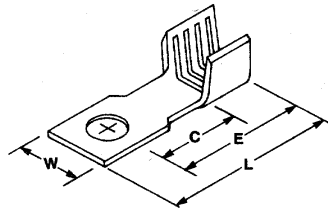

C  
Square

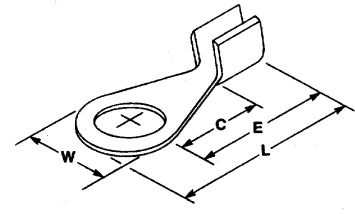

D  
Without Serrations

Type	Wire Range		Stud Size/ Dia.	Stock Thk.	Material and Finish	Dimensions				Part Number
	AWG	mm <sup>2</sup>				W	L	E	C	
C	12-10	3.0-6.0	6	.030 0.76	Tin Plated Brass	.240 6.10	.659 16.74	.500 12.70	.281 7.14	640257-1
B	10-8	5.0-8.0	10	.040 1.02	Tin Plated Brass	.385 9.78	.717 18.21	.547 13.89	.340 8.64	42673-2
					Brass	.550 13.97	1.105 28.07	.830 21.08	.500 12.70	485015-2
D	10-6	5.0-15.0	10	.050 1.27	Tin Plated Brass	.550 13.97	1.105 28.07	.830 21.08	.500 12.70	485015-1
					Tin Plated Brass	.550 13.97	1.105 28.07	.830 21.08	.500 12.70	61546-1
A	8 or 10	8.0 or 5.0	1/4"	.040 1.02	Brass	.428 10.87	.955 24.26	.743 18.87	.335 8.51	40797

**Note:** The part numbers listed are for use with existing machine models. For AMP-O-LECTRIC Model G applicators part numbers, call the Technical Support Center at 1-800-522-6752.

**Ring Tongue Terminals, Insulation Piercing**

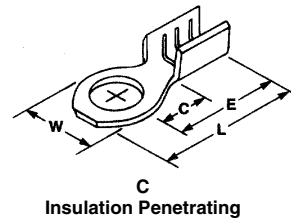
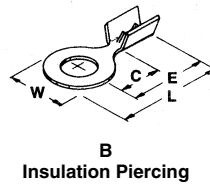
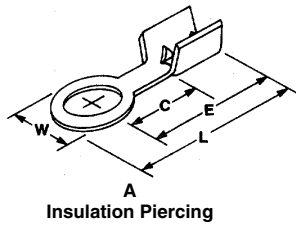

Type	Wire Range		Insul. Size	Stud Size/ Dia.	Stock Thk.	Material and Finish	Dimensions				Part Number
	AWG	mm <sup>2</sup>					W	L	E	C	
B	22-20	0.3-0.6	.050-.065 1.27-1.65	2	.013 0.33	Nickel Plated Brass	.165 4.19	.417 10.59	.300 7.62	.125 3.18	60422-3
					.013 0.33	Pre-Tin Plated Brass	.165 4.19	.417 10.59	.330 8.38	.125 3.18	41376
	5	.013 0.33	Tin Plated Brass	.186 4.72	.423 10.74	.335 8.51	.125 3.18	41409			
	20-16	0.3-1.4	.105-.120 2.67-3.05	6	.020 0.51	Brass	.300 7.62	.655 16.64	.505 12.83	.240 6.10	42023
C	Tinsel Wire		.030-.035 0.76-0.89	5	.014 0.36	Gold Plated Brass	.186 4.72	.440 11.18	.350 8.89	.130 3.30	61505-1 <sup>1</sup>
				5	.014 0.36	Tin Plated Brass	.186 4.72	.440 11.18	.350 8.89	.130 3.30	61505-2 <sup>1</sup>
				5	.014 0.36	Tin Plated Brass	.186 4.72	.440 11.18	.350 8.89	.130 3.30	640189-1 <sup>1</sup>
A	18-16	0.8-1.4	.110-.130 2.79-3.30	10	.016 0.41	Brass	.281 7.13	.800 20.32	.660 16.76	.350 8.89	61853-1

<sup>1</sup> Insulation penetrating.

**Note:** The part numbers listed are for use with existing machine models. For AMP-O-LECTRIC Model G applicators part numbers, call the Technical Support Center at 1-800-522-6752.

**Ring Tongue Terminals, Flag**

Ring Tongue Terminals

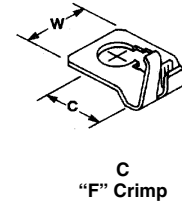
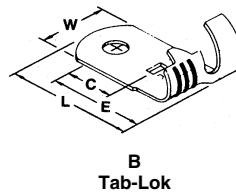
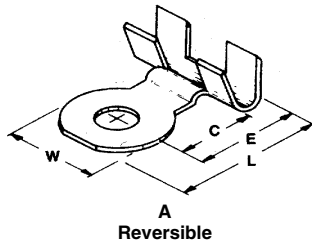

Type	Wire Range		Insul. Size	Stud Size/ Dia.	Stock Thk.	Material and Finish	Dimensions				Part Number
	AWG	mm <sup>2</sup>					W	L	E	C	
A	18-16	0.8-1.4	—	6	.020 0.51	Tin Plated Brass	.280 7.11	.496 12.60	.342 8.69	.220 5.59	41443
C	18-14	0.8-2.0	.100-.140 2.54-3.56	.176 4.47	.020 0.51	Tin Plated Brass	.380 9.65	—	—	.270 6.86	61443-1
							.376 9.55	.720 18.29	.532 13.51	.263 6.68	42189-1
B	18-12	0.8-3.0	.110-.210 2.79-5.33	.172 4.37	.018 0.46	Tin Plated Brass	.376 9.55	.720 18.29	.532 13.51	.263 6.68	42190-1
							.203 5.16	.018 0.46	Tin Plated Brass	.376 9.55	.720 18.29

**Note:** The part numbers listed are for use with existing machine models. For AMP-O-LECTRIC Model G applicators part numbers, call the Technical Support Center at 1-800-522-6752.

**AMPLIVAR Ring Tongue Terminals**

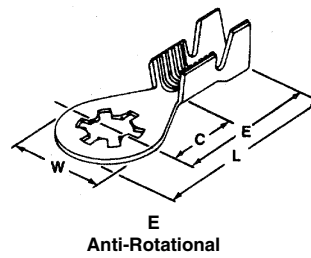
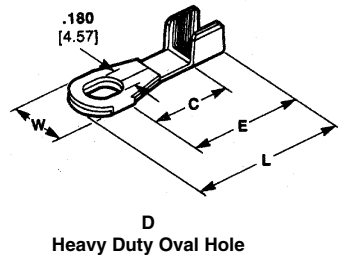
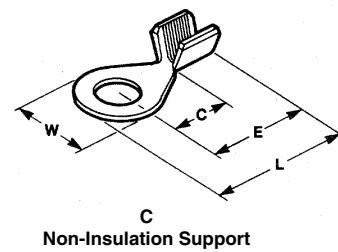
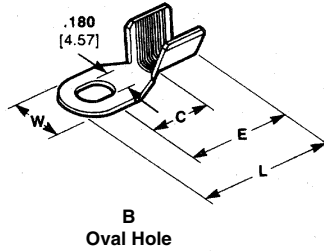
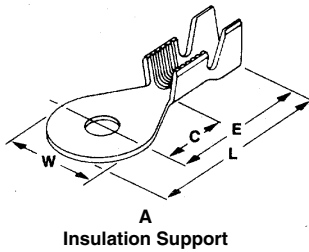

Type	Wire Range		Insul. Size	Hole Dia.	Stud Size/ Dia.	Stock Thk.	Material and Finish	Dimensions				Part Number
	AWG	mm <sup>2</sup>						W	L	E	C	
A	29-22	0.284-0.643	.040-.060	.197	10	.020	Tin Plated Brass	.342	.833	.662	.312	63399-1
			1.02-1.52	5.00	0.51	8.69	21.16	16.81	7.92	60321-2		
A	23-19	0.574-0.912	.100-.140	.171	8	.020	Tin Plated Brass	.342	.833	.662	.312	60321-2
			2.54-3.56	4.34	0.51	8.69	21.16	16.81	7.92	60323-2		
A	22-18	0.643-1.024	.125-.165	.171	8	.020	Tin Plated Brass	.300	.700	.550	.230	60323-2
			3.18-4.19	4.34	0.51	7.62	17.73	13.97	5.84	60319-2		
A	22-18	0.643-1.024	.100-.140	.197	10	.020	Tin Plated Brass	.342	.833	.662	.312	60319-2
			2.54-3.56	5.00	0.51	8.69	21.16	16.81	7.92	63612-1		
A	22-18	0.643-1.024	.125-.165	.265	1/4"	.025	Tin Plated Brass	.420	.872	.662	.312	63612-1
			3.18-4.19	6.73	0.64	10.67	22.15	16.81	7.92	63649-1		
C	22-18	0.643-1.024	—	—	6	.025	Tin Plated Brass	.290	.500	.355	.195	63649-1
			8	0.64	Brass	7.37	12.70	9.02	4.95	63446-1		
C	22-18	0.643-1.024	—	—	8	.025	Brass	.290	.500	.355	.195	63446-1
			8	0.64	Tin Plated Brass	7.37	12.70	9.02	4.95	63446-2		
C	22-18	0.643-1.024	—	—	8	.025	Tin Plated Brass	.290	.500	.355	.195	63446-2
			1/4"	0.64	Tin Plated Brass	10.67	17.83	12.50	7.92	62835-1		
A	20-16	0.183-1.29	.125-.165	.171	8	.020	Tin Plated Brass	.300	.695	.545	.230	60322-2
A	18-14	1.024-1.628	.100-.140	.171	8	.020	Brass	.342	.833	.662	.312	60320-1
			2.54-3.56	4.34	0.51	8.69	21.16	16.81	7.92	60320-2		
E	18-14	1.024-1.628	.080-.120	.173	8	.028	Lu-Bronze	.370	.915	.730	.380	485079-1 <sup>1</sup>
			2.03-3.05	4.39	0.71	9.40	23.24	18.54	9.65	485044-1 <sup>1</sup>		
E	18-14	1.024-1.628	.185	.185	8	.028	Lu-Bronze	.365	.882	.700	.380	485044-1 <sup>1</sup>
			4.70	4.70	0.71	9.27	22.40	17.78	9.65	485044-1 <sup>1</sup>		
D	14-12	1.628-2.05	—	.180	8	.025	Brass	.342	.833	.657	.312	62755-1
A	13-11	1.83-2.3	.085-.150	.180	8	.025	Brass	.342	.833	.657	.312	61710-1
			2.16-3.81	4.57	0.64	8.69	21.16	16.69	7.92	61710-1		
C	13-11	1.83-2.3	—	.180	8	.025	Tin Plated Brass	.342	.665	.495	.312	350571-1
			—	.197	10	.025	Tin Plated Brass	.342	.665	.495	.312	640212-1
A	(2) 17 or (2) 15	1.15 or 1.45	.150-.190	.171	8	.025	Tin Plated Brass	.342	.827	.656	.312	60752-2
			3.68-4.83	4.34	0.64	8.69	21.01	16.66	7.92	60752-2		
B	17-13 1/2	1.51-1.78	—	.180	8	.020	Brass	.310	.692	.492	.312	63147-1
				4.57	8	0.51	Brass	7.87	17.58	12.50	7.92	63147-1

<sup>1</sup>High conductivity copper-tin-zinc alloy.

**Note:** The part numbers listed are for use with existing machine models. For AMP-O-LECTRIC Model G applicators part numbers, call the Technical Support Center at 1-800-522-6752.

**Spade Tongue Terminals, Insulation Support**

Spade Tongue Terminals

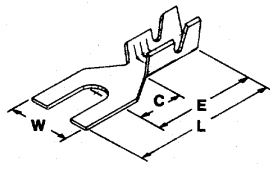

**A**  
With Serrations

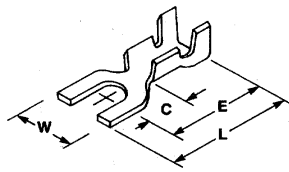

**B**  
Without Serrations

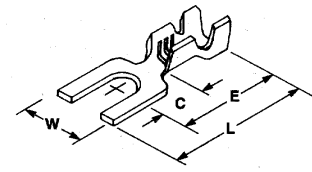

**C**  
With Serrations

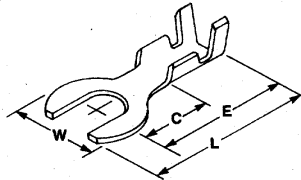

**D**  
Round Tongue

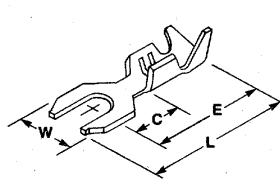

**E**  
Wrap Around Ins. Support

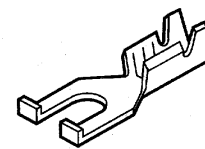

Flanged †

Type	Wire Range		Insul. Size	Stud Size/ Dia.	Stock Thk.	Material and Finish	Dimensions				Part Number
	AWG	mm <sup>2</sup>					W	L	E	C	
E	28-22	0.08-0.4	.035-.045 0.89-1.14	5	.016 0.41	Tin Plated Brass	.240 6.10	.545 13.84	.435 11.05	.215 5.46	350502-1
			.035-.045 0.89-1.14	5	.016 0.41	Brass	.240 6.10	.545 13.84	.435 11.05	.215 5.46	350502-2
A	26-20	0.12-0.6	.048-.078 1.22-1.98	6	.020 0.51	Tin Plated Brass	.250 6.35	.563 14.30	.422 10.72	.215 5.46	60124-2
			.048-.078 1.22-1.98	.185 4.70	.020 0.51	Tin Plated Brass	.295 7.49	.585 14.60	.443 11.25	.236 5.99	63374-1
A	24-20	0.2-0.6	.048-.078 1.22-1.98	6	.014 0.36	Tin Plated Brass	.250 6.35	.590 14.99	.442 11.23	.215 5.46	60445-2
			.048-.078 1.22-1.98	10	.014 0.36	Tin Plated Brass	.300 7.62	.590 14.99	.442 11.23	.215 5.46	60501-1
			.048-.078 1.22-1.98	.115 2.92	.020 0.51	Brass	.187 4.75	.517 13.13	.392 9.96	.185 4.70	42160-1
			.048-.078 1.22-1.98	.115 2.92	.020 0.51	Tin Plated Brass	.187 4.75	.517 13.13	.392 9.96	.185 4.70	42160-2
			.080-.100 2.03-2.54	8	.020 0.51	Tin Plated Brass	.290 7.37	.621 15.77	.470 11.94	.220 5.59	41589
			.080-.100 2.03-2.54	10	.020 0.51	Tin Plated Brass	.290 7.37	.621 15.77	.470 11.94	.220 5.59	41590
D	24-20	0.2-0.6	.075-.100 1.91-2.54	4	.020 0.51	Tin Plated Brass	.250 6.35	.535 13.59	.442 11.23	.218 5.54	61238-1
A	20-16	0.5-1.4	.090-.130 2.29-3.30	6	.020 0.51	Tin Plated Brass	.275 6.98	.657 16.69	.465 11.81	.175 4.44	40763
			.090-.130 2.29-3.30	8	.020 0.51	Tin Plated Brass	.275 6.98	.657 16.69	.465 11.81	.175 4.44	41343
C	20-16	0.5-1.4	.100-.140 2.54-3.56	6	.020 0.51	Brass	.280 7.11	.755 19.18	.525 13.33	.225 5.71	60389-1
			.100-.140 2.54-3.56	8	.020 0.51	Brass	.280 7.11	.755 19.18	.525 13.33	.225 5.71	60390-1
B	18-14	0.8-2.0	.130-.180 3.30-4.57	8	.025 0.64	Tin Plated Brass	.312 7.92	.645 16.38	.520 13.21	.209 5.31	60251-2
			.100-.140 2.54-3.56	10	.030 0.76	Tin Plated Brass	.343 8.71	.752 19.10	.612 15.54	.312 7.92	40808
A	18-14	0.8-2.0	.130-.180 3.30-4.57	6	.020 0.51	Tin Plated Brass	.275 6.98	.657 16.69	.463 11.76	.175 4.44	60725-1
			.130-.180 3.30-4.57	6	.018 0.46	Tin Plated Brass	.296 7.52	.750 19.05	.540 13.72	.235 5.97	60773-2
			.100-.140 2.54-3.56	8	.018 0.46	Brass	.296 7.52	.750 19.05	.540 13.72	.235 5.97	60774-1
			.100-.140 2.54-3.56	8	.018 0.46	Tin Plated Brass	.296 7.52	.750 19.05	.540 13.72	.235 5.97	60774-2
			.100-.140 2.54-3.56	10	.018 0.46	Brass	.296 7.52	.750 19.05	.540 13.72	.235 5.97	60775-1
			.100-.140 2.54-3.56	10	.018 0.46	Brass	.296 7.52	.750 19.05	.540 13.72	.235 5.97	60775-1

† Terminals flangable by designated applicator.

**Note:** The part numbers listed are for use with existing machine models. For AMP-O-LECTRIC Model G applicators part numbers, call the Technical Support Center at 1-800-522-6752.

**Spade Tongue Terminals, Insulation Support** (Continued)

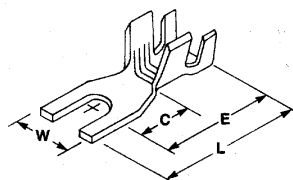

**A**  
Insulation Support

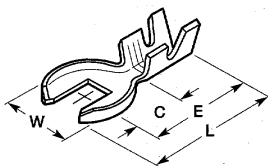

**B**  
Heavy Duty

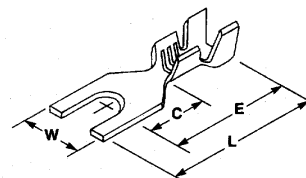

**C**  
Insulation Support

Type	Wire Range		Insul. Size	Stud Size/ Dia.	Stock Thk.	Material and Finish	Dimensions				Part Number
	AWG	mm <sup>2</sup>					W	L	E	C	
B	18-14	0.8-2.0	.120-.180 3.05-4.57	.205 × .291 5.21 × 7.39	.030 0.76	Tin Plated Copper	.490	.800	.613	.333	60998-1
							12.45	20.32	15.57	8.46	
C	18-14	0.8-2.0	.080-.150 2.03-3.81	10	.025 0.64	Tin Plated Brass	.375	.930	.750	.400	61857-2
							9.53	23.62	19.05	10.16	
A	10-6	5.0-15.0	.145-.290 3.68-7.37	10	.040 1.02	Tin Plated Brass	.375	1.015	.810	.400	61855-1
							9.52	25.78	20.57	10.16	

<sup>1</sup> Tongue Bent 45°.

**Note:** The part numbers listed are for use with existing machine models. For AMP-O-LECTRIC Model G applicators part numbers, call the Technical Support Center at 1-800-522-6752.

**Spring Spade**

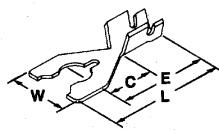

**A**  
Insulation Support

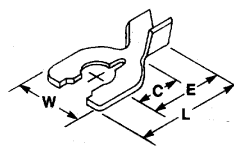

**B**  
Non-Insulation Support

Type	Wire Range		Insul. Size	Stud Size/ Dia.	Stock Thk.	Material and Finish	Dimensions				Part Number	
	AWG	mm <sup>2</sup>					W	L	E	C		
A	18-14	0.8-2.0	.100-.140 2.54-3.56	6	.030 0.76	Tin Plated Brass	.250	.690	.550	.243	63268-1	
							6.35	17.53	13.97	6.17		
							.343	.752	.612	.312		60187-2
							8.71	19.10	15.54	7.92		
.343	.752	.612	.312	42168-2								
8.71	19.10	15.54	7.92									
A	16-12	1.4-3.0	.110-.150 2.79-3.81	8	.030 0.76	Tin Plated Brass	.343	.745	.612	.312	62795-1	
							8.71	18.92	15.54	7.92		
B	20-16	0.5-1.4	—	.138 3.51	.020 0.51	Tin Plated Brass	.260	.472	.350	.194	485073-1	
							6.60	11.99	8.89	4.93		
							B	18-14	0.8-2.0	—		8
8.00	14.07	9.88	6.33									
B	14-10	2.0-5.0	—	10	.040 1.02	Brass Tin Plated Brass	.372	.668	.506	.281	63610-1 63610-2	
							9.45	16.97	12.85	7.14		

**Note:** The part numbers listed are for use with existing machine models. For AMP-O-LECTRIC Model G applicators part numbers, call the Technical Support Center at 1-800-522-6752.

**Spade Tongue Terminals, Non-Insulation Support**

Spade Tongue Terminals

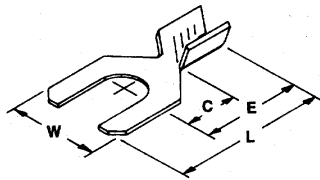

**A**  
With Serrations

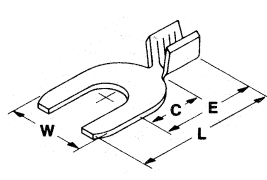

**B**  
With Serrations

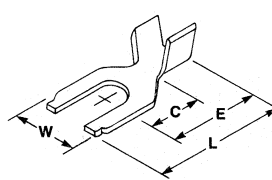

**C**  
Without Serrations

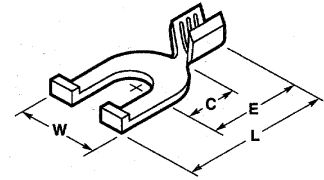

**D**  
Flanged

Type	Wire Range		Insul. Size	Stud Size/ Dia.	Stock Thk.	Material and Finish	Dimensions				Part Number
	AWG	mm <sup>2</sup>					W	L	E	C	
D	20-16	0.5-1.4	—	6	.020 0.51	Tin Plated Brass	.275 6.99	.527 13.39	.328 8.33	.175 4.45	42318-2
B	18-14	0.8-2.0	—	10	.030 0.76	Tin Plated Brass	.343 8.71	.628 15.95	.441 11.20	.275 6.99	40521
A	18-14	0.8-2.0	—	6	.025 0.64	Brass	.275 6.99	.482 12.24	.295 7.49	.175 4.45	40577
C	18-14	0.8-2.0	—	8	.025 0.64	Brass	.275 6.99	.482 12.24	.295 7.49	.175 4.45	40705
				8	.025 0.64	Tin Plated Brass	.275 6.99	.482 12.24	.295 7.49	.175 4.45	41473
B	12-10	3.0-6.0	—	8	.030 0.76	Tin Plated Brass	.312 7.92	.688 17.48	.450 11.43	.235 5.97	42113-2
				10	.030 0.76	Brass	.312 7.92	.688 17.48	.450 11.43	.235 5.97	40891
D	12-10	3.0-6.0	—	10	.030 0.76	Tin Plated Brass	.312 7.92	.688 17.48	.450 11.43	.235 5.97	41495
				10	.040 1.02	Brass	.440 11.18	.968 24.58	.700 17.78	.435 11.05	63526-1

**Note:** The part numbers listed are for use with existing machine models. For AMP-O-LECTRIC Model G applicators part numbers, call the Technical Support Center at 1-800-522-6752.

**Spade Hook Terminals**

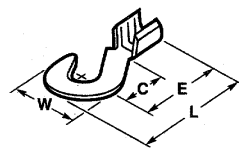

**E**  
With Serrations

Type	Wire Range		Insul. Size	Stud Size/ Dia.	Stock Thk.	Material and Finish	Dimensions				Part Number
	AWG	mm <sup>2</sup>					W	L	E	C	
E	18-14	0.8-2.0	—	10	.020 0.51	Tin Plated Brass	.280 7.11	.540 13.72	.374 9.50	.214 5.44	41461

**Note:** The part numbers listed are for use with existing machine models. For AMP-O-LECTRIC Model G applicators part numbers, call the Technical Support Center at 1-800-522-6752.



**Spade Tongue Terminals**

**Spade Insulation Piercing**

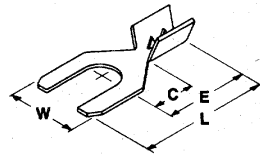

**A**  
Insulation Piercing

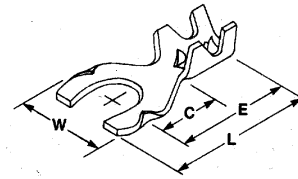

**B**  
SPADE-LOK

Type	Wire Range		Insul. Size	Stud Size/ Dia.	Stock Thk.	Material and Finish	Dimensions				Part Number	
	AWG	mm <sup>2</sup>					W	L	E	C		
A	28-22	0.08-0.4	.035-.040 0.89-1.02	5	.016 0.41	Brass	.250 6.35	.578 14.68	.422 10.72	.215 5.46	61498-1	
				5	.016 0.41	Tin Plated Brass	.250 6.35	.578 14.68	.422 10.72	.215 5.46	61498-2	
				5	.016 0.41	Pre-Tin Plated Brass	.250 6.35	.578 14.68	.422 10.72	.215 5.46	61498-3	
	26-22	0.12-0.4	.045-.050 1.14-1.27	5	.016 0.41	Brass	.250 6.35	.578 14.68	.472 11.99	.265 6.73	61519-1	
				5	.016 0.41	Tin Plated Brass	.250 6.35	.578 14.68	.422 10.72	.215 5.46	60234-2	
				5	.016 0.41	Tin Plated Brass	.250 6.35	.578 14.68	.422 10.72	.215 5.46	640260-2	
				6	.016 0.41	Tin Plated Brass	.250 6.35	.547 13.89	.422 10.72	.215 5.46	61385-2	
	B	20-16	0.5-1.4	.085-.105 2.16-2.67	5	.020 0.51	Tin Plated Brass	.250 6.35	.500 12.70	.392 9.96	.187 4.75	41933
					6	.020 0.51	Tin Plated Brass	.322 8.18	.750 19.05	.545 13.84	.281 7.14	40764
					8	.020 0.51	Tin Plated Brass	.322 8.18	.750 19.05	.545 13.84	.281 7.14	40765
10					.020 0.51	Tin Plated Brass	.322 8.18	.750 19.05	.545 13.84	.281 7.14	40766	
A	20-18	0.5-0.8	.065-.080 1.65-2.03	5	.020 0.51	Tin Plated Brass	.250 6.35	.542 14.77	.412 10.46	.206 5.23	42339-2	

**Note:** The part numbers listed are for use with existing machine models. For AMP-O-LECTRIC Model G applicators part numbers, call the Technical Support Center at 1-800-522-6752.

**Flag Spade and Spring Spade**

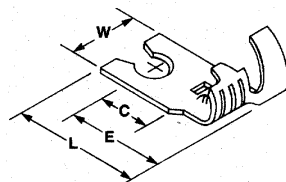

**A**  
Tab-Lok Spring Spade

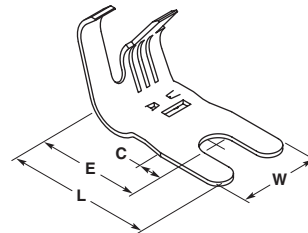

**B**  
Tab-Lok

Type	Wire Range		Insul. Size	Stud Size/ Dia.	Stock Thk.	Material and Finish	Dimensions				Part Number
	AWG	mm <sup>2</sup>					W	L	E	C	
A	18-12	0.8-3.0	.110-.210 2.79-5.33	12	.018 0.46	Brass	.315 8.00	.720 12.29	.535 13.59	.263 6.68	63053-1
B	18-12	0.8-3.0	.110-.210 2.79-5.33	8	.018 0.46	Tin Plated Brass	.376 9.55	.720 12.29	.535 13.59	.263 6.68	42187-11
				10	.018 0.46	Tin Plated Brass	.376 9.55	.720 12.29	.535 13.59	.263 6.68	42188-11

<sup>1</sup> Terminals may be bent 45° in applicator (use suffix "N").

**Note:** The part numbers listed are for use with existing machine models. For AMP-O-LECTRIC Model G applicators part numbers, call the Technical Support Center at 1-800-522-6752.

## Splices

### Product Facts

- Terminates stranded wire and/or solid wire combinations together or to leads on components or devices
- End feed splices available for pigtail connections.
- Side feed splices available for parallel connections.
- Available in brass, copper-nickel, phosphor bronze and steel material
- Precision formed, strip-fed splices terminated in AMP automatic machines for high production rates per hour



Tyco Electronics offers a full selection of AMP open barrel splices that are specifically designed to terminate combinations of stranded wire and/or solid wire to themselves or to resistors, light emitting devices (LED), glass reed switch assemblies, etc.

Open barrel splices are available with or without serrations. Pre-stripped stranded or solid wire leads are forced into the serrations during the crimping process. The resulting termination produces a high tensile strength connection that is resistant to corrosion. Depending on your specific application, open barrel splices are available for terminations in the 400 to 30,000 CMA range in brass, copper-nickel, phosphor bronze and steel material.

Others are available with insulation support barrels to terminate round or square posts, resistance wire, and solid pin or calrod leads. The insulation support barrel prevents harmful flexing of the wire at the termination point where the wire is rigidly crimped in the wire barrel and deters fraying of the insulation. Depending on your specific application, open barrel insulation support splices are available for terminations in the 150 to 12,000 CMA range in brass and steel material.

Insulation piercing splices are also available to eliminate the need to pre-strip the insulated wire. The barrel contains two perpendicular lances that are driven through the wire insulation to make contact with the conductor.

Depending on your specific application, open barrel insulation piercing splices are available for terminations in the 16–22 AWG wire range in brass material.

Identification splices are available for wire marking. Up to three digits can be stamped on the bands during the crimping process. Depending on your specific application, open barrel identification splices are available for terminations from .150 to .300 insulation diameters in brass and aluminum material.

Open barrel splices are manufactured in strip form and supplied on reels for semi-automated and fully automated terminations on crimping machines for high output per hour production rates.

### Technical Documents

Application Specifications describe requirements for using the product in its intended application and/or crimping information. They are intended for the Packaging and Design Engineer and the Machine Setup Person.

114-2088 — Pigtail and Thru Splices

**Splices** (Continued)

**Side Feed Splices —  
Non-Insulation Support**

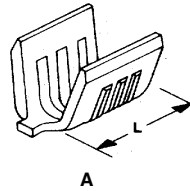

Type	Wire Range		Stock Thickness	Crimp Width	Dim. L	Material	Part Number
	CMA	mm <sup>2</sup>					
A	400-1300	0.20-0.66	.016 0.41	.070 1.78	.100 2.54	Brass	62759-1
						Tin Plated Brass	62759-2
						Steel	62759-5
	500-2200	0.25-1.11	.030 0.76	.110 2.79	.100 2.54	Brass	485016-1
						Brass	61769-1
	1200-2600	0.61-1.32	.020 0.51	.090 2.29	.120 3.05	Nickel Plated Steel	61769-2
						Brass	60372-1
						Brass	63130-2
	1500-5000	0.76-2.53	.020 0.51	.110 2.79	.155 3.94	Tin Plated Brass	63130-3
						Tin Plated Phos. Bz.	63130-4
						Brass	485043-1
	4000-9000	2.03-4.56	.020 0.51	.140 3.56	.250 6.35	Tin Plated Brass	485043-2
						Nickel Plated Steel	485043-4
						Tin Plated Steel	61299-1
	7000-12500	3.55-6.33	.031 0.79	.180 4.57	.265 6.73	Tin Plated Brass	61299-2
						Brass	61299-3
Brass						1217967-1	
8500-14000	4.31-7.10	.025 0.64	.180 4.57	.265 6.73	Tin Plated Brass	1217967-2	
					Brass	62754-1	
14000-30000	7.10-15.20	.030 0.76	.280 7.11	.310 7.87	Brass	62754-1	
					Tin Plated Brass	62754-2	

Splices

**Splices** (Continued)

**End Feed Splices —  
Non-Insulation Support**

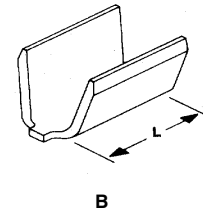
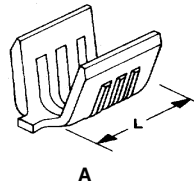

Type	Wire Range		Stock Thickness	Crimp Width	Dim. L	Material	Part Number
	CMA	mm <sup>2</sup>					
A	400-1100	0.20-0.56	.010 0.25	.055 1.40	.100 2.54	Brass	63834-1
	1000-3200	0.51-1.62	.020 0.51	.110 2.79	.150 3.81	Brass	41974
						Tin Plated Brass	41975
	1500-4600	0.76-2.33	.020 0.51	.110 2.79	.225 5.72	Nickel Plated Steel	62318-1
	2500-4700	1.27-2.38	.020 0.51	.120 3.05	.150 3.81	Brass	61492-1
						Tin/Cu Plated Brass	61492-2
						Copper-Nickel	61492-3
						Tin Plated Brass	40868
	3300-9000	1.67-4.56	.020 0.51	.140 3.56	.150 3.81	Brass	40509
						Tin Plated Brass	40552
						Nickel Plated Steel	40952
	B	800-2600	0.41-1.32	.016 0.41	.090 2.29	.065 1.65	Brass
Copper-Nickel							41459-1
1400-3600		0.71-1.82	.016 0.41	.090 2.29	.065 1.65	Tin Plated Brass	40862
						Tin Plated Steel	61008-1
1400-2800		0.71-1.42	.016 0.41	.090 2.29	.100 2.54	Tin Plated Steel	61008-1
2200-4200		1.11-2.13	.012 0.31	.090 2.29	.250 6.35	Nickel Plated Steel	63432-1
2200-2900		1.11-1.47	.012 0.31	.090 2.29	.065 1.65	Tin Plated Steel	60933-2
2200-4500		1.11-2.28	.012 0.31	.090 2.29	.065 1.65	Nickel Plated Steel	41215
2500-4700		1.27-2.38	.020 0.51	.120 3.05	.150 3.81	Nickel Plated Steel	41397
						Tin Plated Steel	60932-2
3200-3900		1.62-1.98	.012 0.31	.100 2.54	.150 3.81	Brass	60932-4
						Nickel Plated Steel	42329-1
3200-8000	1.62-4.05	.020 0.51	.140 3.56	.225 5.72	Brass	155352-1	
4000-10000	2.02-5.07	.025 0.64	.155 3.94	.250 6.35	Stainless Steel	41627-1	
6000-8000	3.04-4.05	.020 0.51	.155 3.94	.125 3.17	Tin Plated Steel	485020-1	
7000-13000	3.55-6.59	.025 0.64	.180 4.57	.225 5.72	Brass	155353-1	
					Tin Plated Brass	155353-2	
7400-10000	3.75-5.07	.025 0.64	.180 4.57	.250 6.35	Tin Plated Brass	41996	
					Brass	62357-1	
12000-18000	6.08-9.12	.025 0.64	.180 4.57	.250 6.35	Brass	60997-1	
					Nickel Plated Steel	60997-3	
					Stainless Steel	60997-5	

Splices

**Splices** (Continued)

**Insulation Support Splices**

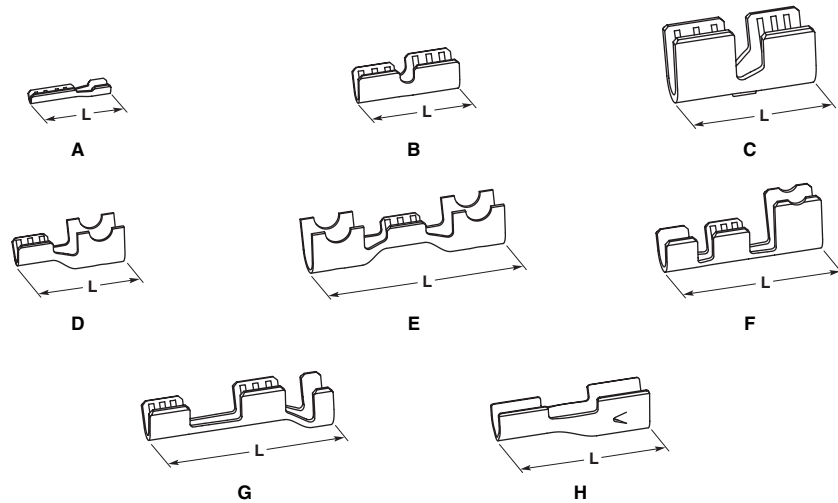

Type	Wire Range**		Insul. Dia.	Stock Thickness	Dim. L	Material	Part Number
	CMA	mm <sup>2</sup>					
A	150-480	0.76-2.43	.035-.050 0.89-1.27	.010 0.25	.305 7.75	Brass Tin Plated Brass	62382-1 62382-2
	250-500	0.13-0.25	—	.010 0.25	.190 4.83	Brass	1375622-11
B	975-2700	0.49-1.37	.080-.115 2.03-2.92	.012 0.31	.375 9.52	Nickel Plated Steel	61021-1
	1200-2200	0.61-1.11	.070-.100 1.78-2.54	.020 0.51	.230 5.84	Nickel Plated Steel	62503-2
	3200-9000	1.62-4.56	.120-.160 3.05-4.06	.020 0.51	.370 9.40	Nickel Plated Steel	42627-4
C	6000-12000	3.04-6.08	.140-.185 3.55-4.70	.031 0.79	.545 13.85	Tin Plated Steel	61300-1
D	1600-4100	0.81-2.08	.105-.145 2.67-3.68	.012 0.31	.450 11.43	Brass	60806-1
E	1600-4100	0.81-2.08	.105-.145 2.67-3.68	.012 0.31	.745 18.92	Brass	62516-2
F	975-3100	0.49-1.57	.080-.115 2.03-2.92	.020 0.51	.605 15.37	Tin Plated Steel	505033-12
G	a ~ 1000-3100	a ~ 0.51-1.57	.135-.170 3.43-4.32	.020 0.51	.705 17.90	Brass	62419-2
	b ~ 1500-4500	b ~ 0.76-2.28				Nickel Plated Steel	62419-3
H	1600-3000	0.81-1.52	.105-.145 2.67-3.68	.014 0.36	.580 14.70	Tin Plated Brass	1438246-2
	4100-6900	2.08-3.50				Brass	1438246-4
						Brass	1438246-5

\*\* Wire sizes indicated do not apply to resistance (heater) wire applications.  
1 Crimps to .015 [0.38] round or square post.  
2 Crimps to .092 [2.33] dia. solid pin or calrod.

**Insulation Piercing Crimp  
(AWG Wire, 7 Strands Min.)**



Type	Wire Range		Insul. Dia.	Stock Thickness	Dim. L	Material	Part Number
	CMA	mm <sup>2</sup>					
A	20-16	0.5-1.4	.070-.090 1.78-2.29	.020 0.51	.210 5.33	Tin Plated Brass	40771
B	22	0.3-0.4	.050-.065 1.27-1.65	.012 0.31	.210 5.33	Brass	485064-1
						Gold Plated Brass	485064-2
						Nickel Plated Brass	485064-4

**Splices** (Continued)

**Identification Bands \*\***

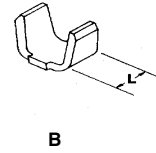
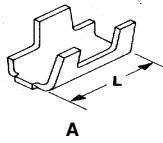

Type	Wire Range		Insul. Dia.	Stock Thickness	Dim. L	Material	Part Number
	AWG	mm <sup>2</sup>					
A	—	—	<b>.190-.220</b>	<b>.020</b>	<b>.250</b>	Aluminum	41276
			4.82-5.59			0.51	6.35
	—	—	<b>.210-.235</b>	<b>.020</b>	<b>.300</b>	Aluminum	1438254-1
			5.33-5.97			0.51	7.62
	—	—	<b>.240-.260</b>	<b>.030</b>	<b>.180</b>	Aluminum	1438254-2
			6.09-6.60			0.76	4.57

\*\* One to three digits can be stamped on bands in crimping operation.

## RTM Crimband Splices

### Product Facts

- Made from a continuous coil of "Ribbon Connector" material
- RTM Crimband have grooved serrations for improved axial retention
- Available in brass, tin-plated brass and copper-nickel alloy (CA725) material
- Make parallel or pigtail connections on same machine
- Used for electrical and non-electrical connections
- 100% of RTM Crimband material is used in scrap free terminations
- Crimband material coupled with appropriate toolsets accommodate specific CMA ranges
- Produced in Tyco Electronics equipment on your production floor
- Meets UL 486C crimp tensile requirements

### Applications

- Stranded and solid wire-to-wire connections
- Light bulb LED assembly
- Switch lead assembly
- Resistor lead assembly
- Printed circuit board lead assembly
- Flex-film lead assembly
- Glass reed switch lead assembly

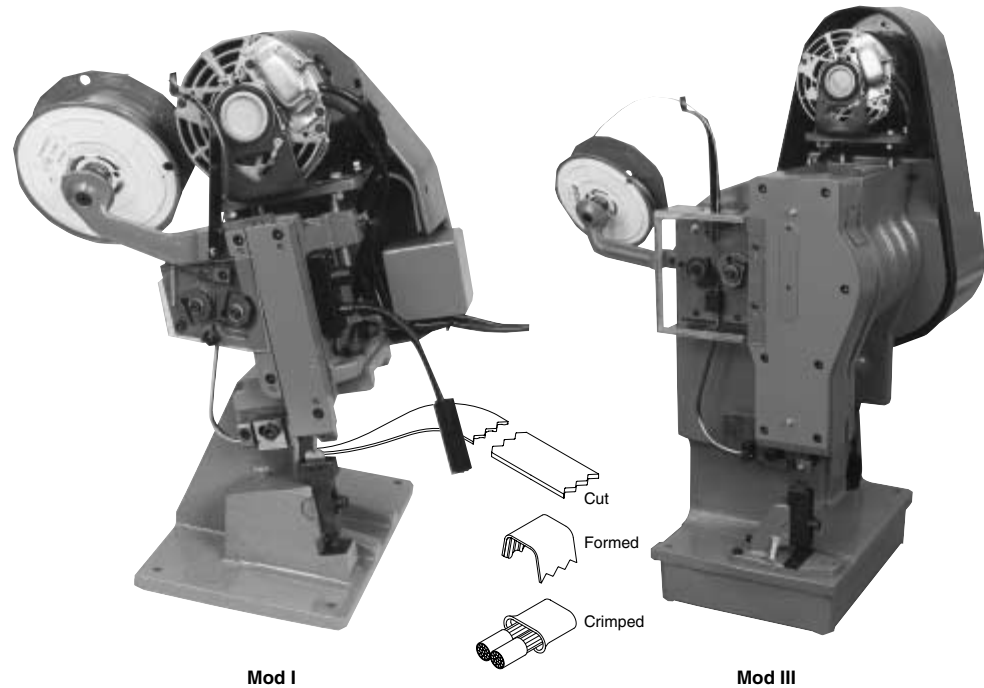

Mod I

Mod III

Tyco Electronics features the AMP RTM Crimband system that is comprised of two key features: the semi-automatic termination machine and a reel of RTM Crimband material.

In a one-step crimping operation, the machine feeds, cuts, forms and crimps the material to provide a low-cost, high reliability crimp connection.

The RTM Crimband splices are formed during the crimping process from

milled longitudinal groove material that produce rolled, rounded serrations.

They are designed to terminate pre-stripped stranded and solid wire conductors together as well as wire conductors to switch tabs, resistors, printed circuit board, flex circuit and light bulb LED and glass reed switch assemblies, etc.

The flexibility of the RTM Crimband system provides opportunity for use in custom applications for

either electrical and / or mechanical connections.

Tyco Electronics provides a wide range of toolset types and crimband splices to meet various production requirements.

Depending on your specific application, RTM Crimband splices are available in 3, 6, 7, 8, 9, 10 14 and 20 ridge serration versions for terminations in the 170 to 13,000 CMA range.

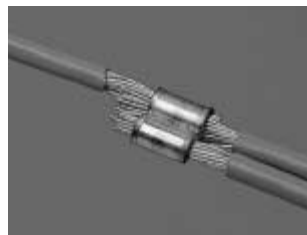

**RTM Crimpband Splices (Continued)**

**RTM Crimpband Interconnection System**

**How the System Operates**

- ① **Feed (Ribbon Connector Material)**  
Machine feeds strip until the strip hits the wire stop.
- ② **Shear (Blank Length)**  
The strip is cut by the cutter block former bar insert tooling.
- ③ **Bend (Crimp Formed)**  
The former bar drives the cut strip over the anvil, bending the cut strip into an upside down "U".
- ④ **Wire (Placement)**  
Pigtail and Parallel (Thru) splice terminations are made on the same machine.
- ⑤ **Crimp (Crimp Formed)**  
The anvil retracts as the driver takes the formed strip down into the clincher.

**Notes:** So that the proper Crimpband splice is chosen, Tyco Electronics recommends the following:

1. Submit 10 samples of wire combinations and/or components to be crimped with any special requirements to your Tyco Electronics sales representative.
2. Pull-out force and/or millivolt drop tests will be performed to develop recommendations for proper Crimpband material, toolset and crimp heights.
3. Tooling and testing will be documented on a Material & Tooling Sheet (M & T sheet).
4. Crimpband material quotes, tooling quotes and samples will be submitted to the customer.

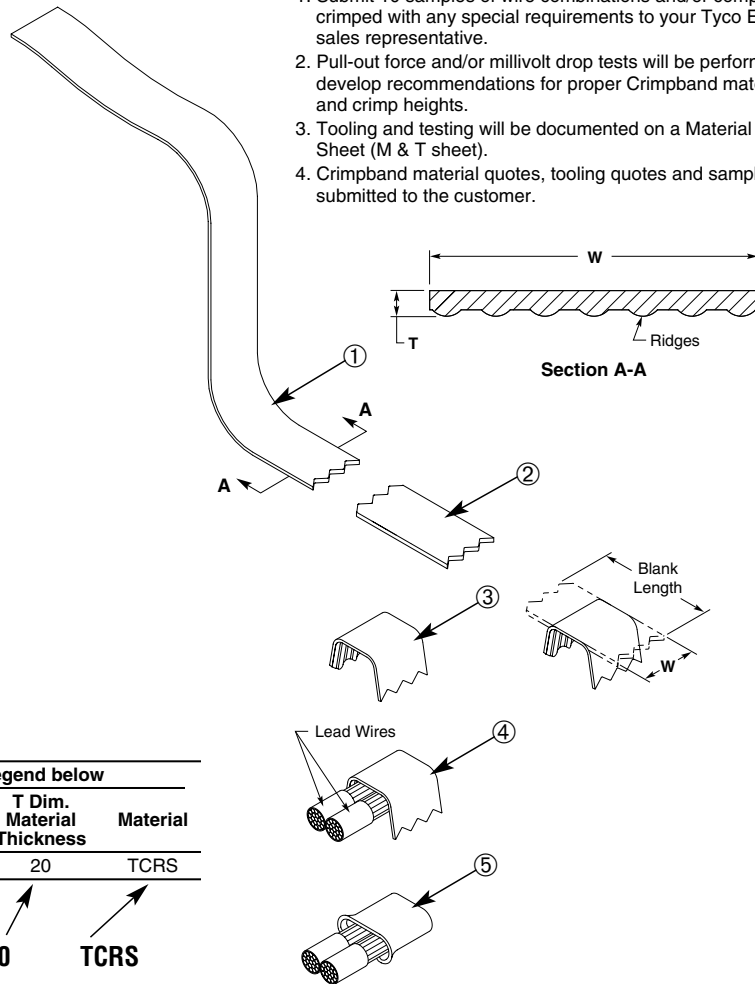

**Connector Specification Code**

See Figure 1 and/or Legend below

Machine Basis	B.L. Dim. Tooling Size	W Dim. Connector Width	T Dim. Material Thickness	Material
L	092	F	20	TCRS

Splice No. Example: **L** **092** **F** **20** **TCRS**

**Legend**

Machine Basis	
L	P
Leased	Purchase
Tooling Size Code	Blank Length B/L (Nom.)
032	.167
032/036	.228
036	.224
045	.246
051	.267
061	.292
061/076	.324
076	.339
076/092	.361
092	.379
092/125	.413
125	.446
125/160	.485
125/165	.506
165	.546

Connector Width Code	W Dim.	N No. of Ridges
B	.076	3
C	.138	6
D	.154	7
E	.185	8
F	.216	9
G	.234	10
H	.247	10
L	.086	3
M	.330	14
N	.500	20
P	.114	5

Material Thickness Code	T±.002 Dim.
12	.012
16	.016
18	.018
20	.020
22	.022
24	.024
25	.025

Material Code	Material/Finish
B	CDA 260 Brass
A	CDA 725 Copper/Nickel Alloy
TB	Pre-Tin over CDA 260 Brass
TCRS	1010 Cold Rolled Steel, Tin Plated
SS	301 or 302 Stainless Steel
ST	Stainless Steel, Tin Plated

Wire Size AWG	UL486C Pull Out Force Requirements Underwriters Laboratory (lbs.)
26	3
24	5
22	8
20	10
18	10
16	15
14	25
12	35
10	40

**Note:** For B/L above, .546 consult factory for tooling size code



**RTM Crimband Splices** (Continued)

**20 Ridges**

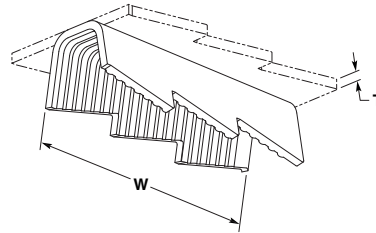

AWG/ mm <sup>2</sup>	Wire Range Solid Dia.	CMA Range	Stock Thk. (T)	Mat'l Width (W)	Material	Toolset	Part Number	Descriptive X-ref
11½-9 4.00-6.50	.084-.114 2.13-2.90	7000-13000	.020 0.51	.500 12.70	Tin Plated Brass	200/202	1601771-1	L200/202N20TB

**14 Ridges**

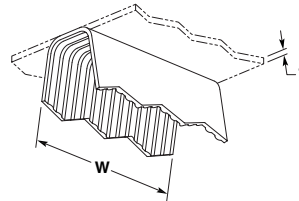

AWG/ mm <sup>2</sup>	Wire Range Solid Dia.	CMA Range	Stock Thk. (T)	Mat'l Width (W)	Material	Toolset	Part Number	Descriptive X-ref
22-19 0.38-0.60	.024-.036 0.61-0.91	600-1300	.012 0.30	.330 8.38	Cu Ni	045	1601577-1†	L045M12A
22-19 0.38-0.60	.024-.036 0.61-0.91	600-1300	.012 0.30	.330 8.38	Brass	045	1601578-1	L045M12B

† These part numbers are available upon special request; contact Tyco Electronics Engineering for details.

**10 Ridges**

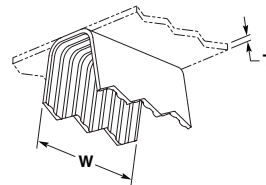

AWG/ mm <sup>2</sup>	Wire Range Solid Dia.	CMA Range	Stock Thk. (T)	Mat'l Width (W)	Material	Toolset	Part Number	Descriptive X-ref
22-19 0.38-0.60	.024-.036 0.61-0.91	600-1300	.012 0.30	.234 5.94	Brass	045	1601575-1	L045G12B
21-18½ 0.40-0.75	.028-.039 0.71-0.99	800-1500	.016 0.41	.234 5.94	Cu Ni	051	1601593-1†	L051G16A
20½-16 0.45-1.30	.030-.051 0.76-1.29	900-2600	.012 0.30	.234 5.94	Brass	061	1601632-1†	L061G12B
20½-16 0.45-1.30	.030-.051 0.76-1.29	900-2600	.020 0.51	.234 5.94	Brass	061	1601633-1	L061G20B
11½-9 4.00-6.50	.084-.114 2.13-2.90	7000-13000	.020 0.51	.234 5.94	Brass	200/202	1601853-1	P200/ 202G20B
11½-9 4.00-6.50	.084-.114 2.13-2.90	7000-13000	.025 0.64	.234 5.94	Brass	200/202	1601769-1	L200/ 202G25BX

† These part numbers are available upon special request; contact Tyco Electronics Engineering for details.

**RTM Crimpband Splices** (Continued)

**9 Ridges**

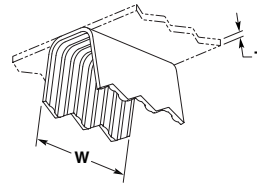

AWG/ mm <sup>2</sup>	Wire Range Solid Dia.	CMA Range	Stock Thk. (T)	Mat'l Width (W)	Material	Toolset	Part Number	Descriptive X-ref
22-19 0.38-0.60	.024-.036 0.61-0.91	600-1300	.012 0.30	.216 5.49	Stainless Steel	045	1601807-1	P045F12SS
20½-16 0.45-1.30	.030-.051 0.76-1.29	900-2600	.012 0.30	.216 5.49	Stainless Steel	061	1601520-1	G061F12SS

**8 Ridges**

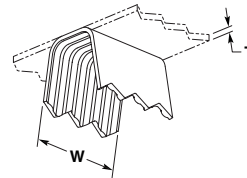

AWG/ mm <sup>2</sup>	Wire Range Solid Dia.	CMA Range	Stock Thk. (T)	Mat'l Width (W)	Material	Toolset	Part Number	Descriptive X-ref
24-20 0.20-0.50	.020-.033 0.51-0.84	400-1100	.012 0.30	.185 4.70	Cu Ni	032/036	1601553-1	L032/ 036E12A
18-14 0.80-2.00	.040-.063 1.02-1.60	1600-4000	.018 0.46	.185 4.70	Tin Plated CRS	076	1601669-1	L076E18TCRS
11½-9 4.00-6.50	.084-.114 2.13-2.90	7000-13000	.024 0.61	.185 4.70	Brass	200/202	1601768-1	L200/ 202E24B

**7 Ridges**

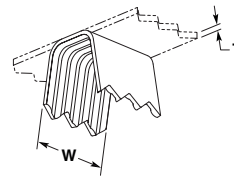

AWG/ mm <sup>2</sup>	Wire Range Solid Dia.	CMA Range	Stock Thk. (T)	Mat'l Width (W)	Material	Toolset	Part Number	Descriptive X-ref
24-20 0.20-0.50	.020-.033 0.51-0.84	400-1100	.012 0.30	.154 3.91	Brass	032/036	1601550-1	L032/ 036D12B
24-20 0.20-0.50	.020-.033 0.51-0.84	400-1100	.016 0.41	.154 3.91	Cu Ni	032/036	1601551-1	L032/ 036D16A
24-20 0.20-0.50	.020-.033 0.51-0.84	400-1100	.016 0.41	.154 3.91	Brass	032/036	1601797-1	P032/ 036D16B
24-20 0.20-0.50	.020-.033 0.51-0.84	400-1100	.016 0.41	.154 3.91	Tin Plated Brass	032/036	1601798-1	P032/ 036D16TB
22-19 0.38-0.60	.024-.036 0.61-0.91	600-1300	.012 0.30	.154 3.91	Brass	045	1601572-1	L045D12B
22-19 0.38-0.60	.024-.036 0.61-0.91	600-1300	.016 0.41	.154 3.91	Cu Ni	045	1601573-1	L045D16A

RTM Crimpband Splices

**RTM Crimpband Splices** (Continued)

**7 Ridges** (Continued)

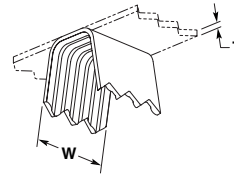

AWG/ mm <sup>2</sup>	Wire Range Solid Dia.	CMA Range	Stock Thk. (T)	Mat'l Width (W)	Material	Toolset	Part Number	Descriptive X-ref
22-19 0.38-0.60	.024-.036 0.61-0.91	600-1300	.016 0.41	.154 3.91	Brass	045	1601507-1†	G045D16B
21-18½ 0.40-0.75	.028-.039 0.71-0.99	800-1500	.012 0.30	.154 3.91	Brass	051	1601587-1	L051D12B
21-18½ 0.40-0.75	.028-.039 0.71-0.99	800-1500	.016 0.41	.154 3.91	Brass	051	1601588-1	L051D16B
21-18½ 0.40-0.75	.028-.039 0.71-0.99	800-1500	.020 0.51	.154 3.91	Nickel Plated Steel	051	1601591-1	L051D20NPS
21-18½ 0.40-0.75	.028-.039 0.71-0.99	800-1500	.020 0.51	.154 3.91	Tin Plated CRS	051	1601811-1†	P051D20TCRS
20½-16 0.45-1.30	.030-.051 0.76-1.29	900-2600	.012 0.30	.154 3.91	Cu Ni	061	1601818-1†	P061D12A
20½-16 0.45-1.30	.030-.051 0.76-1.29	900-2600	.012 0.30	.154 3.91	Brass	061	1601620-1†	L061D12B
20½-16 0.45-1.30	.030-.051 0.76-1.29	900-2600	.012 0.30	.154 3.91	Tin Plated Brass	061	1601514-1†	G061D12TB
20½-16 0.45-1.30	.030-.051 0.76-1.29	900-2600	.016 0.41	.154 3.91	Cu Ni	061	1601819-1	P061D16A
20½-16 0.45-1.30	.030-.051 0.76-1.29	900-2600	.016 0.41	.154 3.91	Brass	061	1601820-1	P061D16B
20½-16 0.45-1.30	.030-.051 0.76-1.29	900-2600	.016 0.41	.154 3.91	Tin Plated Brass	061	1601623-1	L061D16TB
20½-16 0.45-1.30	.030-.051 0.76-1.29	900-2600	.018 0.46	.154 3.91	Brass	061	1601625-1	L061D18B
20½-16 0.45-1.30	.030-.051 0.76-1.29	900-2600	.018 0.46	.154 3.91	Tin Plated Brass	061	1601628-1	L061D18TB
20½-16 0.45-1.30	.030-.051 0.76-1.29	900-2600	.020 0.51	.154 3.91	Cu Ni	061	1601629-1	L061D20A
20½-16 0.45-1.30	.030-.051 0.76-1.29	900-2600	.020 0.51	.154 3.91	Brass	061	1601630-1	L061D20B
20½-16 0.45-1.30	.030-.051 0.76-1.29	900-2600	.020 0.51	.154 3.91	Tin Plated Brass	061	1601631-1	L061D20TBX
20-15 0.60-1.60	.033-.057 0.84-1.45	1100-3200	.016 0.41	.154 3.91	Brass	061/076	1601601-1	L061/076D16B
19½-14½ 0.60-1.80	.035-.061 0.89-1.54	1200-3700	.016 0.41	.154 3.91	Brass	061/092	1601603-1	L061/092D16B
18-14 0.80-2.00	.040-.063 1.02-1.60	1600-4000	.012 0.30	.154 3.91	Cu Ni	076	1601828-1	P076D12A
18-14 0.80-2.00	.040-.063 1.02-1.60	1600-4000	.012 0.30	.154 3.91	Brass	076	1601655-1†	L076D12B
18-14 0.80-2.00	.040-.063 1.02-1.60	1600-4000	.016 0.41	.154 3.91	Cu Ni	076	1601656-1	L076D16A
18-14 0.80-2.00	.040-.063 1.02-1.60	1600-4000	.016 0.41	.154 3.91	Brass	076	1601829-1	P076D16B
18-14 0.80-2.00	.040-.063 1.02-1.60	1600-4000	.016 0.41	.154 3.91	Tin Plated Brass	076	1601658-1	L076D16TB
18-14 0.80-2.00	.040-.063 1.02-1.60	1600-4000	.018 0.46	.154 3.91	Cu Ni	076	1601660-1	L076D18AX
18-14 0.80-2.00	.040-.063 1.02-1.60	1600-4000	.018 0.46	.154 3.91	Brass	076	1601661-1	L076D18B
18-14 0.80-2.00	.040-.063 1.02-1.60	1600-4000	.018 0.46	.154 3.91	Tin Plated Brass	076	1601664-1	L076D18TB
18-14 0.80-2.00	.040-.063 1.02-1.60	1600-4000	.020 0.51	.154 3.91	Brass	076	1601665-1	L076D20B
18-14 0.80-2.00	.040-.063 1.02-1.60	1600-4000	.020 0.51	.154 3.91	Tin Plated CRS	076	1601667-1	L076D20TCRS
18-14 0.80-2.00	.040-.063 1.02-1.60	1600-4000	.024 0.61	.154 3.91	Brass	076	1601668-1	L076D24B

† These part numbers are available upon special request; contact Tyco Electronics Engineering for details.

**RTM Crimband Splices** (Continued)

**7 Ridges** (Continued)

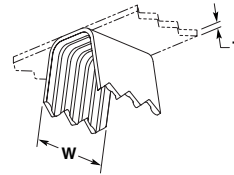

RTM Crimband Splices

AWG/ mm <sup>2</sup>	Wire Range Solid Dia.	CMA Range	Stock Thk. (T)	Mat'l Width (W)	Material	Toolset	Part Number	Descriptive X-ref
17½-13 0.95-2.54	.042-.068 1.07-1.80	1800-4600	.016 0.41	.154 3.91	Brass	076/092	1601642-1	L076/ 092D16BX
16½-13 1.10-2.60	.047-.072 1.19-1.83	2200-5200	.016 0.41	.154 3.91	Cu Ni	092	1601689-1	L092D16ASP
16½-13 1.10-2.60	.047-.072 1.19-1.83	2200-5200	.016 0.41	.154 3.91	Brass	092	1601691-1	L092D16B
16½-13 1.10-2.60	.047-.072 1.19-1.83	2200-5200	.016 0.41	.154 3.91	Tin Plated Brass	092	1601693-1	L092D16TB
16½-13 1.10-2.60	.047-.072 1.19-1.83	2200-5200	.018 0.46	.154 3.91	Cu Ni	092	1601694-1	L092D18A
16½-13 1.10-2.60	.047-.072 1.19-1.83	2200-5200	.018 0.46	.154 3.91	Brass	092	1601695-1	L092D18B
16½-13 1.10-2.60	.047-.072 1.19-1.83	2200-5200	.018 0.46	.154 3.91	Tin Plated Brass	092	1601841-1	P092D18TB
16½-13 1.10-2.60	.047-.072 1.19-1.83	2200-5200	.020 0.51	.154 3.91	Brass	092	1601528-1†	G092D20B
16-12 1.30-3.46	.051-.078 1.29-1.98	2600-6100	.020 0.51	.154 3.91	Cu Ni	092/125	1601680-1	L092/ 125D20A
16-12 1.30-3.46	.051-.078 1.29-1.98	2600-6100	.020 0.51	.154 3.91	Brass	092/125	1601681-1	L092/ 125D20B
16-12 1.30-3.46	.051-.078 1.29-1.98	2600-6100	.020 0.51	.154 3.91	Tin Plated CRS	092/125	1601682-1	092/ 125D20TCRS
15½-12 1.54-3.46	.055-.082 1.40-2.10	3000-6750	.016 0.41	.154 3.91	Brass	125	1601529-1	G125D16B
15½-12 1.54-3.46	.055-.082 1.40-2.10	3000-6750	.018 0.46	.154 3.91	Cu Ni	125	1601531-1	G125D18A
15½-12 1.54-3.46	.055-.082 1.40-2.10	3000-6750	.018 0.46	.154 3.91	Brass	125	1601726-1	L125D18B
15½-12 1.54-3.46	.055-.082 1.40-2.10	3000-6750	.018 0.46	.154 3.91	Tin Plated Brass	125	1601729-1	L125D18TBX
15½-12 1.54-3.46	.055-.082 1.40-2.10	3000-6750	.020 0.51	.154 3.91	Brass	125	1601730-1	L125D20B
15½-12 1.54-3.46	.055-.082 1.40-2.10	3000-6750	.020 0.51	.154 3.91	Tin Plated Brass	125	1601731-1	L125D20TB
15½-12 1.54-3.46	.055-.082 1.40-2.10	3000-6750	.020 0.51	.154 3.91	Tin Plated CRS	125	1601733-1	L125D20TCRS
14½-11½ 1.80-4.00	.059-.087 1.50-2.21	3500-7500	.018 0.46	.154 3.91	Tin Plated Brass	125/165	1601709-1	L125/ 165D18TB
14½-11½ 1.80-4.00	.059-.087 1.50-2.21	3500-7500	.020 0.51	.154 3.91	Cu Ni	125/165	1601710-1	L125/ 165D20A
14½-11½ 1.80-4.00	.059-.087 1.50-2.21	3500-7500	.020 0.51	.154 3.91	Brass	125/165	1601711-1	L125/ 165D20B
14½-11½ 1.80-4.00	.059-.087 1.50-2.21	3500-7500	.020 0.51	.154 3.91	Tin Plated Brass	125/165	1601712-1	L125/ 165D20TB
14-11 2.00-4.20	.063-.092 1.60-2.34	4000-8500	.020 0.51	.154 3.91	Cu Ni	165	1601754-1†	L165D20A
14-11 2.00-4.20	.063-.092 1.60-2.34	4000-8500	.020 0.51	.154 3.91	Brass	165	1601755-1	L165D20B
13½-10½ 2.54-4.50	.071-.097 1.70-2.46	4500-9500	.020 0.51	.154 3.91	Brass	165/200	1601532-1	G165/ 200D20B
11½-9 4.00-6.50	.084-.114 2.13-2.90	7000-13000	.016 0.41	.154 3.91	Brass	200/202	1601764-1	L200/ 202D16B
11½-9 4.00-6.50	.084-.114 2.13-2.90	7000-13000	.020 0.51	.154 3.91	Cu Ni	200/202	1601765-1	L200/ 202D20A
11½-9 4.00-6.50	.084-.114 2.13-2.90	7000-13000	.020 0.51	.154 3.91	Brass	200/202	1601852-1	P200/ 202D20B
11½-9 4.00-6.50	.084-.114 2.13-2.90	7000-13000	.020 0.51	.154 3.91	Tin Plated Brass	200/202	1601766-1	L200/ 202D20TB

† These part numbers are available upon special request; contact Tyco Electronics Engineering for details.

**RTM Crimband Splices** (Continued)

**6 Ridges**

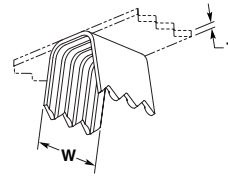

AWG/ mm <sup>2</sup>	Wire Range Solid Dia.	CMA Range	Stock Thk. (T)	Mat'l Width (W)	Material	Toolset	Part Number	Descriptive X-ref
24-20 0.20-0.50	<b>.020-.033</b> 0.51-0.84	400-1100	<b>.012</b> 0.30	<b>.138</b> 3.51	Tin Plated Brass	032/036	1601548-1	L032/ 036C12TB
24-20 0.20-0.50	<b>.020-.033</b> 0.51-0.84	400-1100	<b>.016</b> 0.41	<b>.138</b> 3.51	Brass	032/036	1601549-1	L032/ 036C16B
22-19 0.38-0.60	<b>.024-.036</b> 0.61-0.91	600-1300	<b>.012</b> 0.30	<b>.138</b> 3.51	Brass	045	1601566-1	L045C12B
22-19 0.38-0.60	<b>.024-.036</b> 0.61-0.91	600-1300	<b>.016</b> 0.41	<b>.138</b> 3.51	Cu Ni	045	1601569-1	L045C16A
22-19 0.38-0.60	<b>.024-.036</b> 0.61-0.91	600-1300	<b>.016</b> 0.41	<b>.138</b> 3.51	Brass	045	1601571-1	L045C16B
21-18½ 0.40-0.75	<b>.028-.039</b> 0.71-0.99	800-1500	<b>.012</b> 0.30	<b>.138</b> 3.51	Brass	051	1601808-1†	P051C12B
21-18½ 0.40-0.75	<b>.028-.039</b> 0.71-0.99	800-1500	<b>.016</b> 0.41	<b>.138</b> 3.51	Cu Ni	051	1601809-1	P051C16A
21-18½ 0.40-0.75	<b>.028-.039</b> 0.71-0.99	800-1500	<b>.016</b> 0.41	<b>.138</b> 3.51	Brass	051	1601810-1	P051C16B
21-18½ 0.40-0.75	<b>.028-.039</b> 0.71-0.99	800-1500	<b>.018</b> 0.46	<b>.138</b> 3.51	Brass	051	1601586-1†	L051C18B
20½-16 0.45-1.30	<b>.030-.051</b> 0.76-1.29	900-2600	<b>.016</b> 0.41	<b>.138</b> 3.51	Cu Ni	061	1601614-1	L061C16A
20½-16 0.45-1.30	<b>.030-.051</b> 0.76-1.29	900-2600	<b>.016</b> 0.41	<b>.138</b> 3.51	Brass	061	1601511-1	G061C16B
20½-16 0.45-1.30	<b>.030-.051</b> 0.76-1.29	900-2600	<b>.016</b> 0.41	<b>.138</b> 3.51	Tin Plated Brass	061	1601617-1	L061C16TB
20½-16 0.45-1.30	<b>.030-.051</b> 0.76-1.29	900-2600	<b>.018</b> 0.46	<b>.138</b> 3.51	Cu Ni	061	1601618-1	L061C18AX
20½-16 0.45-1.30	<b>.030-.051</b> 0.76-1.29	900-2600	<b>.018</b> 0.46	<b>.138</b> 3.51	Brass	061	1601619-1	L061C18B
20½-16 0.45-1.30	<b>.030-.051</b> 0.76-1.29	900-2600	<b>.020</b> 0.51	<b>.138</b> 3.51	Brass	061	1601513-1†	G061C20B
20-15 0.60-1.60	<b>.033-.057</b> 0.84-1.45	1100-3200	<b>.016</b> 0.41	<b>.138</b> 3.51	Brass	061/076	1601597-1	L061/ 076C16B
20-15 0.60-1.60	<b>.033-.057</b> 0.84-1.45	1100-3200	<b>.016</b> 0.41	<b>.138</b> 3.51	Tin Plated Brass	061/076	1601599-1	L061/ 076C16TB
20-15 0.60-1.60	<b>.033-.057</b> 0.84-1.45	1100-3200	<b>.018</b> 0.46	<b>.138</b> 3.51	Brass	061/076	1601600-1†	L061/ 076C18B
18-14 0.80-2.00	<b>.040-.063</b> 1.02-1.60	1600-4000	<b>.016</b> 0.41	<b>.138</b> 3.51	Cu Ni	076	1601650-1	L076C16A
18-14 0.80-2.00	<b>.040-.063</b> 1.02-1.60	1600-4000	<b>.016</b> 0.41	<b>.138</b> 3.51	Brass	076	1601651-1	L076C16B
18-14 0.80-2.00	<b>.040-.063</b> 1.02-1.60	1600-4000	<b>.018</b> 0.46	<b>.138</b> 3.51	Cu Ni	076	1601652-1†	L076C18A
18-14 0.80-2.00	<b>.040-.063</b> 1.02-1.60	1600-4000	<b>.018</b> 0.46	<b>.138</b> 3.51	Brass	076	1601827-1	P076C18B
18-14 0.80-2.00	<b>.040-.063</b> 1.02-1.60	1600-4000	<b>.018</b> 0.46	<b>.138</b> 3.51	Tin Plated CRS	076	1601654-1†	L076C18TCRS
17½-13 0.95-2.54	<b>.042-.068</b> 1.07-1.80	1800-4600	<b>.016</b> 0.41	<b>.138</b> 3.51	Brass	076/092	1601640-1	L076/ 092C16B
16½-13 1.10-2.60	<b>.047-.072</b> 1.19-1.83	2200-5200	<b>.016</b> 0.41	<b>.138</b> 3.51	Cu Ni	092	1601837-1	P092C16AX
16½-13 1.10-2.60	<b>.047-.072</b> 1.19-1.83	2200-5200	<b>.016</b> 0.41	<b>.138</b> 3.51	Brass	092	1601687-1	L092C16B
15½-12 1.54-3.46	<b>.055-.082</b> 1.40-2.10	3000-6750	<b>.016</b> 0.41	<b>.138</b> 3.51	Tin Plated Brass	125	1601721-1	L125C16TB
15½-12 1.54-3.46	<b>.055-.082</b> 1.40-2.10	3000-6750	<b>.018</b> 0.46	<b>.138</b> 3.51	Cu Ni	125	1601722-1	L125C18A
15½-12 1.54-3.46	<b>.055-.082</b> 1.40-2.10	3000-6750	<b>.018</b> 0.46	<b>.138</b> 3.51	Brass	125	1601723-1	L125C18B

† These part numbers are available upon special request; contact Tyco Electronics Engineering for details.

**RTM Crimband Splices** (Continued)

**3 Ridges**

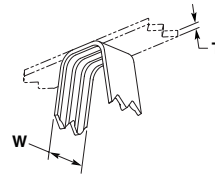

RTM Crimband Splices

AWG/ mm <sup>2</sup>	Wire Range Solid Dia.	CMA Range	Stock Thk. (T)	Mat'l Width (W)	Material	Toolset	Part Number	Descriptive X-ref
27½-21 0.09-0.40	.013-.028 0.33-0.71	170-800	.012 0.30	.076 1.93	Brass	032	1601555-1	L032B12B
24-20 0.20-0.50	.020-.033 0.51-0.84	400-1100	.012 0.30	.076 1.93	Cu Ni	032/036	1601542-1	L032/ 036B12A
24-20 0.20-0.50	.020-.033 0.51-0.84	400-1100	.012 0.30	.076 1.93	Brass	032/036	1601795-1	P032/ 036B12B
24-20 0.20-0.50	.020-.033 0.51-0.84	400-1100	.016 0.41	.076 1.93	Brass	032/036	1601545-1	L032/ 036B16B
24-20 0.20-0.50	.020-.033 0.51-0.84	400-1100	.016 0.41	.076 1.93	Tin Plated Brass	032/036	1601546-1	L032/ 036B16TB
24-20 0.20-0.50	.020-.033 0.51-0.84	400-1100	.018 0.46	.076 1.93	Brass	032/036	1601547-1†	L032/ 036B18B
22-19 0.38-0.60	.024-.036 0.61-0.91	600-1300	.016 0.41	.076 1.93	Cu Ni	045	1601503-1	G045B16A
22-19 0.38-0.60	.024-.036 0.61-0.91	600-1300	.016 0.41	.076 1.93	Brass	045	1601562-1	L045B16B
22-19 0.38-0.60	.024-.036 0.61-0.91	600-1300	.016 0.41	.076 1.93	Tin Plated Brass	045	1601504-1†	G045B16TB
22-19 0.38-0.60	.024-.036 0.61-0.91	600-1300	.016 0.41	.076 1.93	Tin Plated Brass	045	1601564-1	L045B16TBSP
21-18½ 0.40-0.75	.028-.039 0.71-0.99	800-1500	.016 0.41	.076 1.93	Cu Ni	051	1601580-1†	L051B16A
21-18½ 0.40-0.75	.028-.039 0.71-0.99	800-1500	.016 0.41	.076 1.93	Brass	051	1601582-1†	L051B16B
21-18½ 0.40-0.75	.028-.039 0.71-0.99	800-1500	.016 0.41	.076 1.93	Tin Plated Brass	045	1601583-1†	L051B16TB
21-18½ 0.40-0.75	.028-.039 0.71-0.99	800-1500	.020 0.51	.076 1.93	Brass	051	1601584-1	L051B20B
20½-16 0.45-1.30	.030-.051 0.76-1.29	900-2600	.016 0.41	.076 1.93	Tin Plated Brass	061	1601612-1†	L061B16TB
20½-16 0.45-1.30	.030-.051 0.76-1.29	900-2600	.016 0.41	.076 1.93	Cu Ni	061	1601610-1	L061B16A
20½-16 0.45-1.30	.030-.051 0.76-1.29	900-2600	.016 0.41	.076 1.93	Brass	061	1601611-1	L061B16B
20½-16 0.45-1.30	.030-.051 0.76-1.29	900-2600	.016 0.41	.076 1.93	Brass	061	1601635-1	L061L16B
20-15 0.60-1.60	.033-.057 0.84-1.45	1100-3200	.016 0.41	.076 1.93	Tin Plated Brass	061/076	1601596-1	L061/ 076B16TBX
18-14 0.80-2.00	.040-.063 1.02-1.60	1600-4000	.016 0.41	.076 1.93	Brass	076	1601825-1	P076B16B
18-14 0.80-2.00	.040-.063 1.02-1.60	1600-4000	.020 0.51	.076 1.93	Brass	076	1601649-1	L076B20B

† These part numbers are available upon special request; contact Tyco Electronics Engineering for details.

## MTM Crimband Splices

### Product Facts

- Made from a continuous coil of "Ribbon Connector" material
- Magnet wires MTM Crimband splices have machine-piercing serrations designed for displacing magnet wire insulation
- Available in brass, tin-plated brass, and copper-nickel alloy material
- Make parallel or pigtail connections on same machine
- 100% of Crimband material is used in scrap free terminations
- Crimband material coupled with appropriate toolsets accommodate specific CMA ranges
- Produced in Tyco Electronics equipment on your production floor
- Meets UL 486C crimp tensile requirements

### Applications

- Motors windings and connections
- Coil connections
- Transformer windings and connections
- Lighting ballasts
- Power supplies

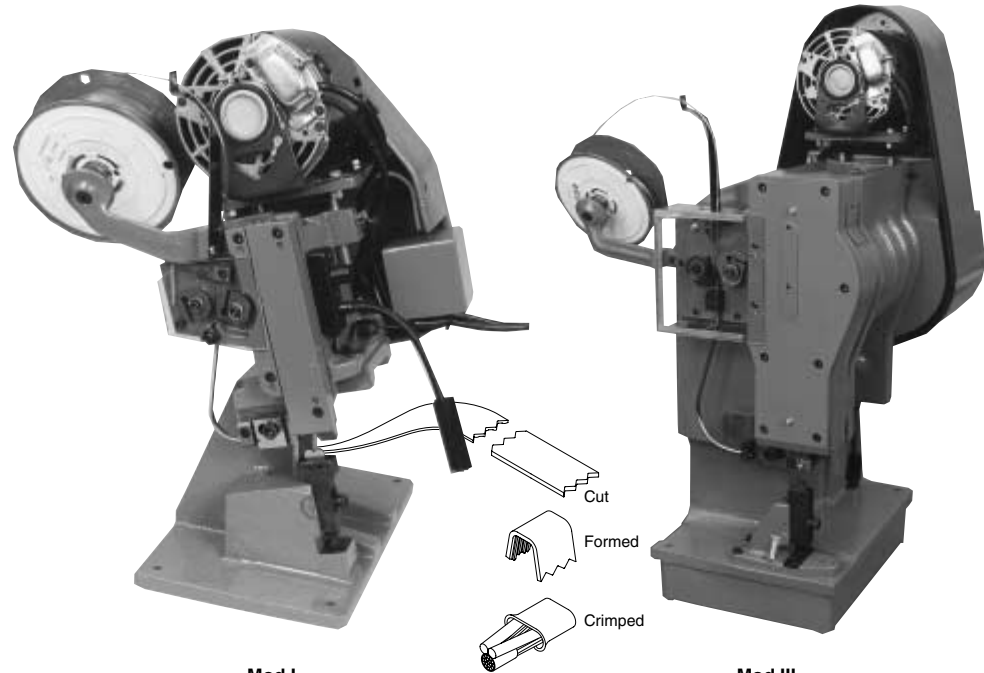

Mod I

Mod III

Tyco Electronics features the AMP MTM Crimband system that is comprised of two key features: the semi-automatic termination machine and a reel of MTM Crimband material.

In a one-step crimping operation, the machine feeds, cuts, forms and crimps the material to provide a low-cost, high reliability crimp connection.

The MTM Crimband splices are formed during the crimping process from

machined longitudinal grooved material that pierces magnet wire varnish film insulation during crimping.

MTM Crimband splices are specifically designed to terminate magnet wire to itself or in combination with standard solid or stranded lead wire.

Three magnet wires maximum can be terminated together with stranded lead wire in one splice.

Tyco Electronics provides a wide range of toolset types and Crimband splices to meet various production requirements.

Depending on your specific application, MTM Crimband splices are available in 7, 9, 11 and 13 serration versions for terminations in the 400 to 13,000 CMA range.

When aluminum magnet wire is used, MTM Crimband splices must be tin plated.

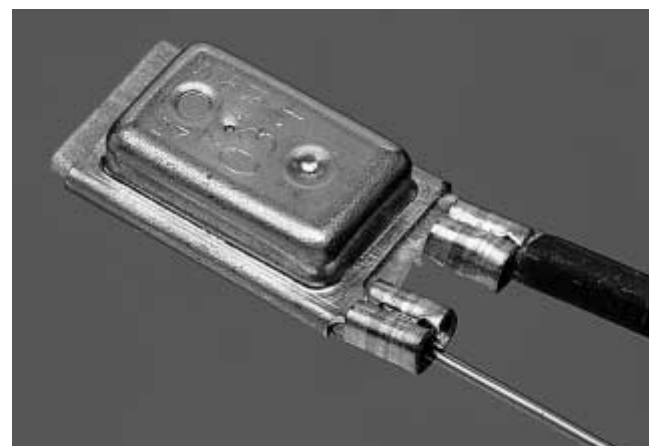

**MTM Crimpband Splices** (Continued)

**MTM Crimpband Interconnection System**

**How the System Operates**

- ① **Feed (Magnet Wire Connector Material)**  
Machine feeds strip until the strip hits the wire stop.
- ② **Shear (Blank Length)**  
The strip is cut by the cutter block former bar insert tooling.
- ③ **Bend (Crimp Formed)**  
The former bar drives the cut strip over the anvil, bending the cut strip into an upside down "U".
- ④ **Wire (Placement)**  
In Pigtail and Parallel (Thru) splices magnet wires must be placed on top of the lead wire.
- ⑤ **Crimp (Crimp Formed)**  
The anvil retracts as the driver takes the formed strip down into the clincher.

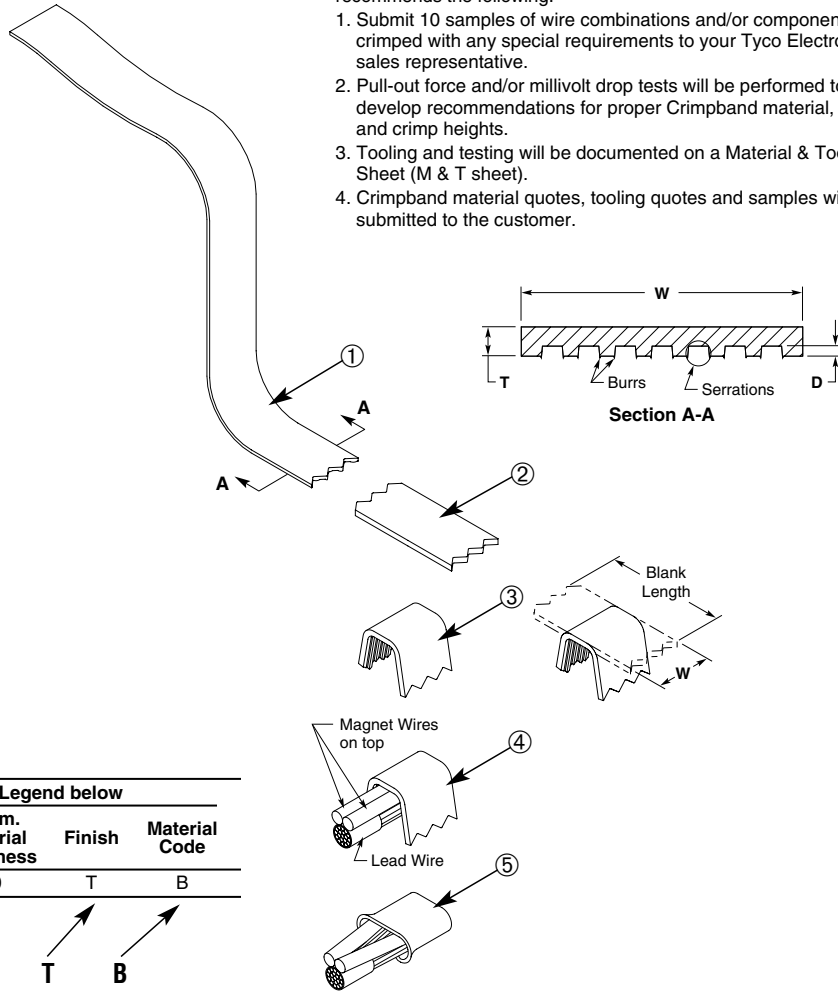

- Notes:** So that the proper Crimpband splice is chosen, Tyco Electronics recommends the following:
1. Submit 10 samples of wire combinations and/or components to be crimped with any special requirements to your Tyco Electronics sales representative.
  2. Pull-out force and/or millivolt drop tests will be performed to develop recommendations for proper Crimpband material, toolset and crimp heights.
  3. Tooling and testing will be documented on a Material & Tooling Sheet (M & T sheet).
  4. Crimpband material quotes, tooling quotes and samples will be submitted to the customer.

MTM Crimpband Splices

**Connector Specification Code**

See Figure 1 and/or Legend below					
Machine Basis	B.L. Dim. Tooling Size	W Dim. Connector Width	T Dim. Material Thickness	Finish	Material Code
L	092	6R	20	T	B

**Splice No. Example:** L 092 6R 20 T B

**Legend**

Machine Basis		
L	P	G*
Leased	Purchase	General

\* Customer has their own Tooling

Tooling Size Code	Blank Length B/L (Nom.)
032	.167
032/036	.228
036	.224
045	.246
051	.267
061	.292
061/076	.324
076	.339
076/092	.361
092	.379
092/125	.413
125	.446
125/160	.485
125/165	.506
165	.546

**Note:** For B/L above, .546 consult Tyco Electronics for tooling size code.

Connector Width Code	W
4R	5 Serrations .138
6R	7 Serrations .154
8R	9 Serrations .194
10R	11 Serrations .234

Material Thickness Code	T ±.002 Dim.	D Serration Depth
12	.012	.005
14	.014	.005
16	.016	.007
20	.020	.007
25	.025	.007

Material Code	Material/Finish
B	CDA 260 Brass
A	CDA 725 Copper/Nickel Alloy
TB	Pre-Tin over CDA 260 Brass

Wire Size AWG	UL486C Pull Out Force Requirements Underwriters Laboratory (lbs.)
26	3
24	5
22	8
20	10
18	10
16	15
14	25
12	35
10	40



**MTM Crimpband Splices** (Continued)

**11 Serrations**

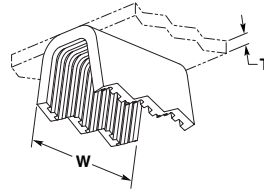

AWG/ mm <sup>2</sup>	Wire Range Solid Dia.	CMA Range	Stock Thk. (T)	Mat'l Width (W)	Material	Toolset	Part Number	Descriptive X-ref
14½-11½ 1.80-4.00	.059-.087 1.50-2.21	3500-7500	.025 0.64	.234 5.94	Brass	125/165	1601842-1	P125/ 16510R25B
14½-11½ 1.80-4.00	.059-.087 1.50-2.21	3500-7500	.025 0.64	.234 5.94	Tin Plated Brass	125/165	1601705-1	L125/ 16510R25TB
13½-10½ 2.54-4.50	.071-.097 1.70-2.46	4500-9500	.025 0.64	.234 5.94	Brass	165/200	1601847-1	P165/ 20010R25B
13½-10½ 2.54-4.50	.071-.097 1.70-2.46	4500-9500	.025 0.64	.234 5.94	Tin Plated Brass	165/200	1601848-1	P165/ 20010R25TB

**9 Serrations**

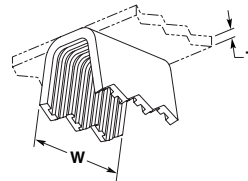

AWG/ mm <sup>2</sup>	Wire Range Solid Dia.	CMA Range	Stock Thk. (T)	Mat'l Width (W)	Material	Toolset	Part Number	Descriptive X-ref
24-20 0.20-0.50	.020-.033 0.51-0.84	400-1100	.016 0.41	.194 4.93	Tin Plated Brass	032/036	1601794-1†	P032/ 0368R16TB
20½-16 0.45-1.30	.030-.051 0.76-1.29	900-2600	.018 0.46	.194 4.93	Tin Plated Brass	061	1601607-1†	L0618R16TB
20½-16 0.45-1.30	.030-.051 0.76-1.29	900-2600	.018 0.46	.194 4.93	Brass	061	1601608-1	L0618R20B
20½-16 0.45-1.30	.030-.051 0.76-1.29	900-2600	.018 0.46	.194 4.93	Tin Plated Brass	061	1601814-1†	P0618R20TB
18-14 0.80-2.00	.040-.063 1.02-1.60	1600-4000	.016 0.41	.194 4.93	Tin Plated Brass	076	1601824-1	P0768R16TB
18-14 0.80-2.00	.040-.063 1.02-1.60	1600-4000	.020 0.51	.194 4.93	Tin Plated Brass	076	1601857-1	PO768R20TB
18-14 0.80-2.00	.040-.063 1.02-1.60	1800-4600	.020 0.51	.194 4.93	Brass	076/092	1601823-1	P076/ 0928R20B
18-14 0.80-2.00	.040-.063 1.02-1.60	1800-4600	.020 0.51	.194 4.93	Tin Plated Brass	076/092	1601639-1	L076/ 0928R20TB
16-12 1.30-3.46	.051-.078 1.29-1.98	2600-6100	.020 0.51	.194 4.93	Brass	092/125	1601833-1	P092/ 1258R20B
16-12 1.30-3.46	.051-.078 1.29-1.98	2600-6100	.020 0.51	.194 4.93	Tin Plated Brass	092/125	1601677-1	L092/ 1258R20TB
16-12 1.30-3.46	.051-.078 1.29-1.98	2600-6100	.025 0.64	.194 4.93	Brass	092/125	1601678-1†	L092/ 1258R25B
16-12 1.30-3.46	.051-.078 1.29-1.98	2600-6100	.025 0.64	.194 4.93	Tin Plated Brass	092/125	1601835-1†	P092/ 1258R25TB
15½-12 1.54-3.46	.055-.082 1.40-2.10	3000-6750	.016 0.41	.194 4.93	Brass	125	1601717-1†	L1258R16B
15½-12 1.54-3.46	.055-.082 1.40-2.10	3000-6750	.016 0.41	.194 4.93	Tin Plated Brass	125	1601718-1	L1258R16TB
15½-12 1.54-3.46	.055-.082 1.40-2.10	3000-6750	.020 0.51	.194 4.93	Brass	125	1601846-1	P1258R20B
15½-12 1.54-3.46	.055-.082 1.40-2.10	3000-6750	.025 0.64	.194 4.93	Brass	125	1601719-1	L1258R25B
14½-11½ 1.80-4.00	.059-.087 1.50-2.21	3500-7500	.025 0.64	.194 4.93	Brass	125/165	1601706-1	L125/ 1658R25B
14½-11½ 1.80-4.00	.059-.087 1.50-2.21	3500-7500	.025 0.64	.194 4.93	Tin Plated Brass	125/165	1601707-1	L125/ 1658R25TB
14-11 2.00-4.20	.063-.092 1.60-2.34	4000-8500	.025 0.64	.194 4.93	Tin Plated Brass	165	1601750-1†	L1658R25TB
11½-9 4.00-6.50	.084-.114 2.13-2.90	7000-13000	.025 0.64	.194 4.93	Tin Plated Brass	200/202	1601761-1	L200/ 2028R25TB

† These part numbers are available upon special request; contact Tyco Electronics Engineering for details.

MTM Crimpband Splices

**MTM Crimband Splices** (Continued)

**7 Serrations**

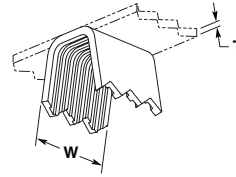

AWG/ mm <sup>2</sup>	Wire Range Solid Dia.	CMA Range	Stock Thk. (T)	Mat'l Width (W)	Material	Toolset	Part Number	Descriptive X-ref
27½-21 0.09-0.40	.013-.028 0.33-0.71	170-800	.012 0.30	.154 3.91	Brass	032	1601800-1	P0326R12BUF <sup>1</sup>
24-20 0.20-0.50	.020-.033 0.51-0.84	400-1100	.012 0.30	.154 3.91	Brass	032/036	1601539-1	L032/ 0366R12B
24-20 0.20-0.50	.020-.033 0.51-0.84	400-1100	.012 0.30	.154 3.91	Cu Ni	032/036	1601538-1	L032/ 0366R12AUF <sup>1</sup>
24-20 0.20-0.50	.020-.033 0.51-0.84	400-1100	.016 0.41	.154 3.91	Brass	032/036	1601540-1	L032/ 0366R16B
24-20 0.20-0.50	.020-.033 0.51-0.84	400-1100	.016 0.41	.154 3.91	Tin Plated Brass	032/036	1601793-1	P032/ 0366R16TB
22-19 0.38-0.60	.024-.036 0.70-0.91	600-1300	.016 0.41	.154 3.91	Brass	045	1601559-1	L0456R16B
22-19 0.38-0.60	.024-.036 0.70-0.91	600-1300	.020 0.51	.154 3.91	Brass	045	1601560-1†	L0456R20B
20½-16 0.45-1.30	.030-.051 0.76-1.29	900-2600	.016 0.41	.154 3.91	Brass	061	1601604-1	L0616R16B
20½-16 0.45-1.30	.030-.051 0.76-1.29	900-2600	.016 0.41	.154 3.91	Tin Plated Brass	061	1601606-1	L0616R16TB
18-14 0.80-2.00	.040-.063 1.02-1.60	1600-4000	.016 0.41	.154 3.91	Brass	076	1601644-1	L0766R16B
18-14 0.80-2.00	.040-.063 1.02-1.60	1600-4000	.016 0.41	.154 3.91	Tin Plated Brass	076	1601646-1†	L0766R16TB
18-14 0.80-2.00	.040-.063 1.02-1.60	1600-4000	.020 0.51	.154 3.91	Brass	076	1601647-1†	L0766R20B
17½-13½ 0.95-2.54	.042-.068 1.07-1.80	1800-4600	.016 0.41	.154 3.91	Brass	076/092	1601637-1	L076/ 0926R16BX
16½-13 1.10-2.60	.047-.072 1.19-1.83	2200-5200	.016 0.41	.154 3.91	Tin Plated Brass	092	1601683-1	L0926R16TB
16-12 1.30-3.46	.051-.078 1.29-1.98	2600-6100	.016 0.41	.154 3.91	Tin Plated Brass	092/125	1601675-1	L092/ 1256R16TB
16-12 1.30-3.46	.051-.078 1.29-1.98	2600-6100	.020 0.51	.154 3.91	Brass	092/125	1601832-1	P092/ 1256R20B
15½-12 1.54-3.46	.055-.082 1.40-2.10	3000-6750	.012 0.30	.154 3.91	Brass	125	1601844-1	P1256R12B
15½-12 1.54-3.46	.055-.082 1.40-2.10	3000-6750	.016 0.41	.154 3.91	Brass	125	1601845-1	P1256R16B
15½-12 1.54-3.46	.055-.082 1.40-2.10	3000-6750	.016 0.41	.154 3.91	Tin Plated Brass	125	1601716-1†	L1256R16TB

<sup>1</sup> UF designates Ultra-Fine serrations which are recommended for applications using wire size 28 AWG [0.32 mm] or smaller.

† These part numbers are available upon special request; contact Tyco Electronics Engineering for details.

MTM Crimband Splices

**AMPLIVAR Splices**

**Product Facts**

- Compression crimp eliminates cold solder points, weld burns and wire embrittlement usually associated with thermal-type terminations
- Excellent tensile strength—vibration resistant
- Provides a superior electrical connection that is free of many contaminants such as stripper residue and solder flux
- Precision formed, strip-fed splices terminated in AMP automatic machines for high production rates per hour
- High termination rates, low wire consumption and the elimination of rejects caused by solder flux or heat damage results in the lowest applied costs
- Precisely controlled crimp termination helps eliminate human error for maximum reliability
- Splice up to 3 magnet wires together with stranded lead in one barrel

**Applications**

- Motor windings and connections
- Coil connections
- Transformer windings and connections
- Solid wire connections
- Lighting ballasts
- Power supplies
- Starters and alternators

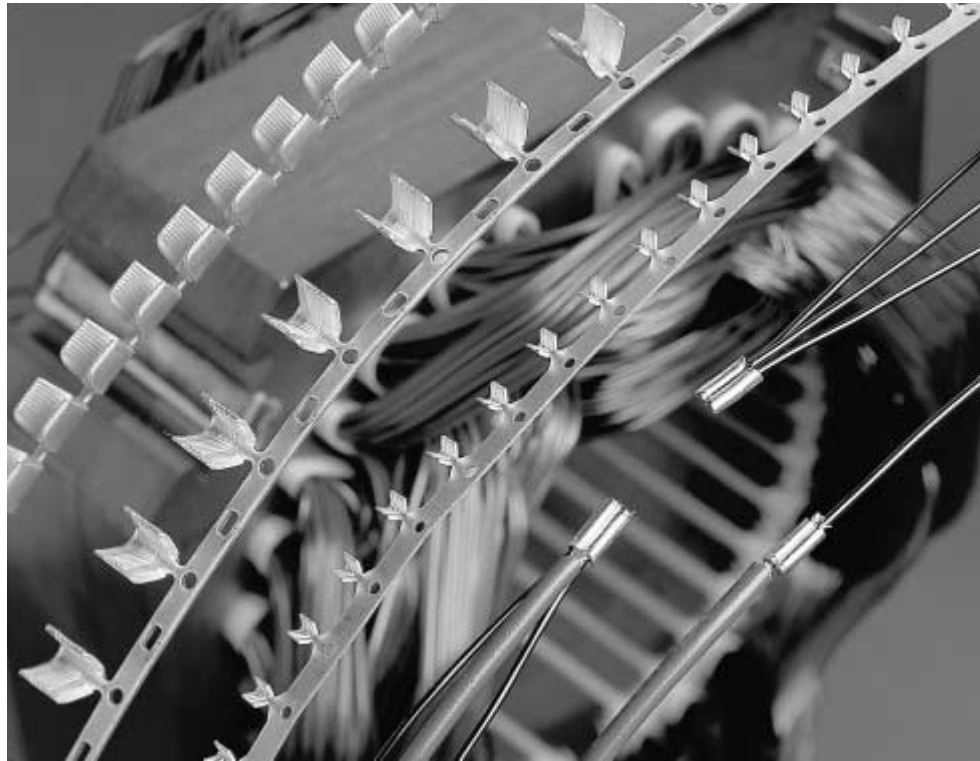

Tyco Electronics offers a full selection of AMPLIVAR splices that are specifically designed to terminate magnet wire to itself or in combination with standard solid or stranded lead wire.

AMPLIVAR splices have machined, sharp edged serrations inside the crimp barrels. These serrations, made by a special production process, pierce the insulating layer of magnet wires in a manner that provides a large contact area.

In a one-step operation the magnet wire is automatically multiple ring-stripped of its insulation as it is forced into

the serrations during the precisely controlled crimp.

The resulting termination produces a high tensile strength, air-sealed connection that is as resistant to corrosion as the insulated conductor.

As many as three magnet wires can be terminated simultaneously in one splice. In addition, copper or aluminum magnet wire, or a combination of both, can be terminated.

When required, copper or aluminum magnet wire can be combined with standard,

pre-stripped solid or stranded lead wires.

Depending on your specific application, AMPLIVAR splices are available in 5, 7 and 9 serration versions for terminations in the 100 to 22,000 CMA range as well as miniature and subminiature designs for terminations in the 100 to 1850 CMA range.

The crimping of AMPLIVAR splices is done by semi-automatic crimping machines for high output per hour production rates.

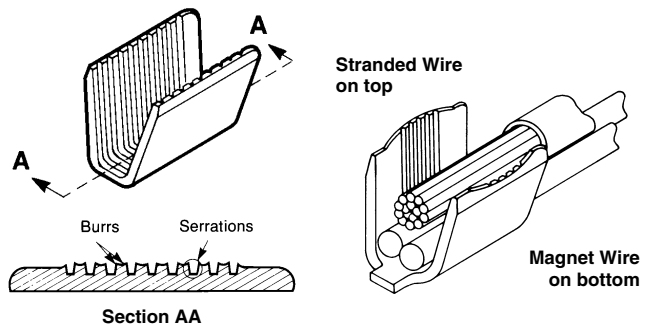

AMPLIVAR Splices

**AMPLIVAR Splices** (Continued)

**Technical Features**

**Applicable Types of Wire** — Cu, Al (Solid) together or in combination with stranded lead wire

**Wire Size Range** — from 300 to 13,000 CMA (0.1 mm<sup>2</sup> to 6.6 mm<sup>2</sup>)

**Terminal Base Material** — Brass, phosphor bronze

**Surface Finish** — plain and tin plated except where noted

**Temperature Range** — -65°C to +150°C

**Rated Current** — according connected wire size

**Rated Voltage** — according terminated winding

**Test Results**

The AMPLIVAR products have been subjected to the following tests without significant millivolt losses.

**Temperature Cycling** — 25 cycles with each cycle consisting of 30 minutes at +125°C followed by 30 minutes at -65°C

**Heat Age** — 96 hours at +150°C

**Thermal Shock** — 25 cycles with each cycle consisting of 30 minutes at +150°C followed by 30 minutes at -65°C

**Salt Spray** — 96 hours at +35°C with a 5% salt solution spray

**Humidity** — 96 hours at 90–95% relative humidity and +40°C

**Current Cycling** — 10,000 cycles with each consisting of 3 minutes on and 3 minutes off at a current (25 A) which establishes a wire temperature of +150°C

**TYPICAL CURRENT CYCLING TEST RESULTS**

**Curve I 62040-1**  
#19 Aluminum Magnet Wire

**Curve II 62040-2**  
#19 Copper Magnet Wire

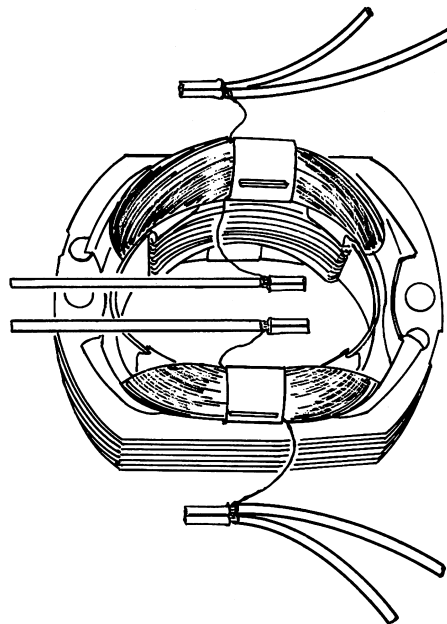
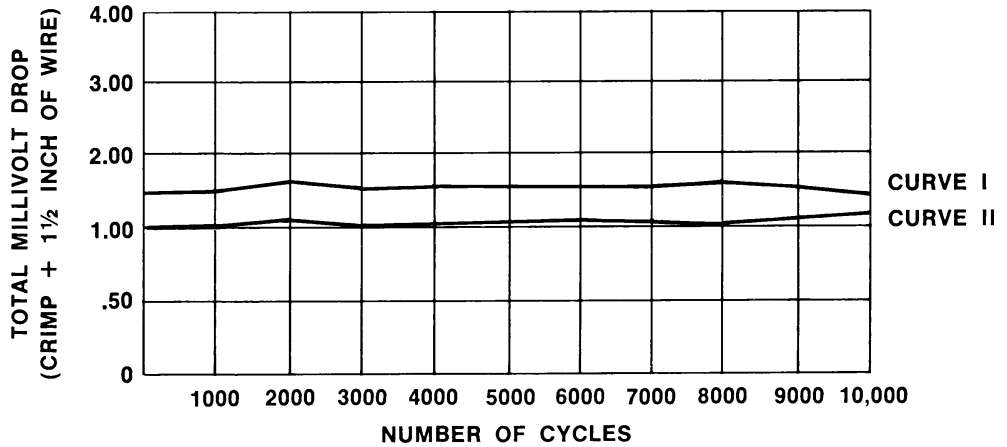

AMPLIVAR Splices

**AMPLIVAR Splices** (Continued)

**General Application Guidelines**

To assist you in obtaining the optimum AMPLIVAR splice termination, the following guidelines are recommended:

1. All magnet wires must be placed in the bottom of the wire barrel before crimping. If lead wire is to be crimped in the same termination, it should be placed on top of the magnet wires.
2. Wire barrels are designed to accept a maximum of three insulated magnet wires plus stranded lead wires.
3. The ratio of magnet wire diameters crimped in any wire barrel should not exceed 2:1. This ratio is approximately a range from the largest to the smallest magnet wire of six sizes.
4. The sum of the circular mil area (CMA) of the magnet wires and any lead wires should not exceed the capacity of the splice.
5. The sum of the diameters of the individual magnet wires plus twice the terminal stock thickness must be equal to or less than the crimp width.
6. Magnet wire of 26 AWG [0.40 mm] or smaller should be used with 7-serration splices having "shallow serrations," and magnet wire of 28 AWG [0.32 mm] or smaller should be used with 9-serration splices having "shallow serrations" (part numbers identified with asterisk [\*] are in the tabular data on the following technical pages).
7. Magnet wire of 20 AWG [0.81 mm] or larger having an insulation thickness heavier than "single film coated," should not be used with splices having "shallow serrations" (those part numbers marked with an asterisk [\*] in the tabular data on the following technical pages).
8. When aluminum magnet wire is used, splices and terminals must be tin plated.
9. Consult Tyco Electronics for splice and terminal selection and recommendations for all non-standard applications.

**Suggested Splice Selection Procedure**

Use the following guide to help you to determine the proper splice for your application:

1. Use 9-serration splices, tin plated when terminating aluminum magnet wire or combinations with aluminum magnet wire.
2. Use 9-serration splices for hermetic and severe environment applications.
3. Use splices identified with an asterisk [\*] when terminating 7-serration 26 AWG [0.40 mm] or smaller wires and 9-serration 28 AWG [0.32 mm] or smaller wires.
4. Calculate the total CMA of the magnet wires plus any lead wires to be terminated. Always use the coated magnet wire for CMA.
5. Calculate the total magnet wire diameters.
6. Select a splice for trial calculations. It should have the proper CMA range. Plating finish should be considered at this time.
7. Calculate the sum of the magnet wire diameters plus two splice stock thicknesses. If this total is less than the crimp width of the splice selected, it may be used. If the total is greater than the crimp width, a splice with a greater crimp width must be selected. Consult Tyco Electronics for special wide tooling recommendations.

**Example:**

- Selection of a Pigtail Splice to terminate the following wires:  
One 28 AWG [0.32 mm] copper magnet wire.  
One 22 AWG [0.64 mm] aluminum magnet wire.  
One 18 AWG [0.8–0.9 mm<sup>2</sup>] 19-strand copper lead wire.

- Calculate the total CMA (Procedure 4):  
28 AWG [0.32 mm] coated magnet wire = 185 CMA  
22 AWG [0.64 mm] coated magnet wire = 708 CMA  
18 AWG [0.8–0.9 mm<sup>2</sup>] stranded lead wire = 1608 CMA  
**Total = 2501 CMA**

- Calculate the sum of the magnet wire diameters (Procedure 5):  
28 AWG [0.32 mm] coated magnet wire = .0136 [0.35]  
22 AWG [0.64 mm] coated magnet wire = .0266 [0.68]  
**Total = .0402 [1.03]**

- Select a terminal for trial calculations. Splice No. 62305-2, page 46 (Procedure 6):  
CMA range = 600–3000  
Stock thickness = .016 [0.41]  
Crimp width = .110 [2.79]

9-serration, tin plated for aluminum magnet wire (Procedure 1).  
Splice identified with asterisk [\*] for 28 AWG [0.32 mm] (Procedure 3).

- Calculate the sum of the magnet wire diameters plus two splice stock thicknesses (Procedure 7):  
.0402 + (.016 x 2) = .0722  
[1.02 + (0.41 x 2) = 1.84  
.0722 [1.84] is less than the splice crimp width of .110 [2.79]; therefore, Part No. 62305-2 may be used.

**Technical Documents**

**Application Specifications** describe requirements for using the product in its intended application and or crimping information. They are intended for the Packaging and Design Engineer and the Machine Setup Person.

114-2002	AMPLIVAR 7-Serration Pigtail Splices	114-2006	AMPLIVAR Subminiature Pigtail Splices
114-2003	AMPLIVAR 9-Serration Pigtail Splices	114-2009	AMPLIVAR 5-Serration Thru Splices
114-2005	AMPLIVAR Subminiature Thru Splices	114-2016	AMPLIVAR Miniature Pigtail Splices

**AMPLIVAR Splices** (Continued)

**9 Serrations —  
Pigtail Type**

**Product Facts**

(Plus All 7 Serration Facts)

- Splice length is increased on larger CMA splices for improved performance
- Serration depths are varied within the splice to give optimum electrical/mechanical performance on all wire sizes
- Serration sidewall angles are varied to allow better wire stripping and serration fill
- Flat bottom of splice helps keep magnet wires on bottom as required during crimping
- Magnet wires 28 AWG [0.32 mm] and larger may be terminated without requiring shallow serrations
- Additional serrations enhance stability of crimp

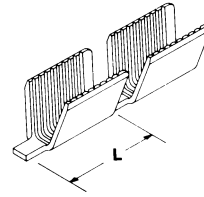

AWG/ mm <sup>2</sup>	Wire Range Solid Dia.	Wire Range CMA	Stock Thickness	Crimp Width	Dim. L	Material	Part Number
24-18.5 0.26-0.80	.020-.039 0.55-1.00	400-1500	.016 0.41	.080 2.03	.225 5.72	Tin Plated Brass	62303-2*
22-15.5 0.38-1.54	.028-.055 0.70-1.40	600-3000	.020 0.51	.110 2.79	.225 5.72	Tin Plated Brass	62304-2
22-15.5 0.38-1.54	.028-.055 0.70-1.40	600-3000	.016 0.41	.110 2.79	.225 5.72	Tin Plated Brass	62305-2*
18.5-13.5 0.80-2.54	.039-.071 1.00-1.80	1500-5000	.020 0.51	.110 2.79	.225 5.72	Tin Plated Brass	62306-2
18.5-13.5 0.80-2.54	.039-.071 1.00-1.80	1500-5000	.016 0.41	.110 2.79	.225 5.72	Tin Plated Brass	62307-2*
15.5-12 1.54-3.46	.055-.083 1.40-2.10	3000-7000	.020 0.51	.140 3.56	.265 6.73	Tin Plated Brass	62308-2
13.5-10 2.54-4.90	.071-.098 1.80-2.50	5000-10,000	.025 0.64	.180 4.57	.265 6.73	Tin Plated Brass	62309-2
12-9 3.46-6.38	.083-.112 2.10-2.85	7000-13,000	.025 0.64	.180 4.57	.265 6.73	Tin Plated Brass	62310-2
10-6.5 4.90-9.45	.098-.137 2.50-3.47	10,000-22,000	.030 0.76	.220 5.59	.340 8.64	Tin Plated Brass	62311-2 <sup>1</sup>

\*These splices are recommended for applications using wire size 28 AWG [0.32 mm] or smaller.  
<sup>1</sup> Special high force application equipment required.

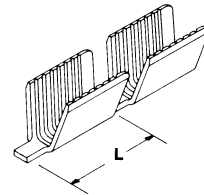

**7 Serrations —  
Pigtail Type**

**Product Facts**

- Taper on both crimper and anvil improves flex life of termination
- Longer “flat” on tooling improves electrical performance (.125 vs. .080 [3.18 vs. 2.03])
- Radius on wire entry end of splice helps prevent nicking wires and improves mechanical performance
- Serrations are offset to sheared end to place additional serrations in “electrical” portion of crimped splice
- Splice CMA ranges are overlapped so that two splices are available for any given CMA

AWG/ mm <sup>2</sup>	Wire Range Solid Dia.	Wire Range CMA	Stock Thickness	Crimp Width	Dim. L	Material	Part Number
22-15.5 0.38-1.54	.028-.055 0.70-1.40	600-3000	.020 0.51	.110 2.79	.225 5.72	Brass	62000-1
22-15.5 0.38-1.54	.028-.055 0.70-1.40	600-3000	.020 0.51	.110 2.79	.225 5.72	Brass	62157-1*
22-15.5 0.38-1.54	.028-.055 0.70-1.40	600-3000	.020 0.51	.110 2.79	.225 5.72	Tin Plated Brass	62000-2
22-15.5 0.38-1.54	.028-.055 0.70-1.40	600-3000	.020 0.51	.110 2.79	.225 5.72	Tin Plated Brass	62157-2*
22-15.5 0.38-1.54	.028-.055 0.70-1.40	600-3000	.020 0.51	.110 2.79	.225 5.72	Tin Plated Brass	62200-2 <sup>1</sup>
18.5-13.5 0.80-2.54	.039-.071 1.00-1.80	1500-5000	.020 0.51	.110 2.79	.225 5.72	Brass	62040-2
18.5-13.5 0.80-2.54	.039-.071 1.00-1.80	1500-5000	.020 0.51	.110 2.79	.225 5.72	Tin Plated Brass	62040-1
18.5-13.5 0.80-2.54	.039-.071 1.00-1.80	1500-5000	.020 0.51	.110 2.79	.225 5.72	Phosphor Bronze	964156-1
15.5-12 1.54-3.46	.055-.083 1.40-2.10	3000-7000	.020 0.51	.140 3.56	.225 5.72	Brass	62001-1
15.5-12 1.54-3.46	.055-.083 1.40-2.10	3000-7000	.020 0.51	.140 3.56	.225 5.72	Tin Plated Brass	62001-2
15.5-12 1.54-3.46	.055-.083 1.40-2.10	3000-7000	.020 0.51	.140 3.56	.225 5.72	Tin Plated Brass	62201-2 <sup>1</sup>
12-10 2.10-6.0	.085-.110 2.10-2.85	7000-12,000	.025 0.64	.250 6.35	.225 5.72	Tin Plated Brass	62295-1
12-10 2.10-6.0	.085-.110 2.10-2.85	7000-12,000	.025 0.64	.250 6.35	.225 5.72	Brass	62295-2
12-9 2.10-6.38	.085-.115 2.10-3.47	7000-13,000	.025 0.64	.180 4.57	.225 5.72	Tin Plated Brass	62002-2

\*These splices are recommended for applications using wire size 26 AWG [0.40 mm] or smaller.  
<sup>1</sup> Flat bottom.

AMPLIVAR Splices

**AMPLIVAR Splices** (Continued)

**7 Serrations —  
Thru Type**

**Product Facts**

- Crimp bellmouth provides retention in circular cavity slot in bobbin

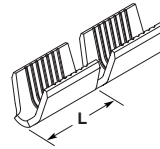

AWG/ mm <sup>2</sup>	Wire Range Solid Dia.	Wire Range CMA	Stock Thickness	Crimp Width	Dim. L	Material	Part Number
22-15.5 0.38-1.54	.028-.055 0.70-1.40	600-3000	.020 0.51	.110 2.79	.225 5.72	Tin Plated Brass	1217384-1*

\*These splices are recommended for applications using wire size 26 AWG [0.40 mm] or smaller.

**5 Serrations —  
Thru Type**

**Product Facts**

- Wide range of thru splices
- Serrations centered in splice to achieve optimum electrical and mechanical performance in a thru splice
- CMA range accepts a wide variety of wire sizes and combinations

**A**

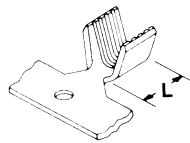

**B**

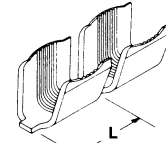

Type	AWG/ mm <sup>2</sup>	Wire Range Solid Dia.	Wire Range CMA	Stock Thickness	Crimp Width	Dim. L	Material	Part Number
A	17-12.5 1.00-2.80	.045-.075 1.15-1.85	2000-5400	.020 0.51	.110 5.08	.235 5.97	Brass	63564-1
	12-9 3.00-7.00	.077-.118 1.95-3.00	6000-14,000	.025 0.64	.180 4.57	.265 6.73	Brass	1217990-1
							Tin Plated Brass	1217990-2
	10-8 5.00-8.00	.100-.125 2.55-3.20	10,000-16,000	.032 0.80	.180 4.57	.267 6.78	Tin Plated Brass	63561-1
							Tin Plated Brass	63562-1
	10-7.5 5.00-11.50	.100-.150 2.60-3.80	10,400-22,900	.030 0.76	.300 7.62	.310 7.87	Tin Plated Brass	63562-1
							Brass	42076
	22-15.5 0.38-1.54	.028-.055 0.70-1.40	600-3000	.020 0.51	.110 2.79	.225 5.72	Brass	42076
							Brass	42192-1*
	22-15.5 0.38-1.54	.028-.055 0.70-1.40	600-3000	.020 0.51	.110 2.79	.225 5.72	Tin Plated Brass	42192-2*
Brass							42778-1* <sup>1</sup>	
22-15.5 0.38-1.54	.028-.055 0.70-1.40	600-3000	.020 0.51	.110 2.79	.225 5.72	Tin Plated Brass	42778-2* <sup>1</sup>	
						Brass	41765	
18.5-13.5 0.80-2.54	.039-.071 1.00-1.80	1500-5000	.020 0.51	.110 2.79	.225 5.72	Brass	41765	
						Tin Plated Brass	41899	
18.5-13.5 0.80-2.54	.039-.071 1.00-1.80	1500-5000	.020 0.51	.110 2.79	.225 5.72	Brass	42119-1*	
						Brass	42776-1* <sup>1</sup>	
18.5-13.5 0.80-2.54	.039-.071 1.00-1.80	1500-5000	.020 0.51	.110 2.79	.225 5.72	Tin Plated Brass	42776-2* <sup>1</sup>	
						Brass	41766	
15.5-12 1.54-3.46	.055-.083 1.40-2.10	3000-7000	.020 0.51	.140 3.56	.225 5.72	Brass	41766	
						Tin Plated Brass	41900	
15.5-12 1.54-3.46	.055-.083 1.40-2.10	3000-7000	.020 0.51	.140 3.56	.225 5.72	Brass	42779-11	
						Tin Plated Brass	42779-21	
15.5-12 1.54-3.46	.055-.083 1.40-2.10	3000-7000	.020 0.51	.140 3.56	.225 5.72	Tin Plated Brass	42779-21	
						Brass	61074-11. <sup>2</sup>	
12-10 3.46-6.00	.083-.110 2.10-2.80	7000-12,000	.025 0.64	.250 6.35	.225 5.72	Tin Plated Brass	61074-11. <sup>2</sup>	
						Brass	41770	
12-9 3.46-6.38	.083-.112 2.10-2.85	7000-13,000	.025 0.64	.180 4.57	.225 5.72	Tin Plated Brass	41904	
						Brass	42780-11	
12-9 3.46-6.38	.083-.112 2.10-2.85	7000-13,000	.025 0.64	.180 4.57	.225 5.72	Tin Plated Brass	42780-11	
						Brass	42780-21	
12-9 3.46-6.38	.083-.112 2.10-2.85	7000-13,000	.025 0.64	.180 4.57	.225 5.72	Tin Plated Brass	42780-21	
						Brass	42780-21	

\* These splices are recommended for applications using wire size 26 AWG [0.40 mm] or smaller.

<sup>1</sup> Increased terminal pitch.

<sup>2</sup> Increased U-diameter.

**AMPLIVAR Splices** (Continued)

**5 Serrations —  
Pigtail Type**

**Product Facts**

- Serration depths are varied within the splice to give optimum electrical / mechanical performance on all wire sizes
- Flat bottom of splice helps keep magnet wires on bottom as required during crimping

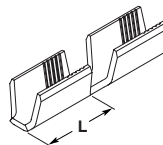

AWG/ mm <sup>2</sup>	Wire Range Solid Dia.	Wire Range CMA	Stock Thickness	Crimp Width	Dim. L	Material	Part Number
20-17	.030-.045	1000-2000	.016	.100	.225	Tin Plated Brass	62670-2*1
0.50-1.00	0.80-1.15		0.41	2.54	5.72		

\*These splices are recommended for applications using wire size 26 AWG [0.40 mm] or smaller.  
1 Flat bottom.

**Miniature Splice —  
Pigtail Type**

**Product Facts**

- The Miniature AMPLIVAR splice was developed for crimping thinner copper magnet wires having a diameter between .003 and .016 [0.08 and 0.40 mm] and has to be connected with a stranded conductor
- The diameter of one conductor strand should not exceed the magnet wire diameter to be applied

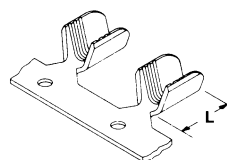

AWG/ mm <sup>2</sup>	Wire Range Solid Dia.	Wire Range CMA	Stock Thickness	Crimp Width	Dim. L	Material	Part Number
27-21	.014-.030	200-850	.012	.055	.195	Tin Plated Brass	63431-1
0.10-0.40	0.35-0.75		0.30	1.40	4.95		
25-18	.015-.045	300-1850	.012	.070	.195	Copper-Nickel	61166-1
0.16-0.90	0.45-1.10		0.30	1.78	4.95		
24-18.5	.020-.039	480-1500	.014	.080	.195	Tin Plated Brass	62341-1
0.20-0.75	0.55-1.00		0.36	2.03	4.95		
24-18.5	.020-.039	480-1500	.014	.080	.195	Brass	62341-2
0.20-0.75	0.55-1.00		0.36	2.03	4.95		
24-18	.020-.040	480-1700	.016	.070	.195	Brass	62044-1
0.20-0.80	0.55-1.00		0.41	1.78	4.95		

**Subminiature Splice —  
Thru or Pigtail Type**

**Product Facts**

- The compactness of these splices makes them ideal for use in small subfractional motors, transformers, relays, solenoids, indicator lamps and small appliance terminations
- These splices provide the same reliability as the larger AMPLIVAR splices

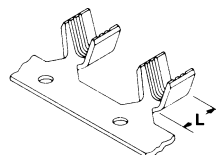

AWG/ mm <sup>2</sup>	Wire Range Solid Dia.	Wire Range CMA	Stock Thickness	Crimp Width	Dim. L	Material	Part Number
30-26	.010-.015	100-300	.010	.042	.080	Tin Plated Brass	63621-2
0.05-0.15	0.30-0.50		0.25	1.08	2.03		
24-19	.020-.035	400-1300	.016	.070	.100	Tin Plated Brass	62194-2
0.26-0.60	0.55-0.90		0.41	1.78	2.54		
24-19	.020-.035	400-1300	.016	.070	.100	Gold Plated Brass	62194-4
0.26-0.60	0.55-0.90		0.41	1.78	2.54		



**AMPLIVAR Application Tooling**

**AMPLIVAR Product Terminator (APT)**

**Product Facts**

- No need to strip magnet wire
- Connects up to 3 wires in 1 splice
- Crimp Quality Monitor (CQM) system measures crimp heights
- Machine shut height easily adjusts in .0005 [0.013] increments
- Quick-change tooling without major shut-height adjustments

**Specifications**

**Weight** — Approximately 150 lb [68 kg] with CQM

**Width** — 38 [965] with CQM and product reel

**Depth** — 35 [889]

**Height** — 14 [356]

**Electrical** — 120 VAC, 60 Hz, 1 A, 1f, or 240 VAC, 50 Hz, .5 A, 1f

**Air** — 80-100 psi [5.52-7.59 bar], 22 scfm [0.000141 m3/s]

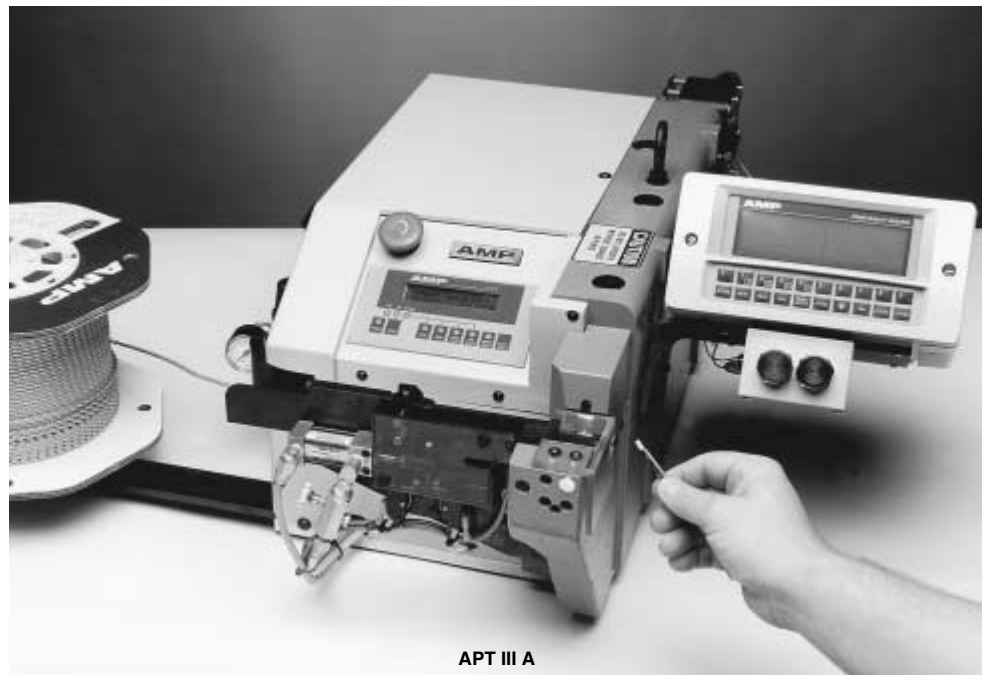

APT III A

For pigtail splice connection of magnet wire, the AMPLIVAR Product Terminator (APT) and strip-form AMPLIVAR products offer a fast and efficient system, with no need to strip mag-wire insulation. To apply a splice, simply place the wires in the target area and depress the foot switch. The machine automatically shears the splice from the strip, crimps it, shears off excess wire, and advances the next splice into position.

APT semi-automatic bench machines are available in two versions: the IIIA with automatic precision adjustment controlled by the Crimp Quality Monitor (CQM), and the IIE with manual precision adjustment.

With CQM, the APT IIIA assists in achieving 6-sigma processing capability. In addition to providing 100% inspection and automatic adjustment of crimp heights as needed, the CQM also evaluates the quality of each crimp. If a questionable crimp is detected, visual and audible alarms alert the operator.

For operations with multiple wire sizes, the APT IIIA provides programmable sequencing of different crimp-height settings, and it can store up to 2,000 different programs of 7 different settings each. The maximum time to auto-adjust between programmed crimp heights is 2 seconds.

The lower cost, manual adjust IIE is a simpler version without CQM capability, with the advantage of faster set-up times.

To avoid the need to change product reels when wire combinations are smaller than the CMA range of the splice, an optional stuffer (part no. 679323-1 for APT IIIA, part no. 679323-2 for APT IIE.) inserts a stuffer wire into the splice prior to crimping, increasing the total CMA to the recommended range. The wire stuffer unit is for pigtail splices only.



APT III A with vertical base (679984-1) for direct connect terminals

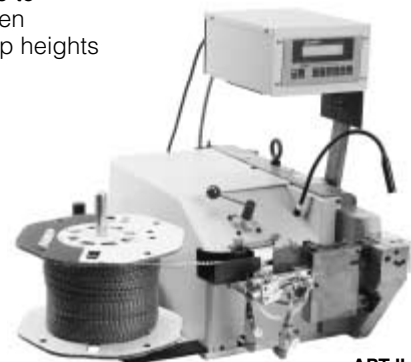

APT IIE

**AMPLIVAR Application Tooling** (Continued)

**AMPLIVAR Product Terminator (APT)** (Continued)

**Machine Ordering Information**

A "Base Part Number" is selected from the Basic Machine Part Numbers table. Then, a dash number or numbers are selected from one of the other two tables depending on the type of product to be applied.

**Note:** The wire stuffer is available for Pigtail-Type Splice only and may be added to the machine after installation.

679323-1 — APT IIIA  
679323-2 — APT IIE

**Basic Machine Part Numbers**

Machine Features			Model	Base Part Number*
Precision Adjust	Crimp Quality Monitor	Programmable Crimp-Height Sequencing		Pigtail-type Splice
Manual	Not included	Not included	APT IIE**	<input type="checkbox"/> -1338906- <input type="checkbox"/>
Automatic	Included	Included	APT IIIA	<input type="checkbox"/> -679453- <input type="checkbox"/>

\*See tables below for suffix and prefix dash numbers which indicate product to be applied, product crimp width, and voltage requirement.

\*\*Not upgradable to an APT IIIA

**AMPLIVAR Pigtail-Type Splice Suffix and Prefix Dash Numbers**

(Aluminum base 679984-1 not included)

Pigtail-type Splice Base Number	Crimp Width	120/240 VAC IIE Machine	120/240 VAC IIIA Machine
		<input type="checkbox"/> -1338906- <input type="checkbox"/>	<input type="checkbox"/> -679453- <input type="checkbox"/>
42775 42776	.110 [2.79]	1-( )-1	3-( )-7
42777 42778	.110 [2.79]	1-( )-2	3-( )-8
42779	.140 [3.56]	( )-8	3-( )-4
62000	.110 [2.79]	1-( )-2	3-( )-8
62001	.140 [3.56]	( )-7	3-( )-3
62001	.180 [4.57]	( )-6	3-( )-2
62201	.140 [3.56]	( )-8	3-( )-4
62002	.180 [4.57]	( )-3	2-( )-9
62040	.110 [2.79]	1-( )-1	3-( )-7
62157 62200	.110 [2.79]	1-( )-2	3-( )-8
62295	.250 [6.35]	( )-1	2-( )-7
62303	.080 [2.03]	1-( )-3	3-( )-9
62304 62305	.110 [2.79]	1-( )-2	3-( )-8
62306	.140 [3.56]	1-( )-0	3-( )-6
62306 62307	.110 [2.79]	1-( )-1	3-( )-7
62308	.140 [3.56]	( )-9	3-( )-5
62308	.180 [4.57]	( )-6	3-( )-2
62309	.220 [5.59]	5-( )-4	5-( )-3
62309	.180 [4.57]	( )-5	3-( )-1
62310	.220 [5.59]	( )-2	2-( )-8
62310	.180 [4.57]	( )-4	3-( )-0
280002	.110 [2.79]	1-( )-1	3-( )-7
280004	.110 [2.79]	1-( )-2	3-( )-8
964156	.110 [2.79]	1-( )-1	3-( )-7

**Pins, Receptacles, Tab and Taper Tab Receptacles Terminals**

**Product Facts**

- Pin terminals are available in .080, .093, .109 and .125 diameters.
- Receptacle terminals are available that accept .032, .040, .050, .055, .062, .090, .093 and .109 pin diameters
- SHUR-PLUG terminals and Receptacle terminals are available in .156 and .180 diameters.
- Tab Receptacle terminals are available that accept tab thicknesses ranging from .010 - .060 and widths ranging from .025 - .250.
- Taper Tab Receptacle terminals are available in 78 Series and 98 Series
- Precision formed, strip-fed pins, receptacles and tab receptacle terminals terminated in AMP automatic machines for high production rates per hour



Tyco Electronics offers a full selection of AMP open barrel pins, receptacles and tab receptacle terminals that are specifically designed to terminate various stranded and solid wire ranges for customer specific application requirements.

Pin terminals are available in .080, .093, .109 and .125 diameters to mate to industry standard or customer specific receptacle terminals. They are designed with and/or without insulation barrel supports, including one with an insulation piercing wire barrel terminate flat wire while others are specifically designed for post overmolding. Depending on your specific application, pin terminals are available for terminations in the 14–30 AWG wire range in brass and tin plated brass material.

Receptacle terminals are available to accept .032, .040, .050, .055, .062, .090, .093 and .109 pin terminal diameters to mate to industry standard or customer specific pin terminal requirements. They are designed with and/or without insulation barrel

supports for terminations ranging from 20–32 AWG stranded or solid wire as well as magnet wire ranging from 29–16 AWG. Some terminals are designed with or without locking feature and others are specifically designed for post overmolding. Receptacle terminals are manufactured in brass and phosphor bronze material with tin, silver and gold plating options available.

SHUR-PLUG terminals and SHUR-PLUG Receptacle terminals that are specifically designed for wiring harnesses used in the truck, bus, marine and off-highway vehicle marketplace. SHUR-PLUG terminals are available in .156 and .180 diameters that accept wire ranging from 24–5 AWG gage. They are available with or without insulation support barrels with various part numbers available for post overmolding and one specifically designed for a weld connection. SHUR-PLUG terminals are manufactured in brass material with tin or tin over nickel plating options available.

Tab Receptacle terminals are available to mate to industry standard and customer specific tab applications. They accept tab thicknesses ranging from .010–.060 in widths ranging from .025–.250. They accept wire ranging from 26–14 AWG and are available with or without insulation support barrels. Tab Receptacles are manufactured in brass and beryllium copper material with tin and gold plated versions available.

Taper Tab Receptacle terminals are available in 78 Series and 98 Series with insulation support. They terminate 24–22 AWG wire in tin plated brass material. The 78 Series insulation piercing terminals are manufactured in brass material with tin, nickel and gold plating options that terminate tinsel wire.

Pins, Receptacles and Tab Receptacle terminals are manufactured in strip form and supplied on reels for semi-automated and fully automated terminations on crimping machines for high output per hour production rates.

**Technical Documents**

Application Specifications describe requirements for using the product in its intended application and/or crimping information. They are intended for the Packaging and Design Engineer and the Machine Setup Person.

- 114-2080** — Pin Receptacle Contacts
- 114-2083** — Pin Receptacle Contact
- 114-2042** — .156 [3.96] Diameter SHUR-PLUG and Receptacle Terminals
- 114-2017** — .180 [4.57] Diameter SHUR-PLUG and Receptacle Terminals

**Product Specifications**

Product Specifications describe the product qualification test results completed by Tyco Electronics for consideration of product use in a specific application. They are intended for the Design and Product Reliability Engineer.

- 108-2027** — .156 [3.96] Diameter SHUR-PLUG and Receptacle terminals

**Pin Terminals**

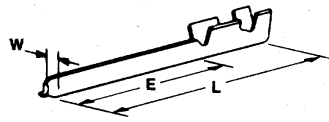

A

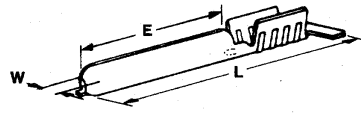

B

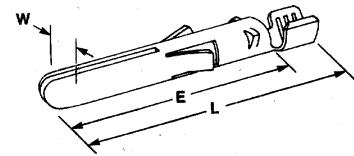

C

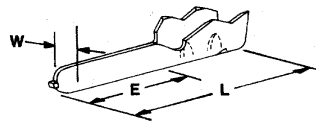

D

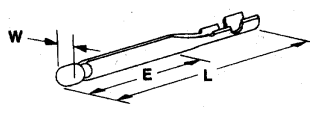

E

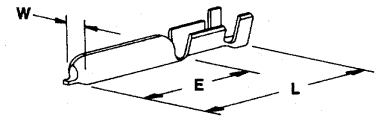

F

Type	Wire Range		Insul. Size	Pin Dia.	Stock Thk.	Material and Finish	Dimensions			Part Number
	AWG	mm <sup>2</sup>					W	L	E	
A	30-26	0.05-0.12	.042-.073 1.07-1.85	.080 2.03	.010 0.25	Tin Plated Brass	.080 2.03	1.280 32.51	1.000 25.40	350053-2
F	24-20	0.2-0.6	.060-.103 1.52-2.62	.125 3.18	.016 0.41	Brass	.125 3.18	.705 17.51	.450 11.43	62074-1
E	24-20	0.2-0.6	.060-.103 1.52-2.62	.125 3.18	.016 0.41	Brass	.125 3.18	.705 17.51	.450 11.43	62344-1
A	24-20	0.2-0.6	.042-.073 1.07-1.85	.080 2.03	.010 0.25	Tin Plated Brass	.080 2.03	1.000 25.40	.720 18.29	62358-1
				.080 2.03	.010 0.25	Br. Tin Lead Plated Brass	.080 2.03	1.000 25.40	.720 18.29	62358-4
E	22-20	0.4-0.6	.075-.090 1.91-2.29	.125 3.18	.016 0.41	Brass	.125 3.18	1.393 35.38	.800 20.32	60115-11
				.125 3.18	.016 0.41	Brass	.125 3.18	1.393 35.38	.800 20.32	60115-41
C	22-18	0.3-0.9	—	.130 3.30	.016 0.41	Brass	.130 3.30	.855 21.72	.660 16.76	62505-1
B	22-16	0.3-1.4	—	.093 2.36	.012 0.31	Tin Plated Brass	.093 2.36	.835 21.21	.652 16.56	62820-11
B	18-14	0.9-2.0	—	.109 2.77	.016 0.41	Tin Plated Brass	.109 2.77	.925 23.50	.500 12.70	61013-2 <sup>1</sup>
				.109 2.77	.016 0.41	Brass	.109 2.77	.920 23.37	.610 15.44	62616-1
D	.085 × .035 2.16 × 0.89	Flat Wire	.085 2.16	.109 2.77	.020 0.51	Brass	.109 2.77	.595 15.11	.350 8.90	61674-1 <sup>2</sup>
				.109 2.77	.020 0.51	Brass	.109 2.77	.595 15.11	.350 8.90	61674-1 <sup>2</sup>

<sup>1</sup> Can be molded.

<sup>2</sup> Insulation Piercing.

**Note:** The part numbers listed are for use with existing machine models. For AMP-O-LECTRIC Model G applicators part numbers, call the Technical Support Center at 1-800-522-6752.

**Receptacle Terminals**

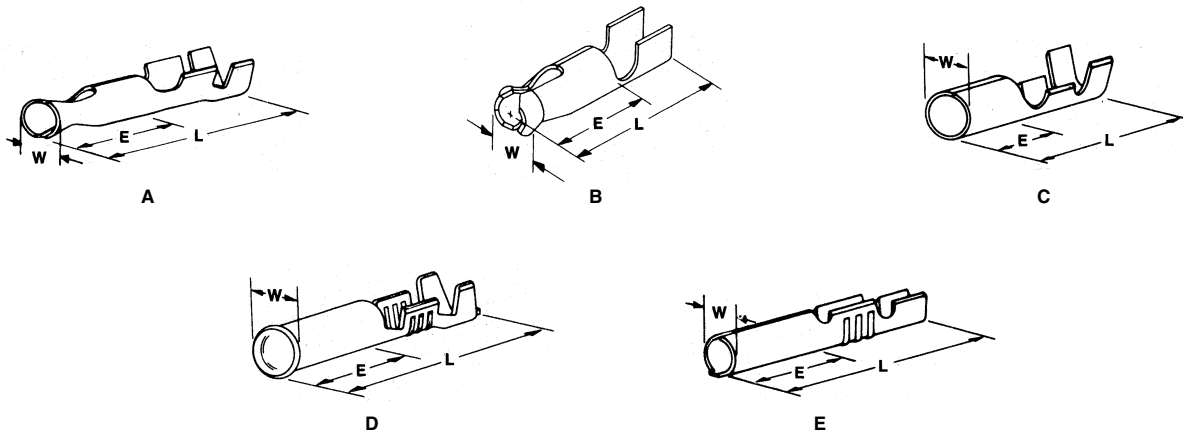

Type	Wire Range		Insul. Size	Pin Dia.	Stock Thk.	Material and Finish	Dimensions			Part Number
	AWG	mm <sup>2</sup>					W	L	E	
C	32-26	0.03-0.15	.060 1.52 Max.	.050	.008	Pre-Tin Plated Phos. Bronze	.070	.330	.150	61547-2
				1.27	0.20		1.78	8.38	3.81	
B	28-26	0.09-0.15	—	.040	.012	Gold Plated Phos. Bronze	.090	.370	.150	62185-1
				1.02	0.31		2.29	9.40	3.81	
				.040	.012	Tin Plated Phos. Bronze	.090	.370	.150	62185-2
				1.02	0.31		2.29	9.40	3.81	
A	24-20	0.2-0.6	.048-.071 1.22-1.8	.040	.012	Tin Plated Phos. Bronze	.095	.450	.220	42428-5 <sup>1</sup>
				1.02	0.31		2.41	11.43	5.59	
				.040	.012	Silver Plated Phos. Bronze	.095	.450	.220	42428-8
				1.02	0.31		2.41	11.43	5.59	
				.050	.012	Tin Plated Phos. Bronze	.090	.360	.220	60348-4
				1.27	0.31		2.29	9.14	5.59	
.032	.012	Tin Plated Phos. Bronze	.095	.450	.220	60373-4				
0.81	0.31		2.41	11.43	5.59					
E	24-20	0.2-0.6	.090-.130 2.27-3.30	.093	.010	Brass	.115	.560	.250	60469-1
			2.36	0.25	2.92		14.23	6.35		
A	24-20	0.2-0.6	.048-.071 1.22-1.80	.055	.013	Gold/Nickel Plated Phos. Bronze	.095	.450	.220	60885-1
				1.40	0.33		2.41	11.43	5.59	
A	24-20	0.2-0.6	.048-.071 1.22-1.80	.055	.013	Tin Plated Phos. Bronze	.095	.450	.220	60885-2 <sup>2</sup>
				1.40	0.33		2.41	11.43	5.59	
D	24-20	0.2-0.6	.070 1.78 Max.	.062 <sup>3</sup>	.010	Pre-Tin Plated Brass	.100	.430	.190	61622-1
			1.57	0.25	2.54		10.92	4.83		

<sup>1</sup> Reverse reel of 42428-2.

<sup>2</sup> Reverse reel of 42429-2.

<sup>3</sup> Or .045 [1.14] square post.

**Note:** The part numbers listed are for use with existing machine models. For AMP-O-LECTRIC Model G applicators part numbers, call the Technical Support Center at 1-800-522-6752.

**Receptacle Terminals** (Continued)

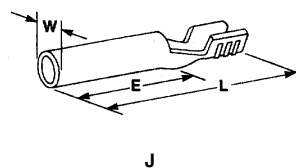
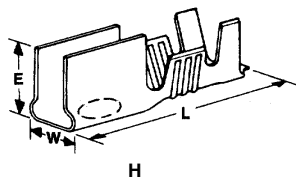
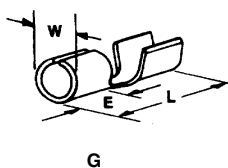
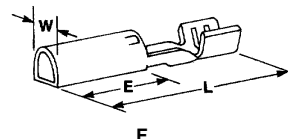
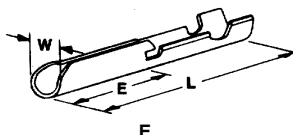
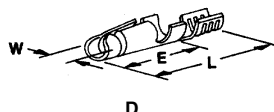
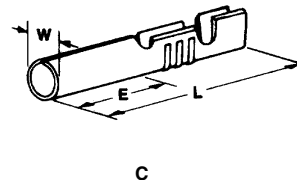
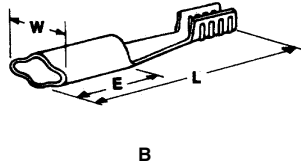
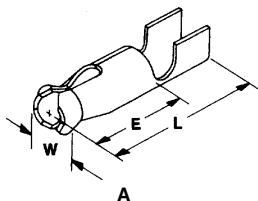

Type	Wire Range		Insul. Size	Pin Dia.	Stock Thk.	Material and Finish	Dimensions			Part Number
	AWG	mm <sup>2</sup>					W	L	E	
A	24-20	0.2-0.6	—	.040	.012	Tin Plated Phos. Bronze	.090	.360	.220	62160-1
				1.02	0.31		2.29	9.14	5.59	42869-6
				.040	.012	Tin Plated Phos. Bronze	.090	.360	.220	2.29
C	24-18	0.2-0.9	.045-.085 1.14-2.16	.093	.012	Tin Plated Brass	.115	.560	.250	42827-2
				2.36	0.31		2.92	14.23	6.35	
E	22-20	0.4-0.6	.075-.100 1.91-2.54	.106	.012	Tin Plated Brass	.150	.690	.360	60908-1
				2.69	0.31		3.81	17.53	9.14	
C	22-18	0.4-0.9	.090-.130 2.29-3.30	.093	.012	Tin Plated Brass	.115	.560	.250	41854
				2.36	0.31		2.92	14.23	6.35	
				.093	.012	Brass	.115	.560	.250	2.92
D	22-18	0.4-0.9	—	.093	.010	Brass	.115	.530	.345	60440-1
				2.36	0.26		2.92	13.46	8.76	
H	22-18	0.4-0.9	.100 2.54 Max.	.093	.012	Tin Plated Brass	.130	.480	.150	60884-3 <sup>1</sup>
E	22-18	0.4-0.9	(2) .060 1.52 Max.	.106	.012	Tin Plated Brass	.150	.690	.360	62402-1 <sup>2</sup>
				2.69	0.31		3.81	17.53	9.14	
F	22-18	0.4-0.9	—	.109	.014	Silver Plated Brass	.133	.585	.250	62720-2 <sup>3</sup>
				2.77	0.36		3.38	14.86	6.35	
				.109	.014	Brass	.133	.585	.250	3.38
J	22-18	0.4-0.9	—	.109	.014	Silver Plated Brass	.133	.585	.250	63594-2
				2.77	0.36		3.38	14.86	6.35	
G	20-18	0.6-0.9	—	.125	.014	Brass	.150	.635	.375	63381-1
				3.18	0.36		3.81	16.13	9.52	
B	20-16	0.6-1.4	—	.119	.016	Brass	.145	.375	.125	40652
				3.02	0.41		3.68	9.53	3.18	
B	20-16	0.6-1.4	—	.090	.018	Tin Plated Phos. Bronze	.235	.660	.255	60733-1 <sup>4</sup>
				2.29	0.46		5.97	16.76	6.48	

<sup>1</sup> Right angle pin entry.

<sup>2</sup> Without ears.

<sup>3</sup> Can be molded.

<sup>4</sup> Corrugated serrations, Can be bent 90°.

**Note:** The part numbers listed are for use with existing machine models. For AMP-O-LECTRIC Model G applicators part numbers, call the Technical Support Center at 1-800-522-6752.

Receptacle Terminals

**Receptacle Terminals** (Continued)

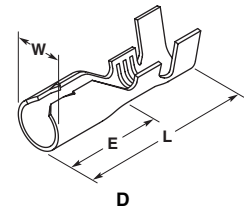
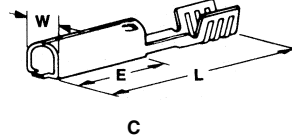
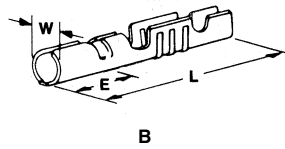
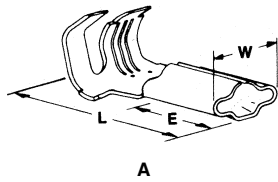

Type	Wire Range		Insul. Size	Pin Dia.	Stock Thk.	Material and Finish	Dimensions			Part Number
	AWG	mm <sup>2</sup>					W	L	E	
A	20-14	0.6-2.0	.120-.170 3.04-4.31	.090	.018	Tin Plated Phos. Bronze	.235	.550	.250	42745-2
				2.29	0.46		5.97	13.97	6.35	
				.090	.018	Tin Plated Phos. Bronze	.235	.550	.250	60376-11
				2.29	0.46		5.97	13.97	6.35	
				.090	.018	Beryllium Copper	.235	.550	.250	60376-21
				2.29	0.46		5.97	13.97	6.35	
B	18-16	0.9-1.4	.090-.120 2.29-3.05	.093	.014	Tin Plated Brass	.115	.560	.150	42101-22
				2.36	0.36		2.92	14.22	3.81	
C	18-14	0.9-2.0	—	.109	.014	Brass	.133	.645	.300	61012-1 <sup>3</sup>
				2.77	0.36		3.38	16.38	7.62	
				.109	.014	Tin Plated Brass	.133	.645	.300	61012-3 <sup>3</sup>
				2.77	0.36		3.38	16.38	7.62	
D	18-14	0.9-2.0	.130-.175 3.30-4.45	#10 Screw	.016	Brass	.212	.690	.250	42308-1
					0.41		5.38	17.53	6.35	

<sup>1</sup> Without locking dimple.

<sup>2</sup> Has locking feature for pin with indent.

<sup>3</sup> Can be molded.

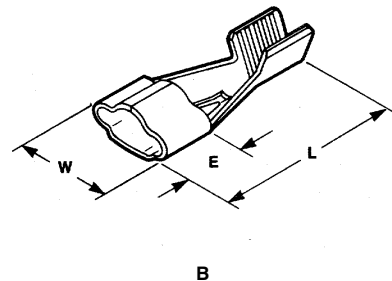
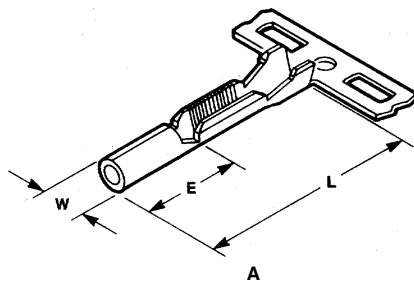

Type	Wire Range		Insul. Size	Pin Dia.	Stock Thk.	Material and Finish	Dimensions			Part Number
	AWG	mm <sup>2</sup>					W	L	E	
A	29-22	0.28-0.64	.040-.060 1.02-1.52	.062	.012	Tin Plated Brass	.084	.590	.195	63506-11
				1.57	0.30		2.13	14.99	4.95	
B	21-16	0.72-1.29	—	.090	.018	Tin Plated Phos. Bronze	.235	.660	.255	60177-21
				2.29	0.46		5.97	16.76	6.48	

<sup>1</sup> Magnet wire.

**Note:** The part numbers listed are for use with existing machine models. For AMP-O-LECTRIC Model G applicators part numbers, call the Technical Support Center at 1-800-522-6752.

**SHUR-PLUG Terminals**

**.156 [3.96] Diameter**

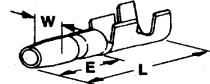

A



B

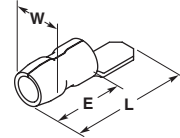

C

Type	Wire Range		Insul. Size	Stock Thk.	Material and Finish	Dimensions			Part Number
	AWG	mm <sup>2</sup>				W	L	E	
A	20-16	0.6-1.4	.095-.115 2.41-2.92	.018 0.46	Pre-Tin Plated Brass	.160 4.06	.710 18.03	.345 8.76	61388-1 <sup>1</sup>
B	18-14	0.9-2.0	.125-.160 3.18-4.06	.020 0.51	Pre-Tin Plated Brass	.157 3.99	.535 13.59	.345 8.76	41698
A	18-14	0.9-2.0	.085-.125 2.16-3.18	.018 0.46	Brass	.160 4.06	.710 18.03	.345 8.76	60766-1 <sup>1</sup>
				.018 0.46	Pre-Tin Plated Brass	.160 4.06	.710 18.03	.345 8.76	60766-2 <sup>1</sup>
B	18-14	0.9-2.0	—	.018 0.46	Pre-Tin Plated Brass	.160 4.06	.500 12.70	.300 7.62	61802-1 <sup>1</sup>
A	18-14	0.9-2.0	.085-.210 2.16-5.33	.018 0.46	Brass	.160 4.06	.710 18.03	.350 8.89	61891-2 <sup>1</sup>
B	12 or (2) 14	3.0 or (2) 2.0	—	.018 0.46	Pre-Tin Plated Brass	.160 4.06	.600 15.24	.300 7.62	63925-1 <sup>1</sup>
B	14-10 or (2) 14	2.0-6.0 or (2) 2.0	—	.018 0.46	Tin Plated Brass	.160 4.06	.625 15.88	.300 7.62	1742039-1
C	Weld Tab		—	.018 0.46	Pre-Tin Plated Brass	.160 4.06	.540 13.72	.300 7.62	62829-1

<sup>1</sup> Can be molded.

**.180 [4.57] Diameter**

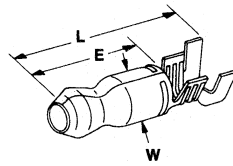

A

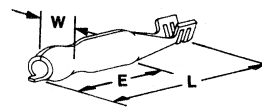

B

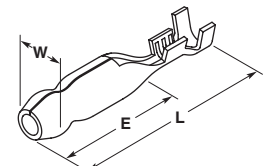

C

Type	Wire Range		Insul. Size	Stock Thk.	Material and Finish	Dimensions			Part Number
	AWG	mm <sup>2</sup>				W	L	E	
C	24-22	0.2-0.4	.058-.082 1.47-2.08	.018 0.46	Tin/Nickel Plated Brass	.180 4.57	.885 22.48	.435 11.05	62416-1 <sup>1</sup>
				.018 0.46	Tin/Nickel Plated Brass	.180 4.57	.865 21.97	.435 11.05	1217104-11 <sup>2</sup>
	20-16	0.6-1.4	.090-.125 2.29-3.18	.018 0.46	Brass	.180 4.57	.740 18.80	.447 11.35	505038-1 <sup>1</sup>
A	18-14	0.9-2.0	.090-.125 2.29-3.18	.018 0.46	Tin Plated Brass	.180 4.57	.740 18.80	.447 11.35	60793-1 <sup>1</sup>
				.018 0.46	Tin Plated Brass	.180 4.57	.740 18.80	.447 11.35	62739-1 <sup>1</sup>
			.120-.175 3.05-4.45	.018 0.46	Tin Plated Brass	.180 4.57	.740 18.80	.447 11.35	60660-1 <sup>1</sup>
				.018 0.46	Brass	.180 4.57	.740 18.80	.447 11.35	60660-2 <sup>1</sup>
				.018 0.46	Brass	.180 4.57	.855 21.72	.435 11.05	42865-1 <sup>1</sup>
	14-10	2.0-6.0	—	.018 0.46	Tin Plated Brass	.180 4.57	.855 21.72	.435 11.05	42865-3 <sup>1</sup>
B				.018 0.46	Tin/Nickel Plated Brass	.180 4.57	.855 21.72	.435 11.05	42865-5 <sup>1</sup>
				.018 0.46	Pre-Tin Plated Brass	.180 4.57	.865 21.97	.435 11.05	63989-1 <sup>1</sup>
	12-8	3.0-8.0	—	.030 0.76	Tin Plated Brass	.180 4.57	1.555 34.50	1.080 27.43	1217142-1 <sup>1</sup>
	(2) 8	(2) 8.0	—	.030 0.76	Tin Plated Brass	.180 4.57	1.555 34.50	1.080 27.43	1217185-1 <sup>1</sup>

<sup>1</sup> Can be molded.

<sup>2</sup> Loose piece.

**Note:** The part numbers listed are for use with existing machine models. For AMP-O-LECTRIC Model G applicators part numbers, call the Technical Support Center at 1-800-522-6752.



**SHUR-PLUG Receptacle Terminals**

**.156 [3.96] Diameter**

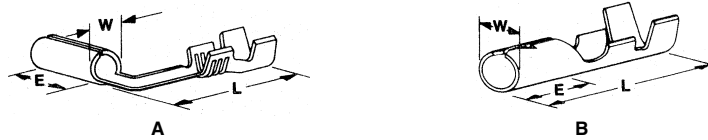

Type	Wire Range		Insul. Size	Stock Thk.	Material and Finish	Dimensions			Part Number
	AWG	mm <sup>2</sup>				W	L	E	
B	22-18	0.4-0.9	.085-.125 2.16-3.18	.016 0.41	Tin Plated Brass	.190 4.83	.690 17.53	.250 6.35	42581-2
A	20-16	0.6-1.4	.100-.140 2.54-3.56	.016 0.41	Brass	.190 4.83	.705 17.91	.370 9.40	60017-3
B	18-14	0.9-2.0	.130-.175 3.30-4.45	.016 0.41	Tin Plated Brass	.190 4.83	.690 17.53	.345 8.76	42142-1
				.016 0.41	Brass	.190 4.83	.690 17.53	.345 8.76	42142-2
				.016 0.41	Tin Plated Brass	.190 4.83	.695 17.65	.345 8.76	63865-1 <sup>1</sup>

<sup>1</sup> No indent.

**.180 [4.57] Diameter**

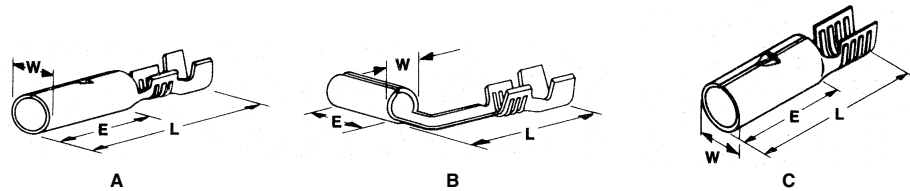

Type	Wire Range		Insul. Size	Stock Thk.	Material and Finish	Dimensions			Part Number	
	AWG	mm <sup>2</sup>				W	L	E		
A	20-16	0.6-1.4	.090-.120 2.29-3.05	.016 0.41	Brass	.208 5.28	.785 19.94	.420 10.67	42531-1	
				.016 0.41	Tin Plated Brass	.208 5.28	.785 19.94	.420 10.67	42531-2	
B	20-16	0.6-1.4	.100-.140 2.54-3.56	.016 0.41	Brass	.208 5.28	.715 18.16	.360 9.14	42700-1	
				.016 0.41	Brass	.208 5.28	.715 18.16	.360 9.14	42700-3 <sup>2</sup>	
				.016 0.41	Brass	.208 5.28	.785 19.94	.420 10.67	60798-2	
				.016 0.41	Tin Plated Brass	.208 5.28	.785 19.94	.420 10.67	60798-4	
A	18-14	0.9-2.0	.090-.125 2.29-3.18	.016 0.41	Brass	.208 5.28	.785 19.94	.420 10.67	60799-2 <sup>1</sup>	
				.016 0.41	Pre-Tin/Nickel Plated Phos. Bronze	.208 5.28	.785 19.94	.420 10.67	60799-4 <sup>1</sup>	
				.016 0.41	Tin Plated Brass	.208 5.28	.785 19.94	.420 10.67	60799-5 <sup>1</sup>	
				.016 0.41	Brass	.208 5.28	.785 19.94	.420 10.67	61412-1	
				.016 0.41	Tin Plated Brass	.208 5.28	.785 19.94	.420 10.67	61412-2	
				.016 0.41	Brass	.208 5.28	.720 18.29	.420 10.67	42868-1	
C	14-10	2.0-6.0	—	.016 0.41	Tin Plated Brass	.208 5.28	.720 18.29	.420 10.67	42868-2	
				.016 0.41	Brass	.208 5.28	.720 18.29	.420 10.67	42891-1 <sup>1</sup>	
				.016 0.41	Tin Plated Brass	.208 5.28	.720 18.29	.420 10.67	42891-2 <sup>1</sup>	
	(2) 8	(2) 8.0	—	—	.016 0.41	Tin Plated Brass	.208 5.28	.720 18.29	.420 10.67	1217070-1
					.016 0.41	Brass	.208 5.28	.770 19.56	.420 10.67	1217074-1
					.016 0.41	Tin Plated Brass	.208 5.28	.770 19.56	.420 10.67	1217074-2

<sup>1</sup> No indent.

<sup>2</sup> Reverse reel of Part Number 42700-1.

**Note:** The part numbers listed are for use with existing machine models. For AMP-O-LECTRIC Model G applicators part numbers, call the Technical Support Center at 1-800-522-6752.

**Tab Receptacle Terminals**

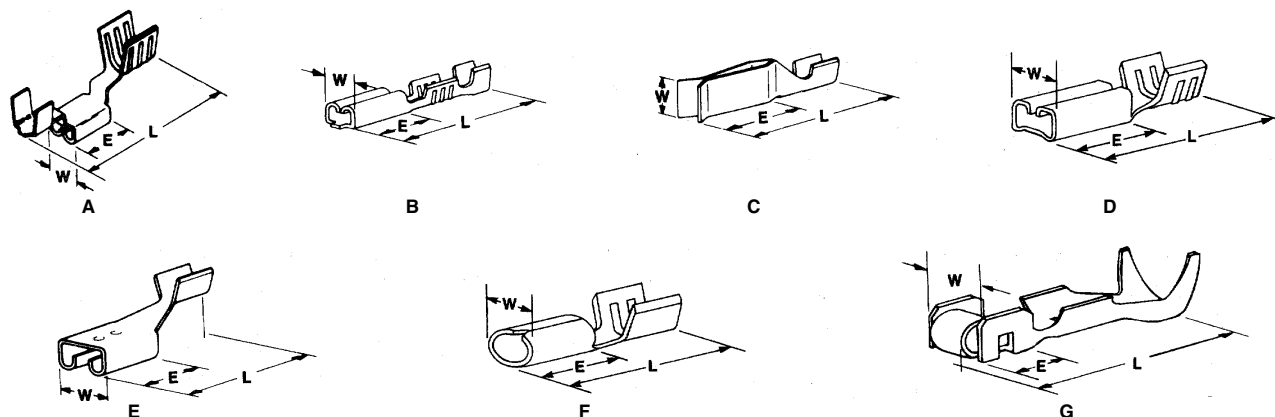

Type	Wire Range		Insul. Dia. Range	Stock Thk.	Material and Finish	Fits Tab	Dimensions			Part Number
	AWG	mm <sup>2</sup>					W	L	E	
B	26-22	0.12-0.4	.035-.065 0.89-1.65	.010 0.25	Pre-Tin Brass	.031 × .093 0.79 × 2.36	.120 3.05	.475 12.06	.190 4.83	61813-1 <sup>6</sup>
				.010 0.25	Pre-Tin Brass	.014 × .093 0.36 × 2.36	.120 3.05	.475 12.06	.190 4.83	62041-17
G	26-22	0.12-0.4	.035-.060 0.89-1.52	.008 0.20	Gold Plated Beryllium Copper	.025 × .025 0.64 × 0.64	.085 2.16	.390 9.91	.090 2.29	61941-1
				.010 0.25	Brass	.045 × .045 1.14 × 1.14	.095 2.41	.372 9.45	.130 3.30	60524-1
A	24-20	0.2-0.6	.040-.080 1.02-2.03	.010 0.25	Gold Plated Brass	.045 × .045 1.14 × 1.14	.095 2.41	.372 9.45	.130 3.30	60524-3
				.010 0.25	Tin Plated Beryllium Copper	.045 × .045 1.14 × 1.14	.095 2.41	.372 9.45	.130 3.30	60524-5
				.010 0.25	Gold Plated Brass	.031 × .062 0.79 × 1.57	.090 2.29	.372 9.45	.130 3.30	60477-1
				.010 0.25	Tin Plated Brass	.023 × .062 0.58 × 1.57	.090 2.29	.372 9.45	.130 3.30	60436-2
B	24-20	0.2-0.6	.040-.080 1.02-2.03	.010 0.25	Tin Plated Brass	.031 × .062 0.79 × 1.57	.090 2.29	.462 11.73	.187 4.75	60900-11
				.010 0.25	Gold Plated Brass	.031 × .062 0.79 × 1.57	.090 2.29	.462 11.73	.187 4.75	60900-2
				.010 0.25	Tin Plated Brass	.031 × .062 0.79 × 1.57	.090 2.29	.462 11.73	.187 4.75	60900-4 <sup>2</sup>
				.010 0.25	Gold Plated Brass	.031 × .062 0.79 × 1.57	.090 2.29	.462 11.73	.187 4.75	60900-5 <sup>8</sup>
F	24-20	0.2-0.6	—	.010 0.25	Tin Plated Brass	.015 × .050 0.38 × 1.27	.070 1.78	.310 7.87	.145 3.68	62352-1
				.010 0.25	Tin Plated Brass	.037 × .125 0.94 × 3.18	.160 4.06	.425 10.80	.190 4.83	41989
A	22-18	0.3-0.9	.060-.110 1.52-2.79	.010 0.25	Tin Plated Brass	.031 × .062 0.79 × 1.57	.090 2.29	.372 9.45	.130 3.30	61489-1
				.010 0.25	Gold Plated Brass	.031 × .062 0.79 × 1.57	.090 2.29	.372 9.45	.130 3.30	61616-1
B	22-18	0.3-0.9	.050-.085 1.27-2.16	.010 0.25	Pre-Tin Brass	.010 × .093 0.25 × 2.36	.120 3.05	.480 12.19	.190 4.83	63391-14 <sup>5</sup>
				.010 0.25	Pre-Tin Brass	.010 × .093 0.25 × 2.36	.120 3.05	.480 12.19	.190 4.83	63391-2 <sup>5</sup>
	20-18	0.5-0.9	.080-.120 2.03-3.05	.010 0.25	Pre-Tin Brass	.032 × .103 0.81 × 2.62	.126 3.20	.480 12.19	.200 5.08	60252-17
				.010 0.25	Pre-Tin Brass	.020 × .103 0.51 × 2.62	.126 3.20	.480 12.19	.200 5.08	60432-17
D	20-18	0.5-0.9	—	.010 0.25	Tin Plated Brass	.020 × .156 0.51 × 3.96	.179 4.55	.480 12.19	.200 5.08	62399-1
				.010 0.25	Brass	.010 × .110 0.25 × 2.79	.148 3.76	.380 9.65	.200 5.08	62589-1
E	20-16	0.5-1.3	—	.010 0.25	Tin Plated Brass	.032 × .125 0.81 × 3.18	.160 4.06	.330 9.65	.090 2.29	63615-1
C	18-14	0.8-2.0	—	.025 0.64	Brass	.060 × .250 1.52 × 6.35	.250 6.35	.985 25.02	.520 13.20	60312-1

<sup>1</sup> Available in Loose Piece form, order Part No. 61454-1.  
<sup>2</sup> Reverse reel of 60900-1.

<sup>3</sup> Loose Piece form, of Part No. 60900-1.  
<sup>4</sup> Loose Piece form, of Part No. 63391-2.

<sup>5</sup> Compliant base.  
<sup>6</sup> No Dimple.

<sup>7</sup> Dimple.  
<sup>8</sup> Reverse reel of 60900-2.

Tab Receptacle Terminals

**Taper Tab Receptacle Terminals**

Precision formed taper tab receptacles are available to mate with tabs having front end dimensions of .078 [1.98] and .098 [2.49]. These receptacles are available in strip form, reel fed for high speed automatic machine termination.

**Taper Tab Specifications**

Difference between these two dimensions must be held from .0115 to .0125 [0.29 to 0.32]

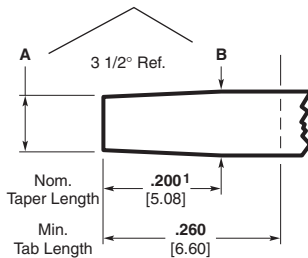

<sup>1</sup> Intersection must be clean no offset and no increase in taper (both sides) over this length.

**78 Series**

**A** =  $.078 \pm .001$   
[1.98 ± 0.03]

**B** =  $.090 \pm .001$   
[2.29 ± 0.03]

**Tab Thickness** —  $.023/.016$   
[0.58/0.41]

**98 Series**

**A** =  $.098 \pm .001$   
[2.49 ± 0.03]

**B** =  $.110 \pm .001$   
[2.79 ± 0.03]

**Tab Thickness** —  $.025/.016$   
[0.64/0.41]

**78 Series—Insulation Support**

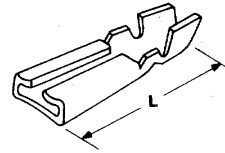

Wire Range		Insul. Dia. Range	Dim. L	Finish	Strip Form Part Number	
AWG	mm <sup>2</sup>				For Use With Standard Appl.	For Use With Miniature Appl.
24-22	0.2-0.4	.030-.050 0.76-1.27	.500 12.70	Tin	—	42765-1

**78 Series—Insulation Piercing**

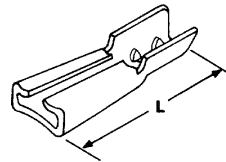

Wire Range		Insul. Dia. Range	Dim. L	Finish	Strip Form Part Number	
AWG	mm <sup>2</sup>				For Use With Standard Appl.	For Use With Miniature Appl.
Tinsel	—	.065-.075 1.65-1.91	.366 9.30	Gold	60442-1	—
Tinsel	—	.065-.075 1.65-1.91	.366 9.30	Nickel	60442-2	—
Tinsel	—	.065-.075 1.65-1.91	.500 12.70	Tin	42519-1	—

**98 Series—Insulation Support**

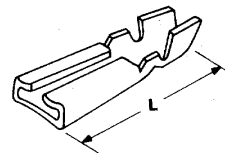

Wire Range		Insul. Dia. Range	Dim. L	Finish	Strip Form Part Number	
AWG	mm <sup>2</sup>				For Use With Standard Appl.	For Use With Miniature Appl.
24-22	0.2-0.4	.040-.060 1.02-1.52	.562 14.27	Tin	—	60891-1

**Contact and Welding Tab Terminals**

**Product Facts**

- **Welding Tab terminals available for 26 -14 AWG lead wire**
- **Brush contacts available for 24-14 AWG lead wire**
- **Button contacts available for 20-16 AWG lead wire**
- **Grounding clip terminals accept .019 - .071 panel thicknesses**
- **Non-insulated Wire Pins available for lead wires ranging from 10 to 22 AWG lead wire**
- **Non-insulated Wire Pins available for magnet wire leads ranging from 13-27 AWG**
- **Precision formed, strip-fed terminals terminated in AMP automatic machines for high production rates per hour**

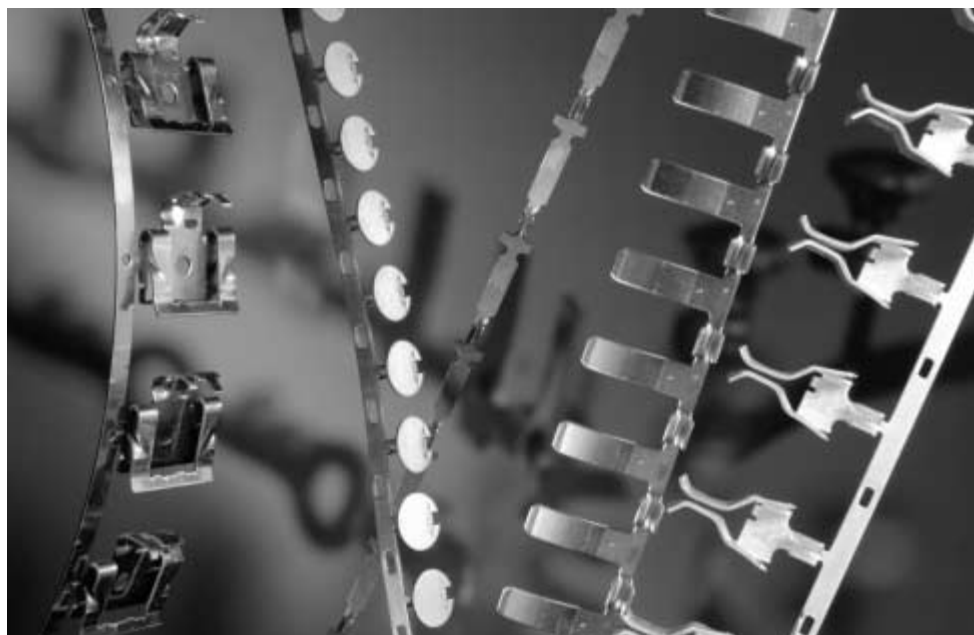

**Technical Documents**

Application Specifications describe requirements for using the product in its intended application and or crimping information. They are intended for the Packaging and Design Engineer and the Machine Setup Person.

**114-2093** — Carbon Brush Contacts

**114-2129** — Grounding Clip

**Product Specifications**

Product Specifications describe the product qualification test results completed by Tyco Electronics for consideration of product use in a specific application. They are intended for the Design and Product Reliability Engineer.

**108-1376** — Grounding Clip

Tyco Electronics offers a full selection of AMP open barrel miscellaneous contact and welding tab terminals that are specifically designed to terminate various stranded and solid lead wire ranges for customer specific application requirements.

Welding tab terminals are available with and without insulation support barrels that terminate 26-14 AWG lead wire. They are manufactured in brass, phosphor bronze and steel material with tin, nickel and gold plating options available.

Brush contacts are manufactured without insulation support barrels, one part number being the exception, that terminate 24-14 AWG lead wire. They are manufactured in brass and phosphor bronze material with silver plating as an option.

Button contacts are available with and without insulation support barrels that terminate 20 -16 AWG lead wire. They are manufactured in brass material with tin plated versions available as well.

Grounding clip terminals are available that can be terminated to 22-14 AWG lead wire and accept panel thickness ranging from .019-.071. They are designed to pierce through enameled painted sheet metal panels in the appliance and lighting industry. They are manufactured out of stainless steel or tin plated phosphor bronze and steel material.

Special Tab Receptacles are available without insulation support barrels that can be terminated to 20-16 AWG lead wire. They are manufactured in brass, phosphor bronze and steel with tin and silver plated version available.

A Plug Blade terminal is featured and readily available to terminate 20-18 AWG lead wire in brass material.

Fuse terminals are available for .250 [6.5] diameters without insulation support that can be terminated to 22-10 AWG lead wire. They are manufactured in brass material with tin plated brass as an option.

Wire Strain Relief Clamps are available for insulation diameters ranging from .150-.310. They are manufactured in aluminum, phosphor bronze and tin plated steel.

A .250 Spark Plug Receptacle is available that is manufactured in nickel plated steel.

A Thermal Protector Crimp Pin is featured that can be terminated directly to a thermal protector open barrel that will accept 16-14 lead wire. The terminal is manufactured in tin plated brass.

Non-insulated Wire Pins are readily available for lead wires ranging from 10 to 22 AWG lead wire. They are manufactured in copper zinc with pre-plated and post plated tin and silver plated versions options listed. Nickel plated steel terminals are also featured.

Non-insulated AMPLIVAR Wire Pins with insulation supports are available to terminate directly to magnet wire leads ranging from 13-27 AWG. They are manufactured in brass with pre-plated and post tin plated versions available.

**Contact and Welding Tab Terminals** (Continued)

**Miscellaneous Contacts and Weld Tabs**

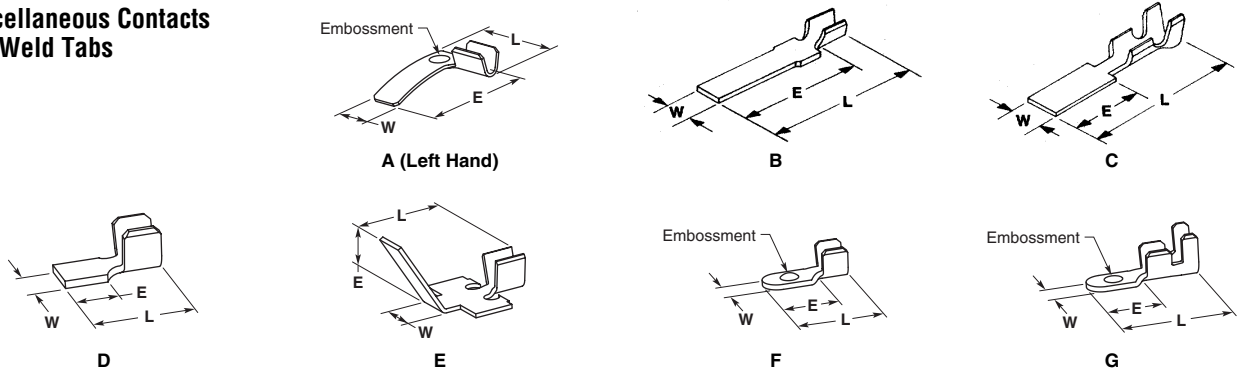

Type	Wire Range		Insul. Dia.	Stock Thickness	Dimensions			Tab Direction	Material	Part Number
	AWG	mm <sup>2</sup>			W	L	E			
A	18-14	0.8-2.0	—	.020 0.51	.155	.340	.390	L.H. R.H.	Phosphor Bronze Phosphor Bronze	42920-3 <sup>4</sup>
					3.94	8.64	9.91			42920-4 <sup>4</sup>
B	22-18	0.3-0.9	—	.016 0.41	.140	.740	.615	—	Brass Tin Plated Brass Brass	155386-11. <sup>6</sup>
					3.56	18.80	15.62			155386-21. <sup>6</sup>
					155386-31. <sup>7</sup>					
C	26-22	0.2-0.4	—	.008 0.20	.115	.600	.470	—	Stainless Steel	62827-1
					2.92	15.24	11.94			
D	18-14	0.8-2.0	—	.012 0.30	.090	.365	.100	—	Nickel Plated Steel	62062-1
					2.29	9.27	2.54			
E	18-14	0.8-2.0	—	.008 0.20	.115	.685	.375	—	Stainless Steel	61263-1
					2.92	17.40	9.53			
F	20-16	0.5-1.4	—	.016 0.41	.140	.540	.345	—	Brass	42349-1 <sup>2</sup>
					3.56	13.72	8.76			
G	20-16	0.5-1.4	—	.020 0.51	.125	.270	.175	—	Tin Plated Steel Nickel Plated Steel Tin Plated Steel	62153-1 <sup>3</sup>
					3.18	6.86	4.45			63701-1 <sup>4</sup>
G	20-16	0.5-1.4	.090-.130 2.29-3.30	.020 0.51	.125 3.18	.365 9.27	.165 4.19	—	Gold Plated Steel Tin Plated Steel Tin Plated Steel	40990-1 <sup>4</sup>
										40990-2 <sup>5</sup>
										60581-1 <sup>5</sup>
										1217510-1 <sup>3</sup>

1 .062 [1.57] diameter hole in tab.  
 2 Tab bent up 60° in applicator.  
 3 Tab embossment up.  
 4 Tab embossment down.  
 5 No tab embossment.  
 6 Standard applicator reeling.  
 7 Mini applicator reeling.

**Contact and Welding Tab Terminals** (Continued)

**Brush Contacts**

Contact and Welding Tab Terminals

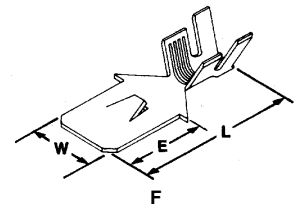
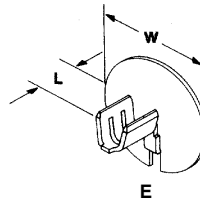
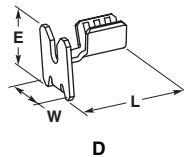
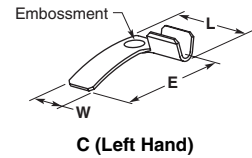
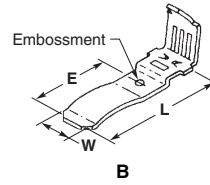
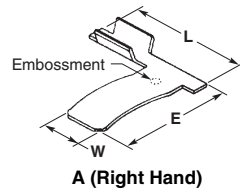

Type	Wire Range		Insul. Dia.	Stock Thickness	Dimensions			Tab Direction	Material	Part Number
	AWG	mm <sup>2</sup>			W	L	E			
A	22-17 Magnet Wire	0.3-1.0 Magnet Wire	—	.020 0.51	.215	.425	.425	L.H.	Phosphor Bronze	62214-1
					5.46	10.80	10.80	R.H.	Phosphor Bronze	62214-2
	18-14	0.8-2.0	—	.020 0.51	.187	.435	.640	R.H.	Phosphor Bronze	60812-1
					4.75	11.05	16.25	L.H.	Phosphor Bronze	60812-2
					.125			R.H.	Phosphor Bronze	350010-1
					3.18					
B	20-14	0.5-2.0	—	.018 0.46	.187	.620	.425	R.H.	Phosphor Bronze	62008-11
					4.75	15.75	10.80		Silver Plated Ph Bz	62008-2 <sup>1</sup>
								L.H.	Phosphor Bronze	62009-11
									Silver Plated Ph Bz	62009-2 <sup>1</sup>
C	20-18	0.5-0.8	—	.012 0.30	.125	.330	.305	R.H.	Phosphor Bronze	63182-1 <sup>1</sup>
					3.18	8.38	7.75	L.H.	Phosphor Bronze	63183-1 <sup>1</sup>
D	20-16	0.5-1.4	—	.018 0.46	.240	.275	.240	—	Brass	61524-2 <sup>2</sup>
					6.10	6.98	6.10			
	24-20	0.2-0.6	—	.016 0.41	.285	.210	—	—	Brass	61933-1 <sup>2</sup>
					7.24	5.33				
					.312	.185	—	—	Brass	63020-1 <sup>2</sup>
					7.29	4.70				
20-16	0.5-1.4	—	.018 0.46	.285	.210	—	—	Brass	1217507-1 <sup>2</sup>	
				7.24	5.33					
E	20-16	0.5-1.4	—	.016 0.41	.360	.185	—	—	Brass	63930-1 <sup>2</sup>
					9.14	4.70				
F	18-14	0.8-2.0	.110-.160 2.79-4.06	.016 0.41	.255	.775	.355	—	Brass	61390-1
					6.48	19.69	9.02			

<sup>1</sup> Tab lock crimp.

<sup>2</sup> Carbon brush application equipment available.

**Miscellaneous Terminals**

**Button Contacts**

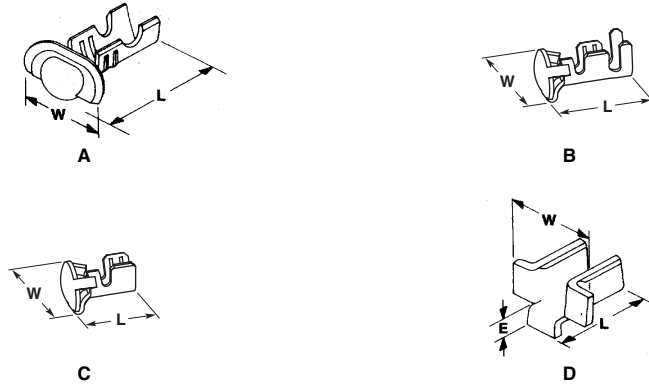

Type	Wire Range		Insul. Dia.	Stock Thickness	Dimensions			Material	Part Number
	AWG	mm <sup>2</sup>			W	L	E		
A	20-16	0.5-1.4	.090-.120 2.29-3.05	.016 0.41	.195	.240	—	Brass	42218-3 <sup>1</sup>
					4.95	6.10			61165-1 <sup>2</sup>
									61165-2 <sup>2</sup>
B	20-16	0.5-1.4	.090-.125 2.29-3.18	.016 0.41	.195	.310	—	Brass	61039-1
					4.95	7.87			505034-1
									505034-2 <sup>2</sup>
					.240	6.10			505034-3 <sup>2</sup>
									61280-1
C	20-16	0.5-1.4	—	.016 0.41	.195	.235	—	Brass	61280-2 <sup>2</sup>
					4.95	5.97			
D	20-16	0.5-1.4	—	.020 0.51	.230	.175	.060 <sup>3</sup>	Brass	40662 <sup>3</sup>
					5.84	4.45	1.52		

<sup>1</sup> fits .150 [3.81] dia hole  
<sup>2</sup> alternate reeling direction for mini applicator compatibility  
<sup>3</sup> tab bent down in applicator

**Grounding Clips**

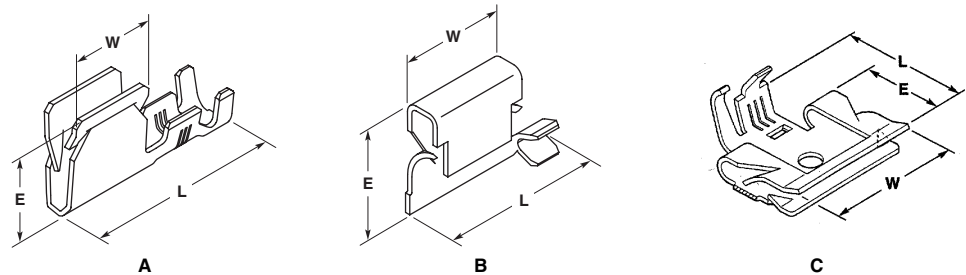

Type	Wire Range		Insul. Dia. Range	Application Panel Thk.	Stock Thk.	Dimensions			Material	Part Number
	AWG	mm <sup>2</sup>				W	L	E		
A	18-14	0.8-2.0	.090-.125 2.29-3.18	.020-.030 0.51-0.76	.020 0.51	.140	.730	.382	Stainless Steel	63895-1
						3.56	18.54	9.70		1217012-1
B	22-18	0.3-0.8	—	.020-.040 0.51-1.02	.020 0.51	.140	.620	.440	Tin Plated Steel	63733-1
						3.56	15.75	11.18		63733-2
C	18-14	0.8-2.0	.100-.140 2.54-3.56	.019-.071 0.48-1.80	.020 0.51	.615	.675	.440	Stainless Steel	63575-1
						15.62	17.10	11.18		

**Miscellaneous Terminals**

**Tab Receptacles — Special**

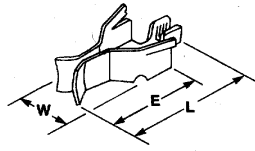

**A**  
Twist Lock Receptacle

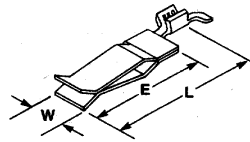

**B**  
Receptacle, 250 Series

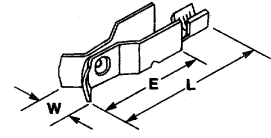

**C**  
Receptacle

Type	Wire Range		Insul. Dia.	Stock Thickness	Dimensions			Material	Part Number
	AWG	mm <sup>2</sup>			W	L	E		
A	20-16	0.5-1.4	—	.025 0.64	.320 8.13	.905 23.00	.665 16.89	Tin Plated Phos Bz	63035-1
	18-14	0.8-2.0						Tin Plated Phos Bz	63863-1
								Silver Plated Phos Bz	63863-2
B	20-16	0.5-1.4	—	.025 0.64	.200 5.08	.995 25.27	.790 20.06	Brass	62281-1
C	20-16	0.5-1.4	—	.025 0.64	.270 6.86	1.000 25.40	.750 19.05	Tin Plated Steel	62727-1
								Tin Plated Steel	63723-1 <sup>1</sup>
								Tin Plated Phos Bz	63723-2 <sup>1</sup>

<sup>1</sup> Includes locking feature similar to style A.

**Plug Blade**

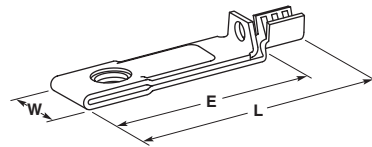

**A**

Type	Wire Range		Insul. Dia.	Stock Thickness	Dimensions			Material	Part Number
	AWG	mm <sup>2</sup>			W	L	E		
A	20-18	0.5-0.9	—	.020 0.51	.250 6.35	.995 25.27	.845 21.46	Brass	156523-1

**Fuse Receptacles —  
.250 [6.35] Dia.**

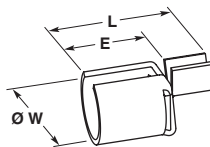

**A**

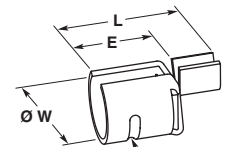

**B**

Type	Wire Range		Insul. Dia.	Stock Thickness	Dimensions			Material	Part Number
	AWG	mm <sup>2</sup>			W	L	E		
A	22-18	0.3-0.9	—	.020 0.51	.250 6.35	.475	.310 7.87	Tin Plated Brass	505020-2
	16-14	1.3-2.0				12.07		Tin Plated Brass	40626
	12-10	3.0-6.0				.495 12.57		Tin Plated Brass	62587-1
B	22-18	0.3-0.9	—	.020 0.51	.250 6.35	.475 12.07	.310 7.87	Brass	1217881-1
	16-14	1.3-2.0						Tin Plated Brass	60654-1
								Brass	60654-2



**Miscellaneous Terminals** (Continued)

**Wire Strain Relief Clamps**

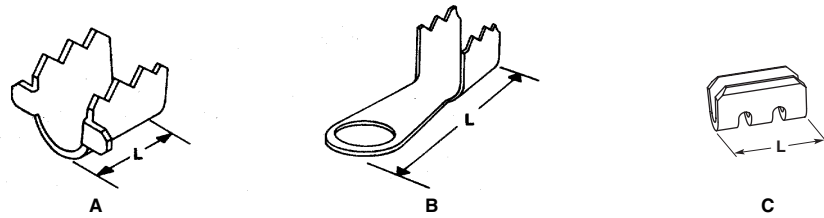

Type	Wire Range		Insul. Dia.	Stock Thickness	Dimensions			Material	Part Number
	AWG	mm <sup>2</sup>			W	L	E		
A	—	—	.180-.230 4.57-5.84	.025 0.64	.575 14.60	.405 10.29	—	Aluminum	42412-5
			.150-.200 3.81-5.08	.028 0.71	.500 12.70	.250 6.35	—	Tin Plated Steel	61831-1
			.290-.310 7.37-7.87	.040 1.02	.640 16.26	—	—	Tin Plated Steel	61987-1
B	—	—	.180-.230 4.57-5.84	.025 0.64	.285 7.24	.750 19.05	—	Aluminum	61520-1 <sup>1</sup>
C	—	—	—	.030 0.76	—	.345 8.76	—	Phosphor Bronze	1217440-8 <sup>2</sup>

<sup>1</sup> Ring .200 [5.08] hole diameter.  
<sup>2</sup> Strain relief for .045 [1.14] dia. stranded steel cable.

**Spark Plug Receptacle —  
.250 [6.35] Dia.**

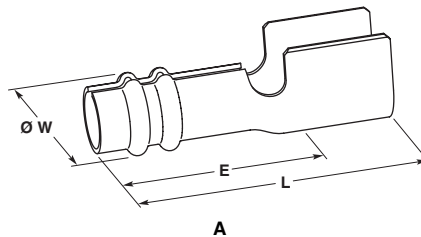

Type	Wire Range		Insul. Dia.	Stock Thickness	Dimensions			Material	Part Number
	AWG	mm <sup>2</sup>			W	L	E		
A	—	—	.275 7.00	.018 0.46	.320 8.13	1.155 29.34	.745 18.92	Nickel Plated Steel	40800

**Thermal Protector Crimp Pin**

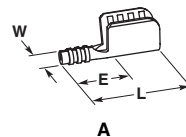

Type	Wire Range		Insul. Dia.	Stock Thickness	Dimensions			Material	Part Number
	AWG	mm <sup>2</sup>			W	L	E		
A	16-14	1.3-2.0	—	.016 0.41	.050 1.27	.375 9.53	.175 4.45	Tin Plated Brass	1217569-11

<sup>1</sup> Pin is crimped in thermal protector wire barrel.

**Miscellaneous Terminals** (Continued)

**Wire Pins**

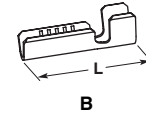
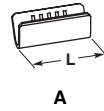

Type	Wire Range		Insul. Dia.	Stock Thickness	Dim. L	Material and Finish	Part Number
	AWG	mm <sup>2</sup>					
A	20-17	0.5-1.0	—	.013 0.32	.276 7.00	Brass	926823-1
						Pre-Tin Plated Brass	926823-2
						Brass	926823-3 <sup>1</sup>
						Pre-Tin Plated Brass	926823-4 <sup>1</sup>
						Phos. Bronze	926823-5
	20-17	0.5-1.0	—	.013 0.32	.276 7.00	Pre-Tin Plated Phos. Bronze	926823-6
						Phos. Bronze	926823-7 <sup>1</sup>
						Pre-Tin Plated Phos. Bronze	926823-8 <sup>1</sup>
	17-13½	1.0-2.5	—	.013 0.32	.276 7.00	Brass	926824-1
						Pre-Tin Plated Brass	926824-2
						Brass	926824-3 <sup>1</sup>
	17-13½	1.0-2.5	—	.013 0.32	.276 7.00	Pre-Tin Plated Brass	926824-4 <sup>1</sup>
Phos. Bronze						926824-5	
Pre-Tin Plated Phos. Bronze						926824-6	
17-13½	1.0-2.5	—	.013 0.32	.276 7.00	Phos. Bronze	926824-7 <sup>1</sup>	
					Pre-Tin Plated Phos. Bronze	926824-8 <sup>1</sup>	
					Nickel Plated Brass	926824-9 <sup>1</sup>	
17-13½	1.0-2.5	—	.013 0.32	.276 7.00	Nickel Plated Brass	1-926824-0	
					Brass	925667-1	
B	22-18	0.30-0.82	.079-.098 2.00-2.50	.013 0.32	.429 10.90	Pre-Tin Plated Brass	925667-2
						Nickel Plated Steel	925667-4
	22-18	0.30-0.82	.079-.098 2.00-2.50	.013 0.32	.429 10.90	Brass	925667-5 <sup>1</sup>
						Pre-Tin Plated Brass	925667-6 <sup>1</sup>
	22-18	0.30-0.82	.079-.098 2.00-2.50	.013 0.32	.429 10.90	Nickel Plated Steel	925667-8 <sup>1</sup>
						Brass	925552-1
	20-17	0.5-1.0	.071-.130 1.80-3.30	.013 0.32	.429 10.90	Pre-Tin Plated Brass	925552-2
						Nickel Plated Steel	925552-4
	20-17	0.5-1.0	.071-.130 1.80-3.30	.013 0.32	.429 10.90	Brass	925552-5 <sup>1</sup>
						Pre-Tin Plated Brass	925552-6 <sup>1</sup>
	20-17	0.5-1.0	.071-.130 1.80-3.30	.013 0.32	.429 10.90	Nickel Plated Steel	925552-8 <sup>1</sup>
						Pre-Tin Plated Phos. Bronze	1-925552-0
	20-17	0.5-1.0	.071-.130 1.80-3.30	.013 0.32	.429 10.90	Tin Plated Brass	1-925552-1
						Tin Plated Brass	1-925552-2 <sup>1</sup>
	20-15½	0.5-1.5	.071-.130 1.80-3.30	—	.630 16.00	Brass	926866-1
						Pre-Tin Plated Brass	926866-2
						Brass	926866-3 <sup>1</sup>
						Pre-Tin Plated Brass	926866-4 <sup>1</sup>

<sup>1</sup> Splice Free.

**Miscellaneous Terminals** (Continued)

**Wire Pins** (Continued)

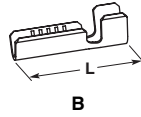

Type	Wire Range		Insul. Dia.	Stock Thickness	Dim. L	Material and Finish	Part Number
	AWG	mm <sup>2</sup>					
B	20-15½	0.5-1.5	.098-.150 2.50-3.80	.013 0.32	.311 7.90	Brass	141093-1
						Tin Plated Brass	141093-2
	20-15½	0.5-1.5	.091-.126 2.30-3.20	.016 0.40	.216 5.50	Brass	160644-1
						Silver Plated Brass	160644-2
						Tin Plated Brass	160644-3
						Silver Plated Brass	160644-4 <sup>1</sup>
	20-15½	0.5-1.5	.091-.126 2.30-3.20	.016 0.40	.216 5.50	Nickel Plated Steel	160644-6 <sup>1</sup>
						Tin Plated Brass	160644-7 <sup>1</sup>
	20-15½	0.5-1.5	.091-.126 2.30-3.20	.016 0.40	.216 5.50	Brass	160644-8
						Nickel Plated Brass	160644-9
						Tin Plated Brass	1-160644-0 <sup>1</sup>
						Brass	925553-1
B	17-13½	1.0-2.5	.098-.150 2.50-3.80	.013 0.32	.429 10.90	Pre-Tin Plated Brass	925553-2
						Phos. Bronze	925553-3
	17-13½	1.0-2.5	.098-.150 2.50-3.80	.013 0.32	.429 10.90	Pre-Tin Plated Phos. Bronze	925553-4
						Nickel Plated Steel	925553-6
	17-13½	1.0-2.5	.098-.150 2.50-3.80	.013 0.32	.429 10.90	Brass	925553-7 <sup>1</sup>
						Pre-Tin Plated Brass	925553-8 <sup>1</sup>
	17-13½	1.0-2.5	.098-.150 2.50-3.80	.013 0.32	.429 10.90	Phos. Bronze	925553-9 <sup>1</sup>
						Pre-Tin Plated Phos. Bronze	1-925553-0 <sup>1</sup>
17-13½	1.0-2.5	.098-.150 2.50-3.80	.013 0.32	.429 10.90	Nickel Plated Steel	1-925553-2 <sup>1</sup>	
					Brass	926867-1	
13½-10	2.5-6.0	.177 4.50 Max.	.013 0.32	.630 16.00	Pre-Tin Plated Brass	926867-2	
					Brass	926867-3 <sup>1</sup>	
					Pre-Tin Plated Brass	926867-4 <sup>1</sup>	
					Pre-Tin Plated Brass	926933-1	
18½-17	0.75-1.0	—	.010 0.25	.236 6.00	Brass	926933-2	
					Pre-Tin Plated Brass	926933-3	
					Brass	926933-4	
					Pre-Tin Plated Phos. Bronze	926933-5	
18½-17	0.75-1.0	—	.010 0.25	.236 6.00	Phos. Bronze	926933-6	
					Pre-Tin Plated Phos. Bronze	926933-7	
					Phos. Bronze	926933-8	
18½-17	0.75-1.0	—	.010 0.25	.236 6.00	Copper Nickel	926933-9	
15½-13½	1.5-2.5	—	.010 0.25	.276 7.00	Pre-Tin Plated Brass	925856-1	
					Brass	925856-2	
15½-13½	1.5-2.5	—	.010 0.25	.276 7.00	Phos. Bronze	925856-3	
					Pre-Tin Plated Phos. Bronze	925856-4	

<sup>1</sup> Splice Free.

**Miscellaneous Terminals** (Continued)

**AMPLIVAR Wire Pins with  
Insulation Support**

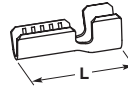

A

Type	Wire Range		Insul. Dia.	Stock Thickness	Dim. L	Material	Part Number
	CMA	mm <sup>2</sup>					
A	27-19	0.10-0.60	.055-.087 1.40-2.20	.016 0.40	.272 6.90	Brass	141075-1
						Tin Plated Brass	141075-2
	27-19	0.10-0.60	.098-.150 2.50-3.80	.016 0.40	.311 7.90	Brass	141175-11
						Tin Plated Brass	141175-2 <sup>1</sup>
	18-13	0.70-2.50	.098-.150 2.50-3.80	.016 0.40	.319 8.10	Brass	1-141175-1 <sup>2</sup>
						Tin Plated Brass	737060-1
					Pre-Tin Plated Brass	737060-2	
						737060-3	

<sup>1</sup> Reeled "U-up".

<sup>2</sup> Reeled "U-down".

**Application Tooling**

**AMP-O-LECTRIC Model G  
Terminating Machines,  
354500-1, -9, -11**



A totally new design of our most popular machine for bench-top operation. It features a quiet and highly-reliable direct motor drive, electronic controls for ease of setup and operation, and improved guarding and lighting for operator convenience and safety. All versions also include either manual or automatic precision adjustment for crimp height. For use with miniature style applicators only.  
(Shown with optional Crimp Quality Monitor [CQM].)

**Specifications**

**Weight** — Approximately 240 lb [110 kg]  
**Width** — 18.7-25.3 [475-643] depending on type of applicator used  
**Depth** — 21.5-28.1 [546-713] depending on type of applicator used  
**Height** — 20 [508] without reel  
**Electrical** — 120 or 220 VAC, 50 or 60 Hz  
**Air** — 90-110 psi [6.21-7.59 bar] when required for use with air-feed applicators  
**Wire Range** — 26-10 AWG [0.12-6.0 mm<sup>2</sup>] solid or stranded, depending on product applied

For more information, request Catalog **65828**.

**AMP 3K/40 and AMP 5K/40  
Terminating Machines**



The AMP 3K/40 and AMP 5K/40 Terminators are designed for customers that require the increased output and quality of a semiautomatic machine at a competitive price. By incorporating the most commonly requested features as standard and offering a long list of optional equipment, these terminators offer flexibility to meet the specific needs of various applications at the lowest possible cost.

- 3,000 lb [1361 kg] max. crimp force (AMP 3K/40)
- 5,000 lb [2268 kg] max. crimp force (AMP 5K/40)

- Tool-less removal of applicators and guards
- Jog capability
- Quiet, fast operation — 80/76 dBA and cycle time less than 0.400 seconds
- Accepts Heavy Duty Mini style applicators
- Wide range of optional equipment such as tool-less precision crimp height adjust, batch counter, CQM capability and work light
- Order Catalog 1654856 for specs and part numbers

**Specifications**

**Height** — 20 [510] (without reel support)  
**Weight** — Approx. 150 lb [68 kg]  
**Capacity** — AMP 3K/40 — 3,000 lb [1361 kg] max. crimp force; AMP 5K/40 — 5,000 lb [2268 kg] max. crimp force  
**Noise** — 76 dBA maximum at 3,000 lb [1361 kg] full capacity; 80 dBA maximum at 5,000 lb [2268 kg] full capacity  
**Electrical** — 100-240 VAC, 50/60 Hz (6A) • Average <1 A at 120 VAC when used as a bench-top unit at 2 000 cycles per hour operating rate  
**Air** — 90-100 psi [6.21-6.90 bar], 6 scfm [0.00282 m<sup>3</sup>/s] (when required for use with air-feed applicators)  
*Note: Optional Air Feed Valve Assembly required.*

**Application Tooling** (Continued)

**Optional Stripping Module for the AMP 3K/40, AMP 5K/40 and AMP-O-LECTRIC Model G Terminating Machines**

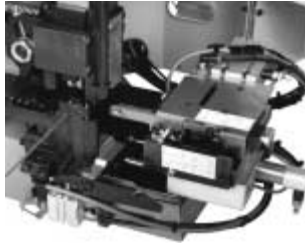

The combination of the Stripping Module with the AMP 3K/40, AMP 5K/40 or the AMP-O-LECTRIC Model G terminating machines provides our customers with an economic and proficient method of stripping the wire and crimping terminals on the same machine. No longer is a special machine needed for just stripping the wire. The wires are stripped moments before crimping, which means that there is virtually no chance of dam-

aging the wire conductors during handling or storage. Wire placement accuracy is also improved because once the wire is fed into the start sensor, the Stripping Module does the rest.

**Specifications**

**Wire Range Base Module** — 32-14 AWG [0.03 mm<sup>2</sup> - 2.5 mm<sup>2</sup>] (30-32 AWG may require special kit.)  
**Max. Insulation** — .200 [5.08]  
**Cable Breakout** — > 1.1 [29]  
**Strip Length** — .100 - .400 [2.5 - 10.16]

**Noise** — Less than 82 dBA (Typical at operator position with standard mechanical feed applicator)  
**Weight** — 10 lb [4.53 Kilograms]  
**Height** — 5 [127]  
**Electrical** — 100-240 VAC, 50/60 Hz, single phase current, obtains power from the terminator  
**Air** — 90-100 psi [620-760 kPa], 6 scfm [2.83 liters/sec]  
**Wire Sensor** — Gold plated contacts with laser etched target

For more information, request Catalog **1309085**.

**Crimp Quality Monitor (CQM)**



This unique system provides 100% on-the-fly crimp inspection. It measures the crimp height of each termination, and evaluates the quality of each crimp. If a crimp is questionable, the monitor alerts the operator with both visual and audible alarms. It also provides ports for printing and networking.

When used with AMP-O-LECTRIC Model "G" Termination Machines, the monitor is mounted to the machine. When used with AMPOMATOR CLS IV Lead Making Machines, it is integrated into the machine's operating system, with the information displayed on the machine's touch screen.

**Specifications**

**Width** — 8.5 [216]  
**Depth** — 9 [229]  
**Height** — 4.5 [114]  
**Electrical** — 120 VAC, 50 or 60 Hz, or 220 VAC, 50 or 60 Hz  
**Printer Port** — Serial Interface

For more information, request Catalog **82275**.

**5-Ton Machine, Part Number 565433-4**



This machine is used with special standard style applicators to apply splices and terminals requiring crimping forces greater than the maximum output of AMP-O-LECTRIC Termination Machines.

The machine is a modification of a Fixed Bed Gap mechanical clutch press manufactured by Benchmaster Products, Inc.

**Specifications**

**Width** — 29 [737]  
**Depth** — 25.4 [645]  
**Height** — 35.5 [902] without reel  
**Weight** — Approximately 250 lb [113 kg]  
**Electrical** — 120 VAC, 60 Hz, 6 A  
**Air** — 90-100 psi [6.21-7.59 bar] when required for use with air-feed applicators

**Carbon Brush Machine, Part Number 459248-2**



This machine is a modified AMP-O-LECTRIC Model "K" Termination Machine equipped with a mechanism that compresses the spring and pulls the shunt wire through the spring over the terminal.

The machine can terminate shunt wires ranging from .812-4.78 [20.6-121] in length depending on the type of terminal used. It can accept springs with an inside diameter of .130-.427 [3.30-10.8]

**Specifications**

**Width** — 27 [68.6]  
**Depth** — 27 [68.6]  
**Height** — 28 [71.1] without reel  
**Weight** — Approximately 250 lb [113 kg]  
**Electrical** — 120 VAC, 60 Hz, 6 A  
**Air** — 80-100 psi [5.51-6.89 bar]

**Application Tooling** (Continued)

**AMPOMATOR CLS IV+  
Lead-Making Machines, 356500-1, -2**



Fully-automatic machines that measure, cut, strip and terminate single leads. Microprocessor-controlled, and programmed and operated using an easy-to-follow, menu-driven touch-screen. Features include direct-drive terminating units with precision crimp height adjustment, fully programmable setups, wire runout and splice detection, and motorized pre-feed with wire straightener. Crimp Quality Monitoring is also available.

**Specifications**

- Width** — 159 [4 040]
- Depth** — 68 [1 730]
- Height** — 86 [2 185] with 24 [610] dia. reel
- Weight** — 2 000 lb [907 kg]
- Electrical** — 220 VAC, 50 or 60 Hz, single phase, 25 A, with neutral and ground
- Air** — 90 psi [6.21 bar], 15 scfm [0.0071 m<sup>3</sup>/s] sustained
- Wire Range** — 26-10 AWG [0.12-6 mm<sup>2</sup>] stranded, 26-16 AWG [0.12-1.4 mm<sup>2</sup>] solid
- Lead Lengths** — 3-90 [76.2-2 285], 90-1 000 [2 285-25 400] with long lead conveyors

For more information, request Catalog **124324**.

**Applicators**



**End- and Side-Feed  
Heavy-Duty Miniature  
(HDM) Applicators**

Tyco Electronics applicators are designed to exacting specifications to produce consistent, high-quality terminations.

HDM applicators are quickly interchangeable and easily repaired. They feature simple dial-in settings for adjusting crimp height for terminating different wire combinations within the designated CMA range.

These applicators are used with both bench machines and fully-automatic lead makers. They can also be used for crimp quality monitoring on systems equipped with the CQM G-Adapter. Call the Tooling Assistance Hotline at 1-800-722-1111 for further information.



**Standard (STD) Applicators**

Standard style applicators are generally used for long production runs using dedicated equipment, or when splicing a coil, for example, that needs to be positioned close to the crimping area in the applicator. The crimp height can be adjusted by raising or lowering the base mount.



**Standard Style Applicator  
for Large CMA Splice,  
Part Number 566372-2**

This applicator was designed specifically to apply AMP 5 000-16 000 CMA Splice, Part Number 63625-1. It features a highly-visible, close-up crimp area—less than 1 [25] from the front of the guard. You can easily splice multiple wires by simply rotating them down through the front of the guard into the crimp area.

It is an air-feed applicator, and can be used with AMP-O-ELECTRIC Model K termination machine Part Number 1-471273-2 or 1-471273-3.

**Part Number Index**

**Note:** This index lists all cataloged parts by base no. only. Complete part nos. (with prefixes and/or suffixes) are shown on the page(s) indicated.

Part No.	Page
34578	16
34812	16
34839	16
34848	16
40509	28
40517	16
40521	24
40523	17
40524	17
40552	28
40577	24
40593	16
40594	16
40595	16
40604	14
40605	14
40626	64
40652	54
40660	11
40661	11
40662	63
40668	16
40696	17
40697	9
40698	9
40702	16
40705	24
40723	11
40724	11
40725	11
40749	16
40763	22
40764	25
40765	25
40766	25
40771	29
40777	16
40796	17
40797	18
40800	65
40808	22
40810	16
40811	16
40812	16
40816	16
40862	28
40868	28
40884	16
40888	10
40891	24
40894	10
40951	17
40952	28
40955	10
40960	14
40973	14
40976	16

Part No.	Page
40977	17
40979	16
40990	61
41006	16
41013	9
41090	17
41108	30
41124	15
41125	15
41126	15
41215	28
41276	30
41282	30
41294	14
41330	12
41332	12
41333	12
41341	17
41343	22
41346	16
41356	17
41376	19
41397	28
41406	10
41409	19
41443	20
41456	10
41459	28
41461	24
41471	10
41472	10
41473	24
41495	24
41499	16
41558	11
41559	12
41560	12
41579	9
41580	9
41581	9
41582	9
41589	22
41590	22
41604	14
41627	28
41698	56
41711	9
41765	47
41766	47
41770	47
41808	15
41809	15
41854	54
41870	54
41899	47
41900	47
41904	47
41911	17
41933	25
41974	28
41975	28
41989	58

Part No.	Page
41996	28
42023	19
42036	9
42037	9
42054	17
42065	11
42076	47
42101	55
42110	17
42111	17
42113	24
42119	47
42142	57
42160	22
42164	9
42168	23
42169	23
42185	16
42187	25
42188	25
42189	20
42190	20
42191	20
42192	47
42204	16
42218	63
42308	55
42318	24
42329	28
42339	25
42349	61
42412	65
42425	17
42428	53
42429	53
42508	9
42519	59
42531	57
42547	9
42555	17
42581	57
42627	29
42639	14
42673	18
42700	57
42716	17
42721	11
42722	15
42745	55
42749	57
42751	14
42752	14
42765	59
42776	47
42778	47
42779	47
42780	47
42827	54
42863	15
42864	15
42865	56
42868	57

Part No.	Page
42869	54
42890	17
42891	57
42899	15
42913	15
42920	61
42933	11
42938	14
42946	15
42947	15
60007	9
60017	57
60024	12
60115	52
60123	9
60124	22
60177	55
60187	23
60234	25
60250	17
60251	22
60252	58
60312	58
60319	21
60320	21
60321	21
60322	21
60323	21
60348	53
60372	27
60373	53
60376	55
60389	22
60390	22
60394	11
60422	19
60432	58
60433	12
60436	58
60440	54
60442	59
60445	22
60469	53
60470	28
60477	58
60485	14
60501	22
60505	17
60524	58
60546	11
60553	9
60555	9
60581	61
60625	12
60654	64
60660	56
60700	11
60725	22
60733	54
60744	12
60752	21
60766	56



**Part Number Index** (Continued)

Part No.	Page	Part No.	Page	Part No.	Page	Part No.	Page
60770	12	61588	10	62344	52	63575	63
60771	12	61616	58	62352	58	63594	54
60772	12	61622	53	62357	28	63602	13
60772	13	61624	14	62358	52	63610	23
60773	22	61652	9	62382	29	63612	21
60774	22	61653	9	62399	58	63615	58
60775	22	61674	52	62402	54	63621	48
60793	56	61710	21	62405	54	63628	12
60798	57	61764	10	62416	56	63640	13
60799	57	61769	27	62419	29	63649	21
60806	29	61777	13	62503	29	63676	16
60812	62	61793	13	62505	52	63678	12
60884	54	61794	13	62516	29	63698	14
60885	53	61795	13	62587	64	63701	61
60891	59	61802	56	62589	58	63707	14
60900	58	61813	58	62612	15	63721	9
60908	54	61831	65	62613	15	63723	64
60932	28	61844	15	62616	52	63733	63
60933	28	61853	19	62638	9	63750	12
60997	28	61855	23	62670	48	63797	9
60998	23	61857	23	62686	16	63834	28
61008	28	61863	13	62691	15	63863	64
61012	55	61866	15	62700	13	63865	57
61013	52	61867	13	62720	54	63872	11
61021	29	61868	15	62727	64	63895	63
61039	63	61891	56	62739	56	63925	56
61074	47	61904	10	62754	27	63930	62
61142	17	61933	62	62755	21	63989	56
61165	63	61941	58	62759	27	63997	13
61166	48	61987	65	62786	13	109451	14
61238	22	62000	46	62787	13	109452	12
61263	61	62001	46	62795	23	109453	9
61280	63	62002	46	62820	52	109454	9
61283	10	62008	62	62827	61	141075	68
61289	15	62009	62	62829	56	141093	67
61299	27	62040	46	62835	21	155352	28
61300	29	62041	58	62975	13	155353	28
61312	9	62044	48	63020	62	155386	61
61336	14	62062	61	63035	64	156523	64
61352	15	62074	52	63053	25	160102	10
61359	13	62134	61	63130	27	160108	10
61385	25	62153	61	63147	21	160644	67
61386	10	62157	46	63182	62	350010	62
61388	56	62160	54	63183	62	350053	52
61390	62	62185	53	63243	16	350080	14
61397	13	62194	48	63268	23	350199	14
61412	57	62200	46	63374	22	350436	13
61424	15	62201	46	63381	54	350502	22
61436	10	62214	62	63391	58	350509	10
61443	20	62281	64	63399	21	350568	23
61454	58	62295	46	63431	48	350571	21
61463	16	62303	46	63432	28	350981	14
61489	58	62304	46	63446	21	485003	9
61492	28	62305	46	63457	16	485015	18
61498	25	62306	46	63482	13	485016	27
61505	19	62307	46	63506	55	485020	28
61519	25	62308	46	63514	11	485029	13
61520	65	62309	46	63518	14	485030	13
61524	62	62310	46	63526	24	485043	27
61546	18	62311	46	63561	47	485044	21
61547	53	62318	28	63562	47	485064	29
61556	10	62341	48	63564	47	485073	23

**Part Number Index** (Continued)

Part No.	Page	Part No.	Page	Part No.	Page	Part No.	Page
485079	21	1601511	37	1601618	37	1601719	41
505020	64	1601513	37	1601619	37	1601721	37
505033	29	1601514	35	1601620	35	1601722	37
505034	63	1601520	34	1601623	35	1601723	37
505038	56	1601528	36	1601625	35	1601726	36
626034	12	1601529	36	1601628	35	1601729	36
640007	14	1601531	36	1601629	35	1601730	36
640008	11	1601532	36	1601630	35	1601731	36
640009	15	1601538	42	1601631	35	1601733	36
640011	14	1601539	42	1601632	33	1601750	41
640012	15	1601540	42	1601633	33	1601754	36
640051	13	1601542	38	1601635	38	1601755	36
640052	13	1601545	38	1601637	42	1601761	41
640082	11	1601546	38	1601639	41	1601764	36
640102	14	1601547	38	1601640	37	1601765	36
640189	19	1601548	37	1601642	36	1601766	36
640204	10	1601549	37	1601644	42	1601768	34
640212	21	1601550	34	1601646	42	1601769	33
640216	15	1601551	34	1601647	42	1601771	33
640249	15	1601553	34	1601649	38	1601793	42
640253	14	1601555	38	1601650	37	1601794	41
640257	18	1601559	42	1601651	37	1601795	38
640260	25	1601560	42	1601652	37	1601797	34
640271	10	1601562	38	1601654	37	1601798	34
737060	68	1601564	38	1601655	35	1601800	42
925552	66	1601566	37	1601656	35	1601807	34
925553	67	1601569	37	1601658	35	1601808	37
925667	66	1601571	37	1601660	35	1601809	37
925856	67	1601572	34	1601661	35	1601810	37
926823	66	1601573	34	1601664	35	1601811	35
926824	66	1601575	33	1601665	35	1601814	41
926866	66	1601577	33	1601667	35	1601818	35
926867	67	1601578	33	1601668	35	1601819	35
926933	67	1601580	38	1601669	34	1601820	35
964156	46	1601582	38	1601675	42	1601823	41
1217012	63	1601583	38	1601677	41	1601824	41
1217070	57	1601584	38	1601678	41	1601825	38
1217074	57	1601586	37	1601680	36	1601827	37
1217104	56	1601587	35	1601681	36	1601828	35
1217142	56	1601588	35	1601682	36	1601829	35
1217160	12	1601591	35	1601683	42	1601832	42
1217185	56	1601593	33	1601687	37	1601833	41
1217330	14	1601596	38	1601689	36	1601835	41
1217384	47	1601597	37	1601691	36	1601837	37
1217440	65	1601599	37	1601693	36	1601841	36
1217507	62	1601600	37	1601694	36	1601842	41
1217510	61	1601601	35	1601695	36	1601844	42
1217569	65	1601603	35	1601705	41	1601845	42
1217698	62	1601604	42	1601706	41	1601846	41
1217881	64	1601606	42	1601707	41	1601847	41
1217967	27	1601607	41	1601709	36	1601848	41
1375622	29	1601608	41	1601710	36	1601852	36
1438246	29	1601610	38	1601711	36	1601853	33
1438254	30	1601611	38	1601712	36	1601857	41
1601503	38	1601612	38	1601716	42		
1601504	38	1601614	37	1601717	41		
1601507	35	1601617	37	1601718	41		

**Americas**

**Argentina** – Buenos Aires  
 Phone: +54-11-4733-2200  
 Fax: +54-11-4733-2250

**Brazil** – São Paulo  
 Phone: +55-11-3611-1311  
 Fax: +55-11-3611-0397

**Canada** – Markham  
 Phone: +905-475-6222  
 Fax: +905-474-5520  
**Product Information Center:  
 (Technical Support)**  
 Phone: +905-470-4425  
 Fax: +905-474-5525

**Colombia** – Bogota  
 Phone: +57-1-240-9396  
 Fax: +57-1-660-0206

**Mexico** – Mexico City  
 Phone: +52-55-5-729-0425  
 Fax: +52-55-5-398-1430

**United States** – Harrisburg, PA  
 Phone: +717-564-0100  
 Fax: +717-986-7575

**Product Information Center:  
 (Technical Support)**  
 Phone: +800-522-6752  
 Fax: +717-986-7575

**For Latin/South American  
 Countries not shown**  
 Phone: +57-1-240-9396  
 Fax: +57-1-660-0206

**Asia/Pacific**

**Australia** – Sydney  
 Phone: +61-2-9840-8200  
 Fax: +61-2-9899-5649

**Product Information Center:  
 (Technical Support)**  
 Phone: +61-2-9554-2600  
 Fax: +61-2-9502-2556

**India** – Bangalore  
 Phone: +91-80-841-0200  
 Fax: +91-80-841-0210

**Indonesia** – Jakarta  
 Phone: +6221-526-7852  
 Fax: +6221-526-7856

**Japan** – Kawasaki, Kanagawa  
 Phone: +81-44-844-8079  
 Fax: +81-44-844-8733

**Product Information Center:  
 (Technical Support)**  
 Phone: +81-44-844-8013  
 Fax: +81-44-812-3200

**Raychem Products**  
 Phone: +81-44-900-5102  
 Fax: +81-44-5025-5027

**Korea** – Seoul  
 Phone: +82-2-3274-0535  
 Fax: +82-2-3274-0524/0531

**Malaysia** – Selangor  
 Phone: +60-3-7053055  
 Fax: +60-3-7053066

**New Zealand** – Auckland  
 Phone: +64-9-634-4580  
 Fax: +64-9-634-4586

**Philippines** – Makati City  
 Phone: +632-867-8641  
 Fax: +632-867-8661

**People's Republic of China**  
 Hong Kong  
 Phone: +852-2735-1628  
 Fax: +852-2735-0243

Shanghai  
 Phone: +86-21-6485-0602  
 Fax: +86-21-6485-0728

Shunde  
 Phone: +86-765-775-1368  
 Fax: +86-765-775-2823

**Singapore** – Singapore  
 Phone: +65-4820-311  
 Fax: +65-4821-012

**Raychem Products**  
 Phone: +65-4866-151  
 Fax: +65-6545-514

**Taiwan** – Taipei  
 Phone: +886-2-2664-9977  
 Fax: +886-2-2664-9900

**Thailand** – Bangkok  
 Phone: +66-2-955-0500  
 Fax: +66-2-955-0505

**Vietnam** – Ho Chi Minh City  
 Phone: +84-8-8232-5467  
 Fax: +84-8-8221-443

**Europe/Middle East/Africa**

**Austria** – Vienna  
 Phone: +43-190-560-0  
 Fax: +43-190-560-1333

**Belgium** – Kessel-Lo  
 Phone: +32-16-352-300  
 Fax: +32-16-352-352

**Bulgaria** – Sofia  
 Phone: +359-2-971-2152  
 Fax: +359-2-971-2153

**Czech Republic** – Kurim  
 Phone: +420-5-41-162-111  
 Fax: +420-5-41-162-223

**Denmark** – Viby J  
 Phone: +45-70-15-52-00  
 Fax: +45-86-29-51-33

**Egypt** – Cairo  
 Phone: +20-2-417-76-47  
 Fax: +20-2-419-23-34

**Estonia** – Tallinn  
 Phone: +372-65-05-474  
 Fax: +372-65-05-470

**Finland** – Helsinki  
 Phone: +358-95-12-34-20  
 Fax: +358-95-12-34-250

**France** –  
 Cergy-Pontoise  
 Phone: +33-1-3420-8888  
 Fax: +33-1-3420-8600  
**Product Information Center:  
 (Technical Support)**  
 Phone: +33-1-3420-8943  
 Fax: +33-1-3420-8623

**France**  
**Tyco Electronics Export** –  
 St Ouen L'Aumone  
 Phone: +33-1-3440-7200  
 Fax: +33-1-3440-7220 or  
 +33-1-3440-7230

**Germany** – Bensheim  
 Phone: +49-6251-133-0  
 Fax: +49-6251-133-1600  
**Product Information Center:  
 (Technical Support)**  
 Phone: +49-6251-133-1999  
 Fax: +49-6251-133-1988

**Germany** – Langen  
 Phone: +49-6103-709-0  
 Fax: +49-6103-709-1223

**Germany** – Speyer  
 Phone: +49-6232-30-0  
 Fax: +49-6232-30-2243

**Germany**  
**HTS Division** – Neunkirchen  
 Phone: +49-2247-305-0  
 Fax: +49-2247-305-122

**Great Britain** –  
 Stanmore Middlesex  
 Phone: +44-181-954-2356  
 Fax: +44-181-954-6234  
**Product Information Center:  
 (Technical Support)**  
 Freephone GB: 0800-267-666  
 Phone: +44-141 810 8967...69  
 Fax: +44-141 810 8971  
**Great Britain** – Dorcan, Swindon  
**Raychem Products**  
 Phone: +44-1793-528171  
 Fax: +44-1793-572516

**Greece** – Athens  
 Phone: +30-1-9370-396/397  
 Fax: +30-1-9370-655

**Hungary** – Budapest  
 Phone: +36-1-289-1000  
 Fax: +36-1-289-1010

**Ireland** – Dublin  
 Phone: +353-1-820-3000  
 Fax: +353-1-820-9790

**Israel** – Yokneam  
 Phone: +972-4-959-0508  
 Fax: +972-4-959-0506

**Italy** – Collegno (Torino)  
 Phone: +39-011-4012-111  
 Fax: +39-011-4031-116

**Lithuania** – Vilnius  
 Phone: +370-5-21-31-402  
 Fax: +370-5-21-31-403

**Netherlands** – 's-Hertogenbosch  
 Phone: +31-73-6246-246  
 Fax: +31-73-6212-365  
**Product Information Center:  
 (Technical Support)**  
 Phone: +31-73-6246-999  
 Fax: +31-73-6246-998

**Norway** – Nesbru  
 Phone: +47-66-77-88-99  
 Fax: +47-66-77-88-55

**Poland** – Warsaw  
 Phone: +48-22-45-76-700  
 Fax: +48-22-45-76-720

**Romania** – Bucharest  
 Phone: +40-1-311-3479+3596  
 Fax: +40-1-312-0574

**Russia** – Moscow  
 Phone: +7-095-926-55-06...09  
 Fax: +7-095-926-55-05

**Russia** – St. Petersburg  
 Phone: +7-812-325-30-83  
 Fax: +7-812-325-32-88

**Scotland** – Dundee  
**Madison Cable Products**  
 Phone: +44-1382-508080  
 Fax: +44-1382-505060

**Slovakia** – Banská Bystrica  
 Phone: +421-48-415-20-11/12  
 Fax: +421-48-415-20-13

**Slovenia** – Ljubljana  
 Phone: +386-1561-3270  
 Fax: +386-1561-3240

**South Africa** – Port Elizabeth  
 Phone: +27-41-405-4500  
 Fax: +27-41-486-1314

**Spain** – Barcelona  
 Phone: +34-93-291-0330  
 Fax: +34-93-201-7879  
**Product Information Center:  
 (Technical Support):**  
 Phone: +34-93-291-0330  
 Fax: +34-93-200-3779

**Sweden** – Upplands Väsby  
 Phone: +46-8-50-72-50-00  
 Fax: +46-8-50-72-50-01

**Switzerland** – Steinach  
 Phone: +41-71-447-0447  
 Fax: +41-71-447-0444

**Turkey** – Istanbul  
 Phone: +90-212-281-8181...3  
 +90-212-282-5130/5430  
 Fax: +90-212-281-8184

**Ukraine** – Kiev  
 Phone: +38-044-238-6908  
 Fax: +38-044-568-5740

**tyco**

*Electronics*

TYCO ELECTRONICS CORPORATION

**AMP**

