

PIDG FASTON Receptacles and Tabs

Product Facts

- Pre-insulated terminal designed for complete and uniformed reliability in the most difficult circuit environment
- Consists of an unplated or tin plated brass body or a tin plated phosphor bronze body with a specially designed copper sleeve and insulation sleeve fitted over the terminal barrel
- Design of the tool dies and construction of the terminal insures uniform insulation thickness under crimping pressure, transmitting this pressure evenly to the center of the crimp area

The Tyco Electronics Mated Tool/Terminal Concept

- Tyco Electronics compression crimping produces crimps for a given size wire and terminal that are precisely alike in appearance and performance
- Terminal and the crimping tool are designed as precisely matched devices
- Dies are precision-engineered from the finest hard-metal alloys
- Crimping pressure is controlled by a ratchet device on the hand tool or a corresponding pre-calibration in the crimping jaws of Tyco Electronics automated crimping machines

The Crimp

- Crimping pressure does not overstress nor understress the terminal barrel — machined dies fully bottom to the precise crimp height
- Resulting termination is free of contamination
- Resistant to most shock and critical environments
- Tensile strength approaches that of the wire itself

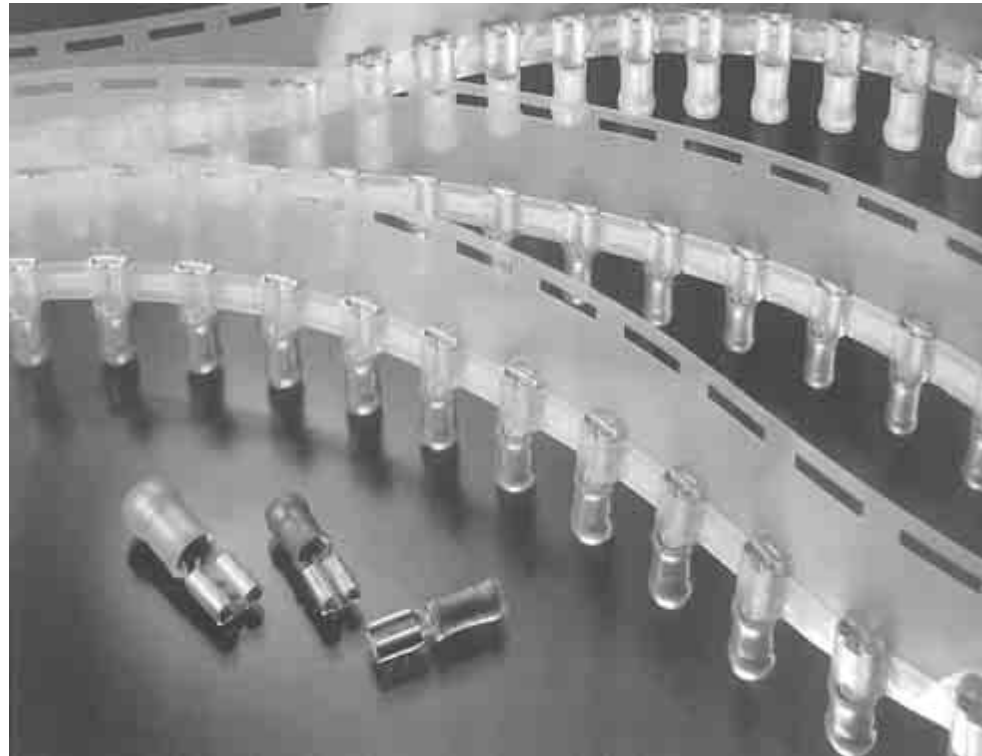

Here is a pre-insulated terminal designed for complete and uniform reliability in most difficult circuit environments. Each PIDG Terminal consists of a tin plated brass body with a specially designed copper sleeve and insulation sleeve fitted over the terminal barrel. The design of the tool dies and the construction of the terminal promotes uniform insulation thickness under crimping pressure, transmitting this pressure evenly to the center of the crimp area.

Tyco Electronics compression crimping produces crimps for a given size wire and terminal that are precisely alike in appearance and performance. This is a calculated result made possible by designing the terminal and the crimping tool as precisely matched devices. The dies are precision-engineered from the finest hard-metal alloys. Crimping pressure is controlled by a ratchet device on the hand tool or a corresponding pre-

calibration in the crimping jaws of Tyco Electronics automated crimping machines.

Crimping pressure can neither over-stress nor understress the terminal barrel — machined dies fully bottom to the precise crimp height required.

The resulting termination is free of contamination, is resistant to shock and critical environments, and its tensile strength approaches that of the wire itself.

Temperature Rating: 105° C

Wire Range	E66717 Recognized	LR7189 Certified
22-16	22-16 Stranded	300 V Max., 105°C Max. ¹
16-14	16-14 Stranded	
12-10	12-10 Stranded	

¹ UL and CSA — Nylon.

PIDG FASTON Receptacles and Tabs (Continued)

Receptacles

Receptacle Style

- A** — No dimple with wire stop
- B** — Dimple with wire stop
- C** — No dimple, no wire stop

Material

- Insulation** — Nylon
- Receptacle Body** — Brass per ASTM B-36 or Phosphor Bronze per ASTM B-139
- Plating** — Tin per MIL-T-10727 except where noted.
- Metallic Sleeve** — Copper per ASTM B-152
- Plating** — Tin per MIL-T-10727

Related Product Data

Application Tooling — reference page 73 of Catalog 82042 for tooling

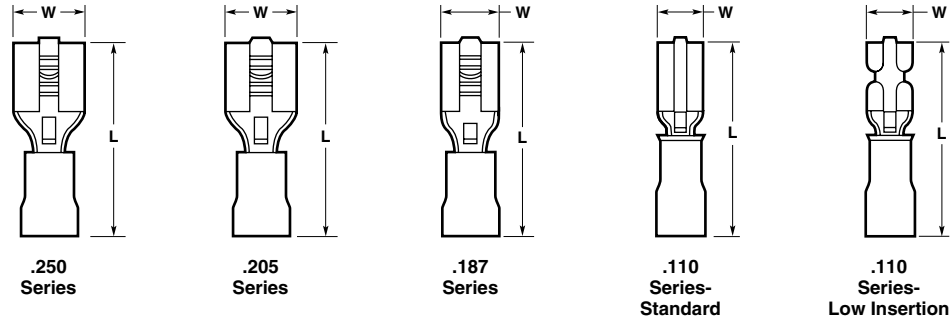

Series	Wire Size Circular Mils [mm ²]	Style	Dimensions		Terminal Insulation Color	Wire Insulation Diameter Max.	Recept. Matl.	Stock Thk.	Fits Tab Thk.	Part Numbers			
			W Nom.	L Max.						Loose Piece	Tape Mounted	Strip Form	
.250	22-18 509-1,900 [0.26-0.96]	B	.300 7.62	.900 22.86	Red	.140 3.56	Brass	.018 0.46	.032 0.81	640903-1*	640903-2	640902-1	
					Red	.140 3.56	Brass	.018 0.46	.032 0.81	55675-1 ²	55675-2 ²	—	
	16-14 2,050-5,180 [1.04-2.62]	B	.300 7.62	.900 22.86	Blue	.170 4.32	Brass	.018 0.46	.032 0.81	640905-1*	640905-2	640904-1	
					Blue	.250 6.35	Brass	.018 0.46	.032 0.81	696108-1	696108-2	696109-1	
	14-12 3,831-6,470 ¹ [1.94-3.28]	B	.300 7.62	1.012 25.70	Green	.250 6.35	Brass	.018 0.46	.032 0.81	42844-1 ^{††}	42844-3 [†]	60544-3 [†]	
					Green	.250 6.35	Phos. Brz.	.018 0.46	.032 0.81	42844-2 ^{††}	—	—	
	12-10 5,180-13,100 [2.62-6.64]	B	.300 7.62	1.012 25.70	Yellow	.250 6.35	Brass	.018 0.46	.032 0.81	640907-1*	640907-2	640906-1	
					Yellow	.250 6.35	Phos. Brz.	.018 0.46	.032 0.81	61198-2 ^{3†}	61198-4 ^{4†}	—	
	.250 Low Insertion	22-18 509-1,900 [0.26-0.96]	B	.300 7.62	.900 22.86	Red	.145 3.68	Brass	.016 0.41	.032 0.81	184262-1	184262-2	184261-1
						Blue	.173 4.39	Brass	.016 0.41	.032 0.81	184265-1	184265-2	184264-1
.205	22-18 509-1,900 [0.26-0.96]	B	.250 6.35	.800 20.32	Red	.135 3.43	Brass	.016 0.41	.020 0.51	696018-1	696018-2	—	
					Red	.140 3.56	Brass	.016 0.41	.020 0.51	640909-1*	640909-2	640908-1	
					Red/Black	.140 3.56	Brass	.016 0.41	.020 0.51	640174-1	—	—	
	16-14 2,050-5,180 [1.04-2.62]	B	.250 6.35	.800 20.32	Red	.140 3.56	Brass	.016 0.41	.032 0.81	640911-1*	640911-2	640910-1	
					Blue	.170 4.32	Brass	.016 0.41	.020 0.51	640913-1*	640913-2	—	
					Blue	.170 4.32	Brass	.016 0.41	.032 0.81	640915-1*	640915-2	—	
.187	26-24 238-475 [0.12-0.24]	B	.230 5.84	.700 17.78	Yellow	.082 2.08	Brass	.016 0.41	.020 0.51	641321-1 ^{††}	641321-2 [†]	641320-1 [†]	
					Red	.140 3.56	Brass	.016 0.41	.020 0.51	640917-1*	640917-2	640916-1	
	22-18 509-1,900 [0.26-0.96]	B	.230 5.84	.800 20.32	Red	.140 3.56	Brass	.016 0.41	.040 1.02	—	640578-2 [†]	—	

[†] Not UL or CSA approved or listed.

* Available in small packaging quantities.

¹ Wire range is limited as noted.

² Unplated receptacle body.

³ Requires Tool 90276-2

⁴ Requires Die 90281-1

Note: All part numbers are RoHS compliant.

PIDG FASTON Receptacles and Tabs (Continued)

Receptacles (Continued)

Series	Wire Size Circular Mils [mm ²]	Style	Dimensions		Terminal Insulation Color	Wire Insulation Diameter Max.	Recept. Matl.	Stock Thk.	Fits Tab Thk.	Part Numbers						
			W Nom.	L Max.						Loose Piece	Tape Mounted	Strip Form				
.187	16-14 2,050-5,180 [1.04-2.62]	B	.230 5.84	.800 20.32	Blue	.170 4.32	Brass	.016 0.41	.020 0.51	640919-1*	640919-2	640918-1				
			.230 5.84	.900 22.86	Blue	.250 6.35	Brass	.016 0.41	.032 0.81	696108-1†	696108-2†	—				
.187 Low Insertion	16-14 509-1,900 [0.26-0.96]	B	.235 5.84	.800 20.32	Blue	.170 4.32	Brass	.016 0.41	.032 0.81	184235-1	184235-2	184234-1				
			.230 5.84	.800 22.86	Red	.145 3.68	Brass	.016 0.41	.032 0.81	184268-1†	184268-2†	184267-1†				
.110 Standard	22-18 509-1,900 [0.26-0.96]	B	.148 3.76	.734 18.64	Natural	.110 2.79	Brass	.012 0.30	.016 0.41	61048-1*†	61048-2†	—				
			.148 3.76	.734 18.64	Natural	.110 2.79	Brass	.012 0.30	.020 0.51	61060-1*†	61060-2†	61059-2†				
			.148 3.76	.734 18.64	Natural	.110 2.79	Brass	.012 0.30	.032 0.81	60894-1*†	60894-2†	60893-2†				
			.148 3.76	.734 18.64	Black	.110 2.79	Brass	.012 0.30	.032 0.81	—	61678-2†	—				
	26-24 238-475 [0.12-0.24]	A	.160 4.06	.700 17.78	Yellow	.082 2.08	Brass	.016 0.41	.020 0.51	641324-1†	641324-2†	—				
			.160 4.06	.796 20.22	Red	.140 3.56	Brass	.016 0.41	.012 0.30	—	—	350871-1†				
.110 Low Insertion	22-18 509-1,900 [0.26-0.96]	A	.160 4.06	.800 20.32	Red	.140 3.56	Brass	.016 0.41	.016 0.41	.016 0.41	.020 0.51	.032 0.81	640921-1	640921-2	—	
			.160 4.06	.800 20.32	Red	.140 3.56	Brass	.016 0.41	.016 0.41	.020 0.51	.032 0.81	.032 0.81	.020 0.51	640923-1*	640923-2	640922-1
	16-14 2,050-5,180 [1.04-2.62]	A	.160 4.06	.800 20.32	Blue	.170 4.32	Brass	.016 0.41	.016 0.41	.020 0.51	.032 0.81	.032 0.81	640929-1*	640929-2	—	
			.160 4.06	.800 20.32	Blue	.170 4.32	Brass	.016 0.41	.016 0.41	.016 0.41	.016 0.41	.016 0.41	.016 0.41	640931-1*	640931-2	—
			.160 4.06	.796 20.19	Blue	.170 4.32	Brass	.016 0.41	.016 0.41	.032 0.81	641317-1	—	—	—	—	

†Not UL or CSA approved or listed.

*Available in small packaging quantities.

Receptacles (Insulation Restricting)

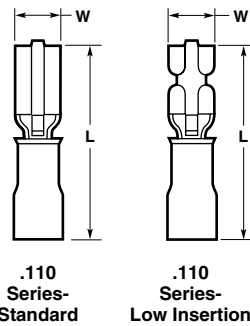

Material

- Insulation** — Nylon
- Receptacle Body** — Brass per ASTM B-36
- Receptacle Style B** — Dimple with wire stop
- Plating** — Tin per MIL-T-10727
- Metallic Sleeve** — Copper per ASTM B-152
- Plating** — Tin per MIL-T-10727 or Nickel per QQ-N-290

Related Product Data

Application Tooling — reference page 73 of Catalog 82042 for tooling

Series	Wire Size Circular Mils [mm ²]	Style	Dimensions		Terminal Insulation Color Solid/Stripe	Wire Insulation Diameter Max.	Recept. Matl.	Stock Thk.	Fits Tab Thk.	Part Numbers		
			W Nom.	L Max.						Loose Piece	Tape Mounted	Strip Form
.110 Standard	22 754 [0.38]	B	.148 3.76	.780 19.81	Red/ Green	.040-.080 1.02-2.03	Brass	.012 0.30	.016 0.41	55319-1	55319-3	—
.110 Low Insertion	16 2,800 [1.42]	B	.160 4.06	.821 20.85	Blue/ Blue	.064-.130 1.63-3.30	Brass	.016 0.41	.016 0.41	—	55318-3	—

Note: All part numbers are RoHS compliant.

PIDG FASTON Receptacles and Tabs (Continued)

Tooling for Insulated FASTON Receptacles and Tabs — 26 to 10 AWG Wire Range

Wire Size	Hand Tool	Tools for Tape Mounted Terminations			Tools for Strip Form Terminations
		Tape Dies for 69875 AMP-TAPETRONIC No Applicator Required	Tape Dies for AMP-O-LECTRIC ¹ Model "G" Applicator 567200-3	Tape Dies for AMPOMATOR CLS III G, CLS IV Applicator 687658-1	AMPOMATOR CLS III G, CLS IV Applicators
26-24	48518-2	69877-2	69877-2	69877-2	—
22-18	59824-1	59826-1	59826-1*	59826-1	466788-3 ²
22-18 (Natural)	90185-1	90248-2	90248-2	90248-2	466554-3
16-14	59824-1	59827-1	59827-1*	59827-1	466789-3 ²
14-12	90246-1	90240-2	90240-2	90240-2	—
12-10	59824-1	59828-1	59828-1*	59828-1	466790-4 ²

*Only UL and CSA approved.
¹AMP-O-LECTRIC Model "K" 565435-5 uses applicator 567200-2.
²Die included with applicator.

Positive Lock Receptacle
Low Insertion Force with Locking Device

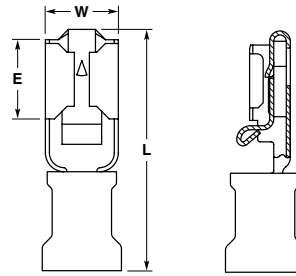

Description	Wire Range	Ins. Dia. Max.	Dimensions			Material and Finish	Part Number
			W	L	E		
For Tab .250 x .032	16-14	.190 4.83	.362 9.19	.850 21.59	.315 8.00	Tin Plated Brass	165536-1

Tab

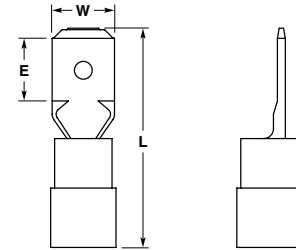

Description	Wire Range	Ins. Dia. Max.	Dimensions			Material and Finish	Part Number
			W	L	E		
For Receptacle .250 x .032	22-18	.157 3.99	.250 6.35	.866 22.00	.300 7.62	Tin Plated Brass	696362-1
	16-14	.197 5.00	.250 6.35	.866 22.00	.300 7.62	Tin Plated Brass	696369-1
	12-10	.256 6.50	.250 6.35	.950 24.13	.300 7.62	Tin Plated Brass	696372-1

PIDG FASTON Flag Receptacles

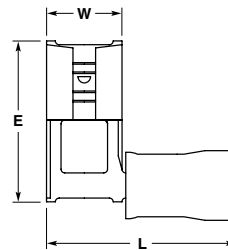

Description	Wire Range	Ins. Dia. Max.	Dimensions			Material and Finish	Part Number
			W	L	E		
For Tab .250 x .032	22-18	.134 3.40	.300 7.62	.720 18.29	.610 15.49	Tin Plated Brass	156667-1
	16-14	.157 3.99	.300 7.62	.720 18.29	.610 15.49	Tin Plated Brass	156666-1

Note: All part numbers are RoHS compliant.

PIDG FASTON Receptacles and Tabs (Continued)

Fully Insulated Receptacles

Insulation Sleeve — Nylon

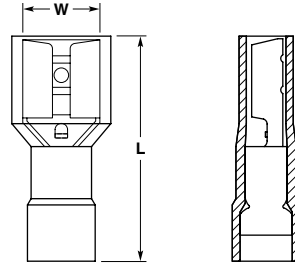

Description	Wire Range	Ins. Dia. Range	Dimensions		Material and Finish	Part Number
			W	L		
For Tab .250 x .032	22-18	.128 3.25	.375 9.53	.891 22.63	Tin Plated Brass	696357-1
	16-14	.165 4.19	.375 9.53	.881 22.38	Tin Plated Brass	696366-1
	12-10	.225 5.72	.375 9.53	.998 25.35	Tin Plated Brass	696371-1

Budget Line PIDG FASTON Receptacles

Material

Insulation — PVC, UL 94V-0

Receptacle Body — Brass

Plating — Tin

Metallic Sleeve — Copper

Plating — Tin

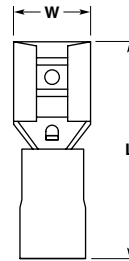

Series	Wire Size Circular Mils [mm ²]	Dimensions		Terminal Color	Wire Insulation Diameter Max.	Fits Tab Thk.	Part Numbers	
		W Nom.	L Nom.				Loose Piece	Tape Mounted
.250	22-18	.300 7.62	.819 20.80	Red	.150 3.81	.032 0.81	696301-1	696301-2
	16-14	.300 7.62	.819 20.80	Blue	.185 4.70	.032 0.81	696302-1	696302-2
	16-14	.300 7.62	.917 23.29	Yellow	.244 6.20	.032 0.81	696303-1	696303-2

Note: All part numbers are RoHS compliant.