

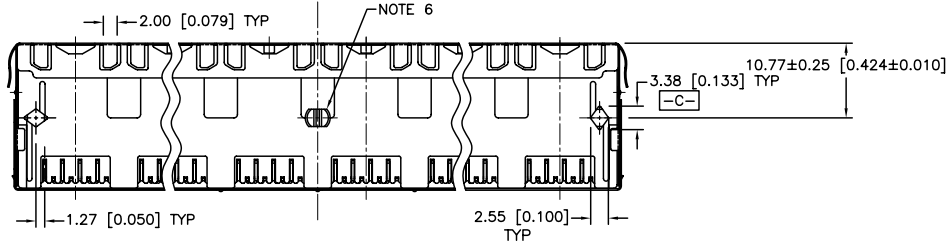
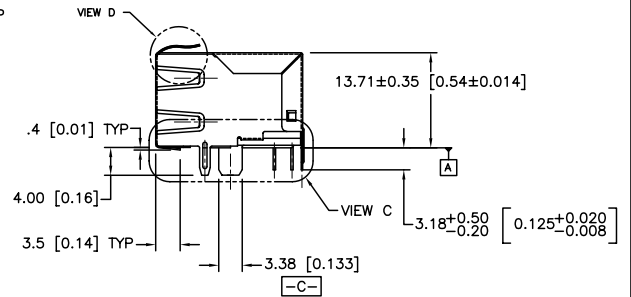
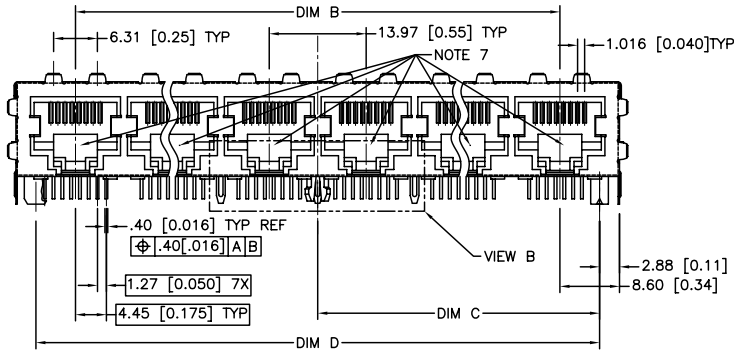
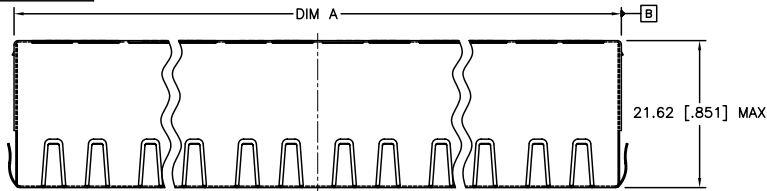

Tous droits strictement réservés. Reproduction ou communication à des tiers interdite sous quelque forme que ce soit sans autorisation écrite du propriétaire. Propriété de c FCI. Droits de reproduction FCI.

All rights strictly reserved. Reproduction or issue to third parties in any form whatever is not permitted without written authority from the proprietor. Property of FCI. Copyright FCI.

**FCI**

PRODUCT NO  
SEE TABLE



mat'l. code				tolerances unless otherwise specified		CUSTOMER COPY	 www.fciconnect.com	
ltr	ecn no	dr	date	linear	.xx ±.01/.X±.3			projection
B	V91281	LP	6/9/99		.xxx ±.005/.xx±.13		MPS SERIES, RJ45	
C	V92058	LP	10/20/99		.xxx ±.0020/.xxx±.051	 MM/INCH	product family MOD JACK	
D	V00653	CSP	7/17/00	angles	0° ±2°			code
E	V10984	BKB	3/13/01	dr	L.POTTEIGER 11/16/98	scale	size	sheet
F	V12561	LP	10/23/01	enfr	B.MARSHALL 11/16/98			
G	V03-1103	PJ	10/20/03	chr	B.MARSHALL 11/16/98		dwg no	
H	M05-0074	MHT	4/23/05	appd	B.MARSHALL 11/16/98		74839	
sheet	revision	H	G	H	G			
index	sheet	1	2	3	4	5		

cage code  
22526

ACAD

PDM: Rev:H

STATUS: Released

Printed: May 18, 2005

Tous droits strictement réservés. Reproduction ou communication à des tiers interdite sous quelque forme que ce soit sans autorisation écrite du propriétaire. Property of FCI. Droits de reproduction FCI.

**FCI**

All rights strictly reserved. Reproduction or issue to third parties in any form whatever is not permitted without written authority from the proprietor. Property of FCI. Copyright FCI.

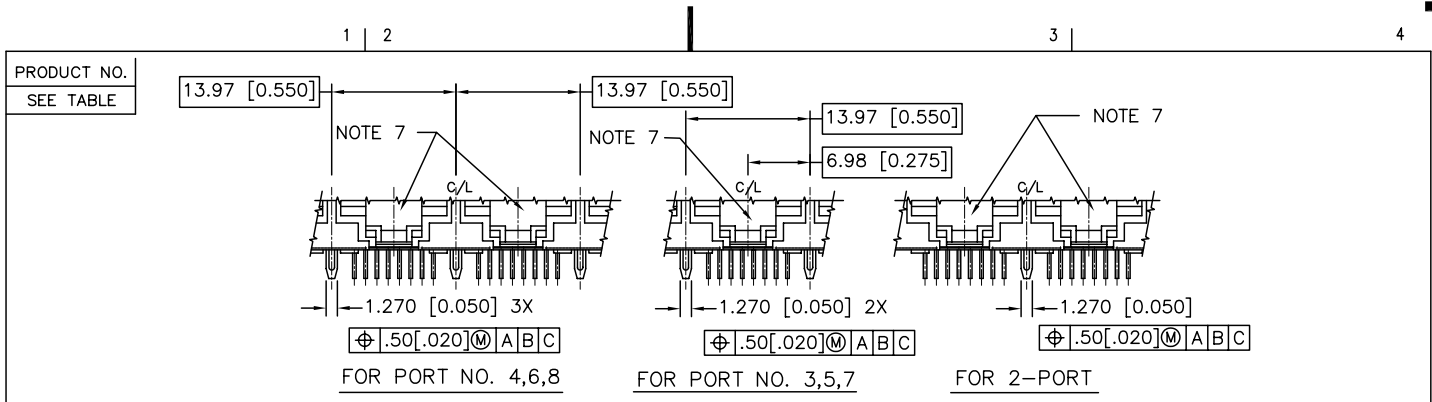

VIEW B  
(CENTER PEG OMITTED FOR CLARITY)

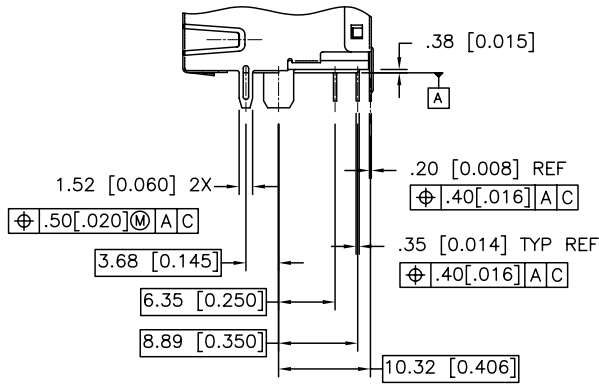

VIEW C

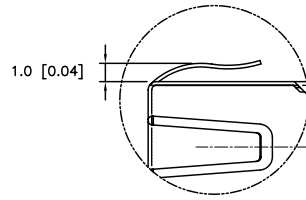

VIEW D  
SCALE: 2/1  
TYP FOR ALL GROUND SPRINGS

mat'l. code				tolerances unless otherwise specified				CUSTOMER COPY		 www.fciconnect.com	
ltr	ecn no	dr	date	linear	.xx ±.01/.X±.3		projection		title		
G					.xxx ±.005/.xx±.13				MPS SERIES, RJ45		
					.xxx ±.0020/.xxx±.051				THRU HOLE DIAMOND PEG ASSY		
					0° ±2°				product family MOD JACK		
				angles	0° ±2°		MM/INCH	size	code		
				dr	L.POTTEIGER	11/16/98	1:1	A	213		
				enrg	B.MARSHALL	11/16/98			sheet		
				chr	B.MARSHALL	11/16/98			2 of 5		
				appd	B.MARSHALL	11/16/98					
sheet index	revision sheet								cage code		
									22526		

ACAD

PDM: Rev:H

STATUS: Released

Printed: May 18, 2005

Tous droits strictement réservés. Reproduction ou communication à des tiers interdite sous quelque forme que ce soit sans autorisation écrite du propriétaire. Property of FCI. Droits de reproduction FCI.

All rights strictly reserved. Reproduction or issue to third parties in any form whatever is not permitted without written authority from the proprietor. Property of FCI. Copyright FCI.



1 | 2

3

4

PRODUCT NO. ⑥	NO. OF PORTS	DIM A <sup>+0.60</sup> <sub>-00</sub> [.024] [.000]	DIM B	DIM C <sup>±.10</sup> <sub>[±.004]</sub>	DIM D <sup>±.15</sup> <sub>[±.006]</sub>	DIM E <sup>±.13</sup> <sub>[±.005]</sub>
74839-X02Y	2	31.68 [1.247]	13.97 [0.550]	12.70 [0.500]	25.40 [1.000]	32.11 [1.264]
74839-X03Y	3	45.65 [1.797]	27.94 [1.010]	19.69 [0.775]	39.37 [1.550]	46.08 [1.814]
74839-X04Y	4	59.62 [2.347]	41.91 [1.650]	26.67 [1.050]	53.34 [2.100]	60.05 [2.364]
74839-X05Y	5	73.59 [2.897]	55.88 [2.200]	33.66 [1.325]	67.31 [2.650]	74.02 [2.914]
74839-X06Y	6	87.56 [3.447]	69.85 [2.750]	40.64 [1.600]	81.28 [3.200]	87.99 [3.464]
74839-X07Y	7	101.53 [3.997]	83.82 [3.300]	47.63 [1.875]	95.25 [3.750]	101.96 [4.014]
74839-X08Y	8	115.50 [4.547]	97.79 [3.850]	54.61 [2.150]	109.22 [4.300]	115.93 [4.564]

NOTE: PLEASE CHECK FOR AVAILABILITY, NOT ALL OPTIONS AVAILABLE.

SPRING OPTION Y	DESCRIPTION (SEE SHEET 5 FOR OPTIONAL VIEWS)
1	SPRING ON TOP,BOTTOM AND BOTH SIDES
2	NO SPRINGS
3	SPRINGS ON TOP AND BOTTOM
4	SPRINGS ON TOP,BOTTOM AND 1 PER SIDE (STAGGERED)
5	SAME AS OPTION 4 EXCEPT OPPOSITE STAGGER

NOTES:

- HOUSING MATL: HIGH TEMP. THERMOPLASTIC, COLOR BLACK, UL94V-0.
- CONTACT MATL: COPPER ALLOY  
MATING AREA PLATING: Au OVER Ni., (SEE TABLE).  
SOLDER AREA PLATING: 2.54uM/100u" MIN TIN LEAD OVER Ni.  
**LEAD FREE OPTION:**  
SOLDER AREA PLATING: 2.54uM/100u" MIN PURE TIN OVER Ni.
- SHIELDING MAT'L: TIN PLATED COPPER ALLOY.
- ALL DIMENSIONS IN MILLIMETERS AND INCHES.
- SEE SHEET 5 FOR GROUND TAB CONFIGURATION.
- CENTER PEG FOR 8 PORT ONLY.
- COMPANY LOGO LOCATED IN THIS AREA.
- ADD LF SUFFIX AT THE END OF PART NUMBER FOR LEAD FREE OPTION.
- THE HOUSING WILL WITHSTAND EXPOSURE TO 260°C PEAK TEMPERATURE FOR 15 SECONDS IN A WAVE SOLDER APPLICATION WITH A 1.5mm MINIMUM THICK CIRCUIT BOARD. SEE APPLICATION NOTES/PROCEDURES IF THEY ARE AVAILABLE.
- THIS PRODUCT MEETS EUROPEAN UNION DIRECTIVES AND OTHER COUNTRY REGULATION AS DESCRIBED IN GS-22-008.
- PLATING OPTIONS:  
MAY BE EITHER GOLD OR GXT PLATED AT MANUFACTURER'S OPTION.

PLATING CODE X	PLATING ⑪
0	.76uM/30u" G.X.T.
3	.76uM/30u" GOLD
5	1.27uM/50u" GOLD

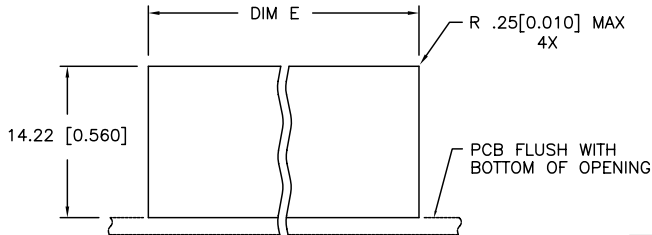

RECOMMENDED PANEL OPENING

mat'l. code				tolerances unless otherwise specified		CUSTOMER COPY		FCI www.fciconnect.com	
ltr	ecn no	dr	date	linear	angles	projection	title	product family	MOD JACK
H				.XX ±.01/.XX±.3	0° ±2°	⊕	MPS SERIES, RJ45 THRU HOLE DIAMOND PEG ASSY	code 213	sheet 3 of 5
				.XXX ±.005/.XX±.13		MM/INCH	size	dwg no	
				.XXX ±.0020/.XXX±.051		scale	A	74839	
						1:1			
sheet index	revision sheet								

1 | 2

3

4

ACAD

PDM: Rev:H

STATUS: Released

Printed: May 18, 200

cage code 22526

Tous droits strictement réservés. Reproduction ou communication à des tiers interdite sous quelque forme que ce soit sans autorisation écrite du propriétaire. Property of FCI. Droits de reproduction FCI.

All rights strictly reserved. Reproduction or issue to third parties in any form whatever is not permitted without written authority from the proprietor. Property of FCI. Copyright FCI.

PRODUCT NO.  
SEE TABLE

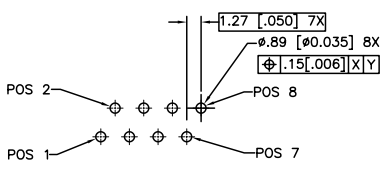

VIEW C  
SCALE 2/1  
TYPICAL FOOTPRINT

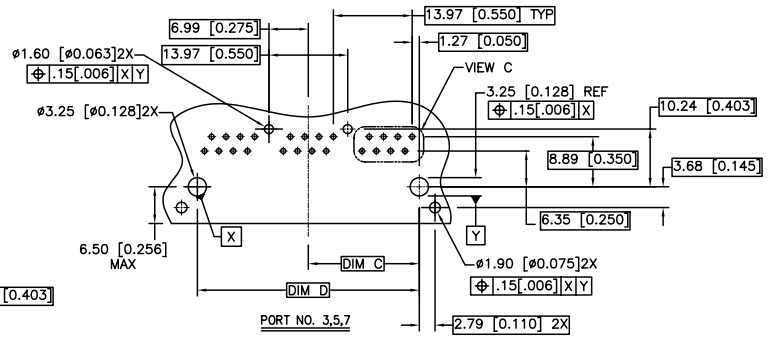
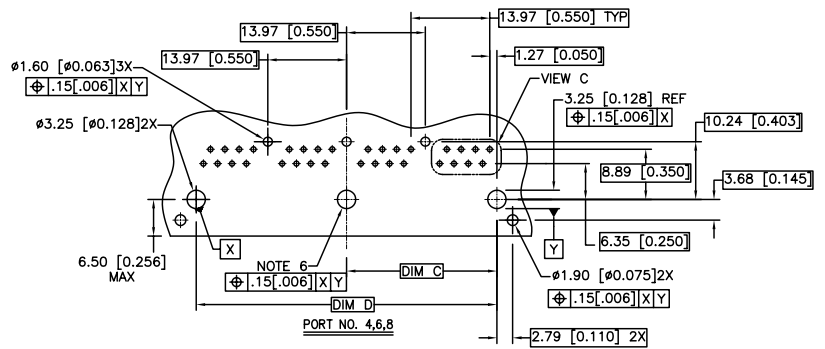

RECOMMENDED P.C.B LAYOUT  
AS VIEWED FROM TOP SIDE (COMPONENT SIDE)

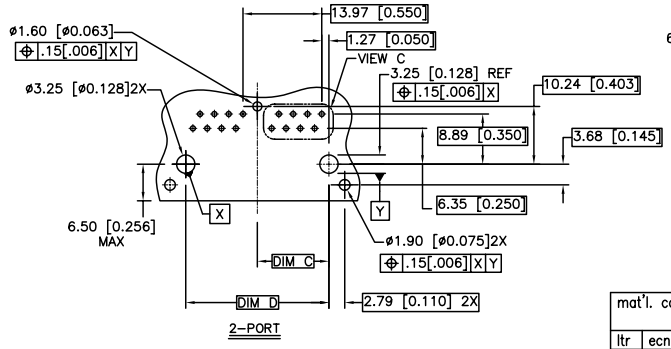

2-PORT

mat'l. code		tolerances unless otherwise specified		CUSTOMER COPY		FCI		www.fciconnect.com	
ltr	ecn no	dr	date	linear	.xx ±.01/.X±.3	projection	title	MPS SERIES, RJ45	code
G					.xxx ±.005/.xx±.13	MM/INCH	THRU HOLE DIAMOND PEG ASSY	MOD JACK	213
				angles	.xxx ±.0020/.xxx±.051	scale	product family	size	sheet
				dr	0° ±2°	1:1	74839	dwg no	4 of 5
				engr	L.POTTEIGER 11/16/98				
				chr	B.MARSHALL 11/16/98				
				appd	B.MARSHALL 11/16/98				
sheet index	revision sheet								

ACAD

PDM: Rev:H

STATUS: Released

cage code  
22526  
Printed: May 18, 2005

1 | 2

3 |

4

PRODUCT NO  
SEE TABLE

# SPRING TAB CONFIGURATION

## OPTION Y

NOTE 7

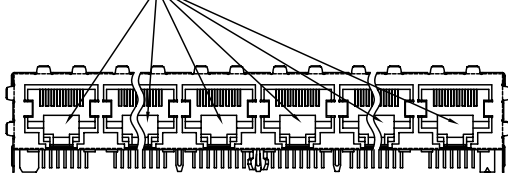

SPRING OPTION 1

NOTE 7

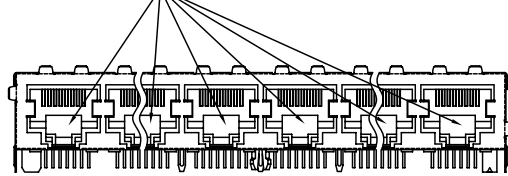

SPRING OPTION 4

NOTE 7

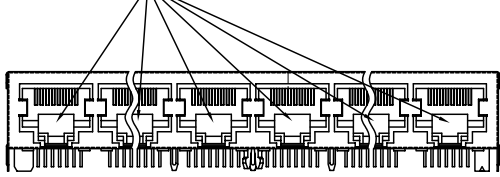

SPRING OPTION 2

NOTE 7

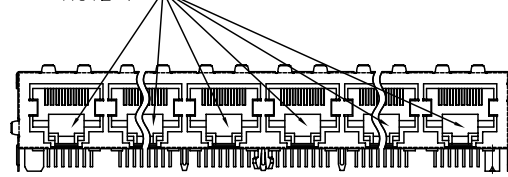

SPRING OPTION 5

NOTE 7

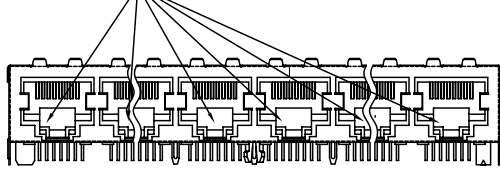



SPRING OPTION 3

1 | 2

3 |

4

mat'l. code		tolerances unless otherwise specified		CUSTOMER COPY		 www.fciconnect.com	
ltr	ecn no	dr	date	linear	.XX ±.01/.X±.3	projection	title
G					.XXX ±.005/.XX±.13	 MM/INCH	MPS SERIES, RJ45
				angles	.XXX ±.0020/.XXX±.051		THRU HOLE DIAMOND PEG ASSY
				dr	0° ±2°	scale	product family MOD JACK
				engr	L.POTTEIGER 11/16/98	1:1	code
				chr	B.MARSHALL 11/16/98		213
				appd	B.MARSHALL 11/16/98		sheet
sheet index	revision sheet						5 of 5

ACAD

PDM: Rev:H

STATUS: Released

cage code  
22526

Printed: May 18, 2005

Tous droits strictement réservés. Reproduction ou communication à des tiers interdite sous quelque forme que ce soit sans autorisation écrite du propriétaire. Propriété de c FCI. Droits de reproduction FCI.

FCI

All rights strictly reserved. Reproduction or issue to third parties in any form whatever is not permitted without written authority from the proprietor. Property of FCI. Copyright FCI.