

# MODULAR JACKS



**Amphenol**<sup>®</sup>  
www.rjvista.com

# Contents

Amphenol Data/Telecom Products Group of Amphenol Canada Corp., a subsidiary of Amphenol Corporation, is an ISO 9001 certified facility located in Toronto, Canada. Our activities are dedicated to the design, development and manufacture of interconnect products intended for use in the data communications and telecommunications markets. Our expertise in understanding and supporting our customers' interconnect needs has earned Amphenol Canada a

reputation of quality and excellence among the world's leading users of electronic components.

This Modular Jack catalog represents some of our more popular products within this product category. Other product categories include, but are not limited to: D-Sub, Micro-Ribbon, USB, RF, Fiber-Optic, DIN 41612, mini-DIN, Headers and Sockets, Firewire, SCSI, VHDCI and Filtered Connector products.

## *RJ Vista*

**EMI Quiet with LEDs**

**Single Port**

**Multi Port**

**RJSS**

**Stacked**

<b>RJHS</b>	<b>1-2</b>
<b>RJHS</b>	<b>3-4</b>
<b>RJHS</b>	<b>5-6</b>
<b>RJSS</b>	<b>7-8</b>
<b>RJSA</b>	<b>9-10</b>

## *Filtered & Shielded*

**Single Port**

**Multi Port**

<b>FRJ/FRJA</b>	<b>11-12</b>
<b>FRJA</b>	<b>13</b>

## *EMI Quiet*

**6 Position**

<b>RJ01</b>	<b>14-15</b>
-------------	--------------

## *Right Angle*

**Single Port High Profile**

**Single Port Low Profile**

**Single Port Ultra Low Profile**

**Multi Port Full Shield**

<b>RJA02</b>	<b>16</b>
<b>RJA03</b>	<b>17</b>
<b>RJA05</b>	<b>18</b>
<b>RJA09</b>	<b>19-20</b>

## *Top Entry*

**Single Port Slim Profile**

**Single Port Standard Profile**

<b>RJA06</b>	<b>21</b>
<b>RJA08</b>	<b>22</b>

## *Surface Mount*

**Single Port**

**Single Port Low Profile**

<b>RJA07</b>	<b>23-24</b>
<b>RJA15</b>	<b>25</b>

NOTICE: Specifications are subject to change without notice. Contact your nearest Amphenol sales office for the latest specifications. All statements, information and data given herein are believed to be accurate and reliable, but are presented without guarantee, warranty, or responsibility of any kind, expressed or implied. Statements or suggestions

concerning possible use of our products are made without representation or warranty that any such use is free of patent infringement, and are not recommended to infringe any patent. The user should not assume that all safety measures are indicated or that other measures may not be required. Amphenol and RJ vista are registered trademarks.

# RJHS Series

**RJ**vista™

EMI QUIET - WITH LEDS

## EMI Quiet Modular Jacks with LED's

**RJ**vista™

is a family of EMI Quiet Modular Jack Connectors with built-in LEDs, meets Ethernet CAT 5 performance. This product is ideal for LAN applications such as adapter cards and routers. Shielded and non-shielded versions are available, with a variety of LED colors, and ports.

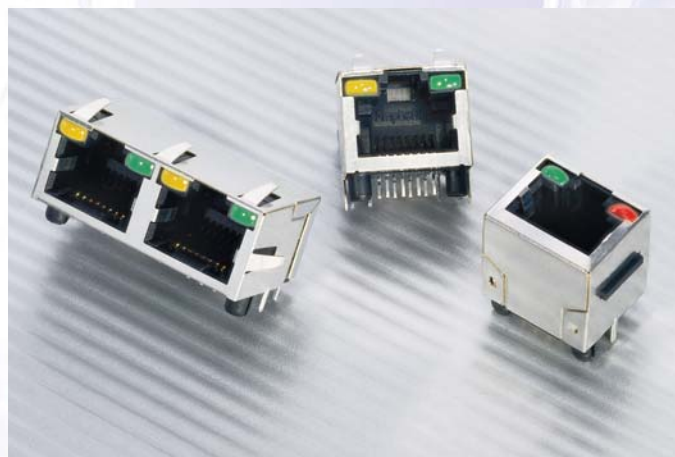

## Specifications

### MATERIAL

**Shield:** Copper Alloy; Tin/Lead Plated  
**Contacts:** Phosphor Bronze; Gold over Nickel  
**Insert:** Solder reflow process compatible (Complies with UL 94V-0)

### ELECTRICAL

**Contact Resistance:** 20 milliohms maximum  
**Insulation Resistance:** 500 megohms minimum  
**Current Rating:** 1.5 Amps  
**Voltage Rating:** 125 Volts AC  
**Dielectric Withstanding Voltage:** 1000 VAC, RMS. 60 Hz. 1 min.

### Standard LEDs: For 5.0 V Systems

**Forward Voltage:** 2.1 Volts Typical  
**Reverse Voltage:** 6.0 Volts minimum  
**Luminous Intensity:** 0.5 mCd minimum (at If=2mA)

### Low Current LEDs: For 3.3 V Systems

**Forward Voltage:** 2.0 Volts Typical  
**Reverse Voltage:** 6.0 Volts minimum  
**Luminous Intensity:** 1.0 mCd minimum (at If=2mA)

### Other Parameters:

**Storage Temperature:** -20° C to 85° C  
**Lead Soldering Temperature:** 260° C (5 sec)  
**Plating on Tails:** Tin-Lead (90-10) alloy  
**UL File # :** E135615  
**CSA File # :** LR68598

## Ordering Information

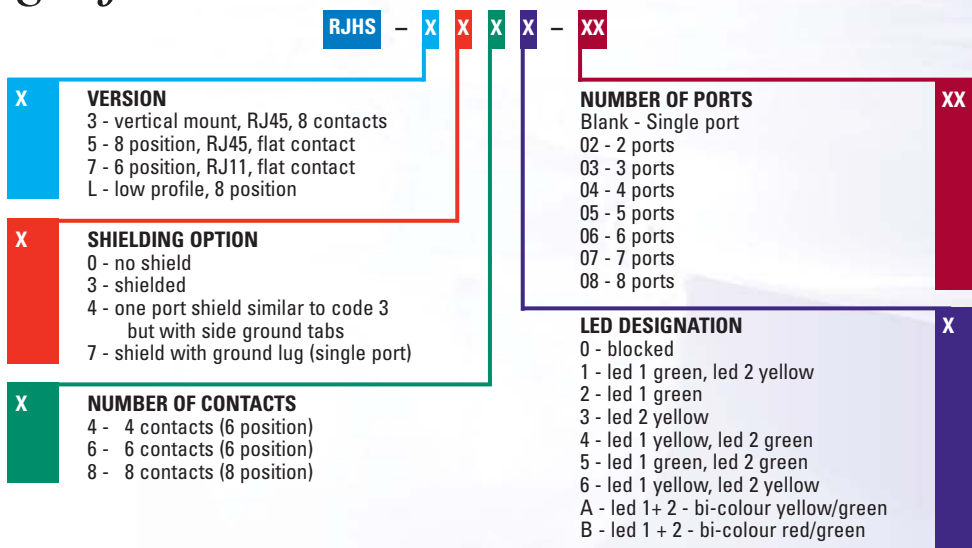

Options for style, shield & contacts available.  
 Contact Amphenol Canada for more information

For additional colour combinations  
 refer to Chart RJHS Page 2

# RJHS Series

RJ  
v<sub>ista</sub>

EMI QUIET - WITH LEDS

## LED Designation

RJHS - 538 1\* - 08

### \* LED DESIGNATION CODE

LED CODE	LED 2 Left	LED 1 Right
0	Blocked	Blocked
1	Yellow	Green
2	Blocked	Green
3	Yellow	Blocked
4	Green	Yellow
5	Green	Green
6	Yellow	Yellow
7	Red	Green
8	Green	Red
9	Green	Blocked
A	BiC Gr/YI	BiC Gr/YI
B	BiC Rd/Gr	BiC Rd/Gr
C	BiC Rd/Gr	BiC Gr/YI
D	Green	BiC Gr/YI
E	Yellow	BiC Gr/YI
F	BiC Gr/YI	Yellow
G	BiC Gr/Or	BiC Gr/Or
H	BiC Gr/YI	Green
J	BiC Rd/Gr	Yellow
K	Yellow	BiC Gr/Or
L	BiC Rd/Gr	Red
M	Red	Yellow
N	BiC Gr/Rd	BiC Gr/YI
P	Green	BiC Rd/Gr
R	BiC Gr/Or	Green
T	Red	Red
V	BiC Rd/Gr	Green
W	Special Designation (add digit to part number)	
Z		

RJHS - 538W - 08 2\*

### \* SPECIAL LED DESIGNATION

SPECIAL DESIGNATION	LED 2 Left	LED 1 Right
0	See standard Design	
1	Red	Blocked
2	BiC Gr/YI	Yellow
3	Yellow	Red
4	Blocked	Red
5	Blocked	Yellow
6	Red	BiC Gr/YI
7		
8		
9		

### LOW CURRENT LED OPTIONS

A	Yellow	Yellow
B	Yellow	Green
C	Green	Yellow
D	Green	Green

LED 2

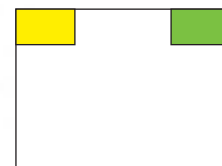

LED 1

\* Contact Amphenol Canada for more information

# RJHS Series



EMI QUIET - WITH LEDS

## Single Port

### NON-SHIELDED

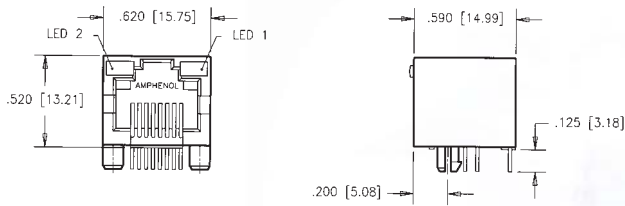

### PCB LAYOUT

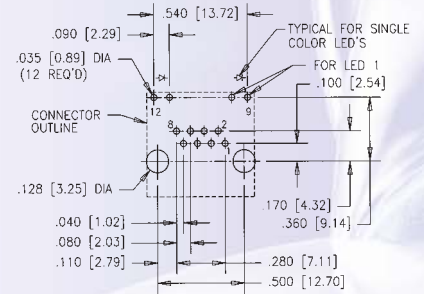

### BI-COLOUR LEDS

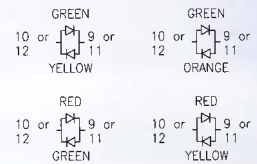

### SHIELDED WITH TOP & SIDE GROUND TABS

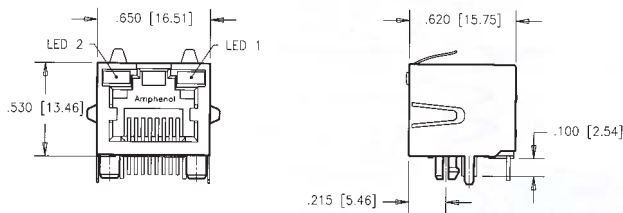

### PCB LAYOUT

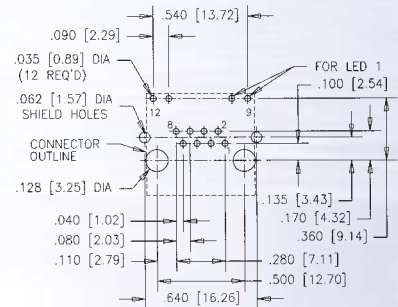

### SHIELDED WITH GROUND LUG

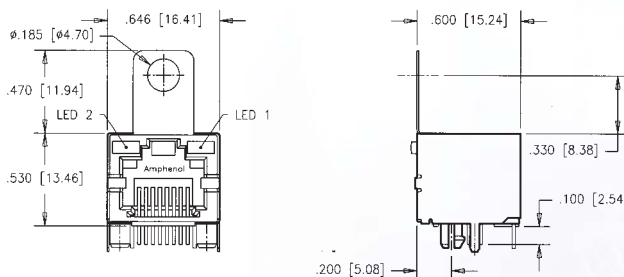

### PCB LAYOUT

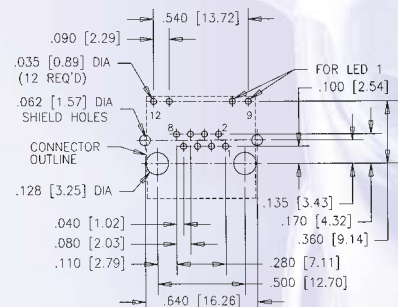

# RJHS Series

RJvista™

EMI QUIET - WITH LEDS

## VERTICAL MOUNT SINGLE PORT ONLY

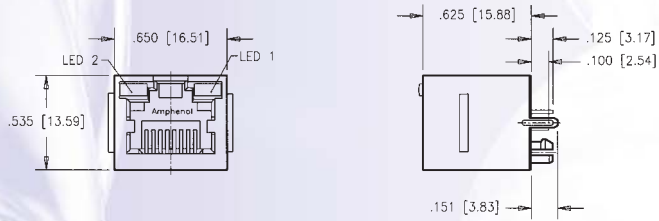

## PCB LAYOUT

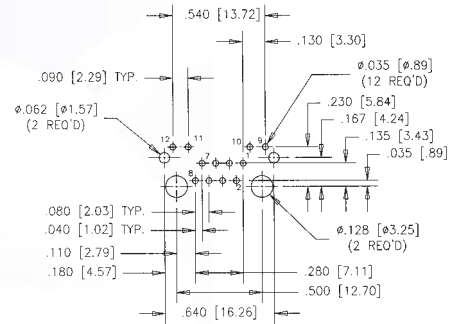

## LOW PROFILE SINGLE & 2 PORT

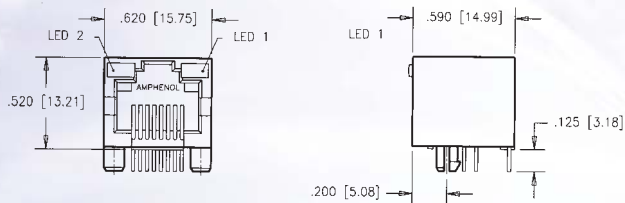

## PCB LAYOUT

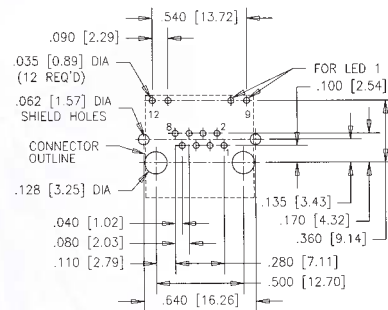

## SHORTING BARS SINGLE & 2 PORT

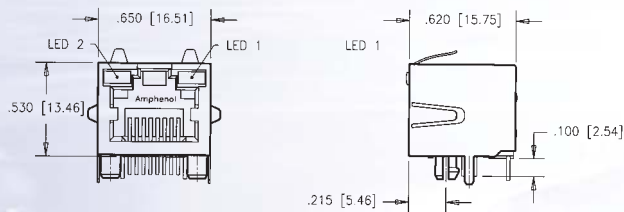

## PCB LAYOUT

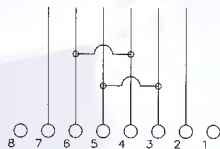
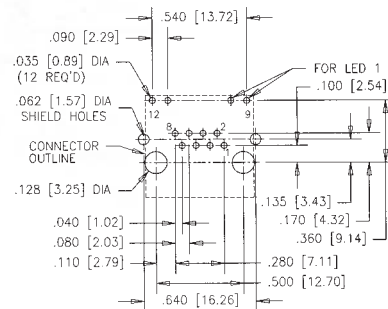

SHORTING BARS (CIRCUIT)

## EMI Quiet Modular Jacks with LED's Multiport

RJ vista™ is a family of EMI Quiet Modular Jack Connectors with built-in LEDs, designed for Category 5 ethernet performance. This product is ideal for LAN applications such as adapter cards and routers. Shielded and non-shielded versions are available, with a variety of LED colors, and ports.



### SHIELDED 2 PORT

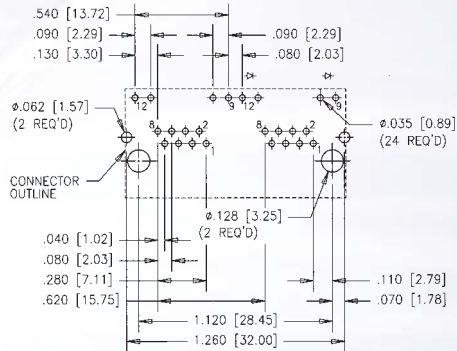
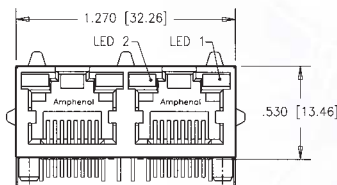

### SHIELDED 3 PORT

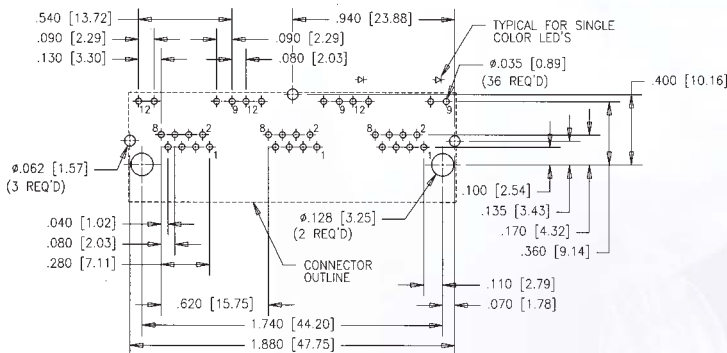
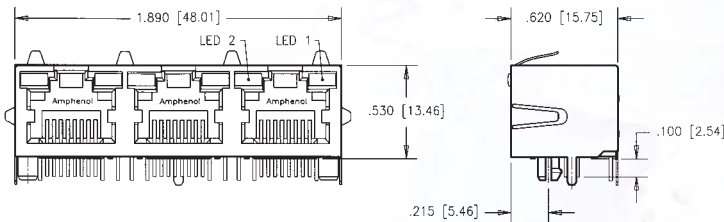

# RJHS Series

RJ  
vista™

EMI QUIET - WITH LEDS

SHIELDED WITH TOP AND SIDE GROUND TABS (AVAILABLE IN MULTI-PORT)

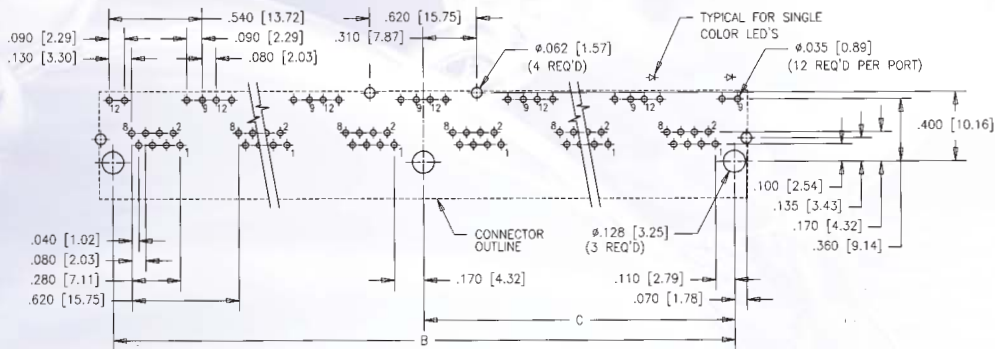
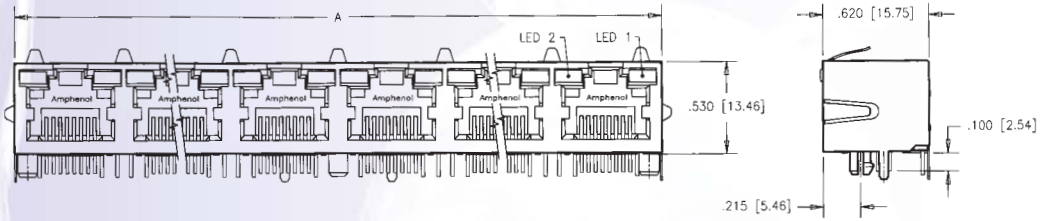

Number of ports	A	B	C
2	see page 5	see page 5	see page 5
3	see page 5	see page 5	see page 5
4	2.510[63.75]	2.360[59.94]	1.180[29.97]
6	3.750[95.25]	3.600[91.44]	1.800[45.72]
8	4.990[126.75]	4.840[122.94]	2.420[61.47]



## RJSS: SMT Connector with Light Pipes

Amphenol Canada's RJSS series represents an expansion of our current RJHS series connector. The RJSS offers all the benefits of the RJHS series in SMT. This connector meets Cat 5 Ethernet Performance.

Shielded and unshielded versions are available with or without light pipe option.



## Specifications

### MATERIAL

<b>Shield:</b>	Copper Alloy; Tin/Lead Plated
<b>Contacts:</b>	Phosphor Bronze; Gold Plated over Nickel on mating area, Tin lead on the terminals
<b>Insert:</b>	Phosphor Bronze; Gold over Nickel (Complies with UL 94V-0)

### ELECTRICAL

<b>Contact Resistance:</b>	20 milliohms maximum
<b>Insulation Resistance:</b>	500 megohms minimum
<b>Current Rating:</b>	1.5 Amps
<b>Voltage Rating:</b>	125 Volts AC
<b>Dielectric Withstanding Voltage:</b>	1500 VAC, RMS. 60 Hz. 1 min.
<b>Other Parameters:</b>	
Storage Temperature:	-20°C to +85°C
Plating on Tails:	Tin/Lead (90-10) Alloy

## Ordering Information

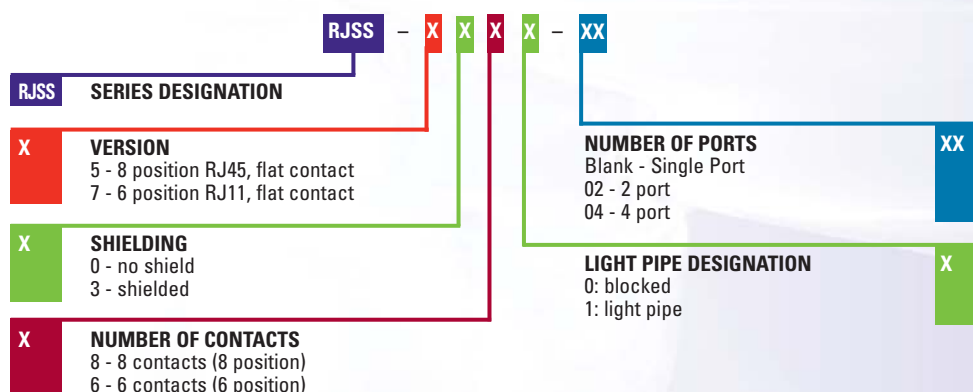

# RJSS Series

## SMT CONNECTOR

### Single Port

RJSS - 5381

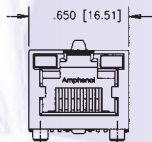

SHIELD WITH TOP GROUND TAB  
LIGHT PIPE OPTIONAL

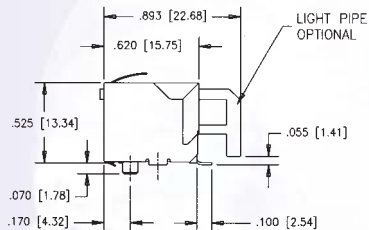

PCB LAYOUT

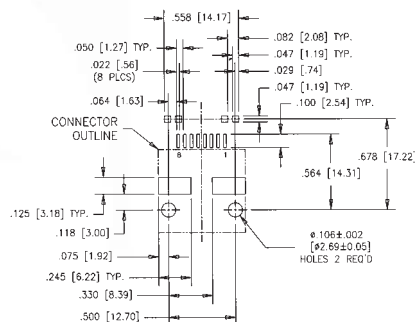

### 2 Port

RJSS - 5381 - 02

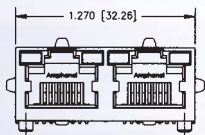

SHIELD WITH TOP AND SIDE GROUND TAB  
LIGHT PIPE OPTIONAL

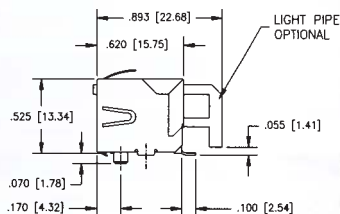

PCB LAYOUT

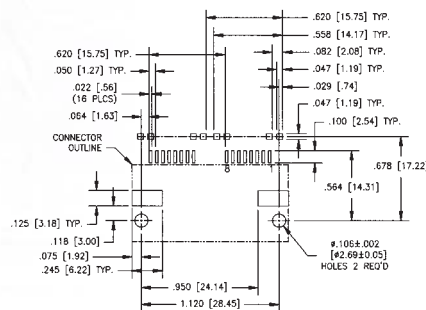

### 4 Port

RJSS - 5381 - 04

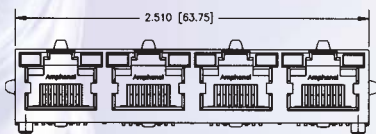

SHIELD WITH TOP AND SIDE GROUND TAB  
LIGHT PIPE OPTIONAL

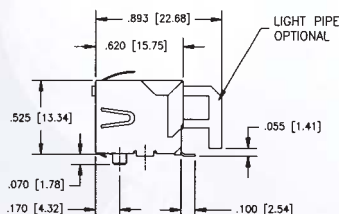

PCB LAYOUT

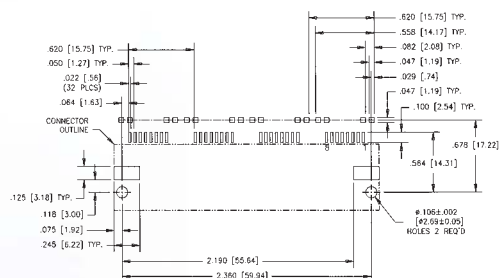

## Amphenol RJ45 Stackable

Reduces component and labour costs by incorporating LED's into the connector.

Meets Ethernet CAT 5 Performance

Stackable feature enables more ports with same board space.

For superior EMI performance, the option of configuring your connector with a ferrite filter is available.

Amphenol offers a wide variety of options:

- Ferrite filter
- Shielded & unshielded versions
- Variety of LED combinations
- Variety of ports



## Specifications

### MATERIAL

Please refer to RJHS specifications on page 1.

### ELECTRICAL

UL File #: E135615

CSA File #: 150190

## Impedance Characteristics

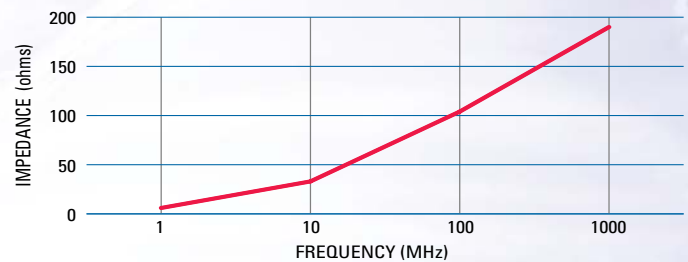

## Ordering Information

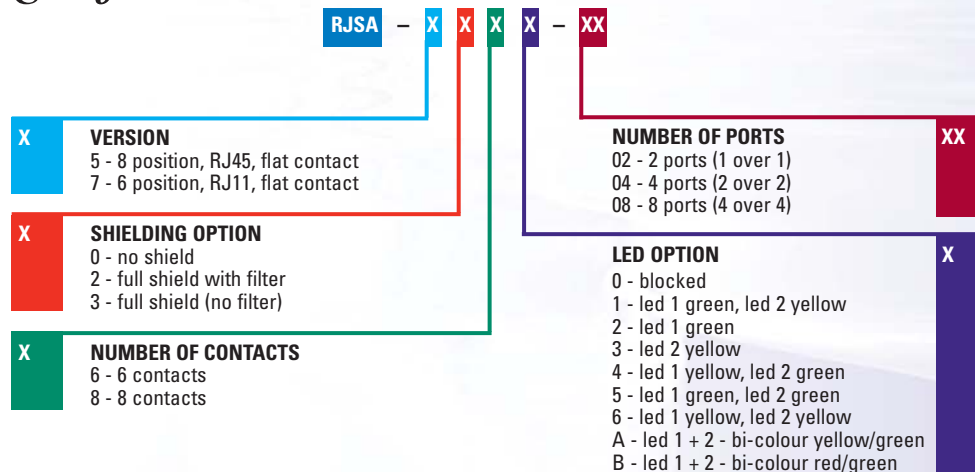

\* Filtering available - Please contact Amphenol for more information  
\*\* additional LED codes available - see page 2

# RJSA Series

STACKED RJ VISTA™

## 2x1 RJ45/RJ11

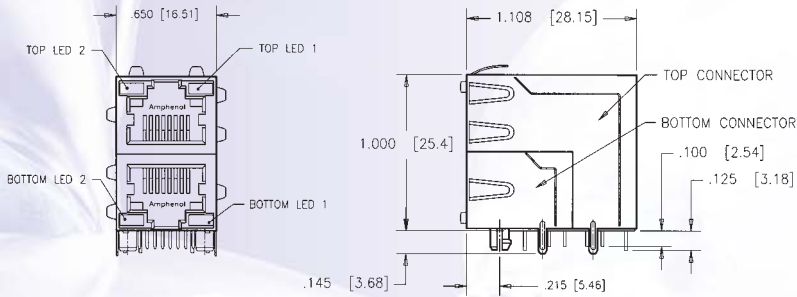

## PCB LAYOUT

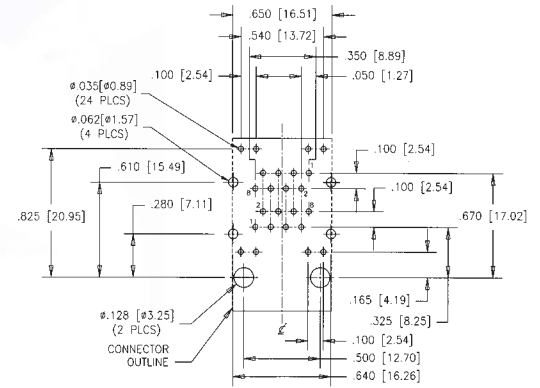

## 2X4 RJ45/RJ11

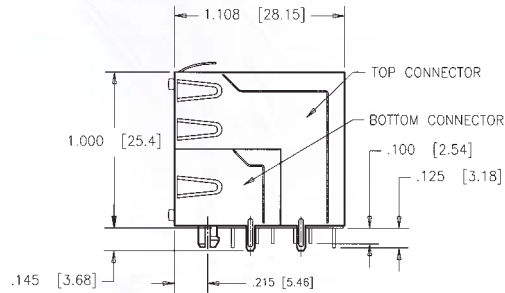
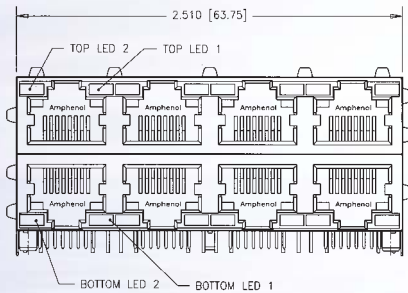

## PCB LAYOUT

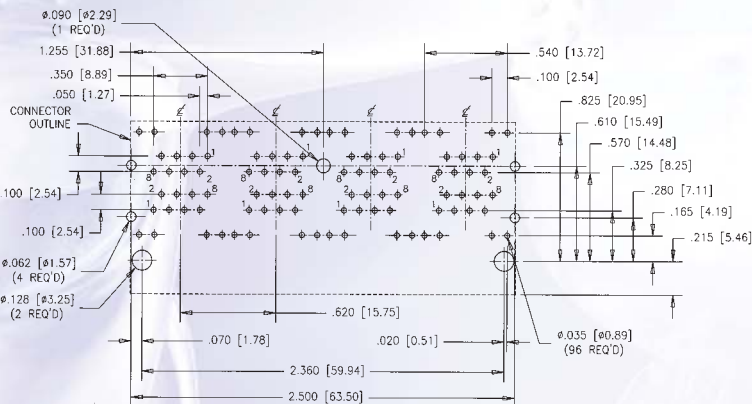

## ASSEMBLY

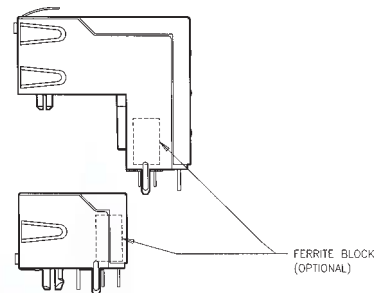

STACKABLE MODULAR JACK ASSEMBLY

# FRJ/FRJA Series

FILTERED & SHIELDED

## Modular Jack with Superior EMI Performance

The FRJ and FRJA series of shielded and filtered modular jacks offer low cost and effective EMC control within standard RJ-11 and RJ-45 connector footprints. EMC control is offered by a completely shielded connector and/or with the use of a high resistivity, high impedance ferrite block. No board layout changes are required for its use. Simply replace the standard non-filtered connector for superior EMC performance.

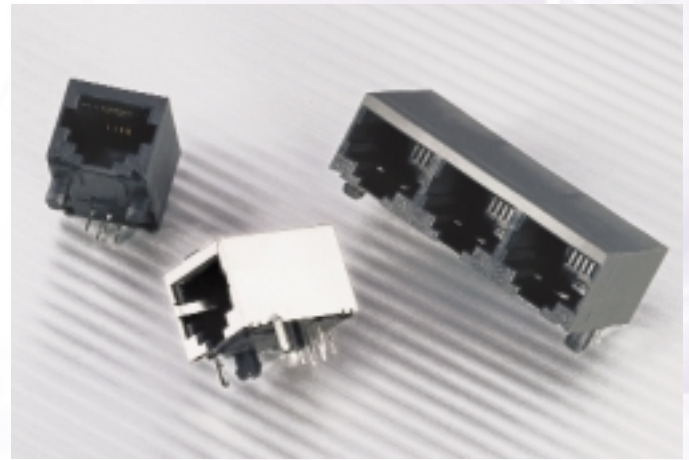

## Specifications

### MATERIAL

Shield:	Copper Alloy; Tin/Lead Plated
Contacts:	Phosphor Bronze; Gold over 30μ inches (0.76 microns) over Ni
Insert:	For FRJ, High Temperature Resistant Nylon. For FRJA, Thermoplastic Polyester (Complies with UL 94V-0)
Filter:	High Impedance, High Resistivity, Ferrite Block

### ELECTRICAL

Contact Resistance:	20 Milliohms maximum
Insulation Resistance:	500 Megaohms minimum
Current Rating:	1.5 Amps
Voltage Rating:	125 Volts AC
UL File # :	E135615
CSA File #:	LR68598

## Impedance Characteristics

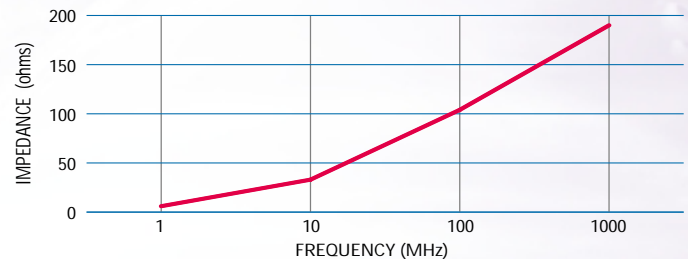

## 6 Position Filtered - High Profile

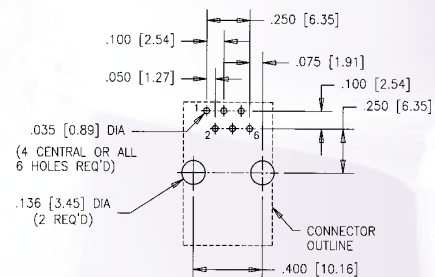
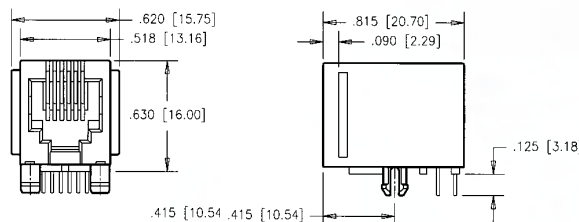

### 4 Contacts:

Standard Jack:	FRJ-104
Filtered:	FRJ-144

### 6 Contacts:

Standard Jack:	FRJ-106
Filtered:	FRJ-146

# FRJA Series

FILTERED & SHIELDED

## Ordering Information

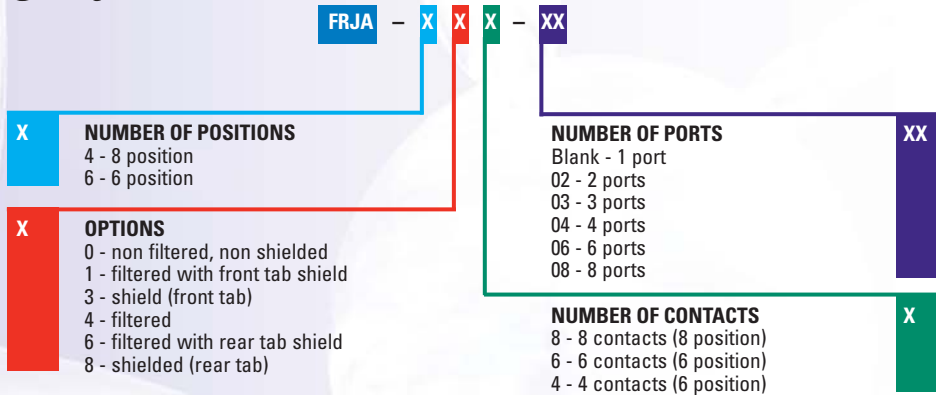

### PCB LAYOUT

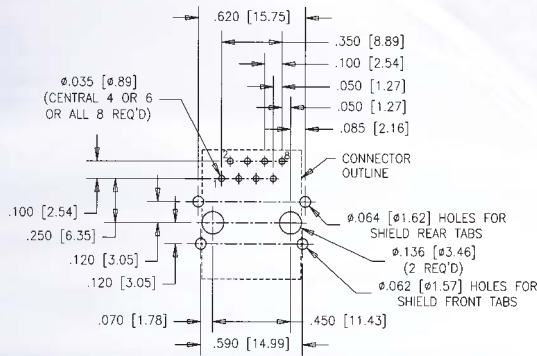

## Single Port (8 & 6 position)

### NON-SHIELDED

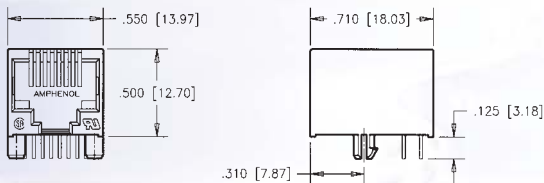

### SHIELDED

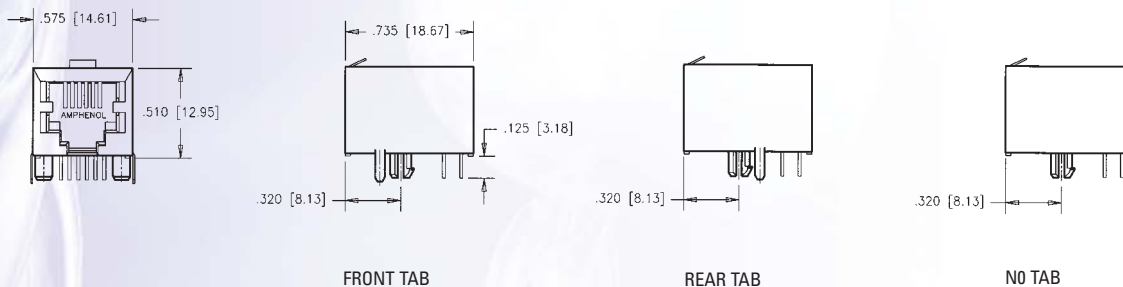

## Multi Port (8 & 6 position)

### NON-SHIELDED

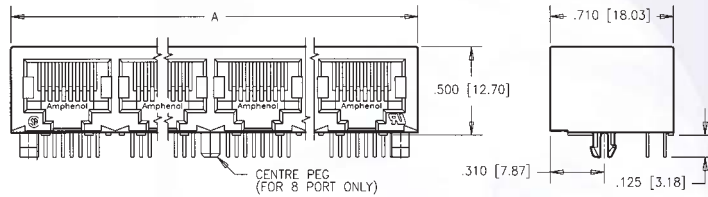

### SHIELDED

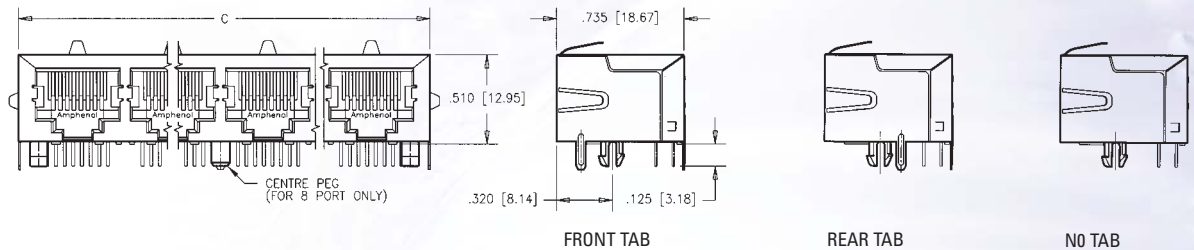

### PCB LAYOUT

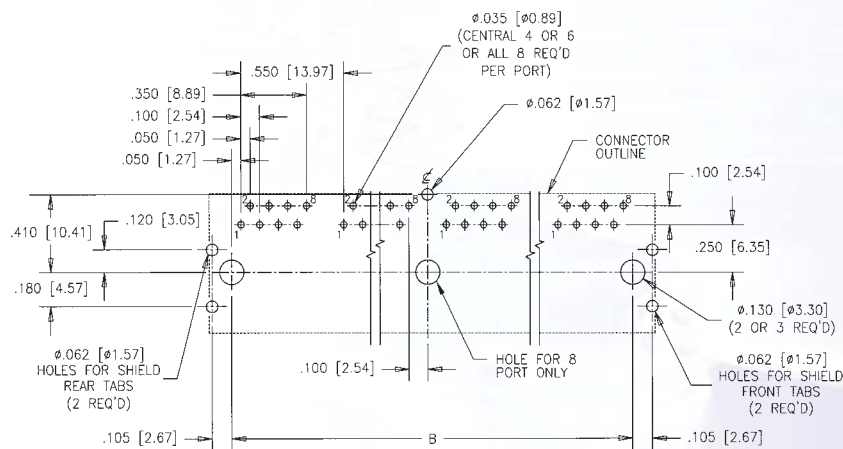

Number of ports	A	B	C
2	1.200[30.48]	1.000[25.40]	1.230[31.24]
4	2.300[58.42]	2.100[53.34]	2.330[59.18]
6	3.400[86.36]	3.200[81.28]	3.430[87.12]
8	4.500[114.30]	4.300[109.22]	4.530[115.06]

# RJ01 Series

EMI QUIET - 6 POSITION

MODEM CONNECTORS

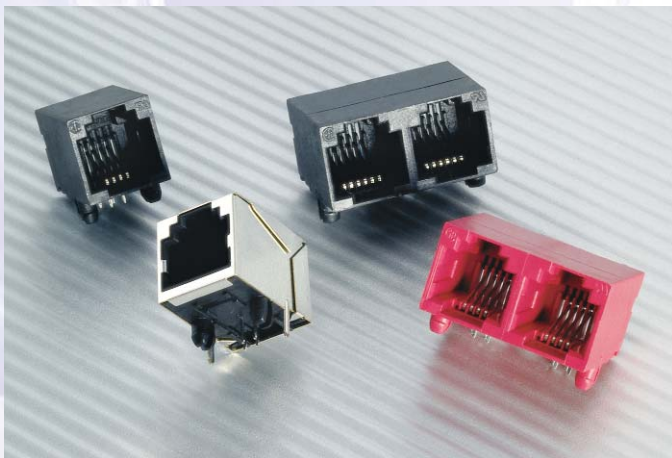

## Modular Jack with Superior EMI Performance

The RJ01 series of 6-position jacks are designed for superior EMI performance. The inverted connector provides shorter leads, eliminating the EMI antenna effect of the standard connector footprint. Typical performance improvement over their standard connector counterparts is 5-10 dB over the frequency range.

## Specifications

### MATERIAL

<b>Housing:</b>	High Temperature Resistant Nylon Flammability rating UL94V-0
<b>Contacts:</b>	Phosphor Bronze
<b>Contact Plating:</b>	50 $\mu$ inches (1.27 microns) Gold Over Nickel On Mating Area, Tin-Lead Alloy On Tails

**Shield:** Copper Alloy, Tin-Lead Alloy Plated

### ELECTRICAL

<b>UL#</b>	EI35615
<b>CSA#</b>	LR68598
<b>EN#</b>	60950

## Ordering Information

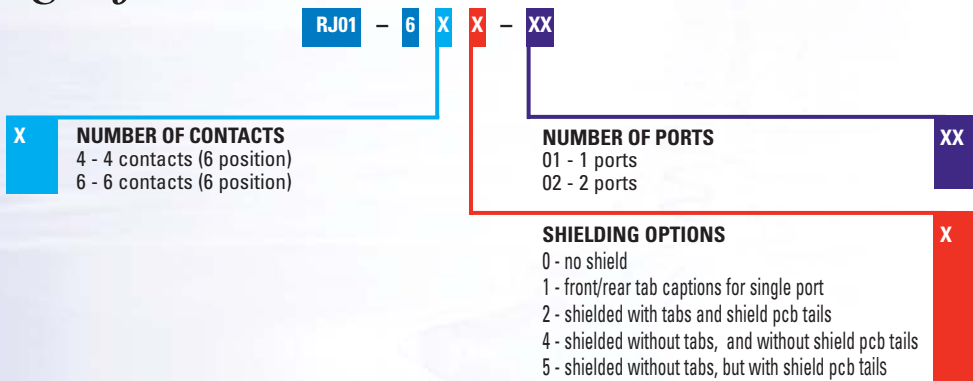

### PCB LAYOUT SINGLE PORT

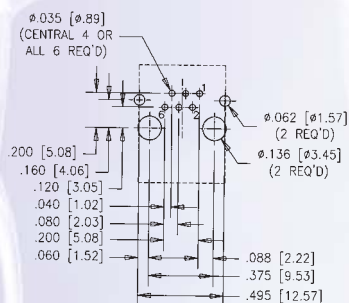

### PCB LAYOUT 2 PORT

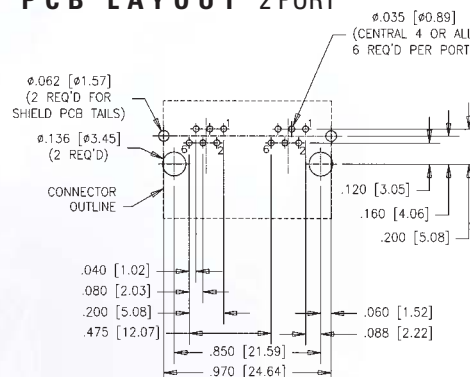



# RJ01 Series

EMI QUIET - 6 POSITION

## Single Port

### NON-SHIELDED

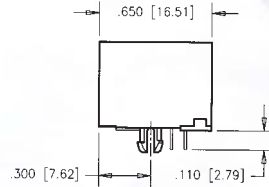
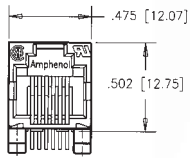

## 2 Port

### NON-SHIELDED

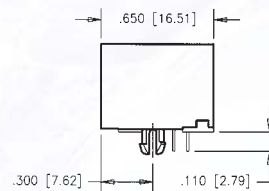
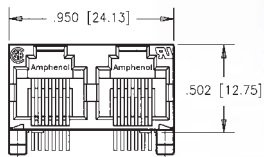

### SHIELDED

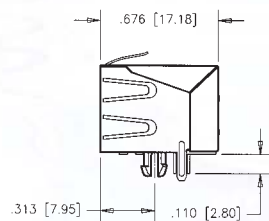
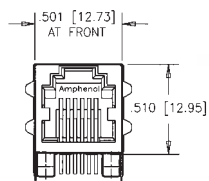

### SHIELDED

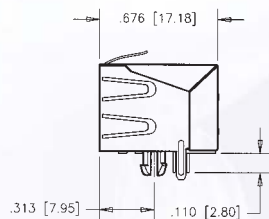
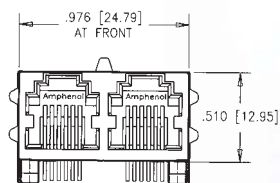

# RJA02 Series

HIGH PROFILE - SINGLE PORT

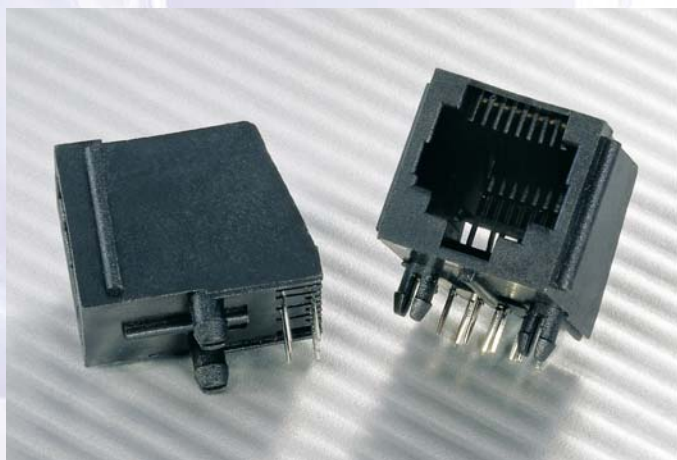

## Specifications

### MATERIAL

**Housing:** High Strength Thermoplastic Polyester Flammability Rating UL94V-0

**Contacts:** Phosphor Bronze

**Contact Plating:** Gold Over Nickel On Mating Area, Tin-Lead Alloy On Tails

### ELECTRICAL

**UL File # :** E136228

## Ordering Information

RJA02 - 1 X X - 0 X X 0

**X NUMBER OF POSITIONS**

8 - 8 position  
6 - 6 position  
4 - 4 position

**X NUMBER OF CONTACTS**

8 - 8 contacts (8 position)  
6 - 6 contacts (6 position)  
4 - 4 contacts (4 or 6 position)

**OPTIONS**

1 - without flanged  
2 - flanged

**GOLD PLATING**

1 - 6  $\mu$  inches gold  
2 - 15  $\mu$  inches gold  
3 - 30  $\mu$  inches gold  
4 - 50  $\mu$  inches gold

## Single Port

### NON-SHIELDED

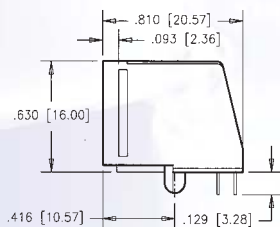
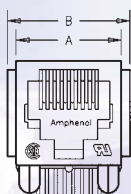

### PCB LAYOUT

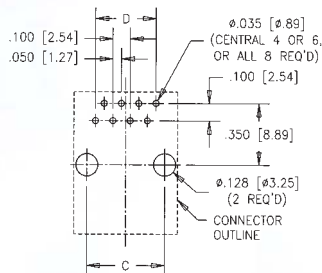

Number of positions	A	B	C	D
4	.440[11.18]	.540[13.72]	.300[7.62]	.150[3.81]
6	.520[13.21]	.620[15.75]	.400[10.16]	.250[6.35]
8	.600[15.24]	.700[17.78]	.450[11.43]	.350[8.89]

# RJA03 Series

LOW PROFILE - SINGLE PORT

## Material Specifications

### PHYSICAL

**Housing:** High Strength Thermoplastic Polyester Flammability Rating UL94V-0

**Contacts:** Phosphor Bronze

**Contact Plating:** Gold Over Nickel On Mating Area, Tin-Lead Alloy On Tails

**Shield:** Copper Alloy, Tin-Lead Alloy Plated

### ELECTRICAL

**UL File #:** E136228

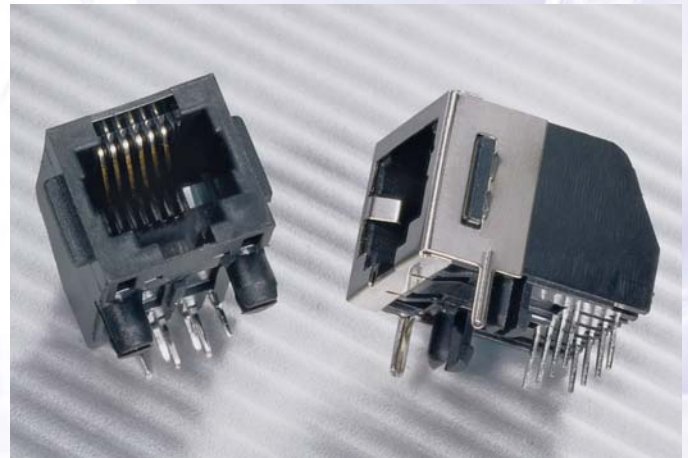

## Ordering Information

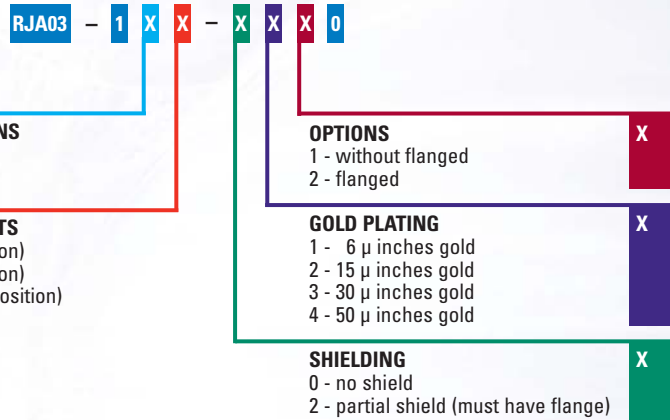

## Single Port (8 & 6 Position)

### NON-SHIELDED

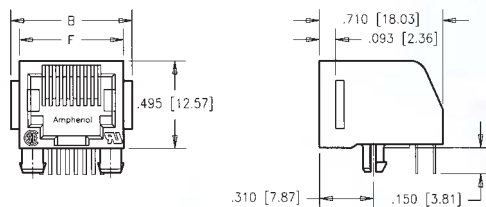

### PARTIAL SHIELD

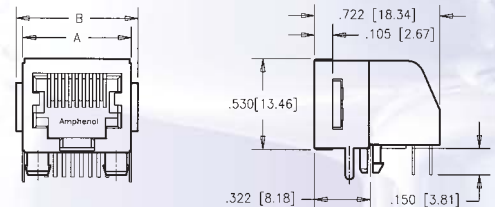

### PCB LAYOUT

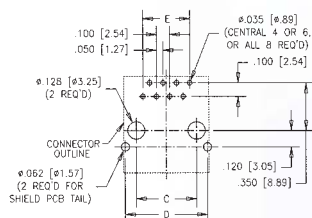

Number of positions	Number of contacts	A	B	C	D	E	F
6	4	.544 [13.83]	.620 [15.75]	.400 [10.16]	.533 [13.54]	.150 [3.81]	.520 [13.21]
6	6	.544 [13.21]	.620 [15.75]	.400 [10.16]	.533 [13.54]	.250 [6.35]	.520 [13.21]
8	8	.624 [15.24]	.700 [17.78]	.450 [11.43]	.613 [15.57]	.350 [8.89]	.600 [15.24]

# RJA05 Series

ULTRA LOW PROFILE - SINGLE PORT

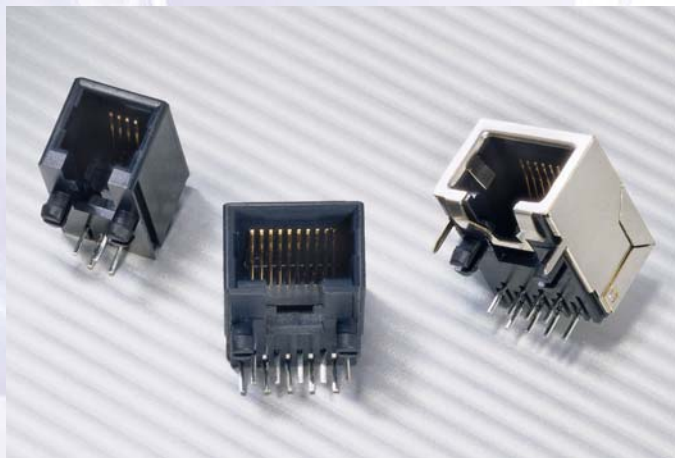

## Material Specifications

### PHYSICAL

**Housing:** High Strength Thermoplastic Polyester  
Flammability Rating UL94V-0

**Contacts:** Phosphor Bronze

**Contact Plating:** Gold Over Nickel On Mating Area, Tin-Lead Alloy On Tails

**Shield:** Copper Alloy, Tin-Lead Alloy Plated

### ELECTRICAL

**UL File # :** E136228

## Ordering Information

RJA05 - 1 X X - X X 1 0

X

#### NUMBER OF POSITIONS

A - 10 position  
8 - 8 position  
6 - 6 position  
4 - 4 position

X

#### NUMBER OF CONTACTS

A - 10 contacts (10 position)  
8 - 8 contacts (8 position)  
6 - 6 contacts (6 position)  
4 - 4 contacts (4 or 6 position)

#### GOLD PLATING

1 - 6  $\mu$  inches gold (0.15 microns)  
2 - 15  $\mu$  inches gold (0.38 microns)  
3 - 30  $\mu$  inches gold (0.76 microns)  
4 - 50  $\mu$  inches gold (1.27 microns)

#### SHIELDING

0 - no shield  
1 - full shield

## Single Port

### NON-SHIELDED

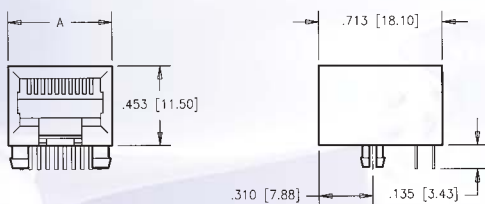

### PCB LAYOUT

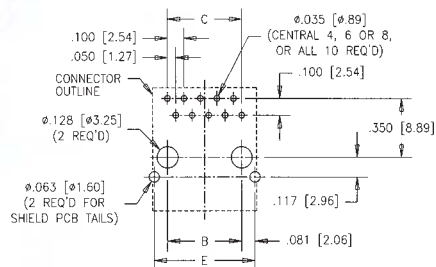

### SHIELDED

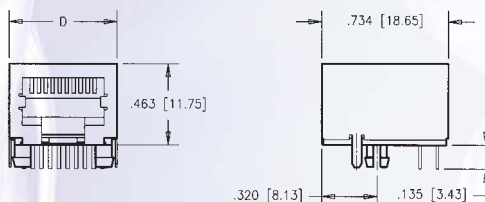

Number of positions	A	B	C	D	E
4	.440[11.18]	.300[7.62]	.150[3.81]		
6	.520[13.21]	.400[10.16]	.250[6.35]		
8	.600[15.24]	.450[11.43]	.350[8.89]	.620[15.74]	.612[15.54]
10	.600[15.24]	.450[11.43]	.450[11.43]	.620[15.74]	.612[15.54]

# RJA09 Series

FULLY SHIELDED - SINGLE & MULTI PORT

## Specifications

### MATERIAL

<b>Housing:</b>	High Strength Thermoplastic Polyester Flammability Rating UL94V-0
<b>Contacts:</b>	Phosphor Bronze
<b>Contact Plating:</b>	Gold Over Nickel On Mating Area, Tin-Lead Alloy On Tails
<b>Shield:</b>	Copper Alloy, Tin Plated

### ELECTRICAL

<b>UL File #:</b>	E136228
-------------------	---------

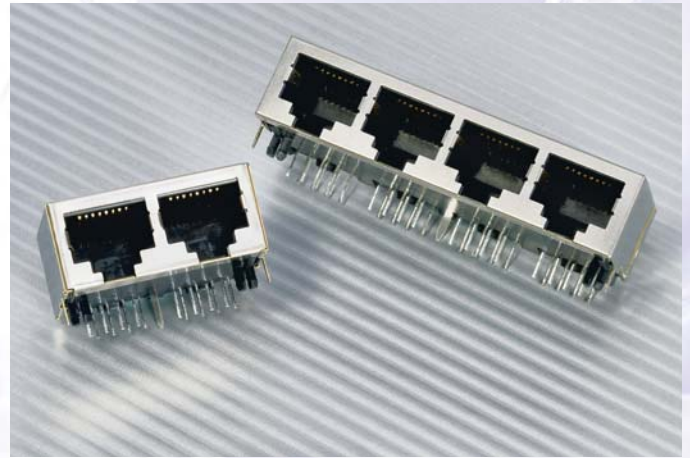

## Ordering Information

RJA09 - XXX - 1 X 1 0

<b>XXX</b>	<b>NUMBER OF POSITIONS</b>
	188 - 1 port, 8 position
	1AA - 1 port, 10 position
	288 - 2 port, 8 position
	488 - 4 port, 8 position
	688 - 6 port, 8 position
	888 - 8 port, 8 position
	A88 - 10 port, 8 position
	B88 - 12 port, 8 position

<b>GOLD PLATING</b>	<b>X</b>
	1 - 6 $\mu$ inches gold
	2 - 15 $\mu$ inches gold
	3 - 30 $\mu$ inches gold
	4 - 50 $\mu$ inches gold

## Single Port (8 & 10 position)

### NON-SHIELDED

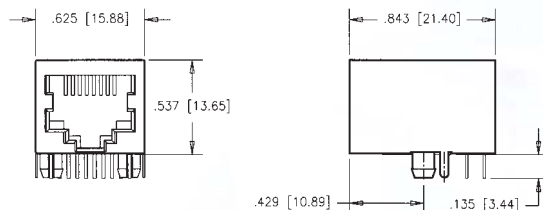

Number of positions	A
8	.350[8.89]
10	.450[11.43]

### PCB LAYOUT

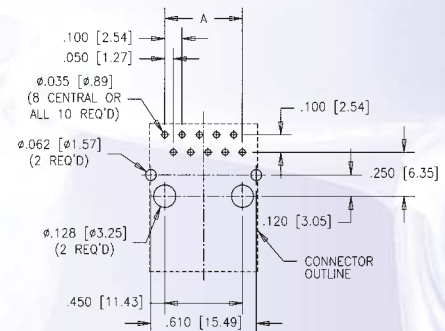

# RJA09 Series

FULLY SHIELDED - SINGLE & MULTI PORT

## Multiport (8 position)

### NON-SHIELDED

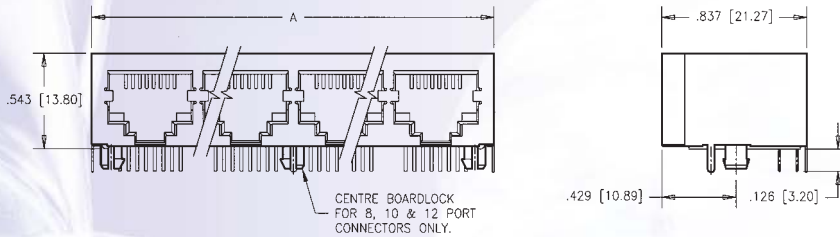

### PCB LAYOUT

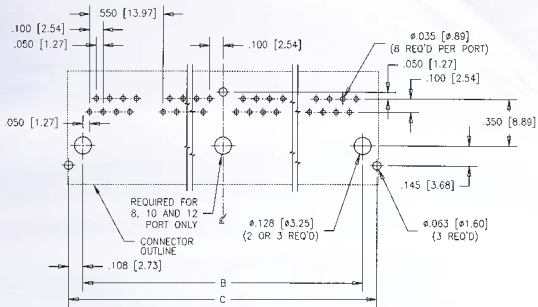

Number of ports	A	B	C
2	1.225[31.12]	1.000[25.40]	1.215[30.87]
4	2.324[59.03]	2.100[53.34]	2.315[58.81]
6	3.425[87.00]	3.200[81.28]	3.415[86.75]
8	4.525[114.94]	4.300[109.22]	4.515[114.69]
10	5.625[142.88]	5.400[137.16]	5.615[142.63]
12	6.725[170.82]	6.500[165.10]	6.715[170.57]

# RJA06 Series

TOP ENTRY - SLIM PROFILE

## Specifications

### MATERIAL

<b>Housing:</b>	High Strength Thermoplastic Polyester Flammability Rating UL94V-0
<b>Contacts:</b>	Phosphor Bronze
<b>Contact Plating:</b>	Gold Over Nickel On Mating Area, Tin-Lead Alloy On Tails
<b>Shield:</b>	Copper Alloy, Tin-Lead Alloy Plated

### ELECTRICAL

<b>UL File #:</b>	E136228
-------------------	---------

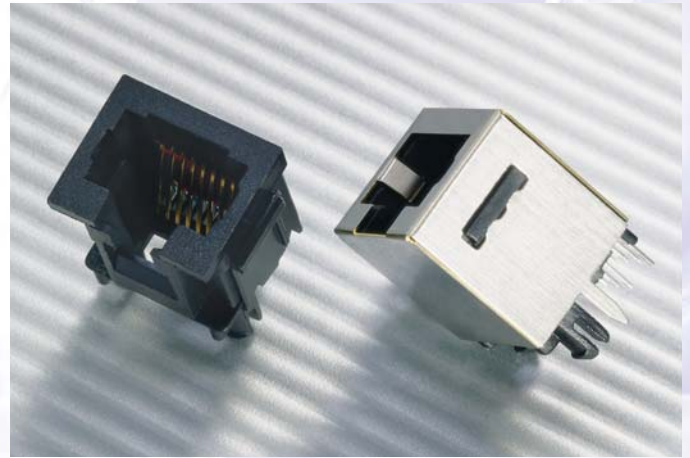

## Ordering Information

RJA06 - 188 - X X X 0

<b>X</b>	<b>SHIELDING OPTION</b> 0 - no shield 1 - full shield
----------	---

<b>OPTIONS</b> 1 - without flanged 2 - flanged	<b>X</b>
--	----------

<b>GOLD PLATING</b> 1 - 6 $\mu$ inches gold (0.15 microns) 2 - 15 $\mu$ inches gold (0.38 microns) 3 - 30 $\mu$ inches gold (0.76 microns) 4 - 50 $\mu$ inches gold (1.27 microns)	<b>X</b>
--	----------

## Single Port

### NON-SHIELDED

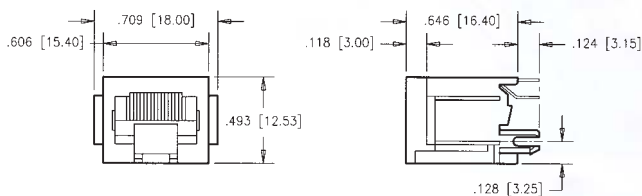

### PCB LAYOUT

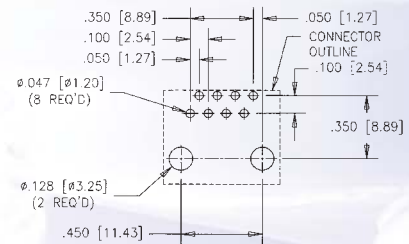

### SHIELDED

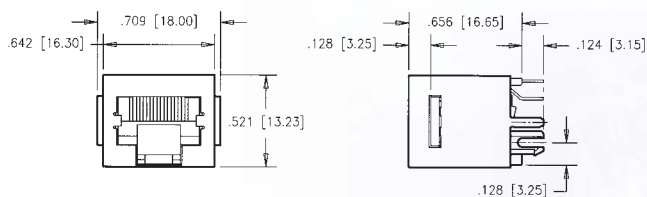

### PCB LAYOUT

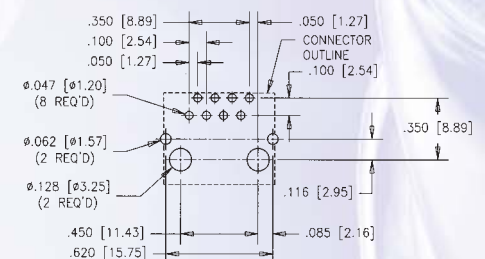

# RJA08 Series

TOP ENTRY

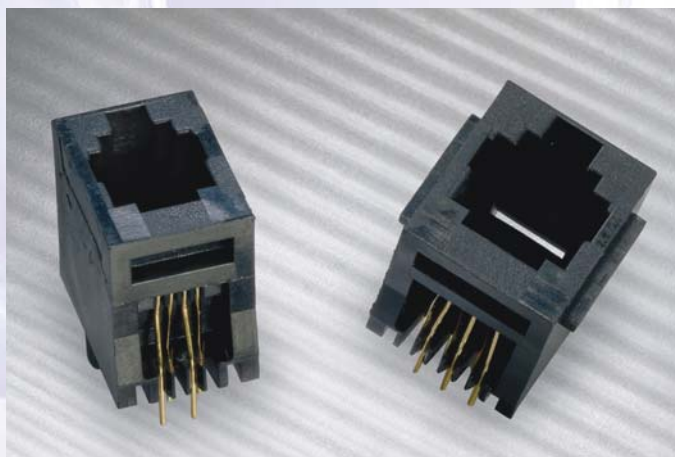

## Specifications

### MATERIAL

**Housing:** High Strength Thermoplastic Polyester Flammability Rating UL94V-0

**Contacts:** Phosphor Bronze

**Contact Plating:** Gold Over Nickel On Mating Area, Tin-Lead Alloy On Tails

### ELECTRICAL

**UL File # :** E136228

## Ordering Information

RJA08 - 1 X X - 0 X X 0

#### X NUMBER OF POSITIONS

A - 10 position  
8 - 8 position  
6 - 6 position  
4 - 4 position

#### X NUMBER OF CONTACTS

A - 10 contacts (10 position)  
8 - 8 contacts (8 position)  
6 - 6 contacts (6 position)  
4 - 4 contacts (4 or 6 position)

#### OPTIONS

1 - without flange  
2 - flanged

#### X GOLD PLATING

1 - 6  $\mu$  inches gold (0.15 microns)  
2 - 15  $\mu$  inches gold (0.38 microns)  
3 - 30  $\mu$  inches gold (0.76 microns)  
4 - 50  $\mu$  inches gold (1.27 microns)

## NON-SHIELDED

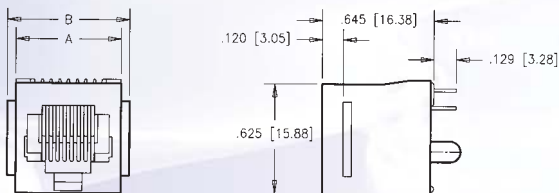

Number of positions	A	B	C	D
4	.450 [11.43]	.550 [13.97]	.300 [7.62]	.150 [3.81]
6	.530 [13.46]	.630 [16.00]	.400 [10.16]	.250 [6.35]
8	.605 [15.36]	.702 [17.84]	.465 [11.80]	.350 [8.89]

## PCB LAYOUT

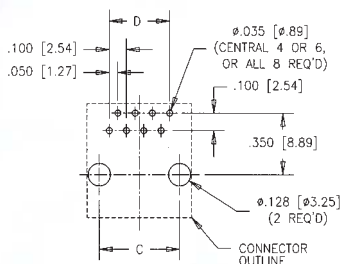



# RJA07 Series

SURFACE MOUNT - SINGLE PORT

## Specifications

### MATERIAL

**Housing:** High Temperature Resistant Nylon  
Flammability Rating UL94V-0

**Contacts:** Phosphor Bronze

**Contact Plating:** Gold Over Nickel On Mating Area, Tin-Lead Alloy On Tails

**Shield:** Copper Alloy, Tin-Lead Alloy Plated

### ELECTRICAL

**UL File #:** E136228



## Ordering Information

RJA07 - 1 X X - X X X 0

**X** **NUMBER OF POSITIONS**  
8 - 8 position  
6 - 6 position

**X** **NUMBER OF CONTACTS**  
8 - 8 contacts (8 position)  
6 - 6 contacts (6 position)  
4 - 4 contacts (6 position)

**OPTIONS**

1 - without flanged

2 - flanged (must be flanged for 'shield' option)

**GOLD PLATING**

1 - 6  $\mu$  inches gold (0.15 microns)  
2 - 15  $\mu$  inches gold (0.38 microns)  
3 - 30  $\mu$  inches gold (0.76 microns)  
4 - 50  $\mu$  inches gold (1.27 microns)

**SHIELDING**

0 - no shield  
2 - through hole shield  
3 - surface mount shield

### NON-SHIELDED

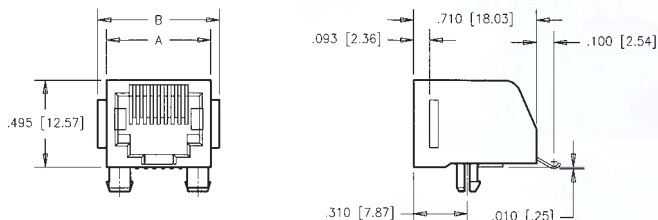

### PCB LAYOUT

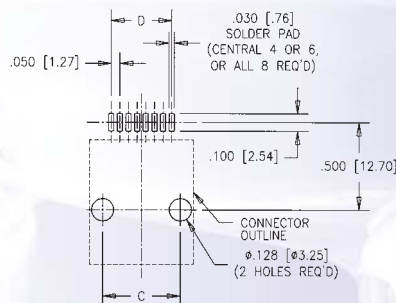

Number of positions	Number of contacts	A	B	C	D
6	4	.520 [13.21]	.620 [15.75]	.400 [10.16]	.150 [3.81]
6	6	.520 [13.21]	.620 [15.75]	.400 [10.16]	.250 [6.35]
8	8	.600 [15.24]	.700 [17.78]	.450 [11.43]	.350 [8.89]

# RJA07 Series

SURFACE MOUNT - SINGLE PORT

## Through Hole Shield

### PARTIALY SHIELDED

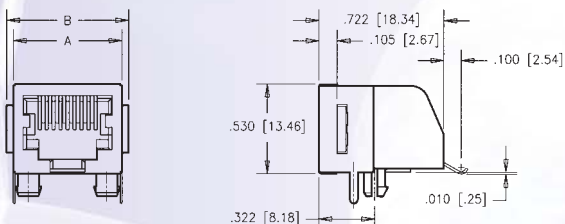

### PCB LAYOUT

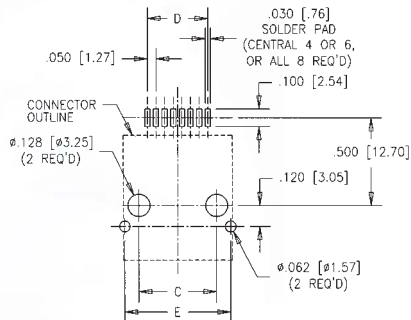

Number of positions	Number of contacts	A	B	C	D	E
6	4	.544 [13.83]	.620 [15.75]	.400 [10.16]	.150 [3.81]	.533 [13.54]
6	6	.544 [13.21]	.620 [15.75]	.400 [10.16]	.250 [6.35]	.533 [13.54]
8	8	.624 [15.24]	.700 [17.78]	.450 [11.43]	.350 [8.89]	.613 [15.57]

## Surface Mount Shield

### PARTIALY SHIELDED

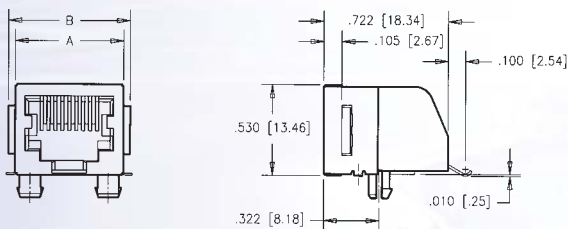

### PCB LAYOUT

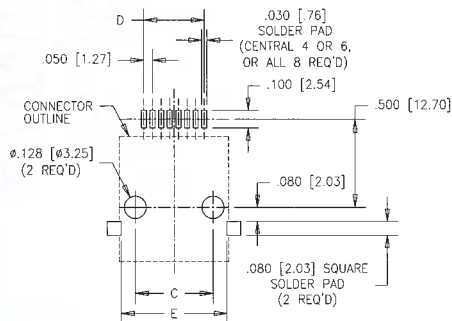

Number of positions	Number of contacts	A	B	C	D	E
6	4	.544 [13.83]	.620 [15.75]	.400 [10.16]	.150 [3.81]	.533 [13.54]
6	6	.544 [13.21]	.620 [15.75]	.400 [10.16]	.250 [6.35]	.533 [13.54]
8	8	.624 [15.24]	.700 [17.78]	.450 [11.43]	.350 [8.89]	.613 [15.57]

# RJA15 Series

ULTRA LOW PROFILE - SMT SINGLE PORT

## Specifications

### MATERIAL

**Housing:** High Temperature Resistant Nylon  
Flammability Rating UL94V-0

**Contacts:** Phosphor Bronze

**Contact Plating:** Gold Over Nickel On Mating Area, Tin-Lead Alloy On Tails

**Shield:** Copper Alloy, Tin-Lead Alloy Plated

### ELECTRICAL

**UL File #:** E136228



## Ordering Information

RJA15 - 1 X X - X X 1 0

**X NUMBER OF POSITIONS**

A - 10 position  
8 - 8 position  
6 - 6 position  
4 - 4 position

**X NUMBER OF CONTACTS**

A - 10 contacts (10 position)  
8 - 8 contacts (8 position)  
6 - 6 contacts (6 position)  
4 - 4 contacts (4 or 6 position)

**GOLD PLATING**

1 - 6  $\mu$  inches gold (0.15 microns)  
2 - 15  $\mu$  inches gold (0.38 microns)  
3 - 30  $\mu$  inches gold (0.76 microns)  
4 - 50  $\mu$  inches gold (1.27 microns)

**SHIELDING OPTION**

0 - non-shielded  
1 - shielded

### NON-SHIELDED

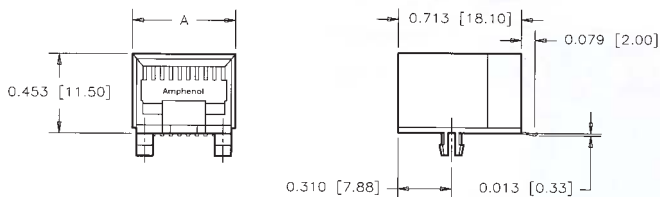

### SHIELDED

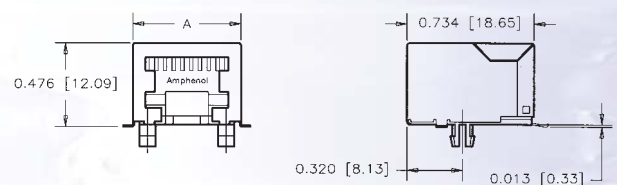

### PCB LAYOUT

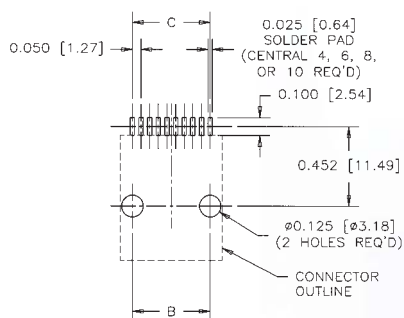

Number of positions	Unshielded	Shielded		
	A	A	B	C
4	.441 [11.21]	.469 [11.92]	.300 [7.62]	.150 [3.81]
6	.510 [12.96]	.538 [13.67]	.400 [10.16]	.250 [6.35]
8	.592 [15.03]	.620 [15.74]	.450 [11.43]	.350 [8.89]
10	.592 [15.03]	.620 [15.74]	.450 [11.43]	.450 [11.43]

# RJLSE Series

ULTRA LOW PROFILE - SMT SERIES

## Material Specifications

- Housing:** High temperature engineering thermoplastic, flammability rating UL 94V-0  
\*RoHS compliant
- Contacts:** Phosphor bronze  
**Plating:** Gold plated on mating surfaces over 50µ" (1.27 microns) min. nickel underplate. 100µ" (2.54 microns) min. matte tin on contact tails.
- Shield:** Copper alloy, nickel plated
- Coplanarity:** The maximum gap between all terminal tails is .004" (0.10mm).

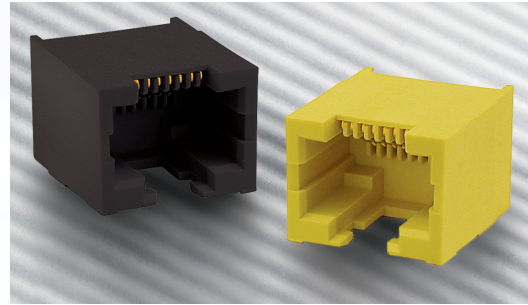

\*Please visit [www.amphenolcanada.com](http://www.amphenolcanada.com) (ECO-RoHS section) for further information on RoHS products.

## Ordering Information

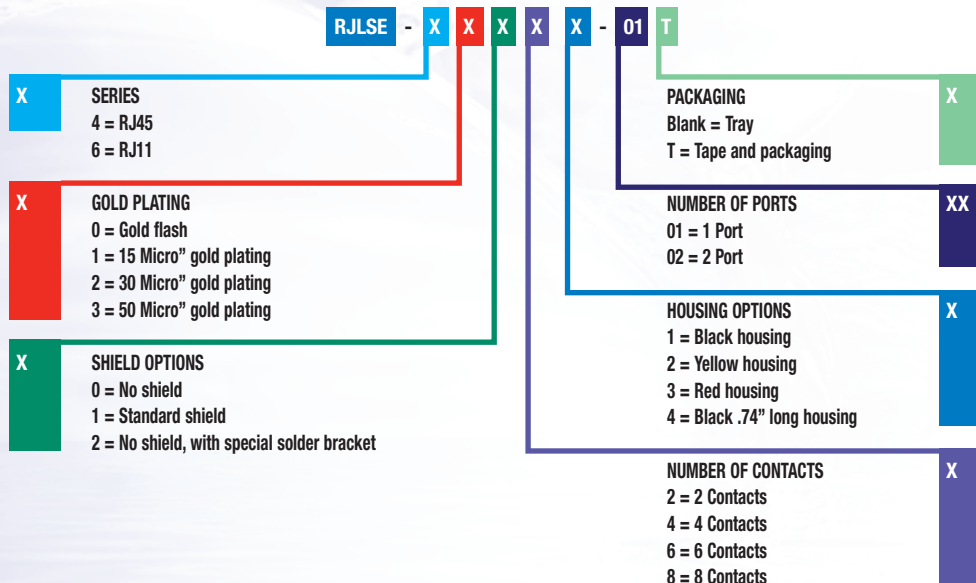

### NON - SHIELDED

### SHIELDED

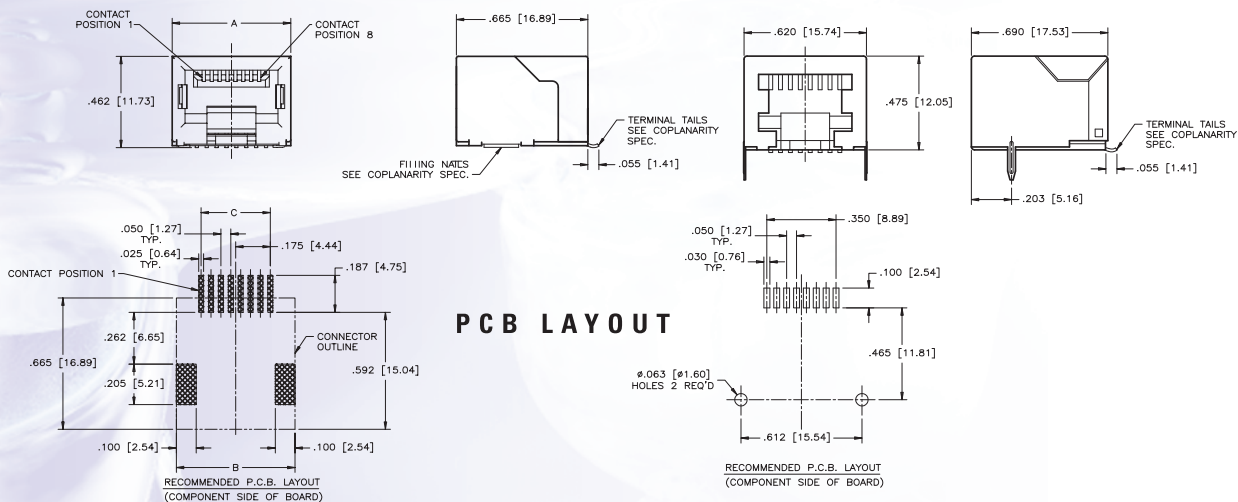

Number of positions	Unshielded		Shielded		C	D
	A	B	A	B		
6	.520 [13.21]	.532 [13.51]	.540 [13.71]	.532 [13.51]	.520 [13.21]	.250 [6.35]
8	.600 [15.24]	.612 [15.64]	.620 [15.74]	.612 [15.64]	.600 [15.24]	.350 [8.89]

