

MODULAR JACKS



Amphenol[®]
www.rjvista.com

Contents

Amphenol Data/Telecom Products Group of Amphenol Canada Corp., a subsidiary of Amphenol Corporation, is an ISO 9001 certified facility located in Toronto, Canada. Our activities are dedicated to the design, development and manufacture of interconnect products intended for use in the data communications and telecommunications markets. Our expertise in understanding and supporting our customers' interconnect needs has earned Amphenol Canada a

reputation of quality and excellence among the world's leading users of electronic components.

This Modular Jack catalog represents some of our more popular products within this product category. Other product categories include, but are not limited to: D-Sub, Micro-Ribbon, USB, RF, Fiber-Optic, DIN 41612, mini-DIN, Headers and Sockets, Firewire, SCSI, VHDCI and Filtered Connector products.

RJ Vista

EMI Quiet with LEDs

Single Port

Multi Port

RJSS

Stacked

RJHS	1-2
RJHS	3-4
RJHS	5-6
RJSS	7-8
RJSA	9-10

Filtered & Shielded

Single Port

Multi Port

FRJ/FRJA	11-12
FRJA	13

EMI Quiet

6 Position

RJ01	14-15
-------------	--------------

Right Angle

Single Port High Profile

Single Port Low Profile

Single Port Ultra Low Profile

Multi Port Full Shield

RJA02	16
RJA03	17
RJA05	18
RJA09	19-20

Top Entry

Single Port Slim Profile

Single Port Standard Profile

RJA06	21
RJA08	22

Surface Mount

Single Port

Single Port Low Profile

RJA07	23-24
RJA15	25

NOTICE: Specifications are subject to change without notice. Contact your nearest Amphenol sales office for the latest specifications. All statements, information and data given herein are believed to be accurate and reliable, but are presented without guarantee, warranty, or responsibility of any kind, expressed or implied. Statements or suggestions

concerning possible use of our products are made without representation or warranty that any such use is free of patent infringement, and are not recommended to infringe any patent. The user should not assume that all safety measures are indicated or that other measures may not be required. Amphenol and RJ vista are registered trademarks.

RJHS Series

RJvista™

EMI QUIET - WITH LEDS

EMI Quiet Modular Jacks with LED's

RJvista™

is a family of EMI Quiet Modular Jack Connectors with built-in LEDs, meets Ethernet CAT 5 performance. This product is ideal for LAN applications such as adapter cards and routers. Shielded and non-shielded versions are available, with a variety of LED colors, and ports.



Specifications

MATERIAL

Shield: Copper Alloy; Tin/Lead Plated
Contacts: Phosphor Bronze; Gold over Nickel
Insert: Solder reflow process compatible (Complies with UL 94V-0)

ELECTRICAL

Contact Resistance: 20 milliohms maximum
Insulation Resistance: 500 megohms minimum
Current Rating: 1.5 Amps
Voltage Rating: 125 Volts AC
Dielectric Withstanding Voltage: 1000 VAC, RMS. 60 Hz. 1 min.

Standard LEDs: For 5.0 V Systems

Forward Voltage: 2.1 Volts Typical
Reverse Voltage: 6.0 Volts minimum
Luminous Intensity: 0.5 mCd minimum (at If=2mA)

Low Current LEDs: For 3.3 V Systems

Forward Voltage: 2.0 Volts Typical
Reverse Voltage: 6.0 Volts minimum
Luminous Intensity: 1.0 mCd minimum (at If=2mA)

Other Parameters:

Storage Temperature: -20° C to 85° C
Lead Soldering Temperature: 260° C (5 sec)
Plating on Tails: Tin-Lead (90-10) alloy

UL File # : E135615
CSA File # : LR68598

Ordering Information

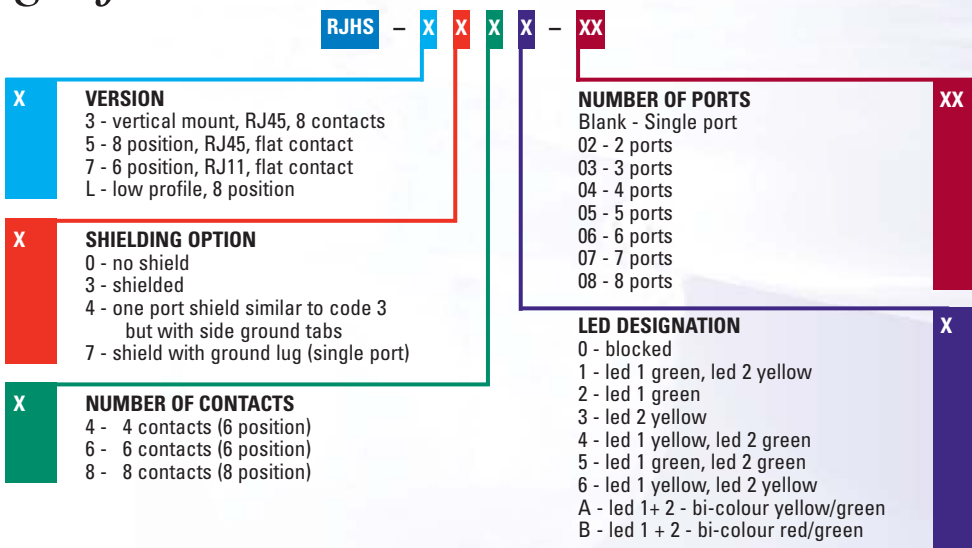

Options for style, shield & contacts available.
 Contact Amphenol Canada for more information

For additional colour combinations refer to Chart RJHS Page 2

RJHS Series

RJ
v_{ista}

EMI QUIET - WITH LEDS

LED Designation

RJHS - 538 1* - 08

* LED DESIGNATION CODE

LED CODE	LED 2 Left	LED 1 Right
0	Blocked	Blocked
1	Yellow	Green
2	Blocked	Green
3	Yellow	Blocked
4	Green	Yellow
5	Green	Green
6	Yellow	Yellow
7	Red	Green
8	Green	Red
9	Green	Blocked
A	BiC Gr/YI	BiC Gr/YI
B	BiC Rd/Gr	BiC Rd/Gr
C	BiC Rd/Gr	BiC Gr/YI
D	Green	BiC Gr/YI
E	Yellow	BiC Gr/YI
F	BiC Gr/YI	Yellow
G	BiC Gr/Or	BiC Gr/Or
H	BiC Gr/YI	Green
J	BiC Rd/Gr	Yellow
K	Yellow	BiC Gr/Or
L	BiC Rd/Gr	Red
M	Red	Yellow
N	BiC Gr/Rd	BiC Gr/YI
P	Green	BiC Rd/Gr
R	BiC Gr/Or	Green
T	Red	Red
V	BiC Rd/Gr	Green
W	Special Designation (add digit to part number)	
Z		

RJHS - 538W - 08 2*

* SPECIAL LED DESIGNATION

SPECIAL DESIGNATION	LED 2 Left	LED 1 Right
0	See standard Design	
1	Red	Blocked
2	BiC Gr/YI	Yellow
3	Yellow	Red
4	Blocked	Red
5	Blocked	Yellow
6	Red	BiC Gr/YI
7		
8		
9		

LOW CURRENT LED OPTIONS

A	Yellow	Yellow
B	Yellow	Green
C	Green	Yellow
D	Green	Green

LED 2

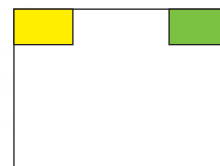

LED 1

* Contact Amphenol Canada for more information

Single Port

NON-SHIELDED

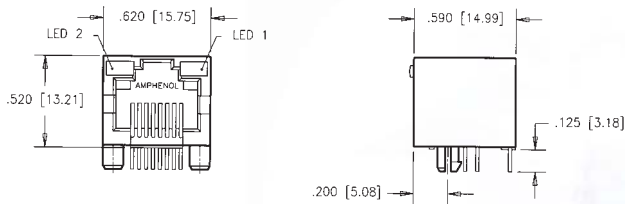

PCB LAYOUT

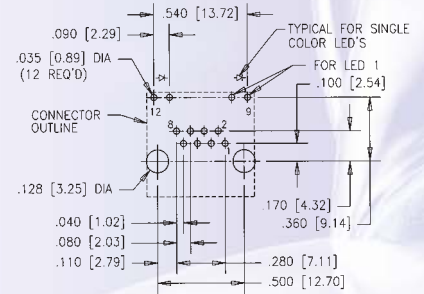

BI-COLOUR LEDS

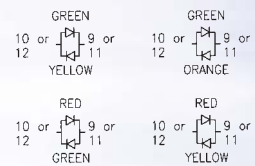

SHIELDED WITH TOP & SIDE GROUND TABS

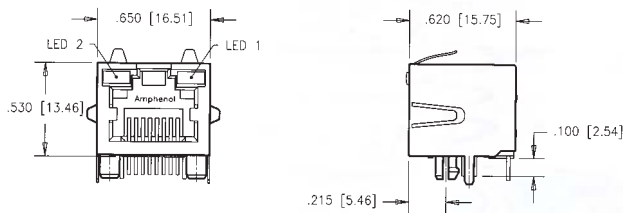

PCB LAYOUT

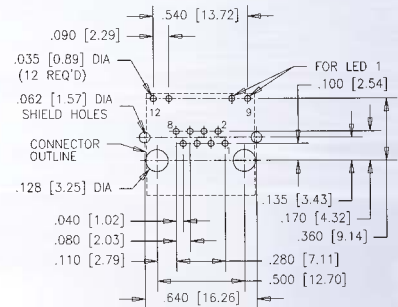

SHIELDED WITH GROUND LUG

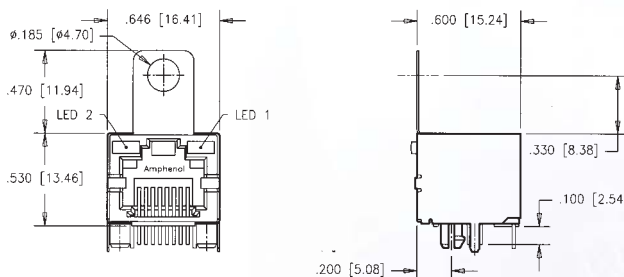

PCB LAYOUT

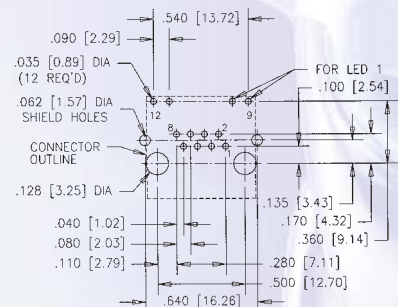

RJHS Series

RJvista™

EMI QUIET - WITH LEDS

VERTICAL MOUNT SINGLE PORT ONLY

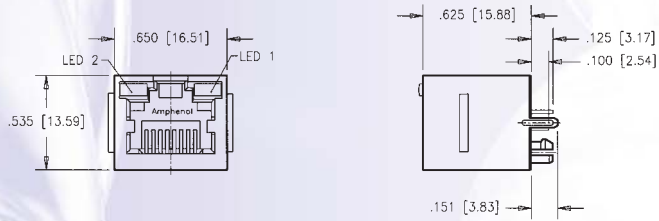

PCB LAYOUT

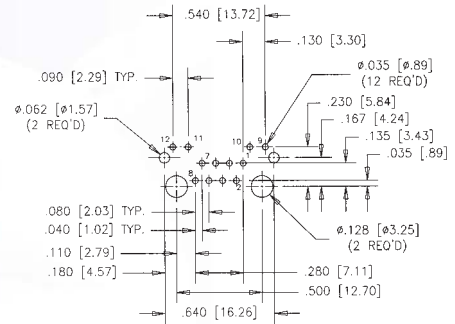

LOW PROFILE SINGLE & 2 PORT

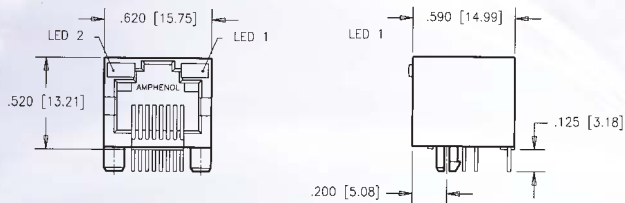

PCB LAYOUT

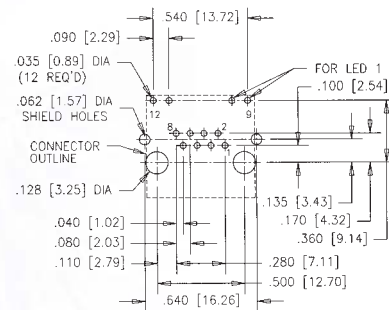

SHORTING BARS SINGLE & 2 PORT

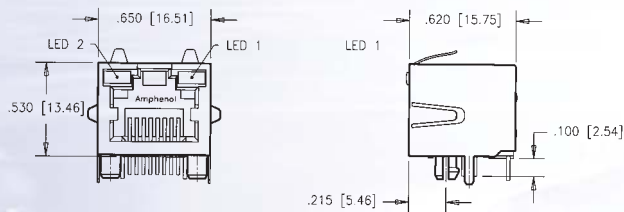

PCB LAYOUT

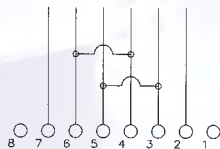
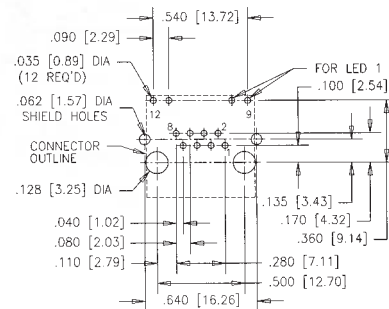

SHORTING BARS (CIRCUIT)

EMI Quiet Modular Jacks with LED's Multiport

RJ vista™ is a family of EMI Quiet Modular Jack Connectors with built-in LEDs, designed for Category 5 ethernet performance. This product is ideal for LAN applications such as adapter cards and routers. Shielded and non-shielded versions are available, with a variety of LED colors, and ports.



SHIELDED 2 PORT

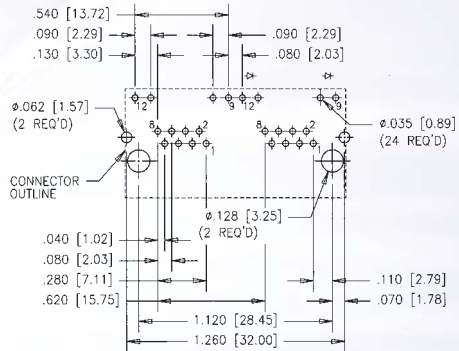
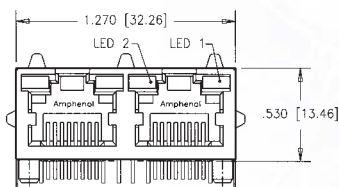

SHIELDED 3 PORT

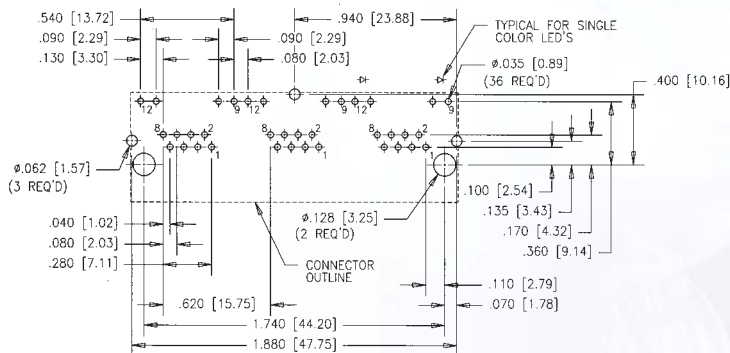
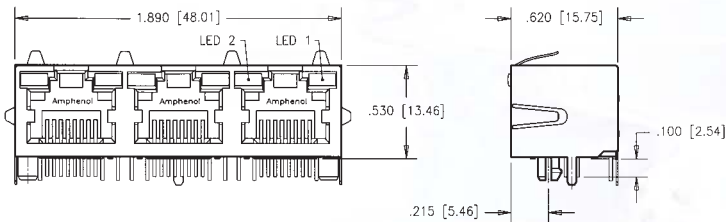

RJHS Series

RJvista™

EMI QUIET - WITH LEDS

SHIELDED WITH TOP AND SIDE GROUND TABS (AVAILABLE IN MULTI-PORT)

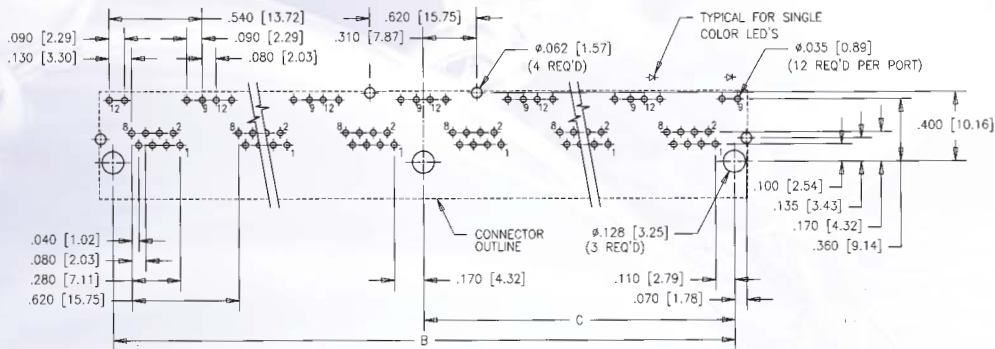
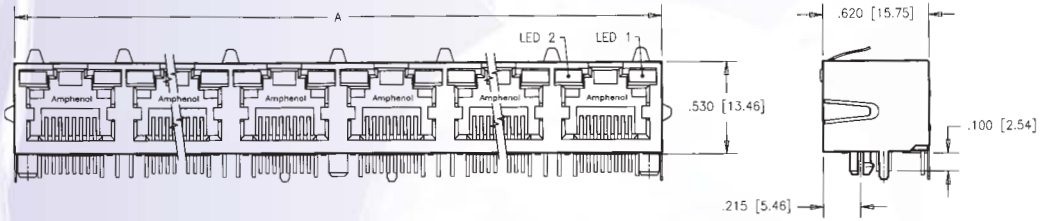

Number of ports	A	B	C
2	see page 5	see page 5	see page 5
3	see page 5	see page 5	see page 5
4	2.510[63.75]	2.360[59.94]	1.180[29.97]
6	3.750[95.25]	3.600[91.44]	1.800[45.72]
8	4.990[126.75]	4.840[122.94]	2.420[61.47]

RJSS: SMT Connector with Light Pipes

Amphenol Canada's RJSS series represents an expansion of our current RJHS series connector. The RJSS offers all the benefits of the RJHS series in SMT. This connector meets Cat 5 Ethernet Performance.

Shielded and unshielded versions are available with or without light pipe option.



Specifications

MATERIAL

Shield:	Copper Alloy; Tin/Lead Plated
Contacts:	Phosphor Bronze; Gold Plated over Nickel on mating area, Tin lead on the terminals
Insert:	Phosphor Bronze; Gold over Nickel (Complies with UL 94V-0)

ELECTRICAL

Contact Resistance:	20 milliohms maximum
Insulation Resistance:	500 megohms minimum
Current Rating:	1.5 Amps
Voltage Rating:	125 Volts AC
Dielectric Withstanding Voltage:	1500 VAC, RMS. 60 Hz. 1 min.
Other Parameters:	
Storage Temperature:	-20°C to +85°C
Plating on Tails:	Tin/Lead (90-10) Alloy

Ordering Information

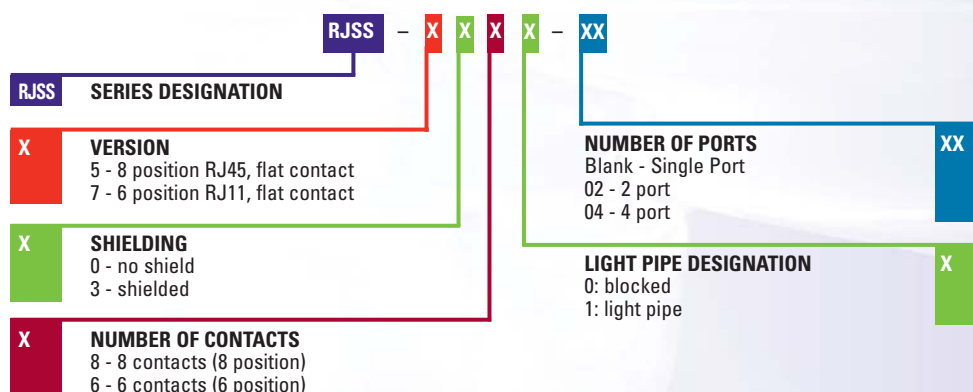

RJSS Series

SMT CONNECTOR

Single Port

RJSS - 5381

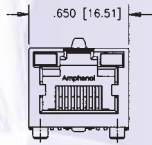

SHIELD WITH TOP GROUND TAB
LIGHT PIPE OPTIONAL

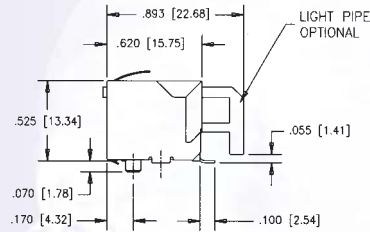

PCB LAYOUT

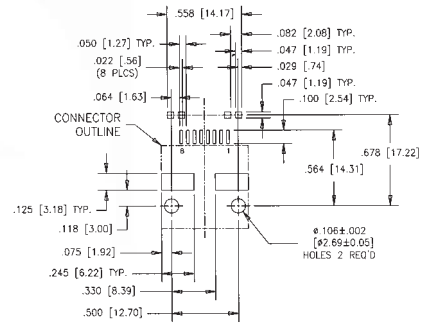

2 Port

RJSS - 5381 - 02

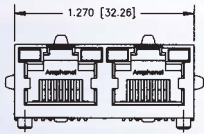

SHIELD WITH TOP AND SIDE GROUND TAB
LIGHT PIPE OPTIONAL

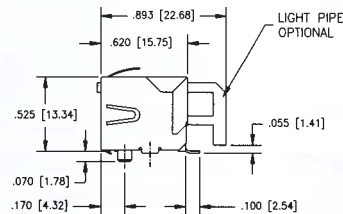

PCB LAYOUT

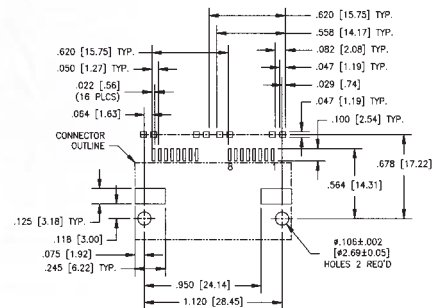

4 Port

RJSS - 5381 - 04

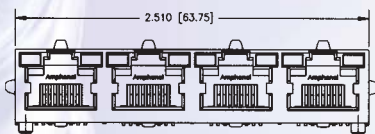

SHIELD WITH TOP AND SIDE GROUND TAB
LIGHT PIPE OPTIONAL

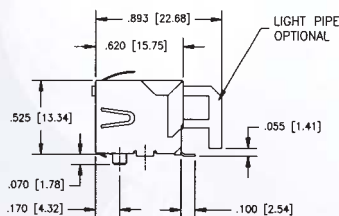

PCB LAYOUT

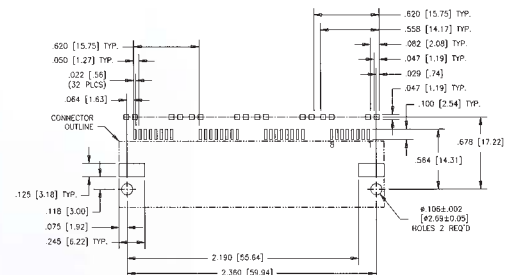

Amphenol RJ45 Stackable

Reduces component and labour costs by incorporating LED's into the connector.

Meets Ethernet CAT 5 Performance

Stackable feature enables more ports with same board space.

For superior EMI performance, the option of configuring your connector with a ferrite filter is available.

Amphenol offers a wide variety of options:

- Ferrite filter
- Shielded & unshielded versions
- Variety of LED combinations
- Variety of ports



Specifications

MATERIAL

Please refer to RJHS specifications on page 1.

ELECTRICAL

UL File #: E135615

CSA File #: 150190

Impedance Characteristics

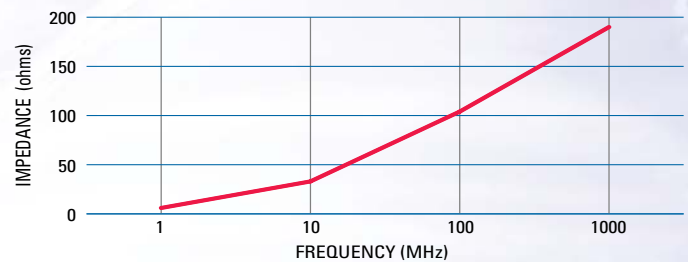

Ordering Information

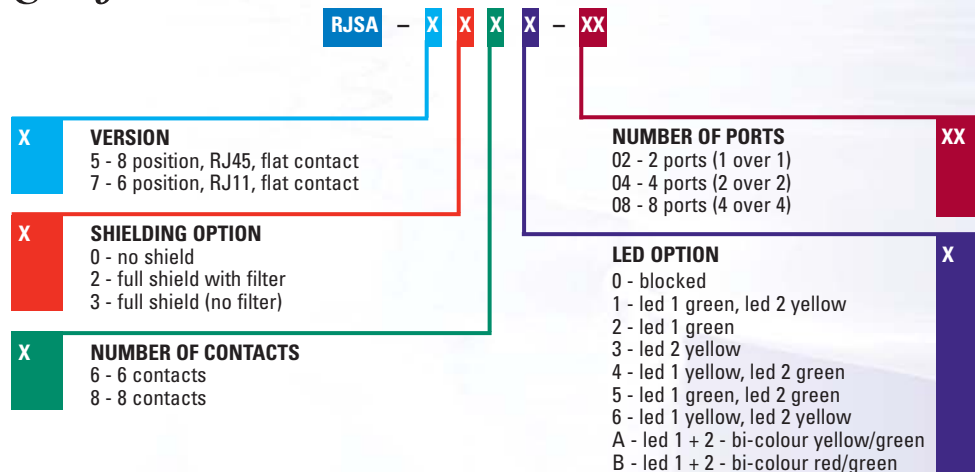

* Filtering available - Please contact Amphenol for more information
** additional LED codes available - see page 2

RJSA Series

STACKED RJ VISTA™

2 x 1 RJ45/RJ11

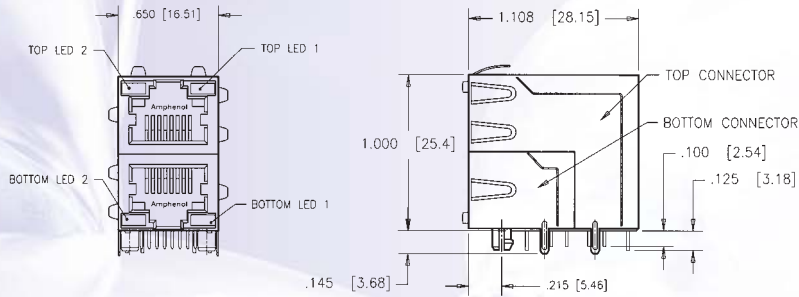

PCB LAYOUT

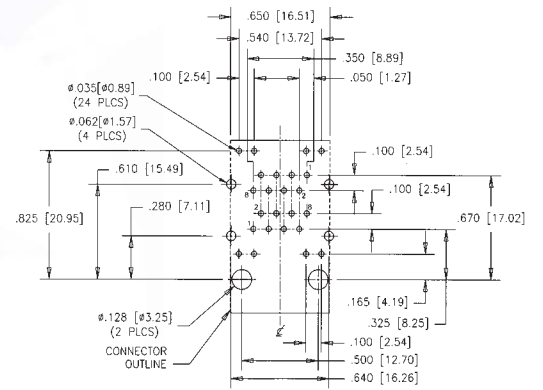

2 X 4 RJ45/RJ11

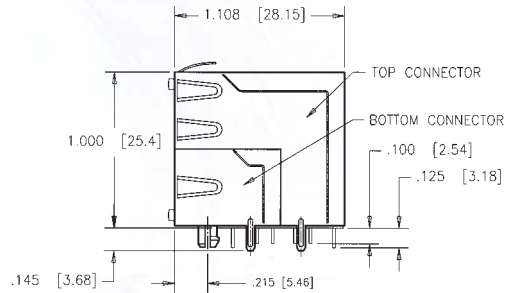
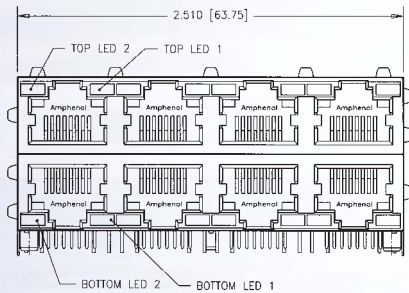

PCB LAYOUT

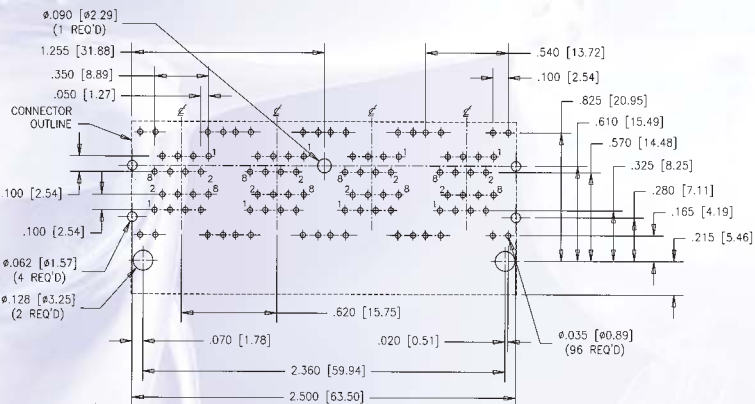

ASSEMBLY

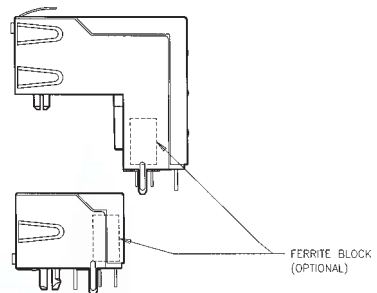

STACKABLE MODULAR JACK ASSEMBLY

FRJ/FRJA Series

FILTERED & SHIELDED

Modular Jack with Superior EMI Performance

The FRJ and FRJA series of shielded and filtered modular jacks offer low cost and effective EMC control within standard RJ-11 and RJ-45 connector footprints. EMC control is offered by a completely shielded connector and/or with the use of a high resistivity, high impedance ferrite block. No board layout changes are required for its use. Simply replace the standard non-filtered connector for superior EMC performance.

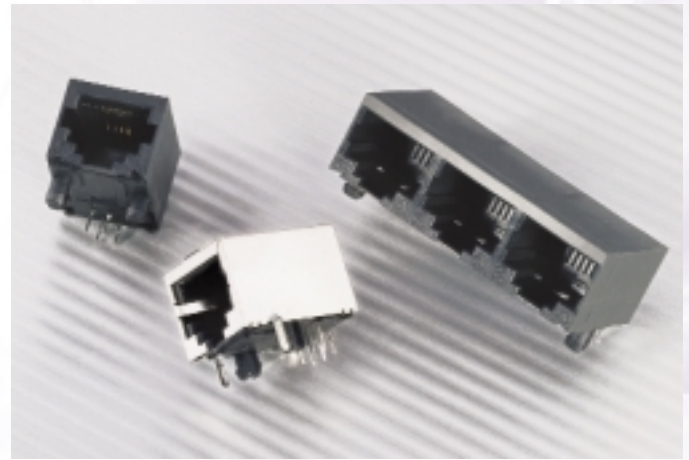

Specifications

MATERIAL

Shield:	Copper Alloy; Tin/Lead Plated
Contacts:	Phosphor Bronze; Gold over 30μ inches (0.76 microns) over Ni
Insert:	For FRJ, High Temperature Resistant Nylon. For FRJA, Thermoplastic Polyester (Complies with UL 94V-0)
Filter:	High Impedance, High Resistivity, Ferrite Block

ELECTRICAL

Contact Resistance:	20 Milliohms maximum
Insulation Resistance:	500 Megaohms minimum
Current Rating:	1.5 Amps
Voltage Rating:	125 Volts AC
UL File # :	E135615
CSA File #:	LR68598

Impedance Characteristics

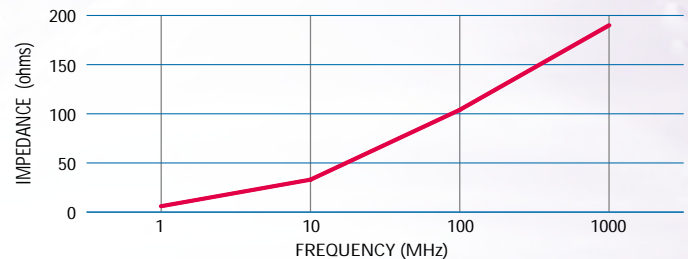

6 Position Filtered - High Profile

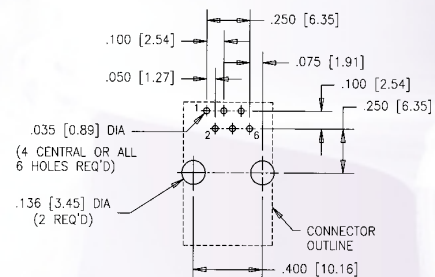
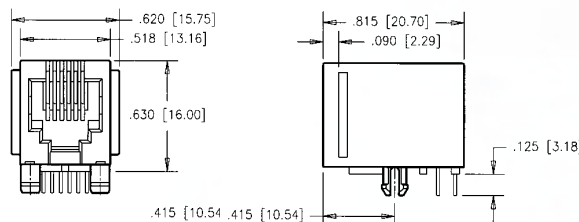

4 Contacts:

Standard Jack:	FRJ-104
Filtered:	FRJ-144

6 Contacts:

Standard Jack:	FRJ-106
Filtered:	FRJ-146

FRJA Series

FILTERED & SHIELDED

Ordering Information

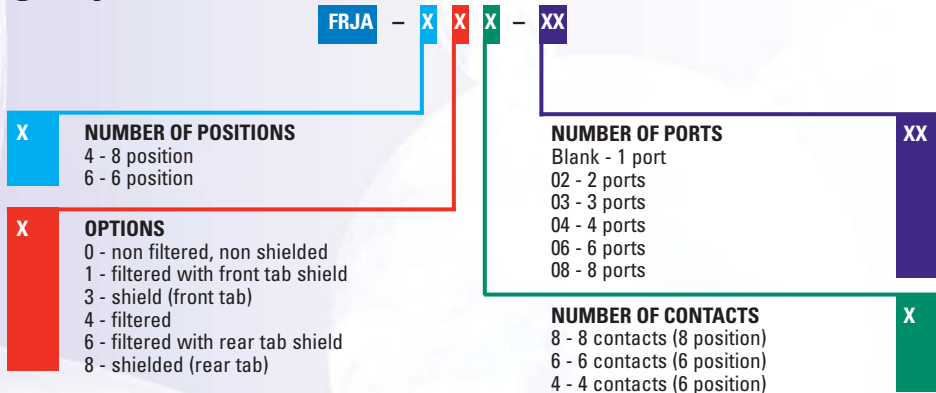

PCB LAYOUT

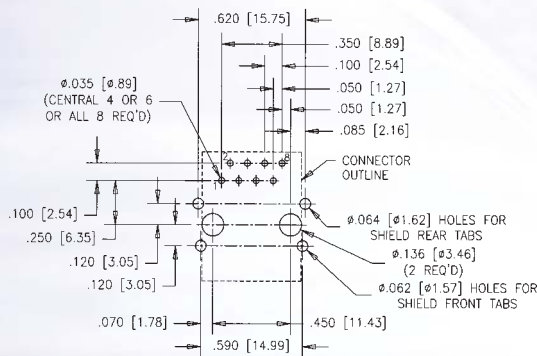

Single Port (8 & 6 position)

NON-SHIELDED

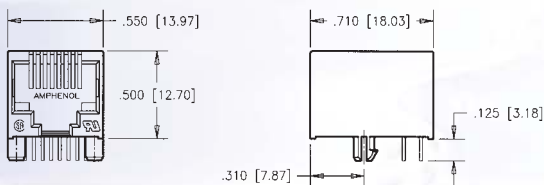

SHIELDED

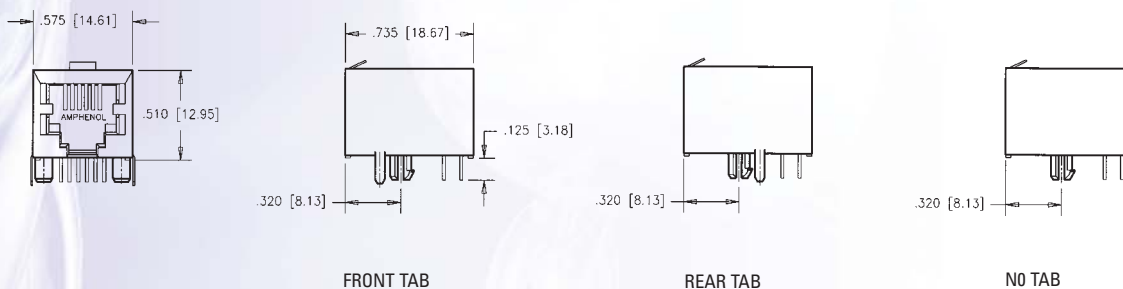

Multi Port (8 & 6 position)

NON-SHIELDED

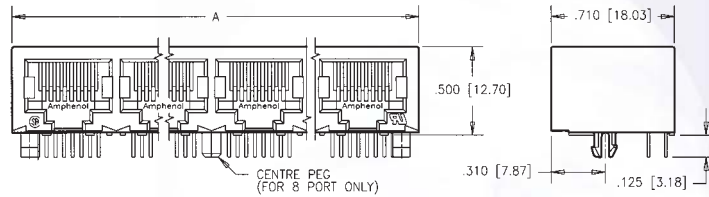

SHIELDED

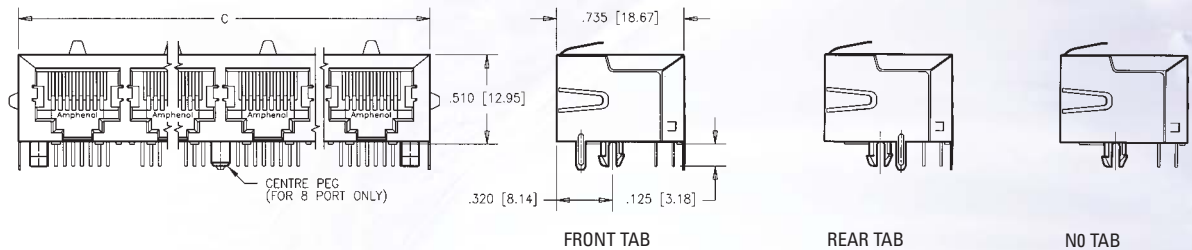

PCB LAYOUT

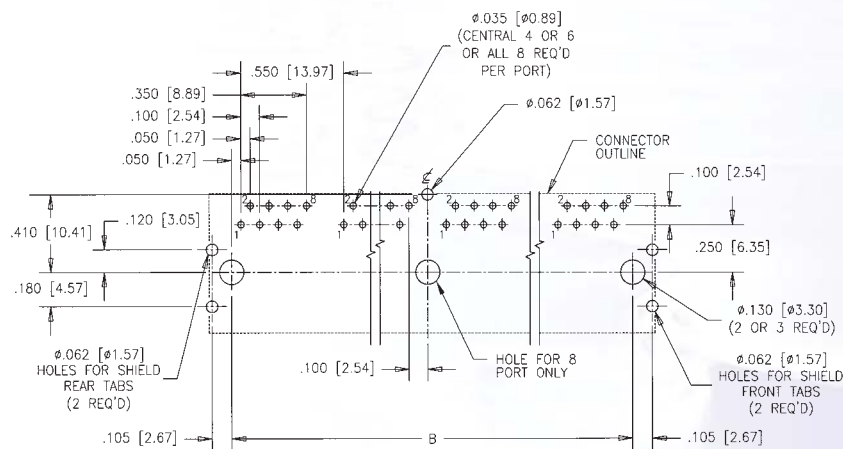

Number of ports	A	B	C
2	1.200[30.48]	1.000[25.40]	1.230[31.24]
4	2.300[58.42]	2.100[53.34]	2.330[59.18]
6	3.400[86.36]	3.200[81.28]	3.430[87.12]
8	4.500[114.30]	4.300[109.22]	4.530[115.06]

RJ01 Series

EMI QUIET - 6 POSITION

MODEM CONNECTORS

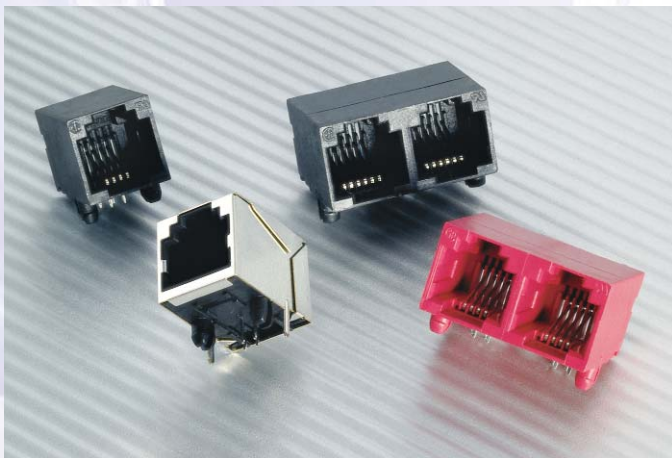

Modular Jack with Superior EMI Performance

The RJ01 series of 6-position jacks are designed for superior EMI performance. The inverted connector provides shorter leads, eliminating the EMI antenna effect of the standard connector footprint. Typical performance improvement over their standard connector counterparts is 5-10 dB over the frequency range.

Specifications

MATERIAL

Housing:	High Temperature Resistant Nylon Flammability rating UL94V-0
Contacts:	Phosphor Bronze
Contact Plating:	50 μ inches (1.27 microns) Gold Over Nickel On Mating Area, Tin-Lead Alloy On Tails

Shield: Copper Alloy, Tin-Lead Alloy Plated

ELECTRICAL

UL#	EI35615
CSA#	LR68598
EN#	60950

Ordering Information

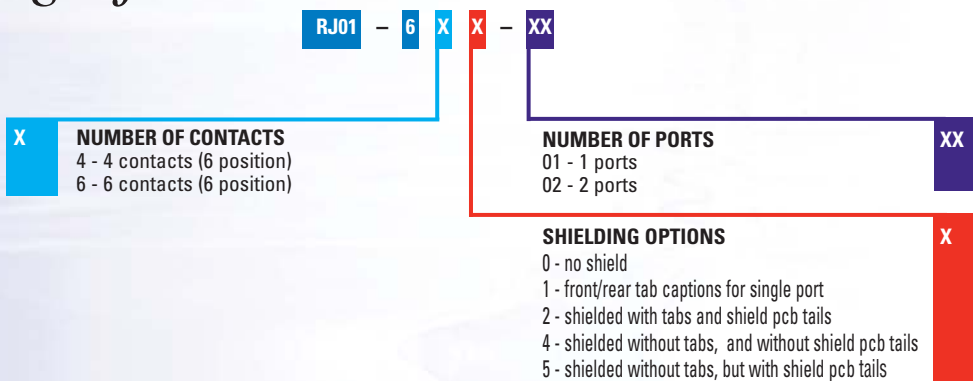

PCB LAYOUT SINGLE PORT

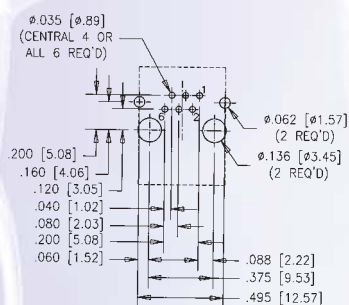

PCB LAYOUT 2 PORT

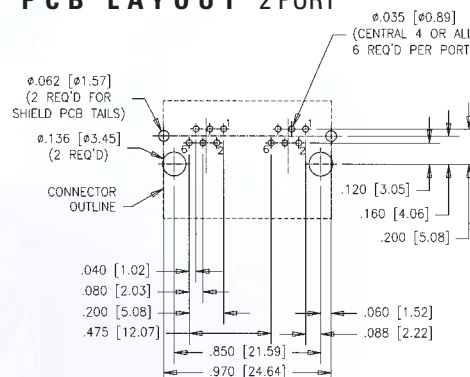

RJ01 Series

EMI QUIET - 6 POSITION

Single Port

NON-SHIELDED

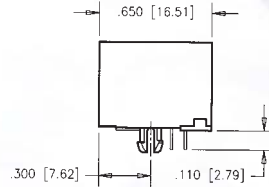
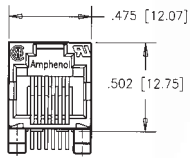

2 Port

NON-SHIELDED

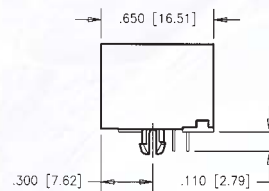
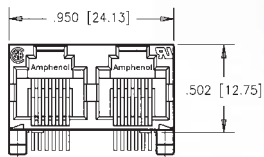

SHIELDED

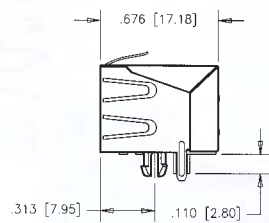
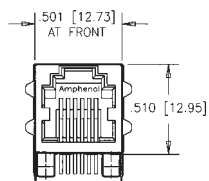

SHIELDED

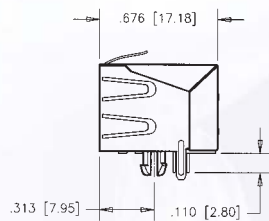
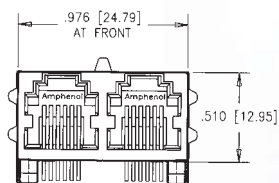

RJA02 Series

HIGH PROFILE - SINGLE PORT

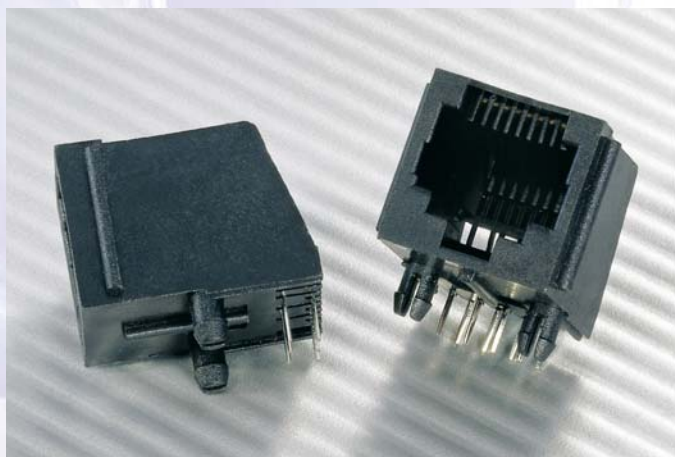

Specifications

MATERIAL

Housing: High Strength Thermoplastic Polyester Flammability Rating UL94V-0

Contacts: Phosphor Bronze

Contact Plating: Gold Over Nickel On Mating Area, Tin-Lead Alloy On Tails

ELECTRICAL

UL File # : E136228

Ordering Information

RJA02 - 1 X X - 0 X X 0

X NUMBER OF POSITIONS

8 - 8 position
6 - 6 position
4 - 4 position

X NUMBER OF CONTACTS

8 - 8 contacts (8 position)
6 - 6 contacts (6 position)
4 - 4 contacts (4 or 6 position)

OPTIONS

1 - without flanged
2 - flanged

GOLD PLATING

1 - 6 μ inches gold
2 - 15 μ inches gold
3 - 30 μ inches gold
4 - 50 μ inches gold

Single Port

NON-SHIELDED

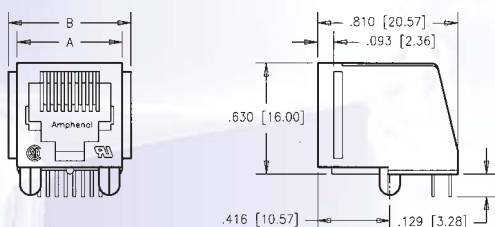

PCB LAYOUT

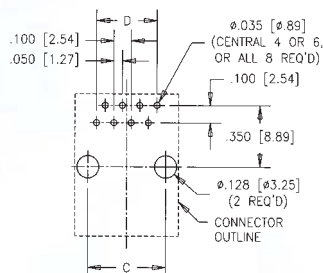

Number of positions	A	B	C	D
4	.440[11.18]	.540[13.72]	.300[7.62]	.150[3.81]
6	.520[13.21]	.620[15.75]	.400[10.16]	.250[6.35]
8	.600[15.24]	.700[17.78]	.450[11.43]	.350[8.89]

RJA03 Series

LOW PROFILE - SINGLE PORT

Material Specifications

PHYSICAL

Housing: High Strength Thermoplastic Polyester Flammability Rating UL94V-0

Contacts: Phosphor Bronze

Contact Plating: Gold Over Nickel On Mating Area, Tin-Lead Alloy On Tails

Shield: Copper Alloy, Tin-Lead Alloy Plated

ELECTRICAL

UL File #: E136228

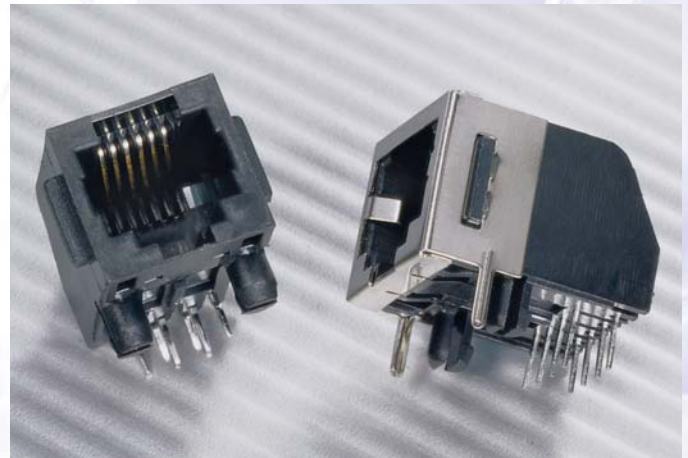

Ordering Information

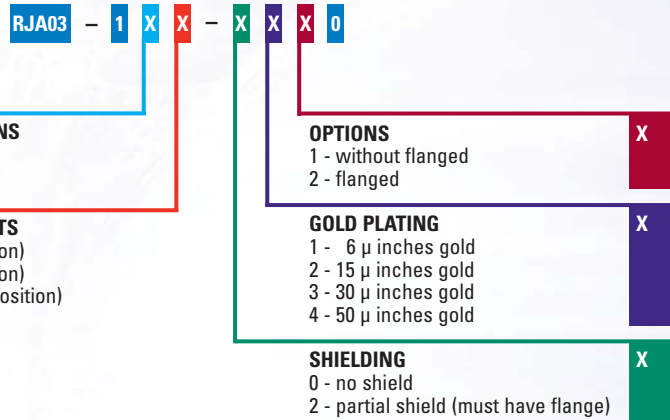

Single Port (8 & 6 Position)

NON-SHIELDED

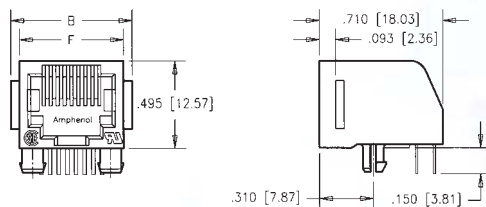

PARTIAL SHIELD

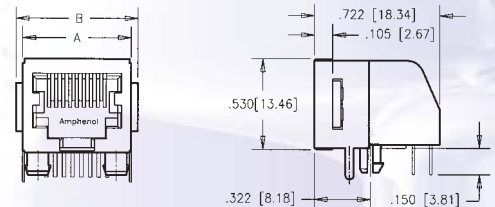

PCB LAYOUT

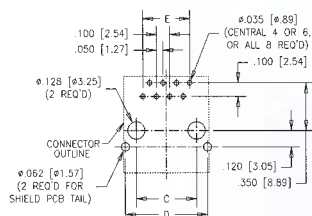

Number of positions	Number of contacts	A	B	C	D	E	F
6	4	.544 [13.83]	.620 [15.75]	.400 [10.16]	.533 [13.54]	.150 [3.81]	.520 [13.21]
6	6	.544 [13.21]	.620 [15.75]	.400 [10.16]	.533 [13.54]	.250 [6.35]	.520 [13.21]
8	8	.624 [15.24]	.700 [17.78]	.450 [11.43]	.613 [15.57]	.350 [8.89]	.600 [15.24]

RJA05 Series

ULTRA LOW PROFILE - SINGLE PORT

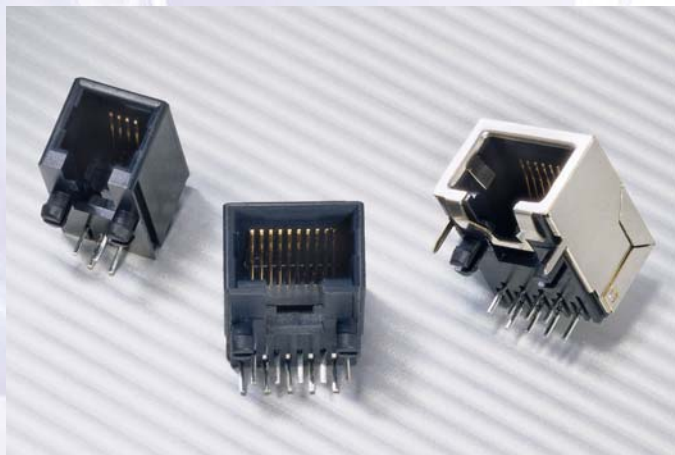

Material Specifications

PHYSICAL

Housing: High Strength Thermoplastic Polyester
Flammability Rating UL94V-0

Contacts: Phosphor Bronze

Contact Plating: Gold Over Nickel On Mating Area, Tin-Lead Alloy On Tails

Shield: Copper Alloy, Tin-Lead Alloy Plated

ELECTRICAL

UL File # : E136228

Ordering Information

RJA05 - 1 X X - X X 1 0

X

NUMBER OF POSITIONS

A - 10 position
8 - 8 position
6 - 6 position
4 - 4 position

X

NUMBER OF CONTACTS

A - 10 contacts (10 position)
8 - 8 contacts (8 position)
6 - 6 contacts (6 position)
4 - 4 contacts (4 or 6 position)

GOLD PLATING

1 - 6 μ inches gold (0.15 microns)
2 - 15 μ inches gold (0.38 microns)
3 - 30 μ inches gold (0.76 microns)
4 - 50 μ inches gold (1.27 microns)

SHIELDING

0 - no shield
1 - full shield

Single Port

NON-SHIELDED

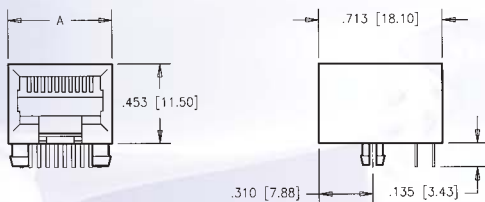

PCB LAYOUT

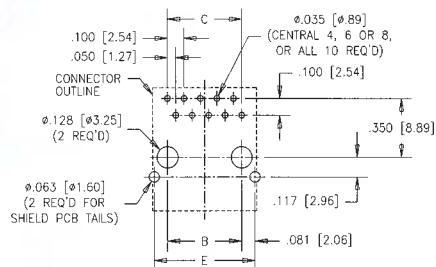

SHIELDED

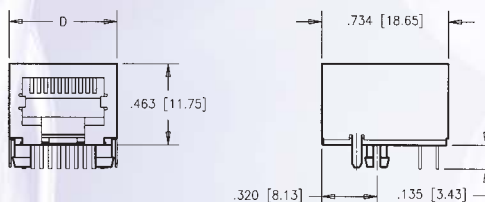

Number of positions	A	B	C	D	E
4	.440[11.18]	.300[7.62]	.150[3.81]		
6	.520[13.21]	.400[10.16]	.250[6.35]		
8	.600[15.24]	.450[11.43]	.350[8.89]	.620[15.74]	.612[15.54]
10	.600[15.24]	.450[11.43]	.450[11.43]	.620[15.74]	.612[15.54]

RJA09 Series

FULLY SHIELDED - SINGLE & MULTI PORT

Specifications

MATERIAL

Housing:	High Strength Thermoplastic Polyester Flammability Rating UL94V-0
Contacts:	Phosphor Bronze
Contact Plating:	Gold Over Nickel On Mating Area, Tin-Lead Alloy On Tails
Shield:	Copper Alloy, Tin Plated

ELECTRICAL

UL File #:	E136228
-------------------	---------

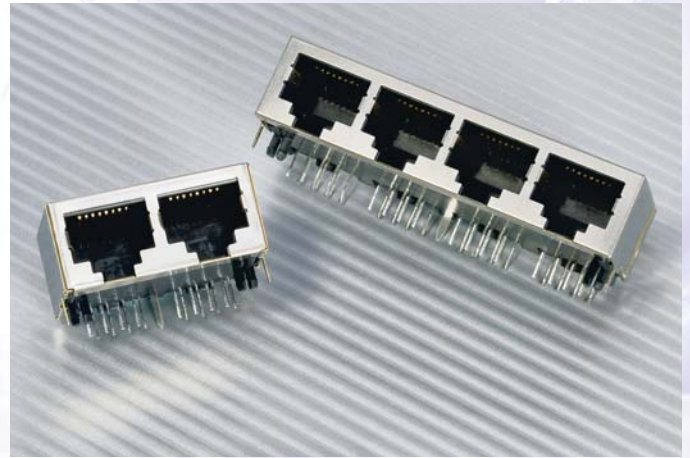

Ordering Information

RJA09 - XXX - 1 X 1 0

XXX	NUMBER OF POSITIONS
	188 - 1 port, 8 position
	1AA - 1 port, 10 position
	288 - 2 port, 8 position
	488 - 4 port, 8 position
	688 - 6 port, 8 position
	888 - 8 port, 8 position
	A88 - 10 port, 8 position
	B88 - 12 port, 8 position

GOLD PLATING	X
	1 - 6 μ inches gold
	2 - 15 μ inches gold
	3 - 30 μ inches gold
	4 - 50 μ inches gold

Single Port (8 & 10 position)

NON-SHIELDED

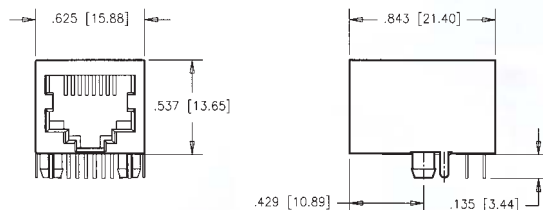

Number of positions	A
8	.350[8.89]
10	.450[11.43]

PCB LAYOUT

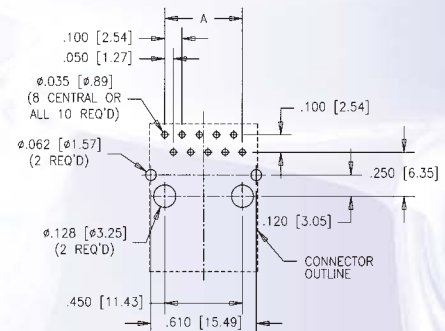

RJA09 Series

FULLY SHIELDED - SINGLE & MULTI PORT

Multiport (8 position)

NON-SHIELDED

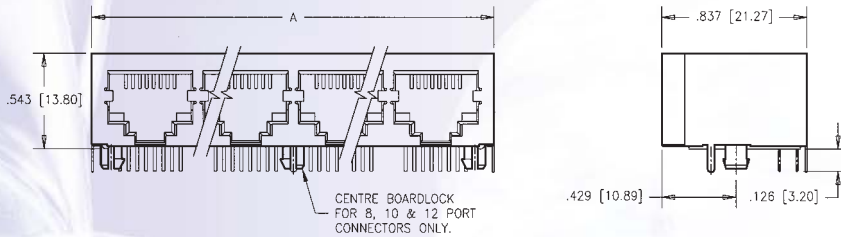

PCB LAYOUT

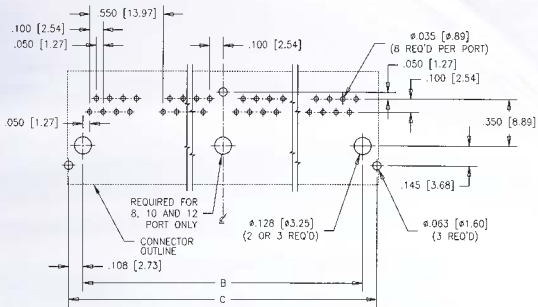

Number of ports	A	B	C
2	1.225[31.12]	1.000[25.40]	1.215[30.87]
4	2.324[59.03]	2.100[53.34]	2.315[58.81]
6	3.425[87.00]	3.200[81.28]	3.415[86.75]
8	4.525[114.94]	4.300[109.22]	4.515[114.69]
10	5.625[142.88]	5.400[137.16]	5.615[142.63]
12	6.725[170.82]	6.500[165.10]	6.715[170.57]

RJA06 Series

TOP ENTRY - SLIM PROFILE

Specifications

MATERIAL

Housing:	High Strength Thermoplastic Polyester Flammability Rating UL94V-0
Contacts:	Phosphor Bronze
Contact Plating:	Gold Over Nickel On Mating Area, Tin-Lead Alloy On Tails
Shield:	Copper Alloy, Tin-Lead Alloy Plated

ELECTRICAL

UL File #:	E136228
-------------------	---------

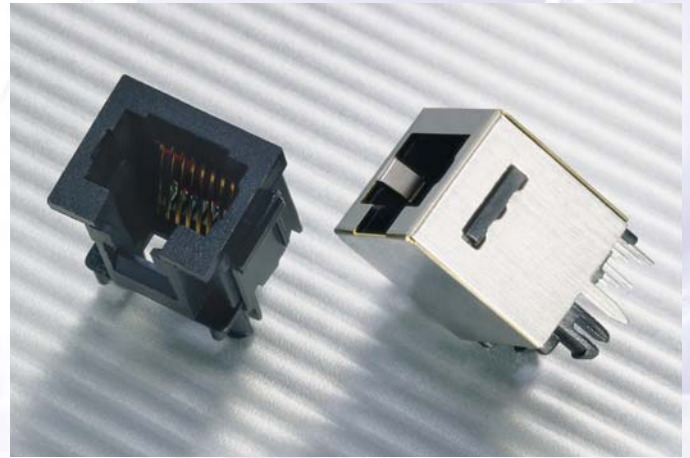

Ordering Information

RJA06 - 188 - X X X 0

X	SHIELDING OPTION 0 - no shield 1 - full shield
----------	---

OPTIONS 1 - without flanged 2 - flanged	X
--	----------

GOLD PLATING 1 - 6 μ inches gold (0.15 microns) 2 - 15 μ inches gold (0.38 microns) 3 - 30 μ inches gold (0.76 microns) 4 - 50 μ inches gold (1.27 microns)	X
--	----------

Single Port

NON-SHIELDED

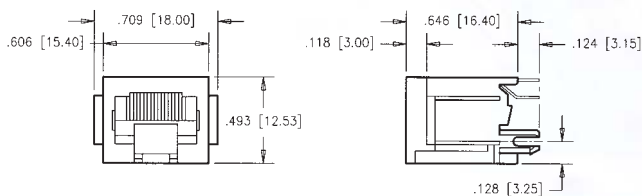

PCB LAYOUT

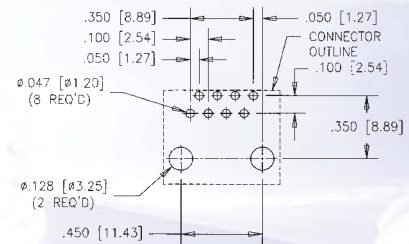

SHIELDED

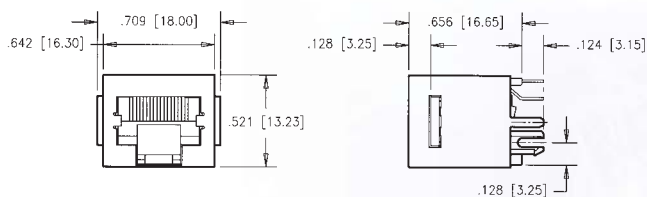

PCB LAYOUT

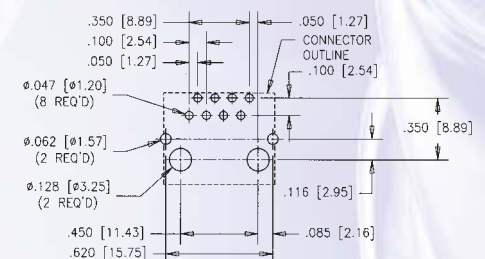

RJA08 Series

TOP ENTRY

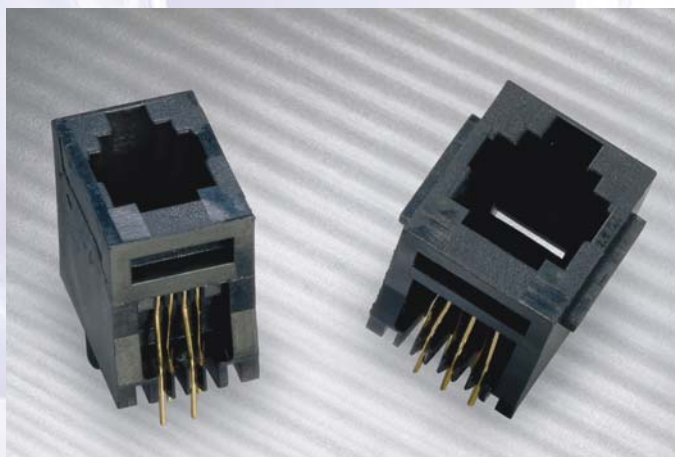

Specifications

MATERIAL

Housing: High Strength Thermoplastic Polyester Flammability Rating UL94V-0

Contacts: Phosphor Bronze

Contact Plating: Gold Over Nickel On Mating Area, Tin-Lead Alloy On Tails

ELECTRICAL

UL File # : E136228

Ordering Information

RJA08 - 1 X X - 0 X X 0

X NUMBER OF POSITIONS

A - 10 position
8 - 8 position
6 - 6 position
4 - 4 position

X NUMBER OF CONTACTS

A - 10 contacts (10 position)
8 - 8 contacts (8 position)
6 - 6 contacts (6 position)
4 - 4 contacts (4 or 6 position)

OPTIONS

1 - without flange
2 - flanged

X GOLD PLATING

1 - 6 μ inches gold (0.15 microns)
2 - 15 μ inches gold (0.38 microns)
3 - 30 μ inches gold (0.76 microns)
4 - 50 μ inches gold (1.27 microns)

NON-SHIELDED

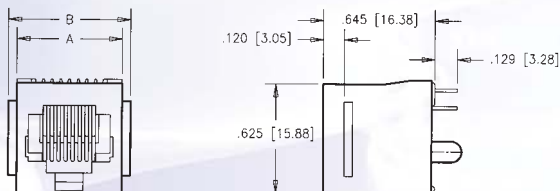

PCB LAYOUT

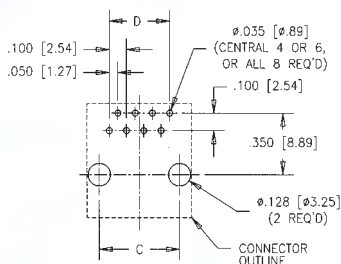

Number of positions	A	B	C	D
4	.450 [11.43]	.550 [13.97]	.300 [7.62]	.150 [3.81]
6	.530 [13.46]	.630 [16.00]	.400 [10.16]	.250 [6.35]
8	.605 [15.36]	.702 [17.84]	.465 [11.80]	.350 [8.89]

RJA07 Series

SURFACE MOUNT - SINGLE PORT

Specifications

MATERIAL

Housing: High Temperature Resistant Nylon
Flammability Rating UL94V-0

Contacts: Phosphor Bronze

Contact Plating: Gold Over Nickel On Mating Area, Tin-Lead Alloy On Tails

Shield: Copper Alloy, Tin-Lead Alloy Plated

ELECTRICAL

UL File #: E136228



Ordering Information

RJA07 - 1 X X - X X X 0

X **NUMBER OF POSITIONS**
8 - 8 position
6 - 6 position

X **NUMBER OF CONTACTS**
8 - 8 contacts (8 position)
6 - 6 contacts (6 position)
4 - 4 contacts (6 position)

OPTIONS

1 - without flanged **X**

2 - flanged (must be flanged for 'shield' option) **X**

GOLD PLATING

1 - 6 μ inches gold (0.15 microns) **X**

2 - 15 μ inches gold (0.38 microns)

3 - 30 μ inches gold (0.76 microns)

4 - 50 μ inches gold (1.27 microns)

SHIELDING

0 - no shield **X**

2 - through hole shield

3 - surface mount shield

NON-SHIELDED

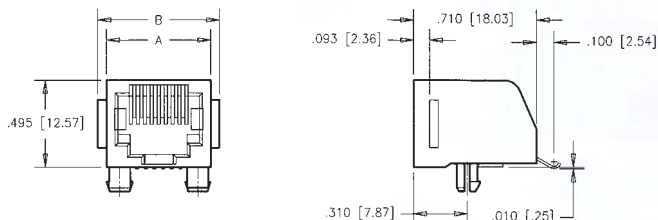

PCB LAYOUT

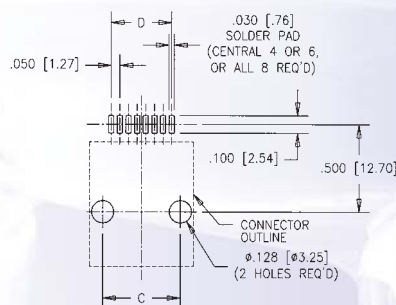

Number of positions	Number of contacts	A	B	C	D
6	4	.520 [13.21]	.620 [15.75]	.400 [10.16]	.150 [3.81]
6	6	.520 [13.21]	.620 [15.75]	.400 [10.16]	.250 [6.35]
8	8	.600 [15.24]	.700 [17.78]	.450 [11.43]	.350 [8.89]

RJA07 Series

SURFACE MOUNT - SINGLE PORT

Through Hole Shield

PARTIALY SHIELDED

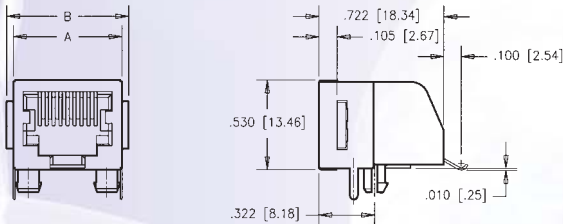

PCB LAYOUT

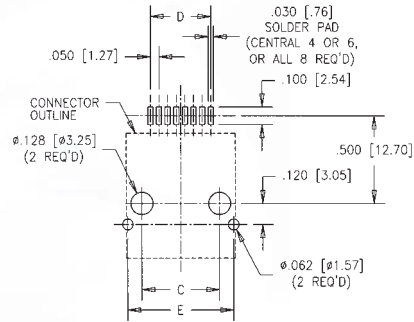

Number of positions	Number of contacts	A	B	C	D	E
6	4	.544 [13.83]	.620 [15.75]	.400 [10.16]	.150 [3.81]	.533 [13.54]
6	6	.544 [13.21]	.620 [15.75]	.400 [10.16]	.250 [6.35]	.533 [13.54]
8	8	.624 [15.24]	.700 [17.78]	.450 [11.43]	.350 [8.89]	.613 [15.57]

Surface Mount Shield

PARTIALY SHIELDED

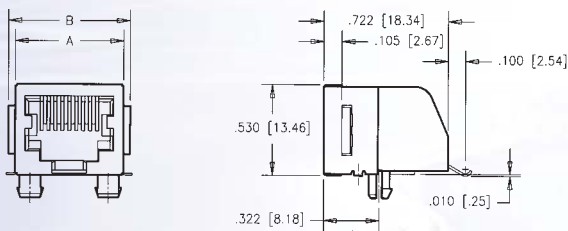

PCB LAYOUT

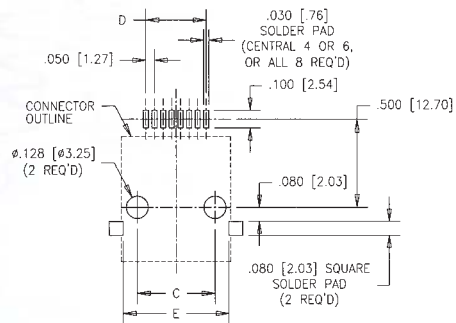

Number of positions	Number of contacts	A	B	C	D	E
6	4	.544 [13.83]	.620 [15.75]	.400 [10.16]	.150 [3.81]	.533 [13.54]
6	6	.544 [13.21]	.620 [15.75]	.400 [10.16]	.250 [6.35]	.533 [13.54]
8	8	.624 [15.24]	.700 [17.78]	.450 [11.43]	.350 [8.89]	.613 [15.57]

RJA15 Series

ULTRA LOW PROFILE - SMT SINGLE PORT

Specifications

MATERIAL

Housing: High Temperature Resistant Nylon
Flammability Rating UL94V-0

Contacts: Phosphor Bronze

Contact Plating: Gold Over Nickel On Mating Area, Tin-Lead Alloy On Tails

Shield: Copper Alloy, Tin-Lead Alloy Plated

ELECTRICAL

UL File #: E136228



Ordering Information

RJA15 - 1 X X - X X 1 0

X NUMBER OF POSITIONS

A - 10 position
8 - 8 position
6 - 6 position
4 - 4 position

X NUMBER OF CONTACTS

A - 10 contacts (10 position)
8 - 8 contacts (8 position)
6 - 6 contacts (6 position)
4 - 4 contacts (4 or 6 position)

GOLD PLATING

1 - 6 μ inches gold (0.15 microns)
2 - 15 μ inches gold (0.38 microns)
3 - 30 μ inches gold (0.76 microns)
4 - 50 μ inches gold (1.27 microns)

SHIELDING OPTION

0 - non-shielded
1 - shielded

NON-SHIELDED

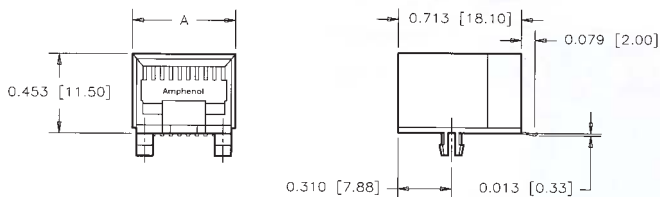

SHIELDED

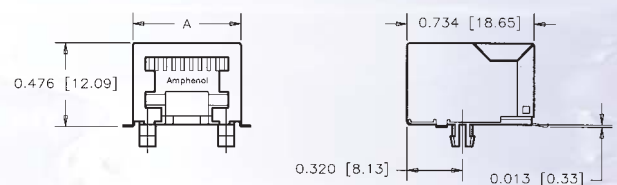

PCB LAYOUT

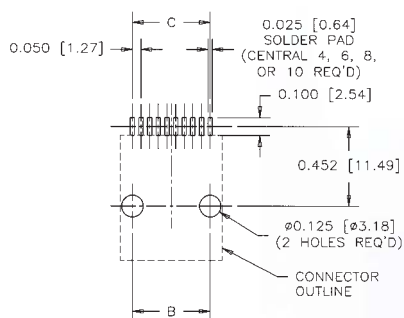

Number of positions	Unshielded		Shielded	
	A	A	B	C
4	.441 [11.21]	.469 [11.92]	.300 [7.62]	.150 [3.81]
6	.510 [12.96]	.538 [13.67]	.400 [10.16]	.250 [6.35]
8	.592 [15.03]	.620 [15.74]	.450 [11.43]	.350 [8.89]
10	.592 [15.03]	.620 [15.74]	.450 [11.43]	.450 [11.43]

RJLSE Series

ULTRA LOW PROFILE - SMT SERIES

Material Specifications

- Housing:** High temperature engineering thermoplastic, flammability rating UL 94V-0
*RoHS compliant
- Contacts:** Phosphor bronze
Plating: Gold plated on mating surfaces over 50µ" (1.27 microns) min. nickel underplate. 100µ" (2.54 microns) min. matte tin on contact tails.
- Shield:** Copper alloy, nickel plated
- Coplanarity:** The maximum gap between all terminal tails is .004" (0.10mm).

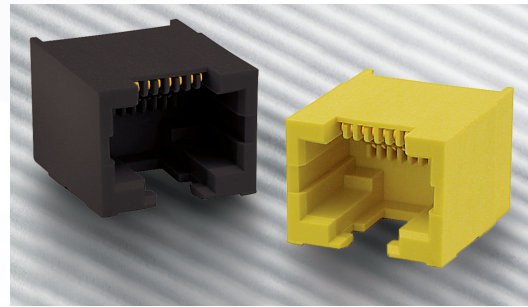

*Please visit www.amphenolcanada.com (ECO-RoHS section) for further information on RoHS products.

Ordering Information

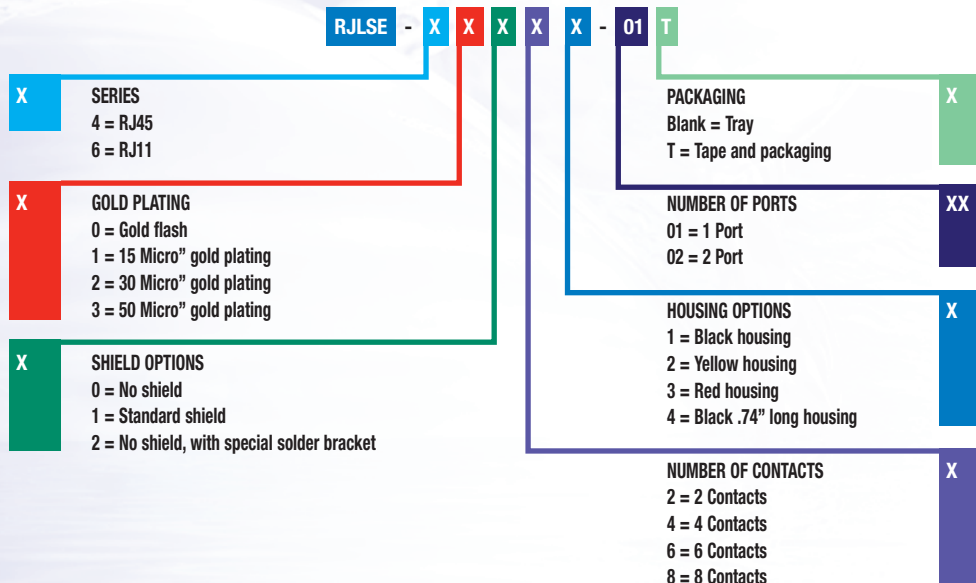

NON - SHIELDED

SHIELDED

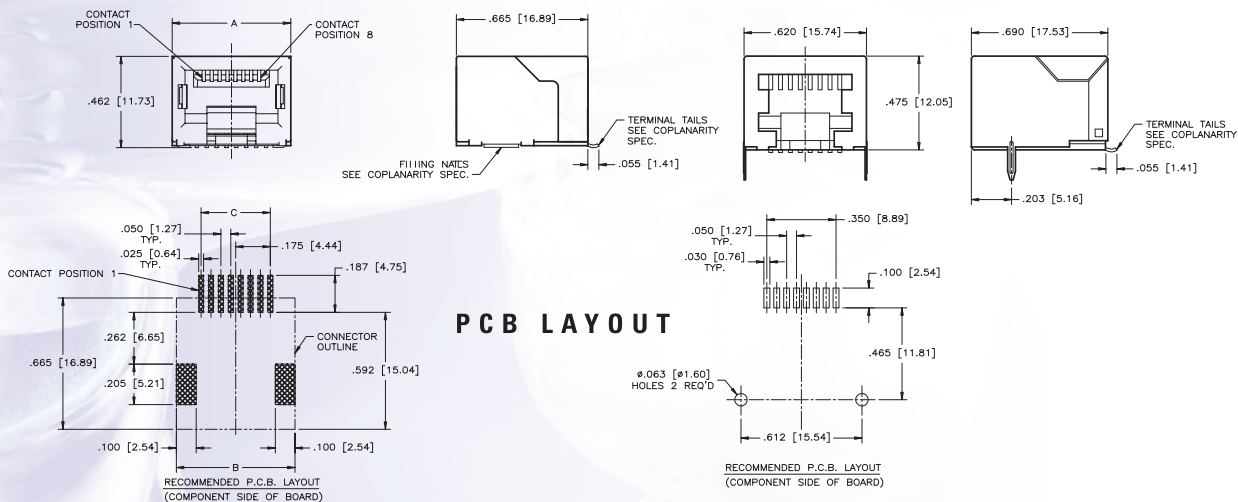

Number of positions	Unshielded		Shielded		C	D
	A	B	A	B		
6	.520 [13.21]	.532 [13.51]	.540 [13.71]	.532 [13.51]	.520 [13.21]	.250 [6.35]
8	.600 [15.24]	.612 [15.64]	.620 [15.74]	.612 [15.64]	.600 [15.24]	.350 [8.89]

