

Surface Mount Miniature Trimmers Multi-Turn Cermet Sealed

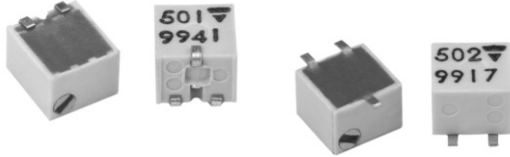

The TSM4 trimming potentiometer has been designed for surface mount applications and offers volumetric efficiency $5 \times 5 \times 3.7 \text{ mm}^3$ with high performance and stability.

The TSM4 design is suitable for both manual or automatic operation, and can withstand vapor phase and reflow soldering techniques.

FEATURES

- 0.25 W at 85 °C
- Professional grade
- Test according to CECC 41 000
- Wide ohmic range (10 Ω to 1 M Ω)
- Low contact resistance variation (2 % or 3 %)
- Small size for optimum packing density
- Suitable for both manual or automatic operation



RoHS
COMPLIANT

DIMENSIONS in millimeters

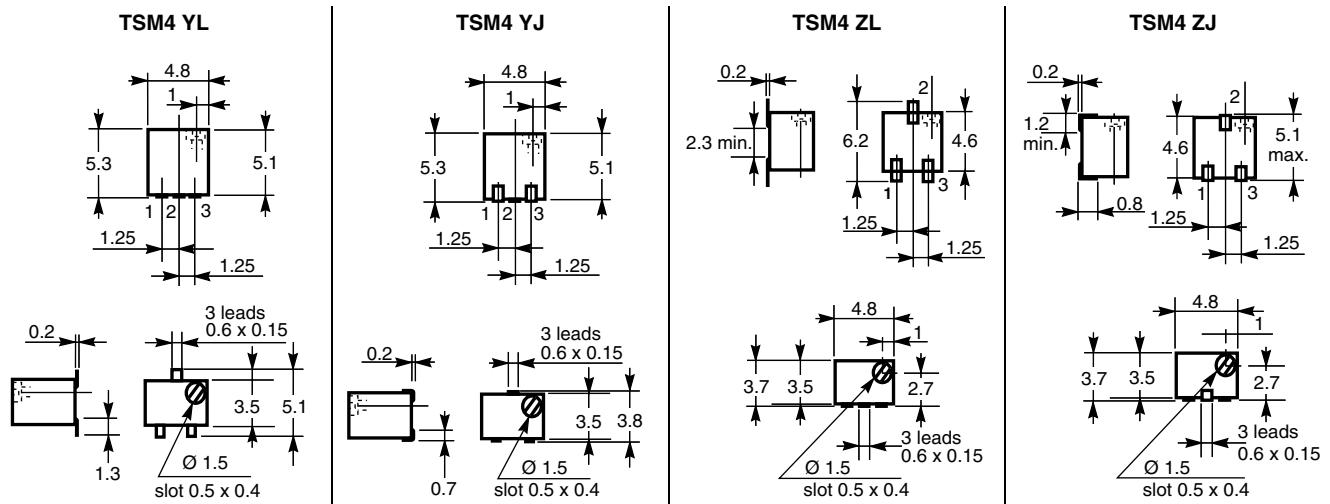

RECOMMENDED SOLDERING AREAS

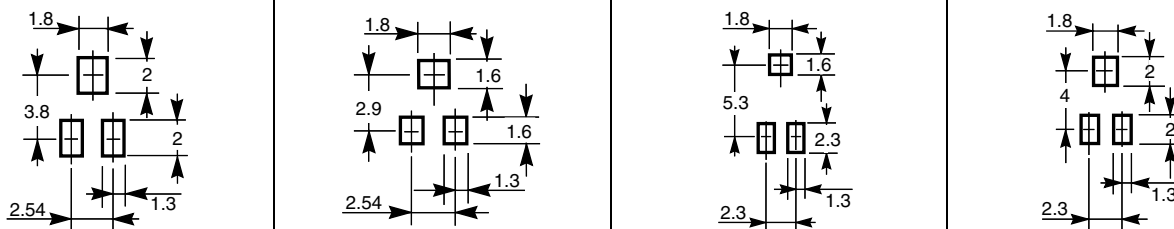

CIRCUIT DIAGRAM

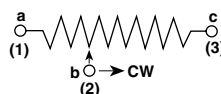

Tolerances unless otherwise specified ± 0.5



ELECTRICAL SPECIFICATIONS		
Resistive Element		Cermet
Electrical Travel		11 turns ± 2
Resistance Range		10 Ω to 1 MΩ
Standard Series		1 - 2 - 5
Tolerance Standard		± 10 %
Power Rating	Linear	0.25 W at + 85 °C
	Logarithmic	Not applicable
Temperature Coefficient		See Standard Resistance Element Table
Limiting Element Voltage (Linear Law)		200 V
Contact Resistance Variation (Typical)		2 % or 3 Ω
End Resistance (Typical)		1 Ω
Dielectric Strength (RMS)		600 V
Insulation Resistance		10 ⁶ MΩ

MECHANICAL SPECIFICATIONS

Mechanical Travel	13 turns ± 2
Operating Torque (max. Ncm)	1
End Stop Torque (Ncm)	clutch action (2 turns max)
Unit Weight (max. g)	0.15
Wiper (actual travel)	positioned at approx. 50 %

ENVIRONMENTAL SPECIFICATIONS

Temperature Range	- 55 °C to + 125 °C
Climatic Category	55/125/56
Sealing	sealed container solder immersion IP67
MSL Level	1

POWER RATING CHART

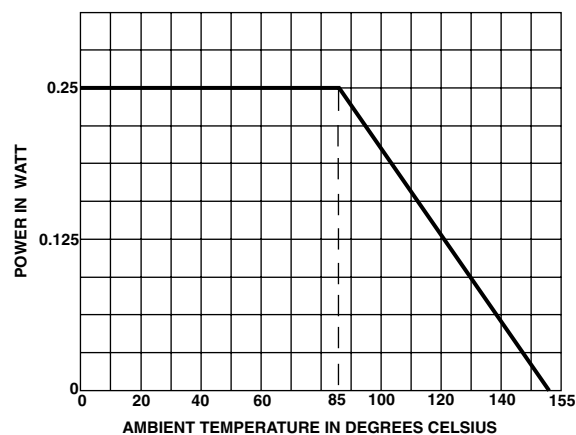

PERFORMANCE			
TESTS	CONDITIONS	TYPICAL VALUES AND DRIFTS	
		$\frac{\Delta RT}{RT}$ (%)	$\frac{\Delta R_{1-2}}{R_{1-2}}$ (%)
Load Life	1000 hours at rated power 90'/30' - ambient temperature + 85 °C	± 2 % Contact resistance variation: $\Delta > 1$ % Rn	± 3 %
Moisture Resistance	MIL STD 202 Method 106 10 cycles of 24 hours constituted with damp heat - cold - vibrations	± 2 % Dielectric strength: 1000 V RMS Insulation resistance: $> 10^4$ MΩ	± 3 %
Long Term Damp Heat	Temperature 40 °C - RH 93 % 56 days	± 2 % Dielectric strength: 1000 V _{RMS} Insulation resistance: $> 10^4$ MΩ	± 3 %
Thermal Shock	- 55 °C to + 125 °C - 5 cycles	± 1 %	$\frac{\Delta V_{1-2}}{V_{1-3}} \leq \pm 2$ %
Rotational Life (Electrical and Mechanical)	100 cycles - rated power	± (3 % + 3 Ω)	
Shock	MIL STD 202 Method 213/1 100 g - 6 ms 3 successive shocks in 3 directions	± 1 %	$\frac{\Delta V_{1-2}}{V_{1-3}} \leq \pm 1$ %
Vibration	MIL STD 202 Method 204/D 20 g - 12 hours	± 1 %	$\frac{\Delta V_{1-2}}{V_{1-3}} \leq \pm 1$ %

STANDARD RESISTANCE ELEMENT DATA					
STANDARD RESISTANCE VALUES	LINEAR LAW			TYPICAL TCR - 55 °C + 125 °C	
	MAX. POWER AT 85 °C	MAX. WORKING VOLTAGE	MAX. CUR. THROUGH ELEMENT		
Ω	W	V	mA	ppm/°C	
10	↓	1.58	158	± 100	
20		2.23	112		
50		3.53	77		
100		5.00	50		
200		7.07	35		
500		11.2	22		
1K		15.8	15.8		
2K		22.3	11.2		
5K		35.3	7.1		
10K		50.0	5.0		
20K		70.7	3.5		
50K		112	2.2		
100K		158	1.6		
200K		0.25	200		1.0
500K		0.08	200		0.4
1M	0.04	200	0.2		

MARKING

VISHAY trademark, ohmic value, manufacturing date.

The ohmic value is indicated by a 3 figure code, the first two digits are significant figures, the third one is the multiplier.

 Example: 100 = 10 Ω
 101 = 100 Ω
 102 = 1000 Ω
 503 = 50 000 Ω

SOLDERING RECOMMENDATIONS

see Application notes

PACKAGING

 On tape and reel, by 500 pieces for Z version: code TR500, or 250 pieces for Y version: code TR250.
 In bulk on request (plastic box of 50 pieces): code BO50.

Version Y

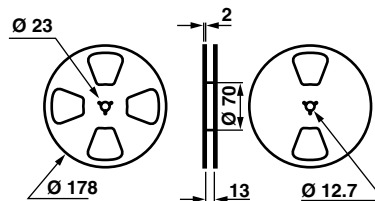

Version Z

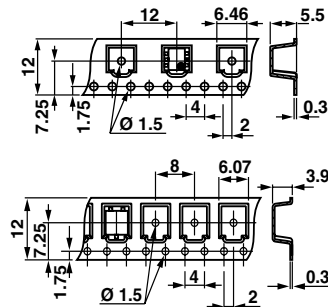
ORDERING INFORMATION

 TSM4
 SERIES

 YL
 STYLE

 500 kΩ
 OHMIC VALUE

 ± 10 %
 TOLERANCE

 TR250
 PACKAGING

 e3
 LEAD FINISH

 Version Z: code TR500
 Version Y: code TR250
 On request: BO50

e3: pure Sn

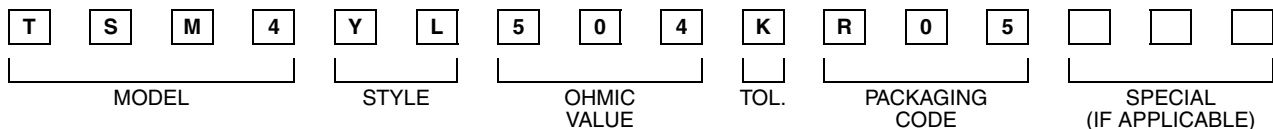
SAP PART NUMBERING GUIDELINES

See the end of this data book for conversion tables



Disclaimer

All product specifications and data are subject to change without notice.

Vishay Intertechnology, Inc., its affiliates, agents, and employees, and all persons acting on its or their behalf (collectively, "Vishay"), disclaim any and all liability for any errors, inaccuracies or incompleteness contained herein or in any other disclosure relating to any product.

Vishay disclaims any and all liability arising out of the use or application of any product described herein or of any information provided herein to the maximum extent permitted by law. The product specifications do not expand or otherwise modify Vishay's terms and conditions of purchase, including but not limited to the warranty expressed therein, which apply to these products.

No license, express or implied, by estoppel or otherwise, to any intellectual property rights is granted by this document or by any conduct of Vishay.

The products shown herein are not designed for use in medical, life-saving, or life-sustaining applications unless otherwise expressly indicated. Customers using or selling Vishay products not expressly indicated for use in such applications do so entirely at their own risk and agree to fully indemnify Vishay for any damages arising or resulting from such use or sale. Please contact authorized Vishay personnel to obtain written terms and conditions regarding products designed for such applications.

Product names and markings noted herein may be trademarks of their respective owners.