

## LZP-Series

Highest Lumen Density  
Cool White Emitter

# LZP-00CW00



### Key Features

- Highest luminous flux / area single LED emitter
  - 5500lm Cool White
  - 40mm<sup>2</sup> light emitting area
- Compact 12.0mm x 12.0mm x 6.7mm package
- Unique power package design allows emitter to be driven reliably at 1000mA/die, 90W
- Industry leading lumen maintenance
- Color Point Stability 7x improvement over Energy Star requirements
- Surface mount ceramic package with integrated glass lens
- JEDEC Level 1 for Moisture Sensitivity Level
- Lead (Pb) free and RoHS compliant
- Reflow solderable (up to 6 cycles)
- Emitter available on copper core MCPCB
- Custom TIR lens family (LLxx-3T11) specifically designed for LZP-series LEDs

### Typical Applications

- High Bay and Low Bay
- General lighting
- Stage and Studio lighting
- Architectural lighting
- Street lighting

### Description

The LZP-00CW00 Cool White LED emitter can dissipate up to 90W of power in an extremely small package. With a small 12.0mm x 12.0mm x 6.7mm footprint, this package provides unmatched luminous flux density. LedEngin's patent-pending thermally insulated phosphor layer provides spatial color uniformity across the radiation pattern and a consistent CCT, CRI over time and temperature. The high quality materials used in the package are chosen to optimize light output and minimize stresses which results in superior reliability and lumen maintenance. The robust product design thrives in outdoor applications with high ambient temperatures and high humidity.

## Table of Contents

Product Nomenclature . . . . .	3
Luminous Flux Binning. . . . .	3
Forward Voltage Binning . . . . .	3
Chromaticity Binning . . . . .	4
IPC/JEDEC Moisture Sensitivity . . . . .	5
Average Lumen Maintenance Projections . . . . .	5
Typical Radiation Pattern . . . . .	6
Absolute Maximum Ratings . . . . .	7
Optical Characteristics . . . . .	7
Electrical Characteristics . . . . .	7
Mechanical Dimensions . . . . .	8
Pin-Out . . . . .	8
Recommended Solder Pad Layout . . . . .	8
Reflow Soldering Profile . . . . .	9
Typical Relative Spectral Power Distribution . . . . .	9
Typical Relative Light Output . . . . .	10
Typical Relative Light Output over Temperature . . . . .	10
Typical Forward Current Characteristics . . . . .	11
Current De-rating Curves . . . . .	11
MCPCB Option Configuration. . . . .	12
Company Information . . . . .	13

## Product Nomenclature

The LZ Series part number designation is defined as follows:



Where:

- A – designates the number of LED die in the package (“P” for 25 die package)
- B – designates the package level (“0” for Emitter; “D” for 5-Channel MCPCB)
- C – designates the radiation pattern (“0” for Lambertian)
- D and E – designates the color (“CW” for Cool White: 4750K < CCT < 7200 K)
- F and G – designates the use of center die location (“00” vacant center location)
- H – designates the Luminous Flux bin (See Table 1)
- J and K – designates the CCT bin groups (see Figure 1 and Table 3)
- L – designates the  $V_F$  bin (See Table 2)

## Luminous Flux Bins

Table 1:

Bin Code	Minimum Luminous Flux ( $\Phi_V$ ) @ $I_F = 700\text{mA /Channel}^{[1,2]}$ (lm)	Maximum Luminous Flux ( $\Phi_V$ ) @ $I_F = 700\text{mA /Channel}^{[1,2]}$ (lm)	Typical Luminous Flux ( $\Phi_V$ ) @ $I_F = 1000\text{mA /Channel}^{[1,2]}$ (lm)
F	3,300	4,100	4,440
G	4,100	5,200	5,650

Notes for Table 1:

1. Luminous flux performance guaranteed within published operating conditions. LedEngin maintains a tolerance of  $\pm 10\%$  on flux measurements.
2. Luminous Flux typical value is for all 24 LED dies operating at rated current. The LED is configured with 4 Channels of 6 dies in series.

## Forward Voltage Bin

Table 2:

Bin Code	Minimum Forward Voltage ( $V_F$ ) @ $I_F = 700\text{mA /Channel}^{[1]}$ (V)	Maximum Forward Voltage ( $V_F$ ) @ $I_F = 700\text{mA /Channel}^{[1]}$ (V)
0	19.20 <sup>[2,3]</sup>	23.52 <sup>[2,3]</sup>

Notes for Table 2:

1. LedEngin maintains a tolerance of  $\pm 0.24\text{V}$  for forward voltage measurements.
2. All 4 white Channels have matched  $V_f$  for parallel operation
3. Forward Voltage is binned with 6 LED dies connected in series. The LED is configured with 4 Channels of 6 dies in series each.

## Cool White Chromaticity Groups

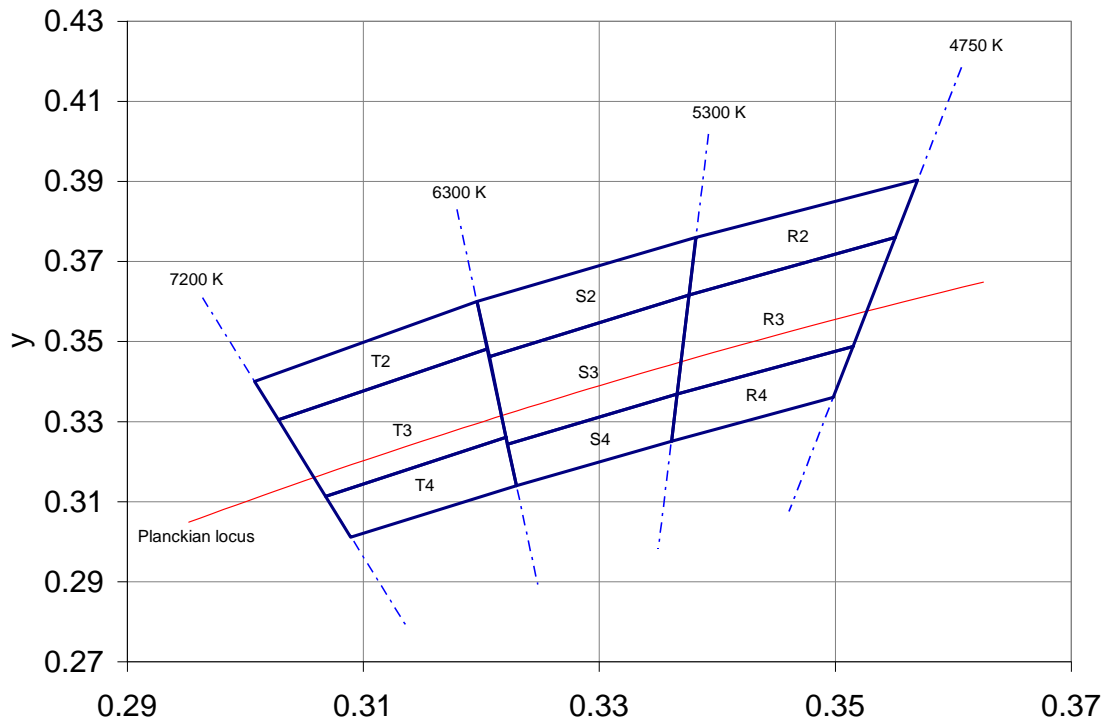

Figure 1: Standard Chromaticity Groups plotted on excerpt from the CIE 1931 (2°) x-y Chromaticity Diagram. Coordinates are listed below in Table 3.

## Cool White Chromaticity Coordinates

Table 3:

Bin Code	x	y	Typical CCT (K)	Bin Code	x	y	Typical CCT (K)	Bin Code	x	y	Typical CCT (K)
T2	0.3205	0.3481	6750	S2	0.3376	0.3616	5800	R2	0.3551	0.3760	5000
	0.3196	0.3600			0.3382	0.3760			0.3570	0.3903	
	0.3008	0.3400			0.3196	0.3600			0.3382	0.3760	
	0.3028	0.3304			0.3207	0.3462			0.3376	0.3616	
T3	0.3221	0.3261	6750	S3	0.3366	0.3369	5800	R3	0.3515	0.3487	5000
	0.3205	0.3481			0.3376	0.3616			0.3551	0.3760	
	0.3028	0.3304			0.3207	0.3462			0.3376	0.3616	
	0.3068	0.3113			0.3222	0.3243			0.3366	0.3369	
T4	0.3230	0.3140	6750	S4	0.3361	0.3251	5800	R4	0.3498	0.3360	5000
	0.3221	0.3261			0.3366	0.3369			0.3515	0.3487	
	0.3068	0.3113			0.3222	0.3243			0.3366	0.3369	
	0.3089	0.3011			0.3230	0.3140			0.3361	0.3251	

## IPC/JEDEC Moisture Sensitivity Level

Table 4 - IPC/JEDEC J-STD-20D.1 MSL Classification:

Level	Floor Life		Soak Requirements			
	Time	Conditions	Standard	Accelerated	Standard	Accelerated
	Time	Conditions	Time (hrs)	Conditions	Time (hrs)	Conditions
1	unlimited	≤ 30°C/ 85% RH	168 +5/-0	85°C/ 85% RH	n/a	n/a

Notes for Table 4:

- The standard soak time includes a default value of 24 hours for semiconductor manufacturer's exposure time (MET) between bake and bag and includes the maximum time allowed out of the bag at the distributor's facility.

## Average Lumen Maintenance Projections

Lumen maintenance generally describes the ability of a lamp to retain its output over time. The useful lifetime for solid state lighting devices (Power LEDs) is also defined as Lumen Maintenance, with the percentage of the original light output remaining at a defined time period. L70 defines the amount of operating hours at which the light output has reached 70% of its original output.

### (700mA & 1000mA) L70 de-rating

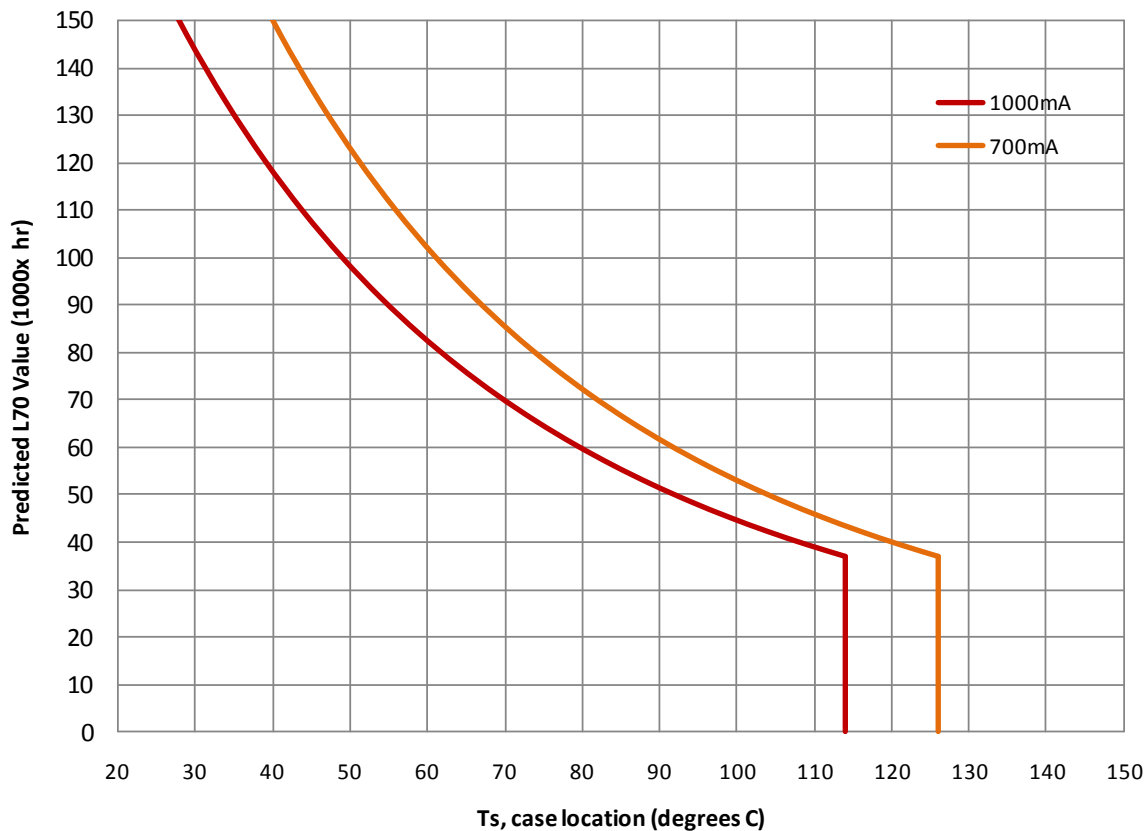

Figure 1: De-rating curve for operation of all dies at 700mA

Notes for Table 4:

- Ts is a thermal reference point. See for detail Figure 3.

## Typical Radiation Pattern

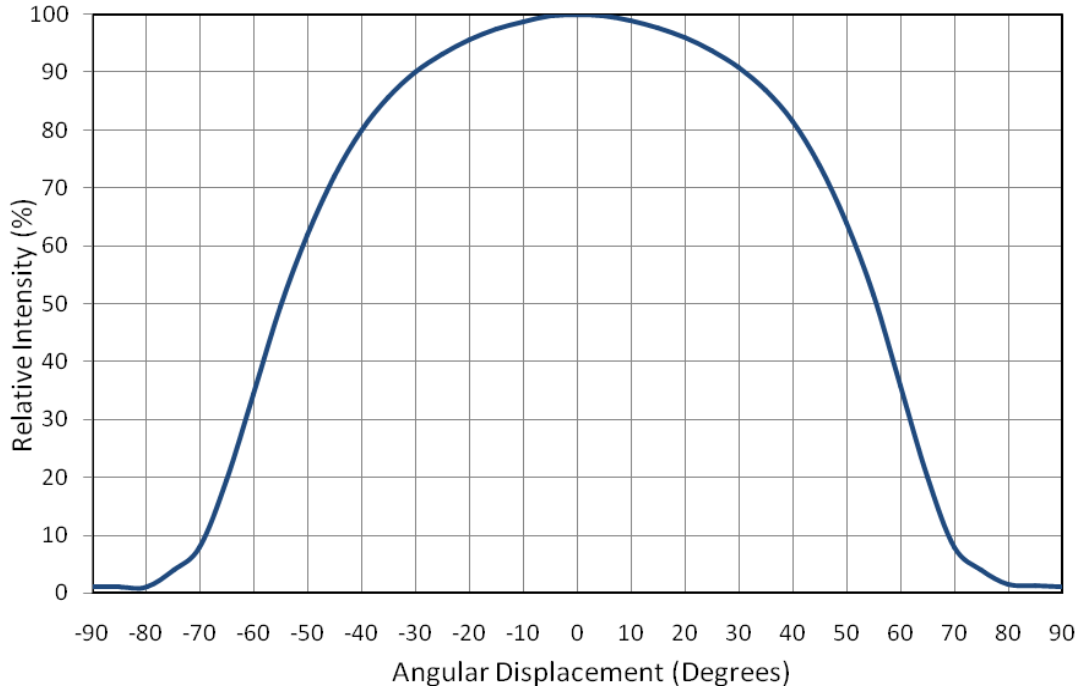

Figure 2: Typical representative spatial radiation pattern.

## Color over Angle Pattern

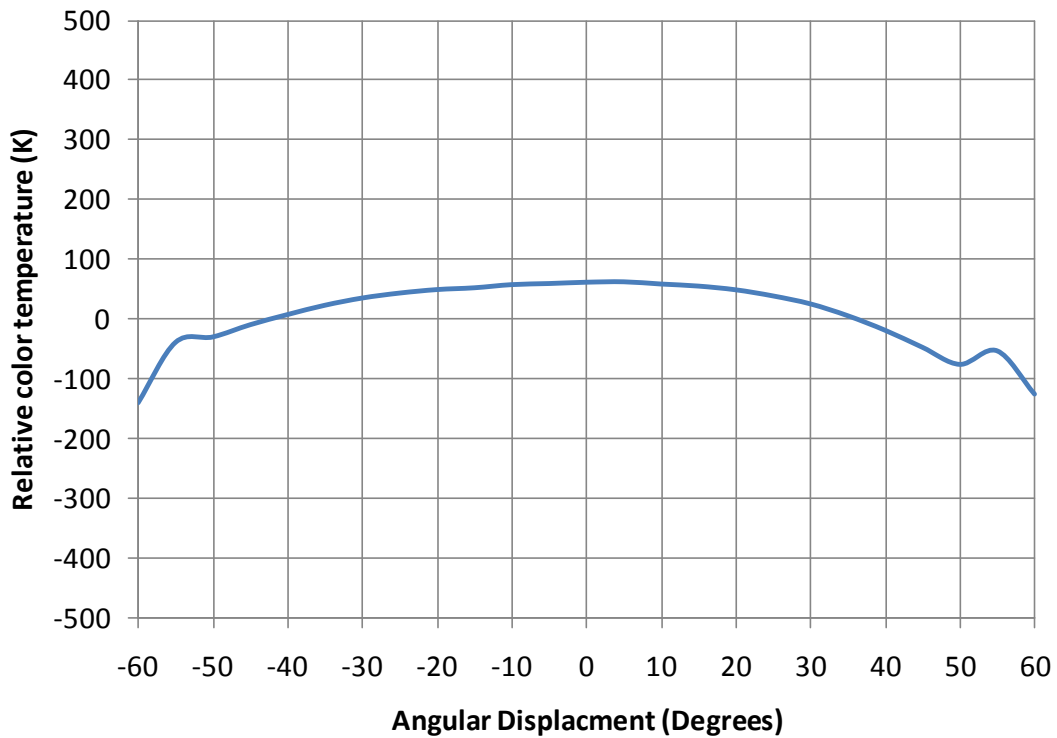

Figure 2: Typical representative color over angle pattern (includes 95% of the luminous flux).

## Absolute Maximum Ratings

Table 5:

Parameter	Symbol	Value	Unit
DC Forward Current <sup>[1]</sup>	$I_F$	1000 /Channel	mA
Peak Pulsed Forward Current <sup>[2]</sup>	$I_{FP}$	1500 /Channel	mA
Reverse Voltage	$V_R$	See Note 3	V
Storage Temperature	$T_{stg}$	-40 ~ +150	°C
Junction Temperature	$T_J$	150	°C
Soldering Temperature <sup>[4]</sup>	$T_{sol}$	260	°C
Allowable Reflow Cycles		6	
ESD Sensitivity <sup>[5]</sup>		> 8,000 V HBM Class 3B JESD22-A114-D	

Notes for Table 5:

- Maximum DC forward current (per die) is determined by the overall thermal resistance and ambient temperature. Follow the curves in Figure 10 for current de-rating.
- Pulse forward current conditions: Pulse Width  $\leq$  10msec and Duty cycle  $\leq$  10%.
- LEDs are not designed to be reverse biased.
- Solder conditions per JEDEC 020D. See Reflow Soldering Profile Figure 5.
- LedEngin recommends taking reasonable precautions towards possible ESD damages and handling the LZP-00CW00 in an electrostatic protected area (EPA). An EPA may be adequately protected by ESD controls as outlined in ANSI/ESD S6.1.

## Optical Characteristics @ $T_C = 25^\circ\text{C}$

Table 6:

Parameter	Symbol	Typical	Unit
Luminous Flux (@ $I_F = 700\text{mA}$ ) <sup>[1]</sup>	$\Phi_V$	4300	lm
Luminous Flux (@ $I_F = 1000\text{mA}$ ) <sup>[1]</sup>	$\Phi_V$	5500	lm
Luminous Efficacy (@ $I_F = 350\text{mA}$ )		100	lm/W
Correlated Color Temperature	CCT	5500	K
Chromaticity Coordinates	x,y	0.332, 0.341	
Color Rendering Index (CRI)	$R_a$	> 75	
Viewing Angle <sup>[2]</sup>	$2\Theta_{1/2}$	110	Degrees

Notes for Table 6:

- Luminous flux typical value is for all 24 LED dies operating at rated current.
- Viewing Angle is the off-axis angle from emitter centerline where the luminous intensity is  $\frac{1}{2}$  of the peak value.

## Electrical Characteristics @ $T_C = 25^\circ\text{C}$

Table 7:

Parameter	Symbol	Typical	Unit
Forward Voltage (@ $I_F = 700\text{mA}$ ) <sup>[1]</sup>	$V_F$	21.0 /Channel	V
Forward Voltage (@ $I_F = 1000\text{mA}$ ) <sup>[1]</sup>	$V_F$	21.9 /Channel	V
Temperature Coefficient of Forward Voltage <sup>[1]</sup>	$\Delta V_F / \Delta T_J$	-33.6	mV/°C
Thermal Resistance (Junction to Case)	$R\Theta_{J-C}$	0.35	°C/W

Notes for Table 7:

- Forward Voltage is measured for a single string of 6 dies connected in series. The LED is configured with 4 Channels of 6 dies in series each.

## Mechanical Dimensions (mm)

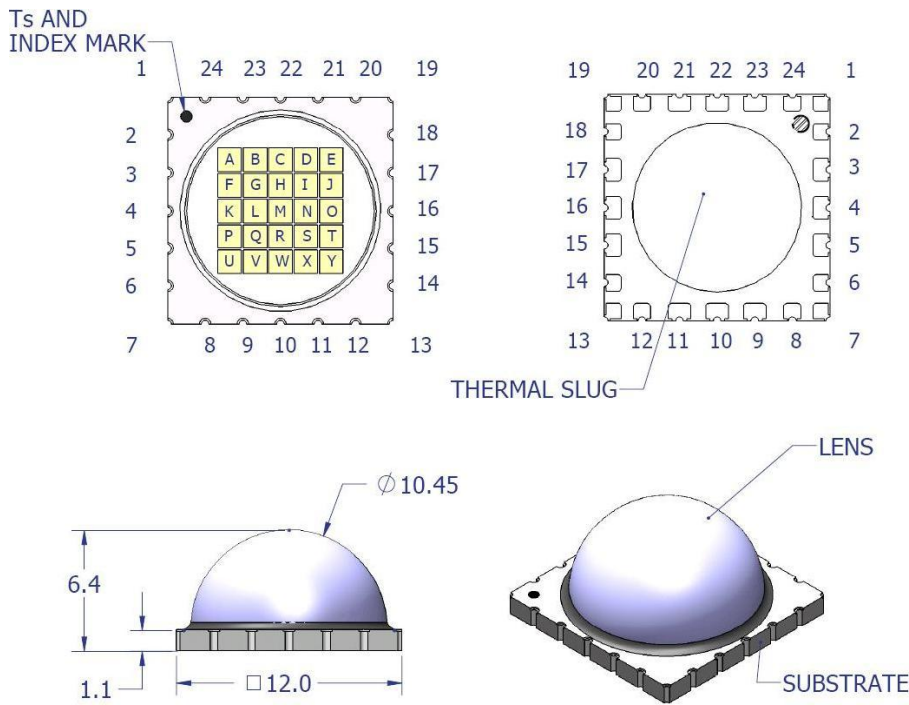

Figure 3: Package outline drawing.

Notes for Figure 3:

- Unless otherwise noted, the tolerance =  $\pm 0.20$  mm.
- Thermal slug is electrically isolated
- Ts is a thermal reference point

Pin Out				
Ch.	Pad	Die	Color	Function
1	18	E	CW	Anode
		D	CW	na
		C	CW	na
		B	CW	na
		A	CW	na
2	24	F	CW	Cathode
	17	J	CW	Anode
		I	CW	na
		H	CW	na
		G	CW	na
3	3	K	CW	Cathode
	15	O	CW	Anode
		N	CW	na
		S	CW	na
		R	CW	na
4	5	P	CW	Cathode
	14	T	CW	Anode
		Y	CW	na
		X	CW	na
		W	CW	na
5	8	U	CW	Cathode
	2	M	-	na
	23	M	-	na

## Recommended Solder Pad Layout (mm)

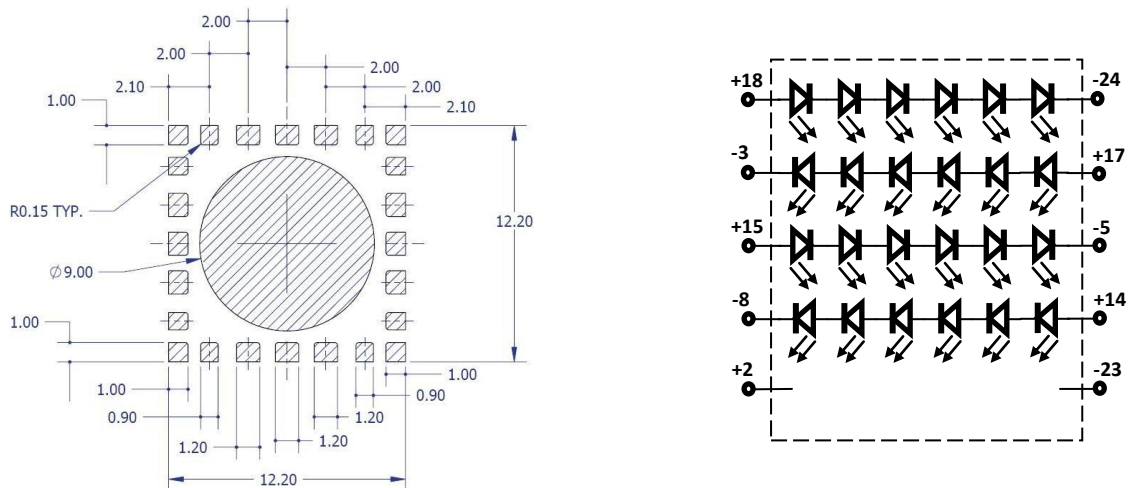

Figure 4: Recommended solder mask opening (hatched area) for anode, cathode, and thermal pad.

Note for Figure 4:

- Unless otherwise noted, the tolerance =  $\pm 0.20$  mm.



## Reflow Soldering Profile

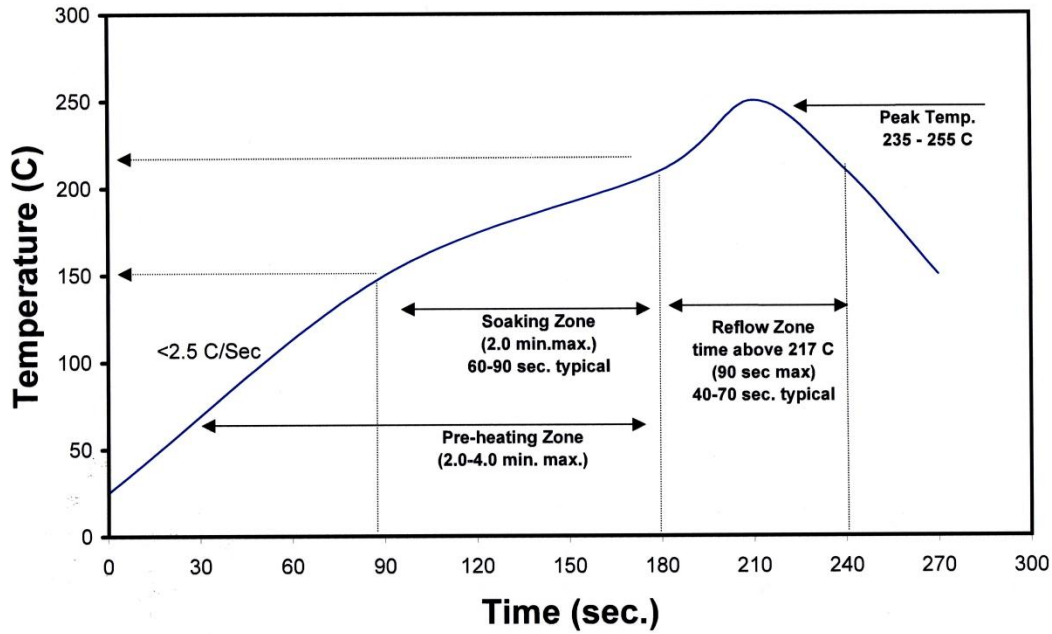

Figure 5: Reflow soldering profile for lead free soldering.

## Typical Relative Spectral Power Distribution

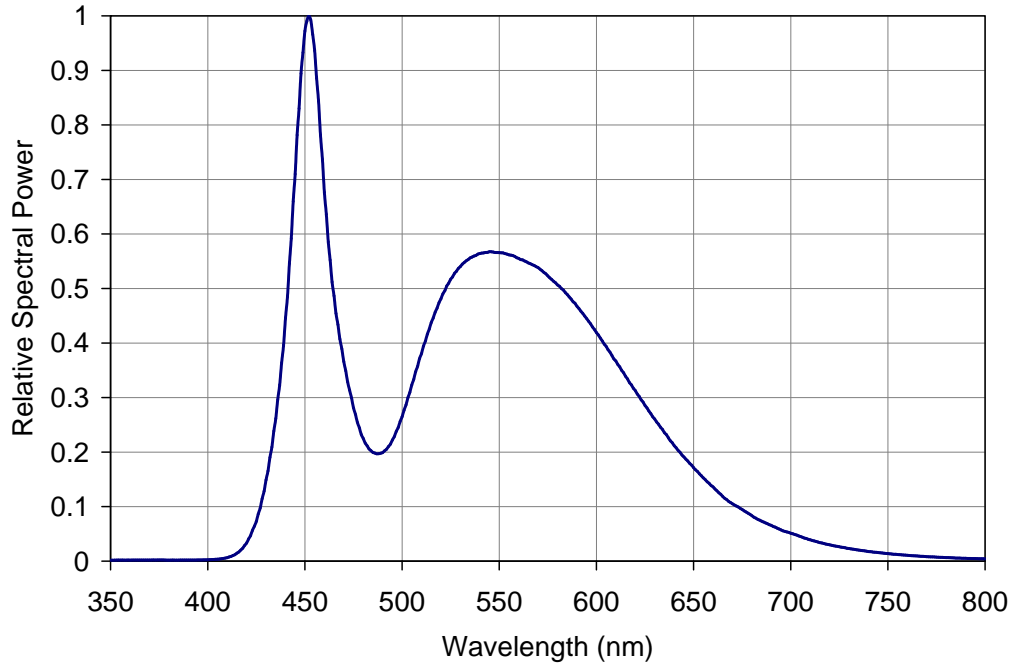

Figure 6: Typical relative spectral power vs. wavelength @  $T_c = 25^\circ\text{C}$ .

## Typical Relative Light Output

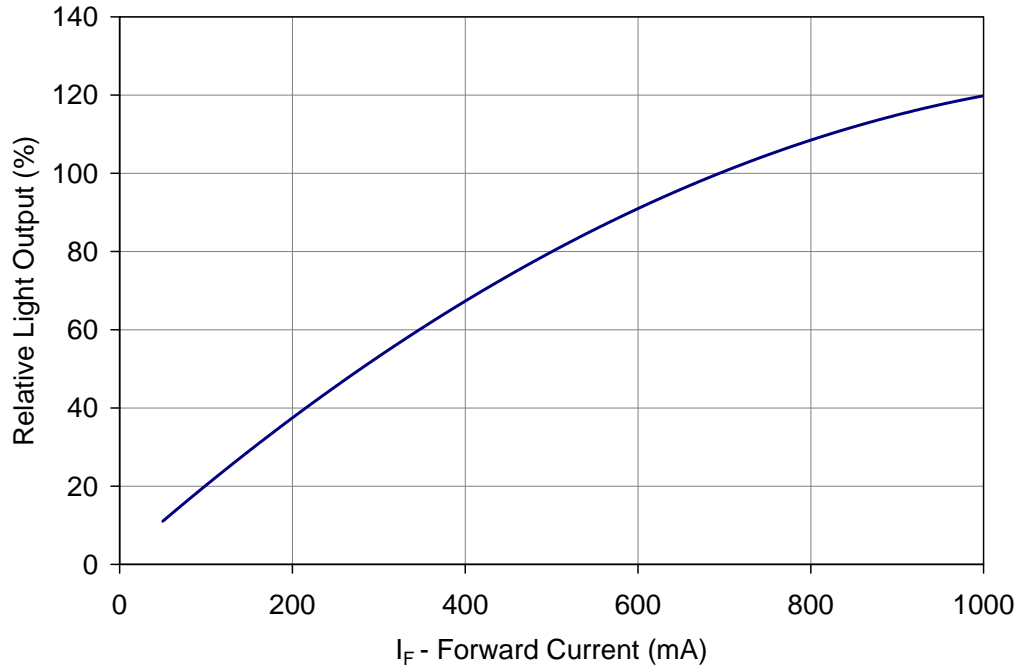

Figure 7: Typical relative light output vs. forward current @  $T_C = 25^\circ\text{C}$ .

Notes for Figure 7:

1. Luminous Flux typical value is for all 24 LED dies operating concurrently at rated current pro Channel.

## Typical Relative Light Output over Temperature

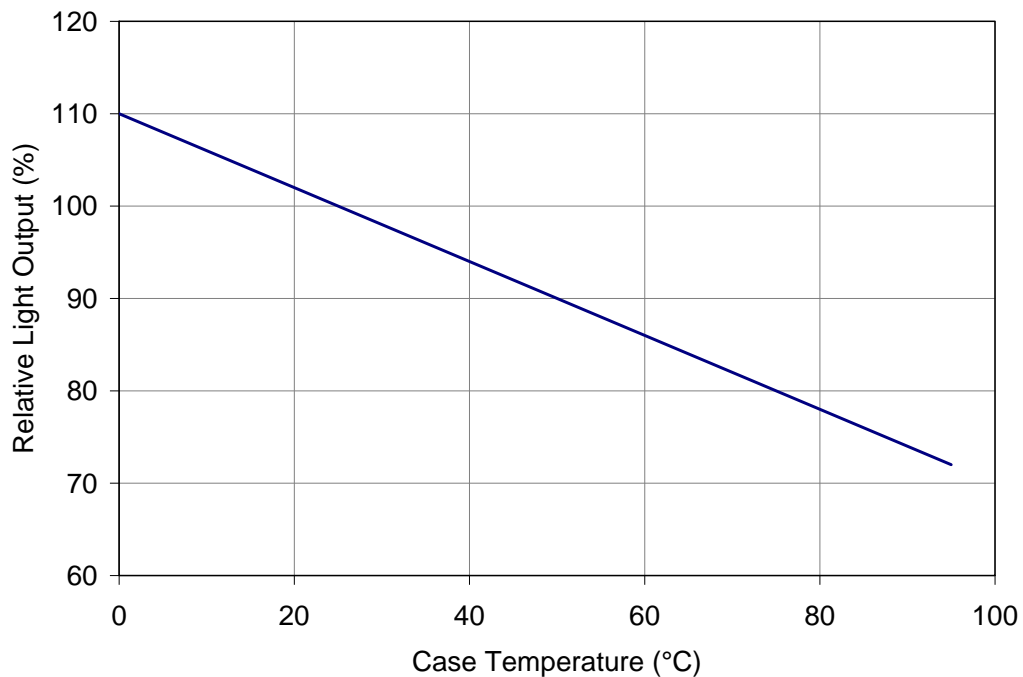

Figure 8: Typical relative light output vs. case temperature.

Notes for Figure 8:

1. Luminous Flux typical value is for all 24 LED dies operating concurrently at rated current pro Channel.

## Typical Forward Current Characteristics

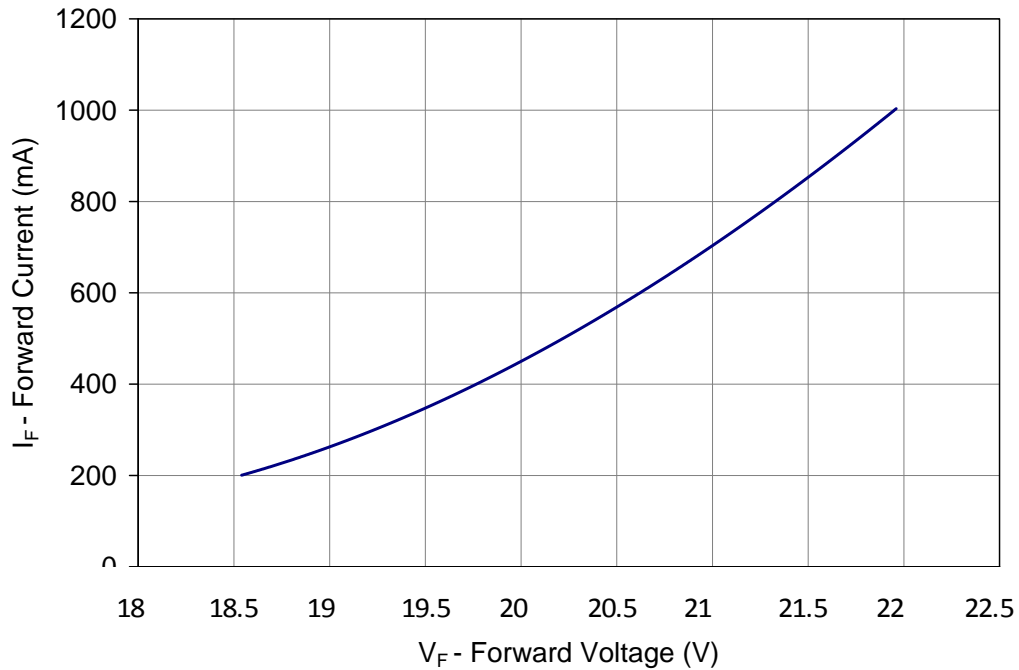

Figure 9: Typical forward current vs. forward voltage @ T<sub>C</sub> = at 25°C.

Note for Figure 9:

1. Forward Voltage is measured for a single string of 6 dies connected in series. The LED is configured with 4 Channels of 6 dies in series each.

## Current De-rating

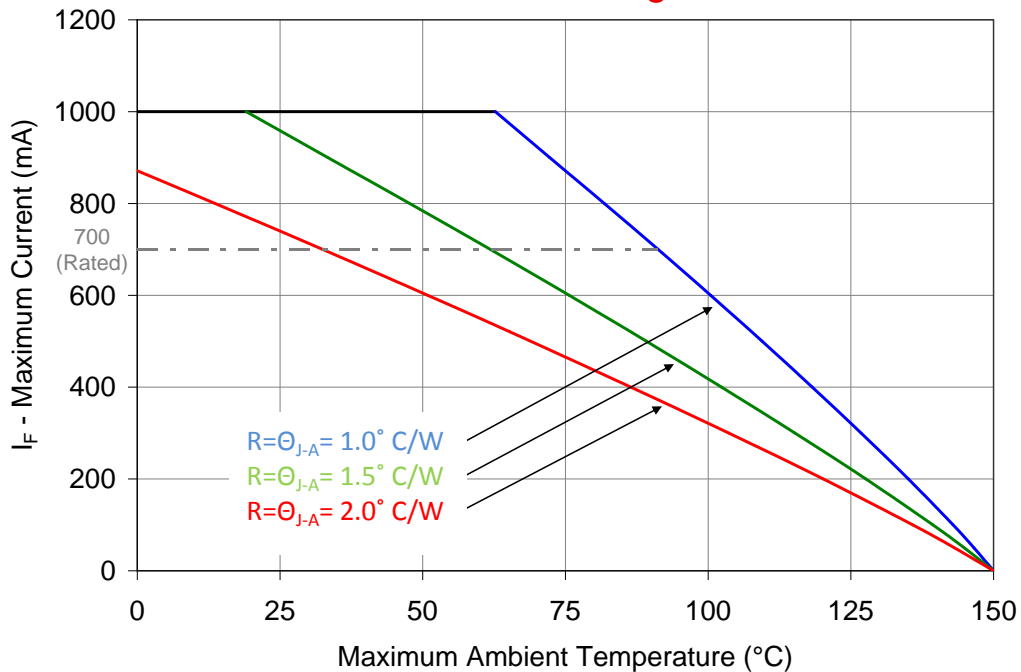

Figure 10: Maximum forward current vs. ambient temperature based on T<sub>J(MAX)</sub> = 150°C.

Notes for Figure 10:

1. Maximum current assumes that all LED dies are operating at rated current.
2. R<sub>Θ<sub>J-C</sub></sub> [Junction to Case Thermal Resistance] for the LZP-series is typically 0.35°C/W.
3. R<sub>Θ<sub>J-A</sub></sub> [Junction to Ambient Thermal Resistance] = R<sub>Θ<sub>J-C</sub></sub> + R<sub>Θ<sub>C-A</sub></sub> [Case to Ambient Thermal Resistance].

## MCPCB Option – LZP-Dxxxxx

- Emitter heat slug mounts directly onto MCPCB copper core resulting into an extremely low 0.15C/W thermal resistance
- 5 Channels: 4 independent channels with strings of 6 white LED dies in series each; 1 channel for optional center pad function (not used with LZP-0xxx00 emitter)
- MCPCB contains zener diodes for each channel resulting in enhanced ESD protection
- 6 mounting features:
  - Allow for M3 or #4 screws for attaching the MCPCB to a heat sink
  - Allow for alignment of LLxx-3T11 series lens holder

### R<sub>Θ</sub>J-B Lookup Table

Table 8:

Product	Typical Emitter R <sub>Θ</sub> J-C	+	Typical MCPCB R <sub>Θ</sub> C-B	=	Typical Emitter + MCPCB R <sub>Θ</sub> J-B <sup>[1]</sup>
LZP-series	0.35°C/W	+	0.15°C/W	=	0.50°C/W

### 4x6 MCPCB Mechanical Dimensions (mm)

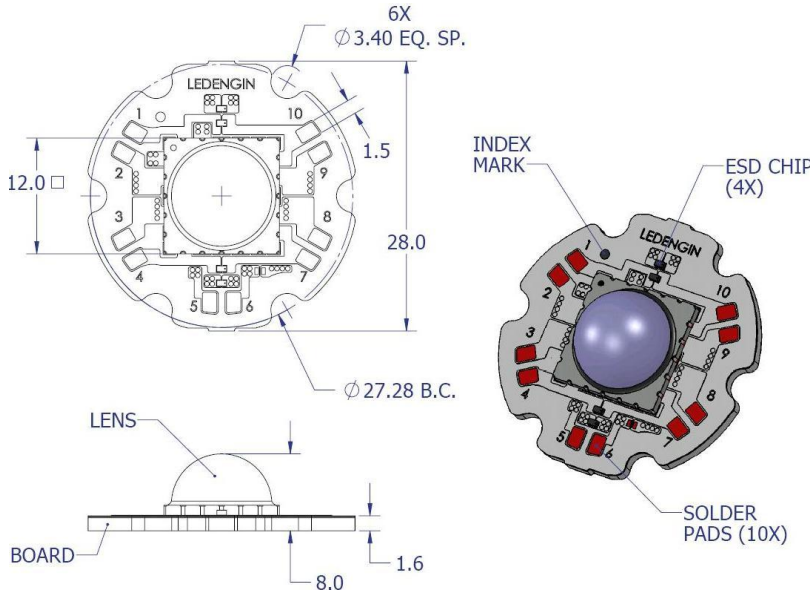
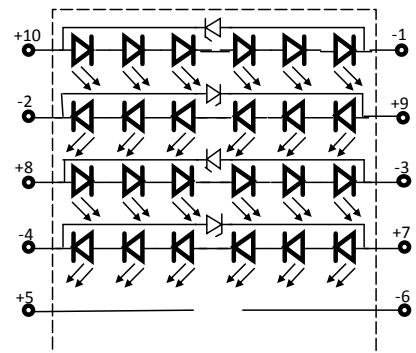

Figure 11: Standard MCPCB outline dimensions (mm).

Pin Out			
Ch.	Pad	Color	Function
1	10	CW	Anode
	1	CW	Cathode
2	9	CW	Anode
	2	CW	Cathode
3	8	CW	Anode
	3	CW	Cathode
4	7	CW	Anode
	4	CW	Cathode
5	5	-	na
	6	-	na



Note for Figure 11:

1. Unless otherwise noted, the tolerance = ± 0.20 mm.
2. Slots in MCPCB are for M3 or #4 mounting screws.
3. LedEngin recommends using plastic washers to electrically insulate screws from solder pads and electrical traces.
4. LedEngin recommends using thermally conductive adhesives when attaching the MCPCB to a heat sink.
5. MCPCB thermal resistance is based on tests conducted on a copper based SuperMCPCB from Bridge Semiconductor

## Lens Options – LLxx-xT11-H

### LLNF-3T11-H

- LZP-series lens with 23 degrees beam angle.
- Maximizes “Lux on Target”™ performance.
- Smooth light gradient eliminates hot spots and rings for superior illumination.

### Specifications – Typical Values

Parameter	Value
Viewing Angle (FWHM)	23°
Optical Efficiency	80%
Height from Seating Plane (holder)	25.0mm
Maximum Width	47.50mm

### LLFL-3T11-H

- LZP-series lens with 32 degrees beam angle.
- Maximizes “Lux on Target”™ performance.
- Smooth light gradient eliminates hot spots and rings for superior illumination.

### Specifications – Typical Values

Parameter	Value
Viewing Angle (FWHM)	32°
Optical Efficiency	80%
Height from Seating Plane (holder)	25.0mm
Maximum Width	47.50mm

## Company Information

LedEngin, Inc. is a Silicon Valley based solid-state lighting company specializing in the development and manufacturing of unprecedented high-power LED emitters, modules and replacement lamps. LedEngin's packaging technologies lead the industry with products that feature lowest thermal resistance, highest flux density and consummate reliability, enabling compact and efficient solid state lighting solutions.

LedEngin's LED emitters range from 3W to 90W with ultra-compact footprints and are available in single color products including Cool White, Neutral White, Warm White, Red, Green, Blue, Amber, Deep Red, Far Red, Dental Blue and UV as well as multi-color products with RGB, RGBA and RGBW options. LedEngin's brightest White LEDs are capable of emitting 5,500 lumens.

LedEngin's robust emitters are at the core of its unique line of modules and replacement lamps producing unmatched beam quality resulting in true Lux on Target™ for a wide variety of spot and narrow flood directional lighting applications.

LedEngin is committed to providing products that conserve natural resources and reduce greenhouse emissions.

LedEngin reserves the right to make changes to improve performance without notice.

Please contact [Sales@ledengin.com](mailto:Sales@ledengin.com) or (408) 492-0620 for more information.