



Micro Commercial Components

Micro Commercial Components  
 20736 Marilla Street Chatsworth  
 CA 91311  
 Phone: (818) 701-4933  
 Fax: (818) 701-4939

# SMBJ5.0 THRU SMBJ170CA

## Features

- For surface mount applications in order to optimize board space
- Low profile package
- Fast response time: typical less than 1.0ps from 0 volts to  $V_{BR}$  minimum
- Low inductance
- Excellent clamping capability

## Mechanical Data

- CASE: JEDEC DO-214AA
- Terminals: solderable per MIL-STD-750, Method 2026
- Polarity: Color band denotes positive end (cathode) except Bidirectional
- Maximum soldering temperature: 260°C for 10 seconds

Maximum Ratings @ 25°C Unless Otherwise Specified

Peak Pulse Current on 10/1000us waveform	$I_{PP}$	See Table 1	Note: 1
Peak Pulse Power Dissipation	$P_{PP}$	600W	Note: 1, 2
Peak Forward Surge Current	$I_{FSM}$	100A	Note: 2, 3
Operation And Storage Temperature Range	$T_J, T_{STG}$	-55°C to +150°C	
Thermal Resistance	R	25°C/W	

## Transient Voltage Suppressor 5.0 to 170 Volts 600 Watt

## DO-214AA (SMBJ) (LEAD FRAME)

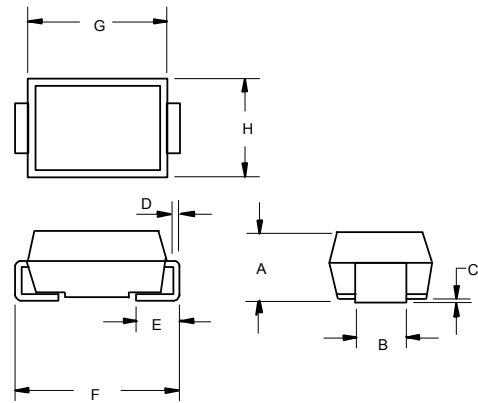

DIM	DIMENSIONS				NOTE
	INCHES		MM		
	MIN	MAX	MIN	MAX	
A	.083	.096	2.13	2.44	
B	.075	.083	1.91	2.11	
C	.002	.008	0.051	0.203	
D	.006	.012	0.152	0.305	
E	.030	.050	0.76	1.27	
F	.200	.220	5.08	5.59	
G	.160	.185	4.06	4.70	
H	.130	.155	3.30	3.94	

## NOTES:

1. Non-repetitive current pulse, per Fig.3 and derated above  $T_A=25^\circ\text{C}$  per Fig.2.
2. Mounted on 5.0mm<sup>2</sup> copper pads to each terminal.
3. 8.3ms, single half sine wave duty cycle=4 pulses per. Minute maximum.
4. Peak pulse current waveform is 10/1000us, with maximum duty Cycle of 0.01%.

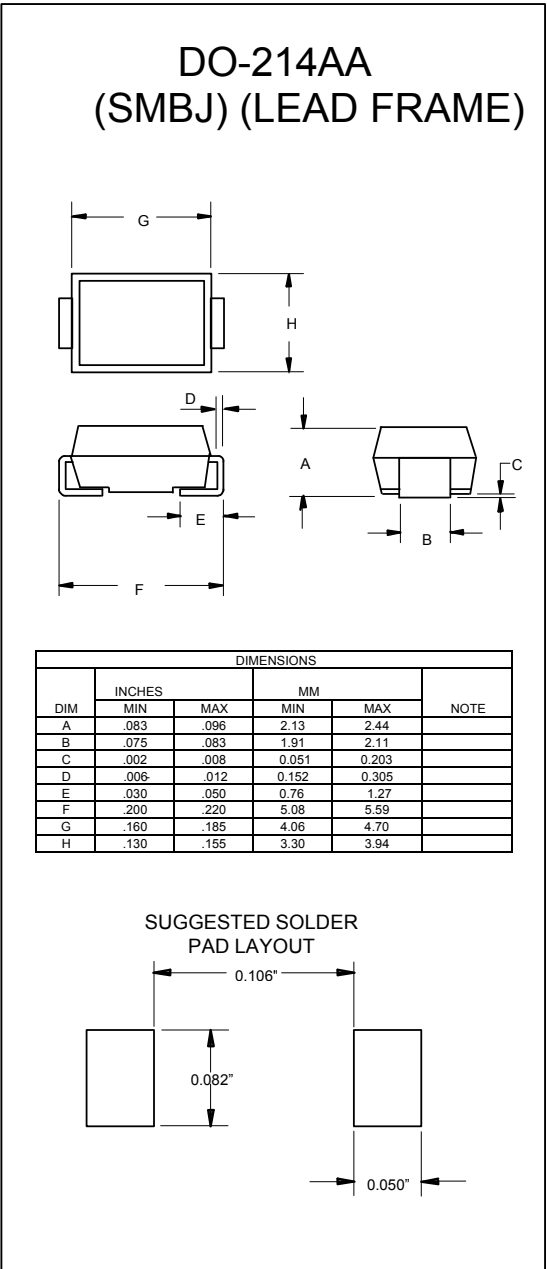

# SMBJ5.0 THRU SMBJ170CA

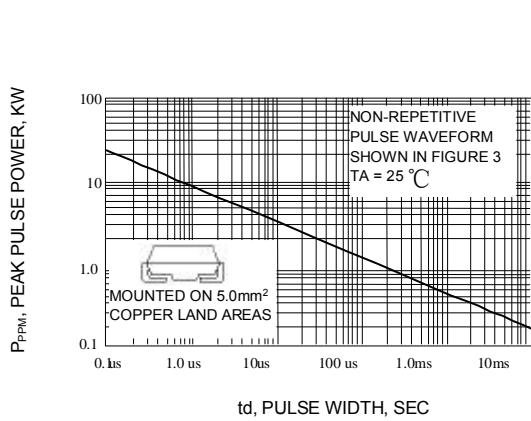

Fig. 1-PEAK PULSE POWER RATING CURVE

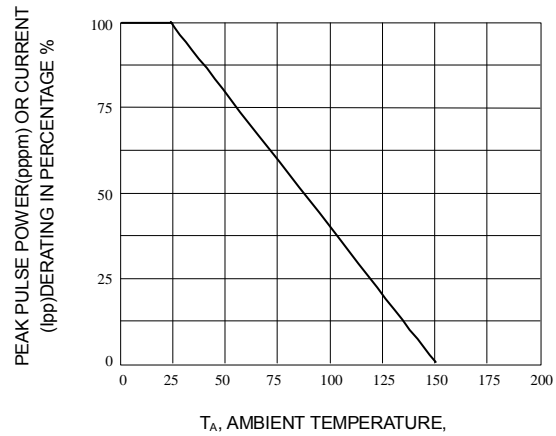

Fig. 2-PULSE DERATING CURVE

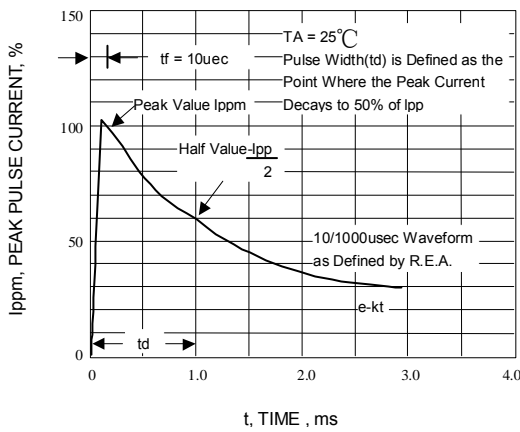

Fig. 3-PULSE WAVEFORM

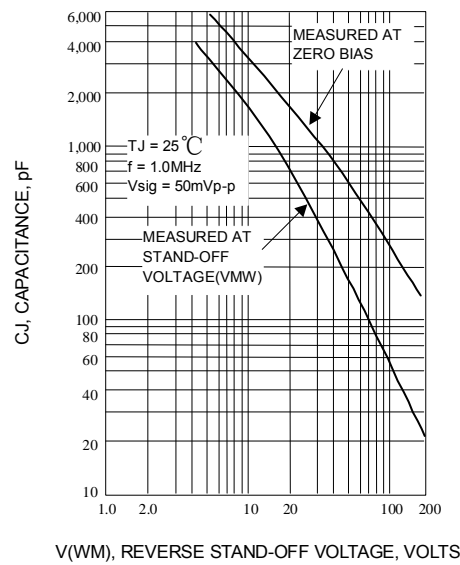

Fig. 4-TYPICAL JUNCTION CAPACITANCE

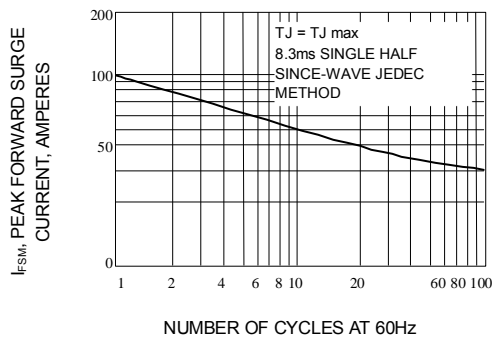

Fig. 5-MAXIMUM NON-REPETITIVE PEAK FORWARD SURGE CURRENT

# SMBJ5.0(A) thru SMBJ170(A)

Electrical Characteristics @ 25°C Unless Otherwise Specified

MCC PART NUMBER	REVERSE STAND-OFF VOLTAGE	BREAKDOWN VOLTAGE			MAXIMUM CLAMPING VOLTAGE@I <sub>PP</sub>	PEAK PULSE CURRENT I <sub>PP</sub>	MAXIMUM REVERSE LEAKAGE @V <sub>WM</sub> b	MARKING CODE
	V <sub>WM</sub>	V <sub>(BR)</sub> @I <sub>T</sub>		I <sub>T</sub> (mA)				
	VOLTS	MIN	MAX					
SMBJ5.0	5.0	6.40	7.30	10	9.6	62.5	800	KD
SMBJ5.0A	5.0	6.40	7.00	10	9.2	65.2	800	KE
SMBJ6.0	6.0	6.67	8.15	10	11.4	52.6	800	KF
SMBJ6.0A	6.0	6.67	7.37	10	10.3	58.3	800	KG
SMBJ6.5	6.5	7.22	8.82	10	12.3	48.7	500	KH
SMBJ6.5A	6.5	7.22	7.98	10	11.2	53.6	500	KK
SMBJ7.0	7.0	7.78	9.51	10	13.3	45.1	200	KL
SMBJ7.0A	7.0	7.78	8.60	10	12.0	50.0	200	KM
SMBJ7.5	7.5	8.33	10.2	1	14.3	42.0	100	KN
SMBJ7.5A	7.5	8.33	9.21	1	12.9	46.5	100	KP
SMBJ8.0	8.0	8.89	10.9	1	15.0	40.0	50	KQ
SMBJ8.0A	8.0	8.89	9.83	1	13.6	44.1	50	KR
SMBJ8.5	8.5	9.44	11.5	1	15.9	37.7	10	KS
SMBJ8.5A	8.5	9.44	10.4	1	14.4	41.7	10	KT
SMBJ9.0	9.0	10.0	12.2	1	16.9	35.5	5	KU
SMBJ9.0A	9.0	10.0	11.1	1	15.4	39.0	5	KV
SMBJ10	10	11.1	13.6	1	18.8	31.9	5	KW
SMBJ10A	10	11.1	12.3	1	17.0	35.3	5	KX
SMBJ11	11	12.2	14.9	1	20.1	29.9	5	KY
SMBJ11A	11	12.2	13.5	1	18.2	33.0	5	KZ
SMBJ12	12	13.3	16.3	1	22.0	27.3	5	LD
SMBJ12A	12	13.3	14.7	1	19.9	30.2	5	LE
SMBJ13	13	14.4	17.6	1	23.8	25.2	5	LF
SMBJ13A	13	14.4	15.9	1	21.5	27.9	5	LG
SMBJ14	14	15.6	19.1	1	25.8	23.3	5	LH
SMBJ14A	14	15.6	17.2	1	23.2	25.8	5	LK
SMBJ15	15	16.7	20.4	1	26.9	22.3	5	LL
SMBJ15A	15	16.7	18.5	1	24.4	24.0	5	LM
SMBJ16	16	17.8	21.8	1	28.8	20.8	5	LN
SMBJ16A	16	17.8	19.7	1	26.0	23.1	5	LP
SMBJ17	17	18.9	23.1	1	30.5	19.7	5	LQ
SMBJ17A	17	18.9	20.9	1	27.6	21.7	5	LR
SMBJ18	18	20.0	24.4	1	32.2	18.6	5	LS
SMBJ18A	18	20.0	22.1	1	29.2	20.5	5	LT
SMBJ20	20	22.2	27.1	1	35.8	16.7	5	LU
SMBJ20A	20	22.2	24.5	1	32.4	18.5	5	LV
SMBJ22	22	24.4	29.8	1	39.4	15.2	5	LW
SMBJ22A	22	24.4	26.9	1	35.5	16.9	5	LX
SMBJ24	24	26.7	32.6	1	43.0	14.0	5	LY
SMBJ24A	24	26.7	29.5	1	38.9	15.4	5	LZ
SMBJ26	26	28.9	35.3	1	46.6	12.4	5	MD
SMBJ26A	26	28.9	31.9	1	42.1	14.2	5	ME

# SMBJ5.0(A) thru SMBJ170(A)

Electrical Characteristics @ 25°C Unless Otherwise Specified

MCC PART NUMBER	REVERSE STAND-OFF VOLTAGE $V_{WM}$	BREAKDOWN VOLTAGE $V_{(BR)}@I_T$ (VOLTS)			MAXIMUM CLAMPING VOLTAGE@ $I_{PP}$	PEAK PULSE CURRENT $I_{PP}$	MAXIMUM REVERSE LEAKAGE @ $V_{WM}$ $I_b$	MARKING CODE
	VOLTS	MIN	MAX	$I_T$ (mA)	VOLTS	(AMPS)	( $\mu$ A)	
SMBJ28	28	31.1	38.0	1	50.0	12.0	5	MF
SMBJ28A	28	31.1	34.4	1	45.4	13.2	5	MG
SMBJ30	30	33.3	40.7	1	53.5	11.2	5	MH
SMBJ30A	30	33.3	36.8	1	48.4	12.4	5	MK
SMBJ33	33	36.7	44.9	1	59.0	10.2	5	ML
SMBJ33A	33	36.7	40.6	1	53.3	11.3	5	MM
SMBJ36	36	40.0	48.9	1	64.3	9.3	5	MN
SMBJ36A	36	40.0	44.2	1	58.1	10.3	5	MP
SMBJ40	40	44.4	54.3	1	71.4	8.4	5	MQ
SMBJ40A	40	44.4	49.1	1	64.5	9.3	5	MR
SMBJ43	43	47.8	58.4	1	76.7	7.8	5	MS
SMBJ43A	43	47.8	52.8	1	69.4	8.6	5	MT
SMBJ45	45	50.0	61.1	1	80.3	7.5	5	MU
SMBJ45A	45	50.0	55.3	1	72.7	8.3	5	MV
SMBJ48	48	53.3	65.1	1	85.5	7.0	5	MW
SMBJ48A	48	53.3	58.9	1	77.4	7.7	5	MX
SMBJ51	51	56.7	69.3	1	91.1	6.6	5	MY
SMBJ51A	51	56.7	62.7	1	82.4	7.3	5	MZ
SMBJ54	54	60.0	73.3	1	96.3	6.2	5	ND
SMBJ54A	54	60.0	66.3	1	87.1	6.9	5	NE
SMBJ58	58	64.4	78.7	1	103	5.8	5	NF
SMBJ58A	58	64.4	71.2	1	93.6	6.4	5	NG
SMBJ60	60	66.7	81.5	1	107	5.6	5	NH
SMBJ60A	60	66.7	73.7	1	96.8	6.2	5	NK
SMBJ64	64	71.1	86.9	1	114	5.3	5	NL
SMBJ64A	64	71.1	78.6	1	103	5.8	5	NM
SMBJ70	70	77.8	95.1	1	125	4.8	5	NN
SMBJ70A	70	77.8	86.0	1	113	5.3	5	NP
SMBJ75	75	83.3	102	1	134	4.5	5	NQ
SMBJ75A	75	83.3	92.1	1	121	4.9	5	NR
SMBJ78	78	86.7	106	1	139	4.3	5	NS
SMBJ78A	78	86.7	95.8	1	126	4.7	5	NT
SMBJ85	85	94.4	115	1	151	3.9	5	NU
SMBJ85A	85	94.4	104	1	137	4.4	5	NV
SMBJ90	90	100	122	1	160	3.8	5	NW
SMBJ90A	90	100	111	1	146	4.1	5	NX
SMBJ100	100	111	136	1	179	3.4	5	NY
SMBJ100A	100	111	123	1	162	3.7	5	NZ
SMBJ110	110	122	149	1	196	3.0	5	PD
SMBJ110A	110	122	135	1	177	3.4	5	PE
SMBJ120	120	133	163	1	214	2.8	5	PF
SMBJ120A	120	133	147	1	193	3.1	5	PG

# SMBJ5.0(A) thru SMBJ170(A)

Electrical Characteristics @ 25°C Unless Otherwise Specified

MCC PART NUMBER	REVERSE STAND-OFF VOLTAGE $V_{WM}$	BREAKDOWN VOLTAGE $V_{(BR)}@I_T$ (VOLTS)			MAXIMUM CLAMPING VOLTAGE@ $I_{PP}$	PEAK PULSE CURRENT $I_{PP}$	MAXIMUM REVERSE LEAKAGE @ $V_{WM}$ $I_b$	MARKING CODE
	VOLTS	MIN	MAX	$I_T$ (mA)	VOLTS	(AMPS)	( $\mu$ A)	
SMBJ130	130	144	176	1	231	2.6	5	PH
SMBJ130A	130	144	159	1	209	2.9	5	PK
SMBJ150	150	167	204	1	268	2.2	5	PL
SMBJ150A	150	167	185	1	243	2.5	5	PM
SMBJ160	160	178	218	1	287	2.1	5	PN
SMBJ160A	160	178	197	1	259	2.3	5	PP
SMBJ170	170	189	231	1	304	2.0	5	PQ
SMBJ170A	170	189	209	1	275	2.2	5	PR

# SMBJ5.0C(A) thru SMBJ170C(A)

Electrical Characteristics @ 25°C Unless Otherwise Specified

MCC PART NUMBER	REVERSE STAND-OFF VOLTAGE	BREAKDOWN VOLTAGE			MAXIMUM CLAMPING VOLTAGE@I <sub>PP</sub>	PEAK PULSE CURRENT I <sub>PP</sub>	MAXIMUM REVERSE LEAKAGE @V <sub>WM</sub> b	MARKING CODE
	V <sub>WM</sub>	V <sub>(BR)</sub> @I <sub>r</sub>		I <sub>r</sub> (mA)				
	VOLTS	MIN	MAX					
SMBJ5.0C	5.0	6.40	7.30	10	9.6	62.5	1600	AD
SMBJ5.0CA	5.0	6.40	7.00	10	9.2	65.2	1600	AE
SMBJ6.0C	6.0	6.67	8.15	10	11.4	52.6	1600	AF
SMBJ6.0CA	6.0	6.67	7.37	10	10.3	58.3	1600	AG
SMBJ6.5C	6.5	7.22	8.82	10	12.3	48.7	1000	AH
SMBJ6.5CA	6.5	7.22	7.98	10	11.2	53.6	1000	AK
SMBJ7.0C	7.0	7.78	9.51	10	13.3	45.1	400	AL
SMBJ7.0CA	7.0	7.78	8.60	10	12.0	50.0	400	AM
SMBJ7.5C	7.5	8.33	10.2	1	14.3	42.0	200	AN
SMBJ7.5CA	7.5	8.33	9.21	1	12.9	46.5	200	AP
SMBJ8.0C	8.0	8.89	10.9	1	15.0	40.0	100	AQ
SMBJ8.0CA	8.0	8.89	9.83	1	13.6	44.1	100	AR
SMBJ8.5C	8.5	9.44	11.5	1	15.9	37.7	20	AS
SMBJ8.5CA	8.5	9.44	10.4	1	14.4	41.7	20	AT
SMBJ9.0C	9.0	10.0	12.2	1	16.9	35.5	10	AU
SMBJ9.0CA	9.0	10.0	11.1	1	15.4	39.0	10	AV
SMBJ10C	10	11.1	13.6	1	18.8	31.9	5	AW
SMBJ10CA	10	11.1	12.3	1	17.0	35.3	5	AX
SMBJ11C	11	12.2	14.9	1	20.1	29.9	5	AY
SMBJ11CA	11	12.2	13.5	1	18.2	33.0	5	AZ
SMBJ12C	12	13.3	16.3	1	22.0	27.3	5	BD
SMBJ12CA	12	13.3	14.7	1	19.9	30.2	5	BE
SMBJ13C	13	14.4	17.6	1	23.8	25.2	5	BF
SMBJ13CA	13	14.4	15.9	1	21.5	27.9	5	BG
SMBJ14C	14	15.6	19.1	1	25.8	23.3	5	BH
SMBJ14CA	14	15.6	17.2	1	23.2	25.8	5	BK
SMBJ15C	15	16.7	20.4	1	26.9	22.3	5	BL
SMBJ15CA	15	16.7	18.5	1	24.4	24.0	5	BM
SMBJ16C	16	17.8	21.8	1	28.8	20.8	5	BN
SMBJ16CA	16	17.8	19.7	1	26.0	23.1	5	BP
SMBJ17C	17	18.9	23.1	1	30.5	19.7	5	BQ
SMBJ17CA	17	18.9	20.9	1	27.6	21.7	5	BR
SMBJ18C	18	20.0	24.4	1	32.2	18.6	5	BS
SMBJ18CA	18	20.0	22.1	1	29.2	20.5	5	BT
SMBJ20C	20	22.2	27.1	1	35.8	16.7	5	BU
SMBJ20CA	20	22.2	24.5	1	32.4	18.5	5	BV
SMBJ22C	22	24.4	29.8	1	39.4	15.2	5	BW
SMBJ22CA	22	24.4	26.9	1	35.5	16.9	5	BX
SMBJ24C	24	26.7	32.6	1	43.0	14.0	5	BY
SMBJ24CA	24	26.7	29.5	1	38.9	15.4	5	BZ
SMBJ26C	26	28.9	35.3	1	46.6	12.4	5	CD
SMBJ26CA	26	28.9	31.9	1	42.1	14.2	5	CE

# SMBJ5.0C(A) thru SMBJ170C(A)

Electrical Characteristics @ 25°C Unless Otherwise Specified

MCC PART NUMBER	REVERSE STAND-OFF VOLTAGE	BREAKDOWN VOLTAGE			MAXIMUM CLAMPING VOLTAGE@ $I_{PP}$	PEAK PULSE CURRENT $I_{PP}$	MAXIMUM REVERSE LEAKAGE @ $V_{WM}$	MARKING CODE
	$V_{WM}$	$V_{(BR)}$ @ $I_T$		$I_T$ (mA)				
	VOLTS	MIN	MAX					
SMBJ28C	28	31.1	38.0	1	50.0	12.0	5	CF
SMBJ28CA	28	31.1	34.4	1	45.4	13.2	5	CG
SMBJ30C	30	33.3	40.7	1	53.5	11.2	5	CH
SMBJ30CA	30	33.3	36.8	1	48.4	12.4	5	CK
SMBJ33C	33	36.7	44.9	1	59.0	10.2	5	CL
SMBJ33CA	33	36.7	40.6	1	53.3	11.3	5	CM
SMBJ36C	36	40.0	48.9	1	64.3	9.3	5	CN
SMBJ36CA	36	40.0	44.2	1	58.1	10.3	5	CP
SMBJ40C	40	44.4	54.3	1	71.4	8.4	5	CQ
SMBJ40CA	40	44.4	49.1	1	64.5	9.3	5	CR
SMBJ43C	43	47.8	58.4	1	76.7	7.8	5	CS
SMBJ43CA	43	47.8	52.8	1	69.4	8.6	5	CT
SMBJ45C	45	50.0	61.1	1	80.3	7.5	5	CU
SMBJ45CA	45	50.0	55.3	1	72.7	8.3	5	CV
SMBJ48C	48	53.3	65.1	1	85.5	7.0	5	CW
SMBJ48CA	48	53.3	58.9	1	77.4	7.7	5	CX
SMBJ51C	51	56.7	69.3	1	91.1	6.6	5	CY
SMBJ51CA	51	56.7	62.7	1	82.4	7.3	5	CZ
SMBJ54C	54	60.0	73.3	1	96.3	6.2	5	DD
SMBJ54CA	54	60.0	66.3	1	87.1	6.9	5	DE
SMBJ58C	58	64.4	78.7	1	103	5.8	5	DF
SMBJ58CA	58	64.4	71.2	1	93.6	6.4	5	DG
SMBJ60C	60	66.7	81.5	1	107	5.6	5	DH
SMBJ60CA	60	66.7	73.7	1	96.8	6.2	5	DK
SMBJ64C	64	71.1	86.9	1	114	5.3	5	DL
SMBJ64CA	64	71.1	78.6	1	103	5.8	5	DM
SMBJ70C	70	77.8	95.1	1	125	4.8	5	DN
SMBJ70CA	70	77.8	86.0	1	113	5.3	5	DP
SMBJ75C	75	83.3	102	1	134	4.5	5	DQ
SMBJ75CA	75	83.3	92.1	1	121	4.9	5	DR
SMBJ78C	78	86.7	106	1	139	4.3	5	DS
SMBJ78CA	78	86.7	95.8	1	126	4.7	5	DT
SMBJ85C	85	94.4	115	1	151	3.9	5	DU
SMBJ85CA	85	94.4	104	1	137	4.4	5	DV
SMBJ90C	90	100	122	1	160	3.8	5	DW
SMBJ90CA	90	100	111	1	146	4.1	5	DX
SMBJ100C	100	111	136	1	179	3.4	5	DY
SMBJ100CA	100	111	123	1	162	3.7	5	DZ
SMBJ110C	110	122	149	1	196	3.0	5	ED
SMBJ110CA	110	122	135	1	177	3.4	5	EE
SMBJ120C	120	133	163	1	214	2.8	5	EF
SMBJ120CA	120	133	147	1	193	3.1	5	EG

# SMBJ5.0C(A) thru SMBJ170C(A)

Electrical Characteristics @ 25°C Unless Otherwise Specified

MCC PART NUMBER	REVERSE STAND-OFF VOLTAGE $V_{WM}$	BREAKDOWN VOLTAGE $V_{(BR)}@I_T$ (VOLTS)			MAXIMUM CLAMPING VOLTAGE@ $I_{PP}$	PEAK PULSE CURRENT $I_{PP}$	MAXIMUM REVERSE LEAKAGE @ $V_{WM}$ $I_b$	MARKING CODE
	VOLTS	MIN	MAX	$I_T$ (mA)	VOLTS	(AMPS)	( $\mu$ A)	
SMBJ130C	130	144	176	1	231	2.6	5	EH
SMBJ130CA	130	144	159	1	209	2.9	5	EK
SMBJ150C	150	167	204	1	268	2.2	5	EL
SMBJ150CA	150	167	185	1	243	2.5	5	EM
SMBJ160C	160	178	218	1	287	2.1	5	EN
SMBJ160CA	160	178	197	1	259	2.3	5	EP
SMBJ170C	170	189	231	1	304	2.0	5	EQ
SMBJ170CA	170	189	209	1	275	2.2	5	ER