

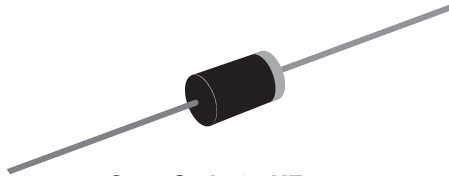

Low Capacitance TRANSZORB® Transient Voltage Suppressors



Case Style 1.5KE

PRIMARY CHARACTERISTICS	
V_{WM}	6.5 V to 28 V
P_{PPM}	1500 W
P_D	6.5 W
T_J max.	175 °C

FEATURES

- Glass passivated chip junction 
- 1500 W peak pulse power capability with a 10/1000 μ s waveform, repetitive rate (duty cycle): 0.01 %
- Excellent clamping capability
- Very fast response time
- Low incremental surge resistance
- Solder dip 260 °C, 40 seconds
- Component in accordance to RoHS 2002/95/EC and WEEE 2002/96/EC

TYPICAL APPLICATIONS

Use in sensitive electronics protection against voltage transients induced by inductive load switching and lighting on ICs, MOSFET, signal lines of sensor units for consumer, computer, industrial and telecommunication.

MECHANICAL DATA

Case: Molded epoxy body over passivated junction

Epoxy meets UL 94V-0 flammability rating

Terminals: Matte tin plated leads, solderable per J-STD-002B and JESD22-B102D

E3 suffix for commercial grade

Polarity: Color band denotes TVS cathode end

MAXIMUM RATINGS ($T_A = 25$ °C unless otherwise noted)			
PARAMETER	SYMBOL	LIMIT	UNIT
Peak pulse power dissipation with a 10/1000 μ s waveform ⁽¹⁾⁽²⁾	P_{PPM}	1500	W
Power dissipation on infinite heatsink at $T_L = 75$ °C (Fig. 2)	P_D	6.5	W
Peak power pulse surge current with a 10/1000 μ s waveform ⁽¹⁾⁽³⁾	I_{PPM}	See next table	A
Operating junction and storage temperature range	T_J, T_{STG}	- 65 to + 175	°C

Notes:

(1) Non-repetitive current pulse, per Fig. 3 and derated above $T_A = 25$ °C per Fig. 2

(2) See Fig. 1

(3) See Fig. 2

ELECTRICAL CHARACTERISTICS ($T_A = 25\text{ }^\circ\text{C}$ unless otherwise noted)											
PART NUMBER	STAND-OFF VOLTAGE V_{WM} (V)	BREAKDOWN VOLTAGE V_{BR} (V)		TEST CURRENT AT I_T (mA)	MAXIMUM REVERSE LEAKAGE AT V_{WM} I_D (μA)	MAXIMUM CLAMPING VOLTAGE AT I_{PP} V_C (V)	MAXIMUM PEAK PULSE CURRENT (FIG 3) I_{PPM} (A)	MAXIMUM JUNCTION CAPACITANCE AT 0 (V) (pF)	WORKING INVERSE BLOCKING VOLTAGE V_{WIB} (V)	MAXIMUM INVERSE BLOCKING LEAKAGE CURRENT AT V_{WIB} I_D (mA)	MINIMUM PEAK INVERSE BLOCKING VOLTAGE V_{PIB} (V)
		MIN	MAX								
LCE6.5	6.5	7.22	8.82	10.0	1000	12.3	100	100	75	1.0	100
LCE6.5A	6.5	7.22	7.98	10.0	1000	11.2	100	100	75	1.0	100
LCE7.0	7.0	7.78	9.51	10.0	500	13.3	100	100	75	1.0	100
LCE7.0A	7.0	7.78	8.60	10.0	500	12.0	100	100	75	1.0	100
LCE7.5	7.5	8.33	10.2	10.0	250	14.3	100	100	75	1.0	100
LCE7.5A	7.5	8.33	9.21	10.0	250	12.9	100	100	75	1.0	100
LCE8.0	8.0	8.89	10.9	1.0	100	15.0	100	100	75	1.0	100
LCE8.0A	8.0	8.89	9.83	1.0	100	13.6	100	100	75	1.0	100
LCE8.5	8.5	9.44	11.5	1.0	50.0	15.9	94	100	75	1.0	100
LCE8.5A	8.5	9.44	10.4	1.0	50.0	14.4	100	100	75	1.0	100
LCE9.0	9.0	10.0	12.2	1.0	10.0	16.9	89	100	75	1.0	100
LCE9.0A	9.0	10.0	11.1	1.0	10.0	15.4	97	100	75	1.0	100
LCE10	10	11.1	13.6	1.0	5.0	18.8	80	100	75	1.0	100
LCE10A	10	11.1	12.3	1.0	5.0	17.0	88	100	75	1.0	100
LCE11	11	12.2	14.9	1.0	5.0	20.1	74	100	75	1.0	100
LCE11A	11	12.2	13.5	1.0	5.0	18.2	82	100	75	1.0	100
LCE12	12	13.3	16.3	1.0	5.0	22.0	68	100	75	1.0	100
LCE12A	12	13.3	14.7	1.0	5.0	19.9	75	100	75	1.0	100
LCE13	13	14.4	17.6	1.0	5.0	23.8	63	100	75	1.0	100
LCE13A	13	14.4	15.9	1.0	5.0	21.5	70	100	75	1.0	100
LCE14	14	15.6	19.1	1.0	5.0	25.8	58	100	75	1.0	100
LCE14A	14	15.6	17.2	1.0	5.0	23.2	65	100	75	1.0	100
LCE15	15	16.7	20.4	1.0	5.0	26.9	56	100	75	1.0	100
LCE15A	15	16.7	18.5	1.0	5.0	24.4	61	100	75	1.0	100
LCE16	16	17.8	21.8	1.0	5.0	28.8	52	100	75	1.0	100
LCE16A	16	17.8	19.7	1.0	5.0	26.0	57	100	75	1.0	100
LCE17	17	18.9	23.1	1.0	5.0	30.5	49	100	75	1.0	100
LCE17A	17	18.9	20.9	1.0	5.0	27.6	54	100	75	1.0	100
LCE18	18	20.0	24.4	1.0	5.0	32.2	46	100	75	1.0	100
LCE18A	18	20.0	22.1	1.0	5.0	29.2	51	100	75	1.0	100
LCE20	20	22.2	27.1	1.0	5.0	35.8	42	100	75	1.0	100
LCE20A	20	22.2	24.5	1.0	5.0	32.4	46	100	75	1.0	100
LCE22	22	24.4	29.8	1.0	5.0	39.4	38	100	75	1.0	100
LCE22A	22	24.4	26.9	1.0	5.0	35.5	42	100	75	1.0	100
LCE24	24	26.7	32.6	1.0	5.0	43.0	35	100	75	1.0	100
LCE24A	24	26.7	29.5	1.0	5.0	38.9	39	100	75	1.0	100
LCE26	26	28.9	35.3	1.0	5.0	46.6	32	100	75	1.0	100
LCE26A	26	28.9	31.9	1.0	5.0	42.1	36	100	75	1.0	100
LCE28	28	31.1	38.0	1.0	5.0	50.1	30	100	75	1.0	100
LCE28A	28	31.1	34.4	1.0	5.0	45.5	33	100	75	1.0	100

Note:

(1) All the above devices are UL listed for Telecom application protection 497B, file number E136766

ORDERING INFORMATION (Example)				
PREFERRED P/N	UNIT WEIGHT (g)	PREFERRED PACKAGE CODE	BASE QUANTITY	DELIVERY MODE
LCE6.5-E3/54	0.968	54	1400	13" diameter paper tape and reel

RATINGS AND CHARACTERISTICS CURVES

($T_A = 25\text{ }^\circ\text{C}$ unless otherwise noted)

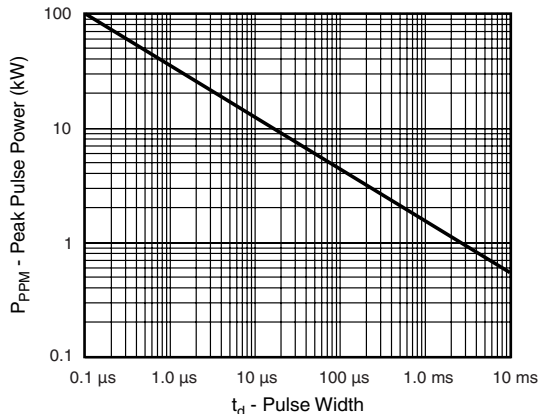

Figure 1. Peak Pulse Power Rating Curve

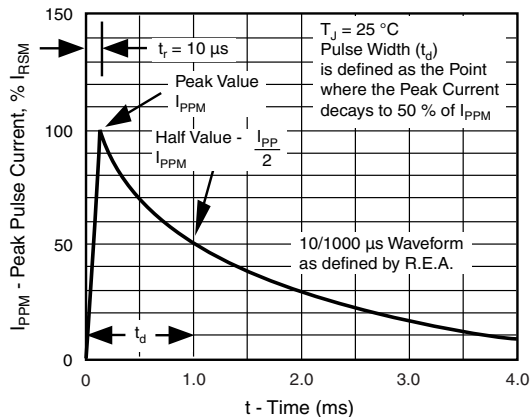

Figure 3. Pulse Waveform

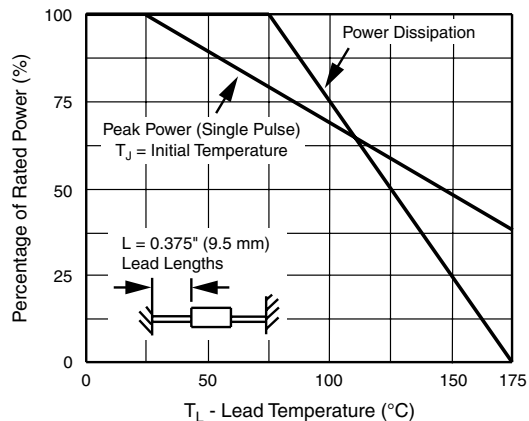
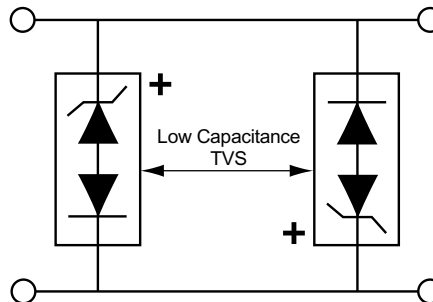

Figure 2. Power Derating Curve



Application Note: Device must be used with two units in parallel, opposite in polarity as shown in circuit for AC signal line protection.

Figure 4. AC Line Protection Application

Schematic

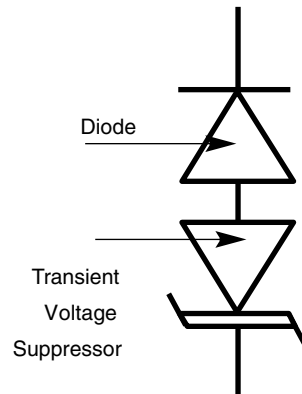

PACKAGE OUTLINE DIMENSIONS in inches (millimeters)

Case Style 1.5KE

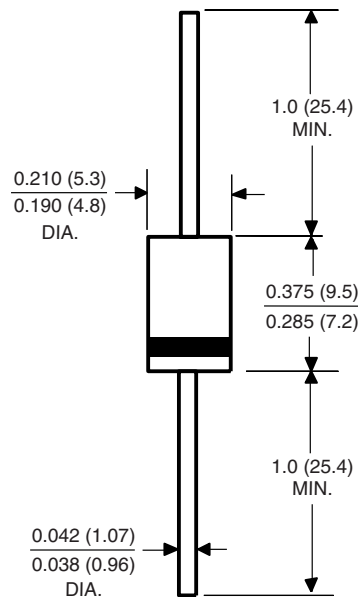



Disclaimer

All product specifications and data are subject to change without notice.

Vishay Intertechnology, Inc., its affiliates, agents, and employees, and all persons acting on its or their behalf (collectively, "Vishay"), disclaim any and all liability for any errors, inaccuracies or incompleteness contained herein or in any other disclosure relating to any product.

Vishay disclaims any and all liability arising out of the use or application of any product described herein or of any information provided herein to the maximum extent permitted by law. The product specifications do not expand or otherwise modify Vishay's terms and conditions of purchase, including but not limited to the warranty expressed therein, which apply to these products.

No license, express or implied, by estoppel or otherwise, to any intellectual property rights is granted by this document or by any conduct of Vishay.

The products shown herein are not designed for use in medical, life-saving, or life-sustaining applications unless otherwise expressly indicated. Customers using or selling Vishay products not expressly indicated for use in such applications do so entirely at their own risk and agree to fully indemnify Vishay for any damages arising or resulting from such use or sale. Please contact authorized Vishay personnel to obtain written terms and conditions regarding products designed for such applications.

Product names and markings noted herein may be trademarks of their respective owners.