

High Power RF LDMOS Field Effect Transistors 340 W, 1805 – 1880 MHz

Description

The PTFB183404E and PTFB183404F are 340-watt LDMOS FETs intended for use in multi-standard cellular power amplifier applications in the 1805 to 1880 MHz frequency band. Features include input and output matching, high gain and thermally-enhanced package with slotted and earless flanges. Manufactured with Infineon's advanced LDMOS process, these devices provide excellent thermal performance and superior reliability.

PTFB183404E
 Package H-36275-8



PTFB183404F
 Package H-37275-6/2

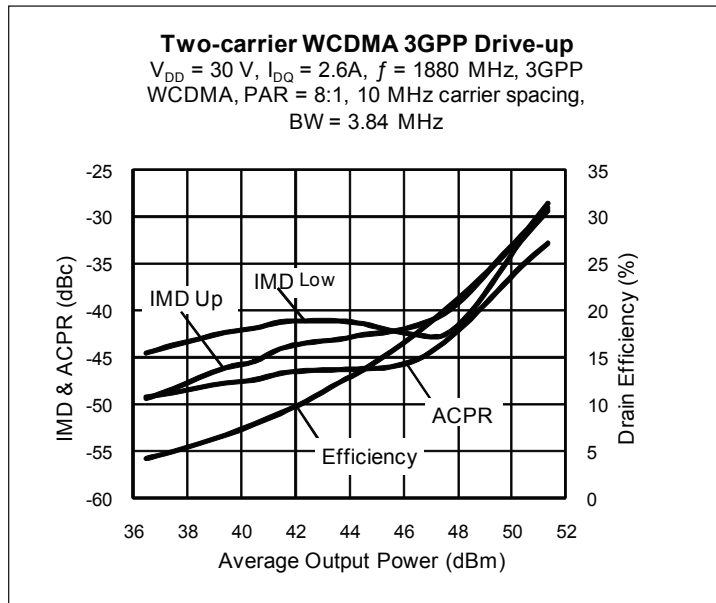

Features

- Broadband internal input and output matching
- Wide video bandwidth
- Typical single-carrier WCDMA performance, 1880 MHz, 30 V
 - Output power = 125 W
 - Efficiency = 31%
 - Gain = 17 dB
 - PAR = 5.5 dB @ 0.01% CCDF probability
 - ACPR @ 5 MHz = -37 dBc
- Increased negative gate-source voltage range for improved performance in Doherty amplifiers
- Capable of handling 10:1 VSWR @ 30 V, 340 W (CW) output power
- Integrated ESD protection
- Excellent thermal stability
- Pb-free and RoHS compliant

RF Characteristics

Two-carrier WCDMA Measurements (tested in Infineon test fixture)

$V_{DD} = 30\text{ V}$, $I_{DQ} = 2.6\text{ A}$, $P_{OUT} = 80\text{ W}$ average, $f_1 = 1870\text{ MHz}$, $f_2 = 1880\text{ MHz}$, 3GPP signal, channel bandwidth = 3.84 MHz, peak/average = 8 dB @ 0.01% CCDF

Characteristic	Symbol	Min	Typ	Max	Unit
Gain	G_{ps}	16	17	—	dB
Drain Efficiency	η_D	24	25.5	—	%
Intermodulation Distortion	IMD	—	-35	-32	dBc

All published data at $T_{CASE} = 25^\circ\text{C}$ unless otherwise indicated

ESD: Electrostatic discharge sensitive device—observe handling precautions!

RF Characteristics (cont.)

Single-carrier WCDMA Performance (not subject to production test – verified by design / characterization in Infineon test fixture)

$V_{DD} = 30\text{ V}$, $I_{DQ} = 2.6\text{ A}$, IQ clipping, channel bandwidth = 3.84 MHz, Input signal PAR = 7.5 dB @ 0.01% CCDF probability

Characteristic	Conditions	Symbol	1805 MHz (Typ)	1842 MHz (Typ)	1880 MHz (Typ)
Gain	$P_{OUT} (AVG) = 49\text{ dBm}$	G_{ps}	17.1	17.3	17.5
	$P_{OUT} (AVG) = 51\text{ dBm}$		17.0	17.15	17.4
Drain Efficiency	$P_{OUT} (AVG) = 49\text{ dBm}$	η_D	25	24.5	24
	$P_{OUT} (AVG) = 51\text{ dBm}$		31	30	30
Output PAR at 0.01%	$P_{OUT} (AVG) = 49\text{ dBm}$	dB	6.5	6.5	6.5
	$P_{OUT} (AVG) = 51\text{ dBm}$		5.5	5.5	5.5
Adjacent Channel Power Ratio	$P_{OUT} (AVG) = 49\text{ dBm}$	ACPR	-43	-42.5	-41
	$P_{OUT} (AVG) = 51\text{ dBm}$		-36	-35	-34

Two-tone Specifications (not subject to production test – verified by design / characterization in Infineon test fixture)

$V_{DD} = 30\text{ V}$, $I_{DQ} = 2.6\text{ A}$, $P_{OUT} = 310\text{ W PEP}$, $f = 1880\text{ MHz}$, tone spacing = 1 MHz

Characteristic	Symbol	Min	Typ	Max	Unit
Gain	G_{ps}	–	17.5	–	dB
Drain Efficiency	η_D	–	35	–	%
Intermodulation Distortion	IMD	–	30	–	dBc

DC Characteristics

Characteristic	Conditions	Symbol	Min	Typ	Max	Unit
Drain-Source Breakdown Voltage	$V_{GS} = 0\text{ V}$, $I_{DS} = 10\text{ mA}$	$V_{(BR)DSS}$	65	–	–	V
Drain Leakage Current	$V_{DS} = 28\text{ V}$, $V_{GS} = 0\text{ V}$	I_{DSS}	–	–	1.0	μA
Drain Leakage Current	$V_{DS} = 63\text{ V}$, $V_{GS} = 0\text{ V}$	I_{DSS}	–	–	10.0	μA
On-State Resistance	$V_{GS} = 10\text{ V}$, $V_{DS} = 0.1\text{ V}$	$R_{DS(on)}$	–	0.05	–	Ω
Operating Gate Voltage	$V_{DS} = 30\text{ V}$, $I_{DQ} = 2.6\text{ A}$	V_{GS}	2.3	2.8	3.3	V
Gate Leakage Current	$V_{GS} = 10\text{ V}$, $V_{DS} = 0\text{ V}$	I_{GSS}	–	–	1.0	μA

Maximum Ratings

Parameter	Symbol	Value	Unit
Drain-Source Voltage	V_{DSS}	65	V
Gate-Source Voltage	V_{GS}	-6 to +10	V
Junction Temperature	T_J	200	°C
Storage Temperature Range	T_{STG}	-40 to +150	°C
Thermal Resistance ($T_{CASE} = 70^{\circ}C, 340 W CW$)	$R_{\theta JC}$	0.2	°C/W

Ordering Information

Type and Version	Package Outline	Package Description	Shipping
PTFB183404E V1	H-36275-8	Ceramic open-cavity, slotted push-pull	Tray
PTFB183404E V1 R250	H-36275-8	Ceramic open-cavity, slotted push-pull	Tape & Reel, 250 pcs
PTFB183404F V2	H-37275-6/2	Ceramic open-cavity, earless push-pull	Tray
PTFB183404F V2 R250	H-37275-6/2	Ceramic open-cavity, earless push-pull	Tape & Reel, 250 pcs

Typical Performance (data taken in a production test fixture)

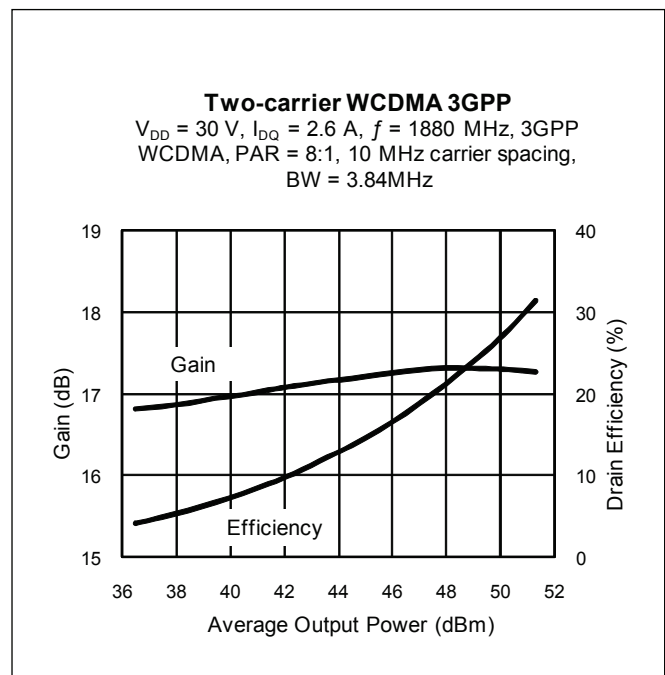
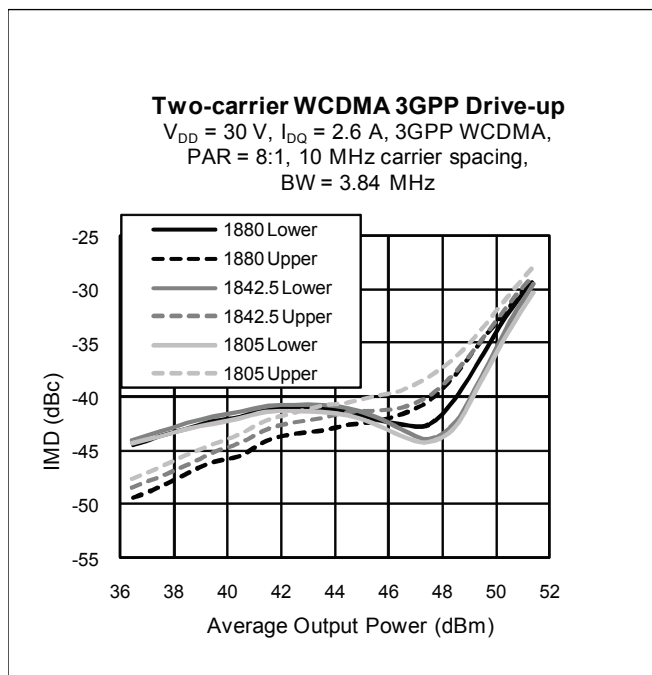

Typical Performance (cont.)

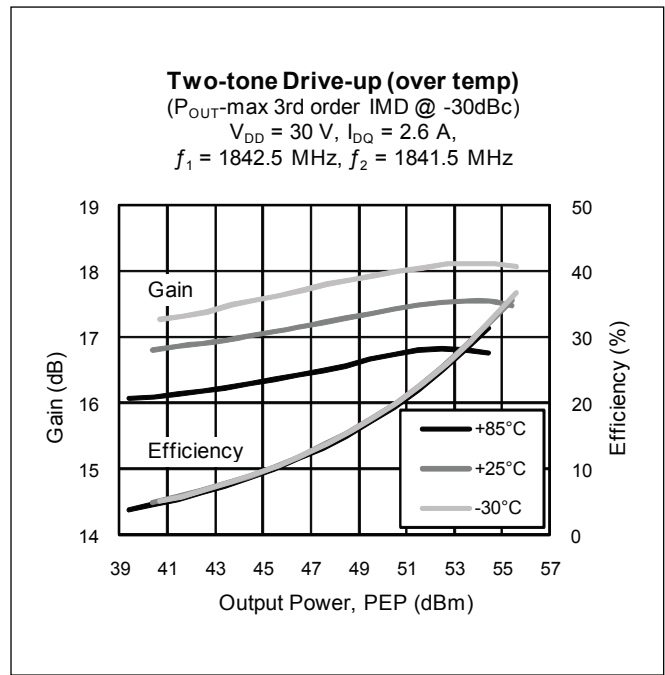
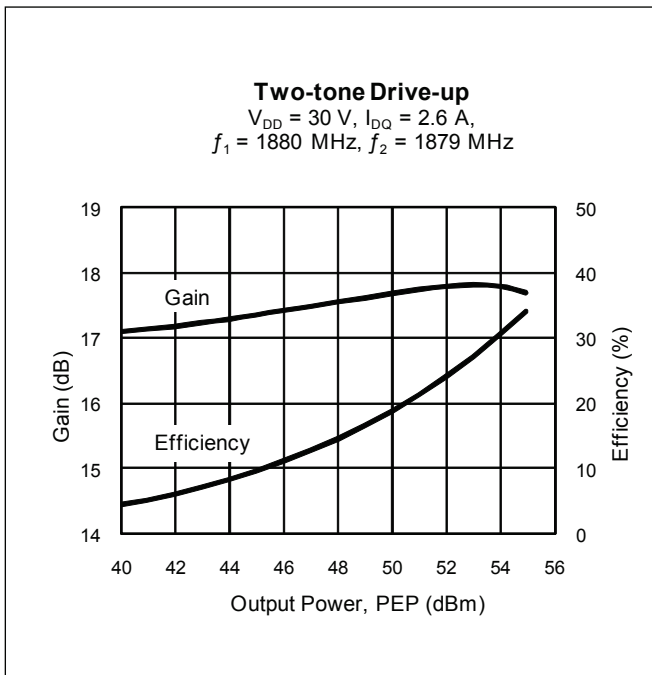
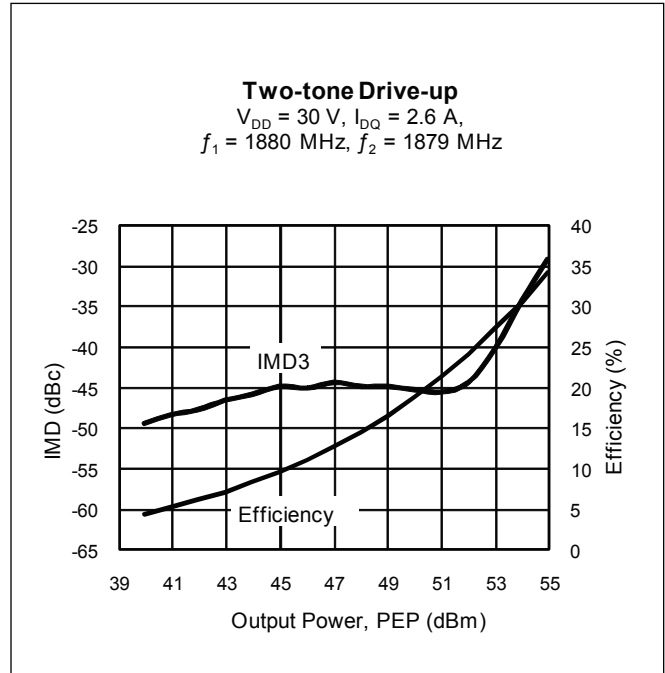
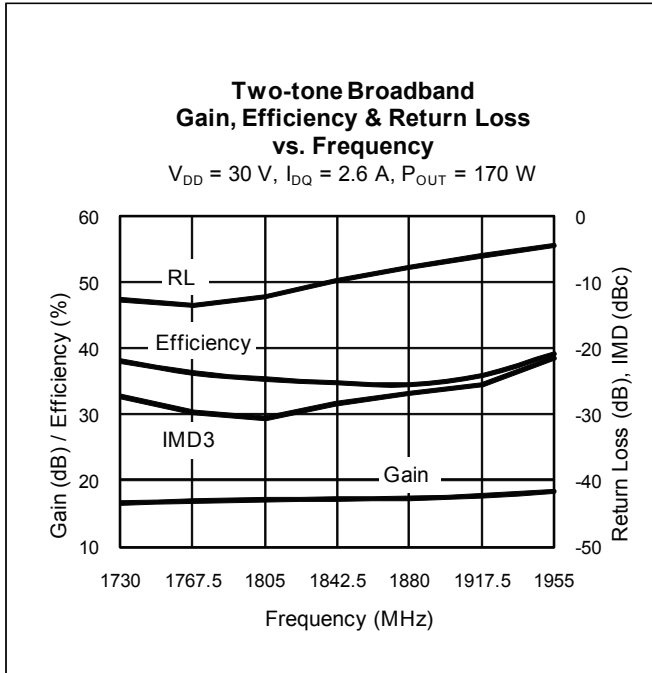

Typical Performance (cont.)

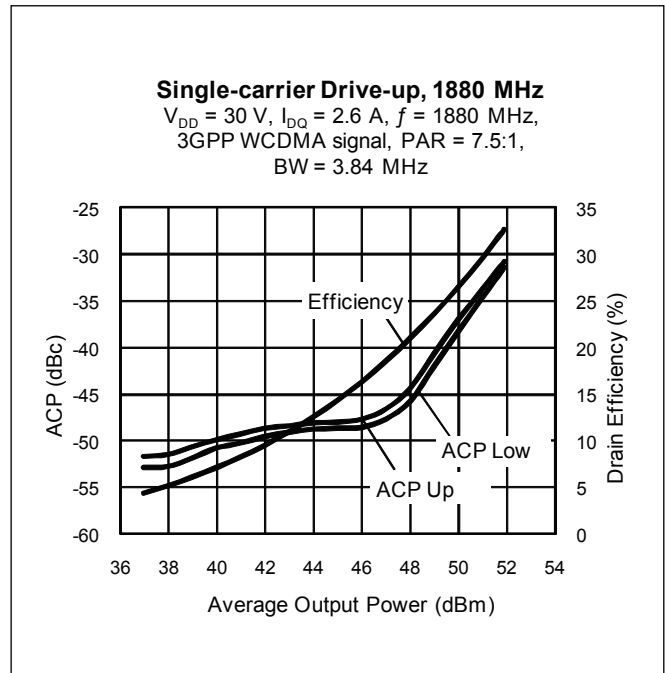
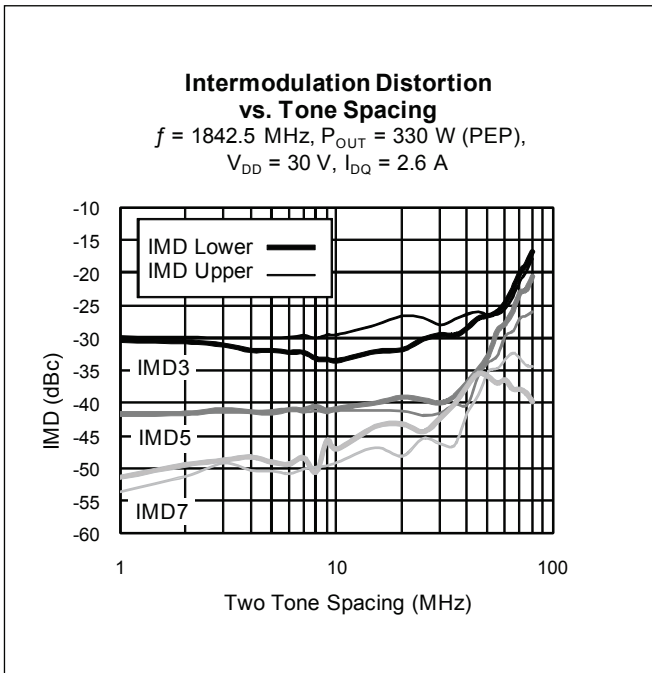
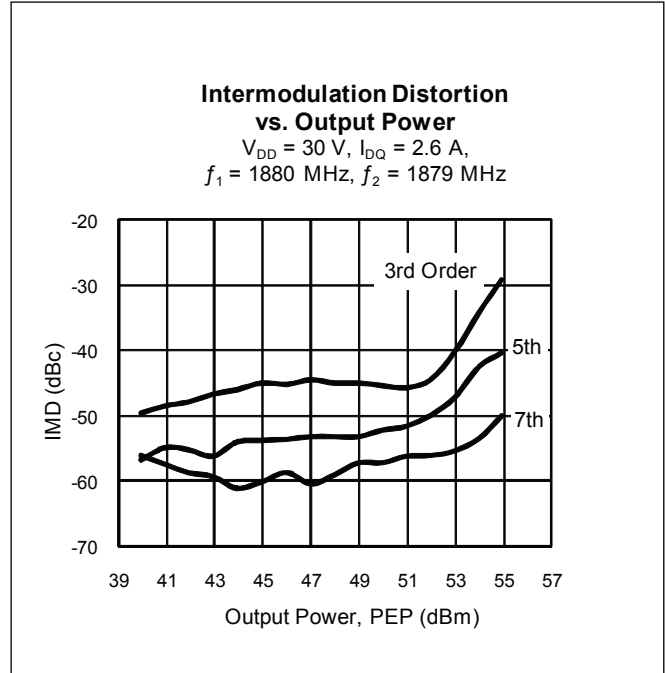
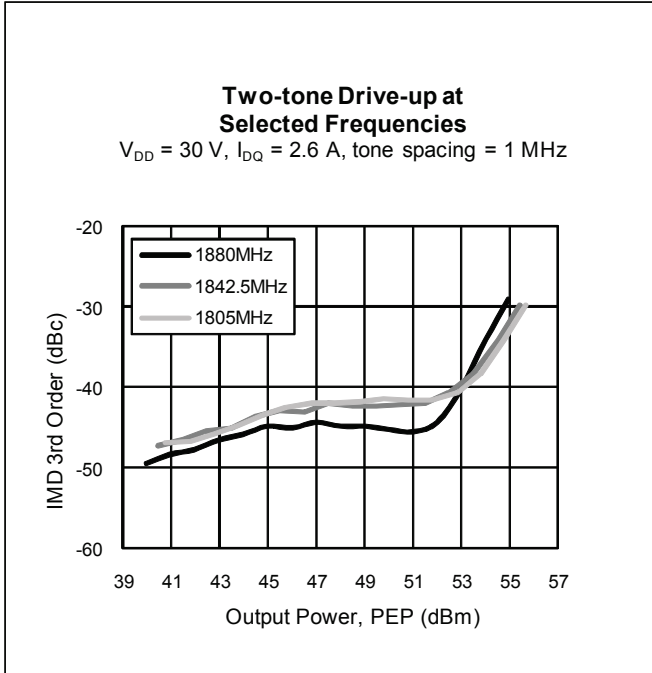

Typical Performance (cont.)

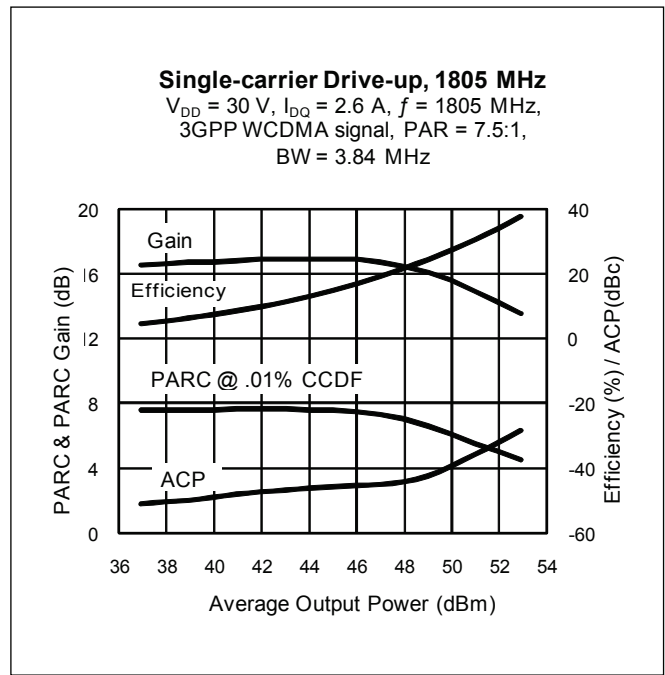
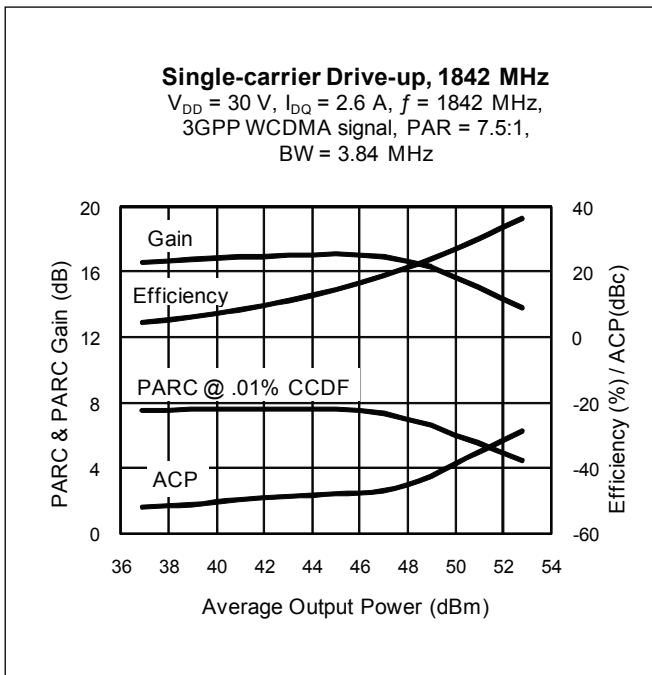
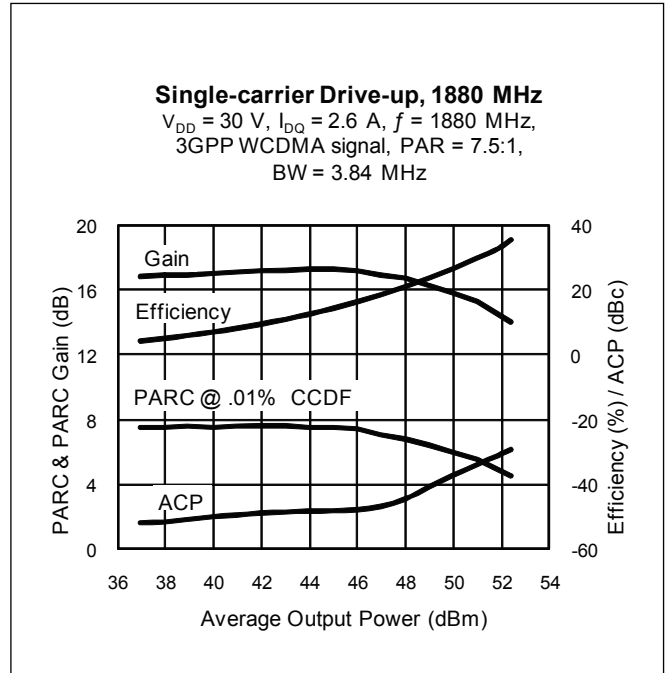
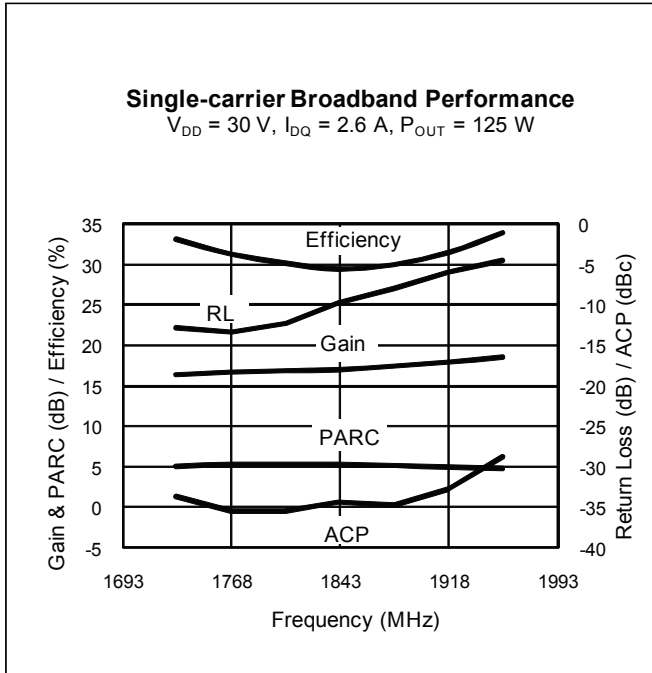

Broadband Circuit Impedance (combined leads)

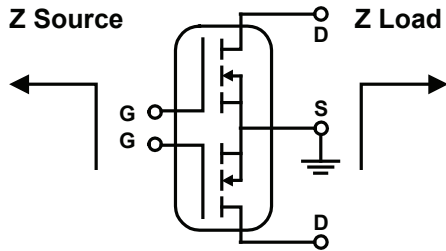

Frequency MHz	Z Source Ω		Z Load Ω	
	R	jX	R	jX
1730	1.86	-4.25	0.55	-2.78
1768	1.77	-4.06	0.54	-2.66
1805	1.68	-3.88	0.53	-7.54
1843	1.61	-3.70	0.52	-2.43
1880	1.56	-3.53	0.51	-2.32
1918	1.51	-3.37	0.51	-2.21
1955	1.47	-3.22	0.5	-2.11

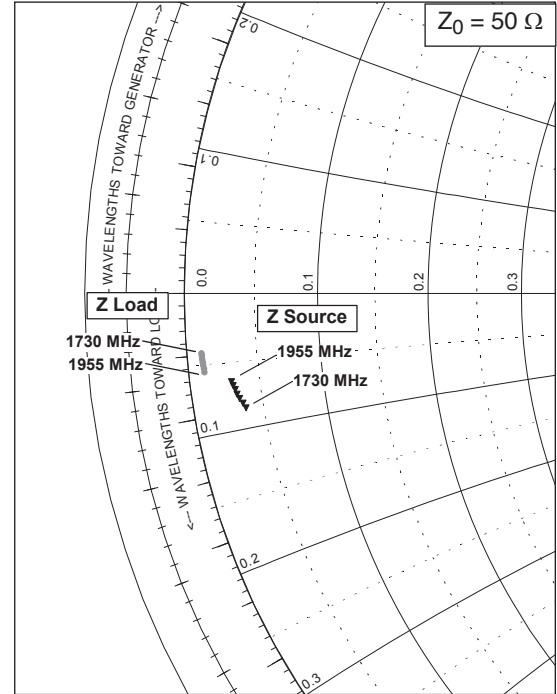

See next page for reference circuit information

Reference Circuit

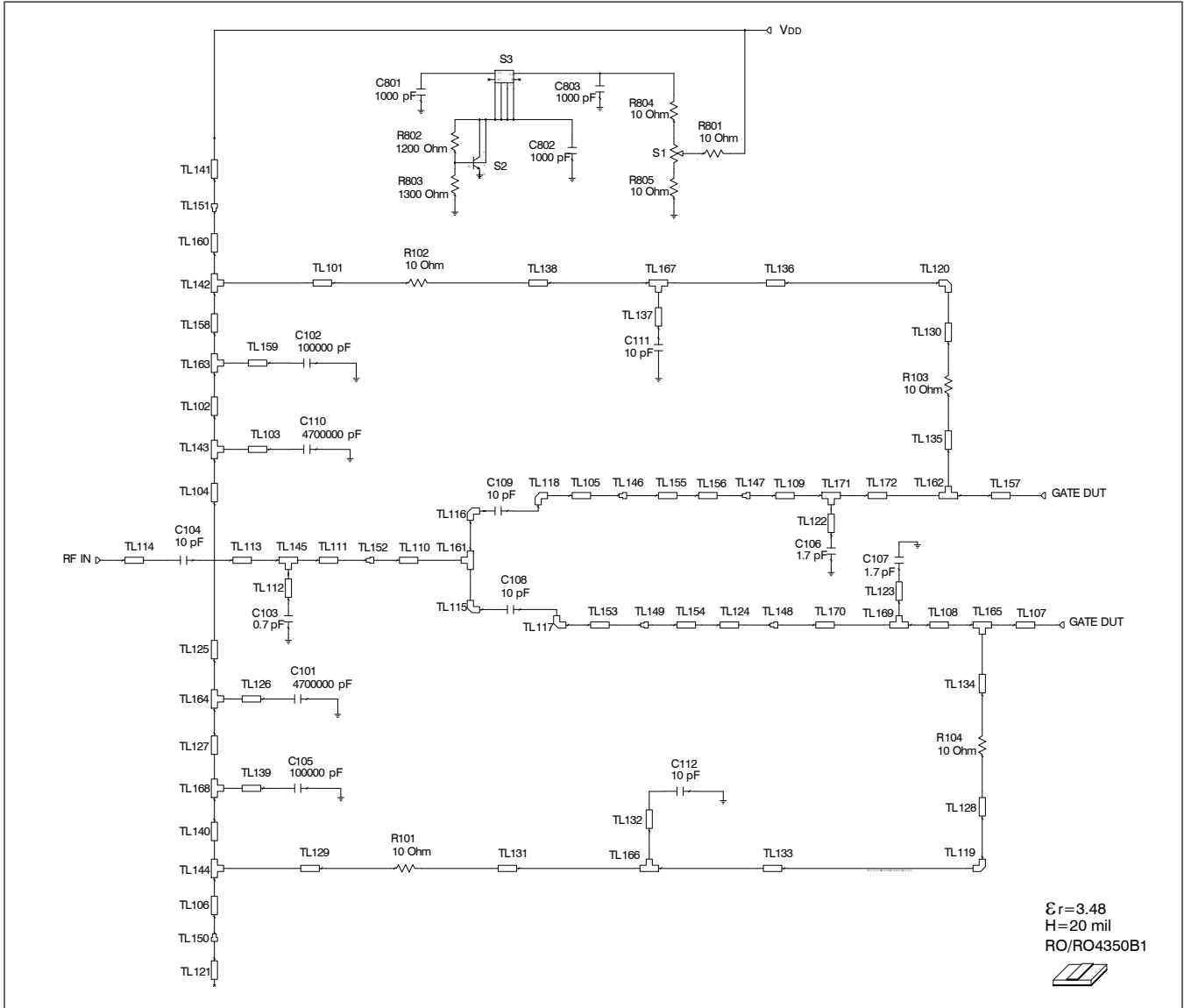

Reference circuit input schematic for $f = 1880 \text{ MHz}$

Reference Circuit (cont.)

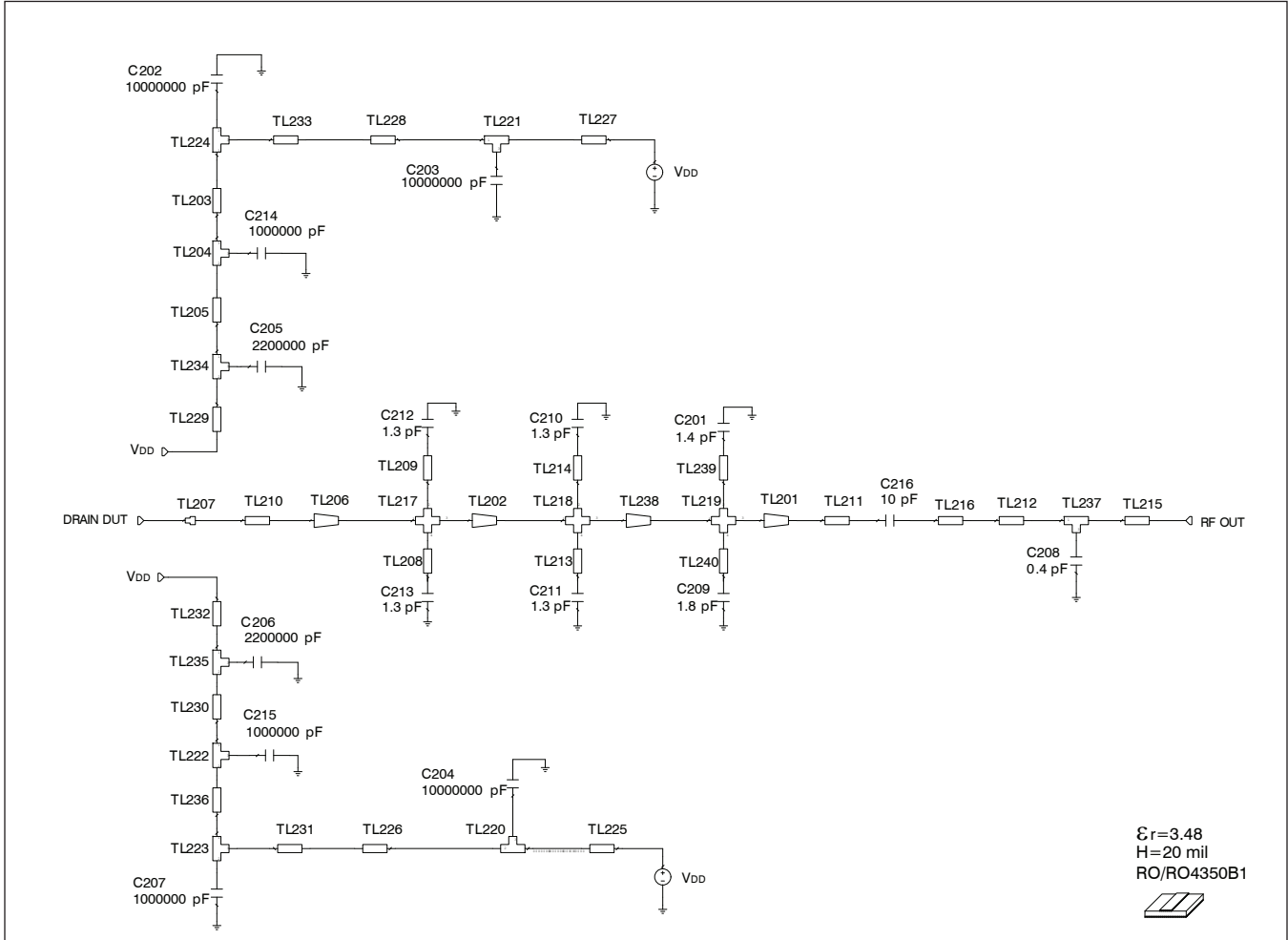

Reference circuit output schematic for $f = 1880 \text{ MHz}$

Reference Circuit (cont.)

Description

DUT	PTFB183404E or PTFB183404F
PCB	0.508 mm [.020"] thick, $\epsilon_r = 3.48$, Rogers 4350, 1 oz. copper

Electrical Characteristics at 1880 MHz

Transmission Line	Electrical Characteristics	Dimensions: mm	Dimensions: mils
Input			
TL101, TL129	0.017 λ , 54.17 Ω	W = 1.016, L = 1.651	W = 40, L = 65
TL102	0.002 λ , 63.89 Ω	W = 0.762, L = 0.203	W = 30, L = 8
TL103, TL139	0.000 λ , 41.75 Ω	W = 1.524, L = 0.025	W = 60, L = 1
TL104	0.208 λ , 63.89 Ω	W = 0.762, L = 20.297	W = 30, L = 799
TL105	0.008 λ , 28.85 Ω	W = 2.540, L = 0.762	W = 100, L = 30
TL106	0.005 λ , 63.89 Ω	W = 0.762, L = 0.508	W = 30, L = 20
TL107, TL157	0.061 λ , 8.03 Ω	W = 11.430, L = 5.359	W = 450, L = 211
TL108, TL172	0.004 λ , 8.03 Ω	W = 11.430, L = 0.338	W = 450, L = 13
TL109, TL170	0.002 λ , 8.03 Ω	W = 11.430, L = 0.196	W = 450, L = 8
TL110	0.022 λ , 32.60 Ω	W = 2.159, L = 2.032	W = 85, L = 80
TL111	0.028 λ , 49.69 Ω	W = 1.168, L = 2.710	W = 46, L = 107
TL112	0.000 λ , 63.89 Ω	W = 0.762, L = 0.025	W = 30, L = 1
TL113	0.016 λ , 49.69 Ω	W = 1.168, L = 1.549	W = 46, L = 61
TL114	0.029 λ , 49.69 Ω	W = 1.168, L = 2.743	W = 46, L = 108
TL115, TL116, TL117, TL118		W = 2.540	W = 100
TL119, TL120		W = 1.016	W = 40
TL121, TL141	0.013 λ , 34.08 Ω	W = 2.032, L = 1.270	W = 80, L = 50
TL122, TL123	0.000 λ , 63.89 Ω	W = 0.762, L = 0.000	W = 30, L = 0
TL124, TL156	0.014 λ , 17.20 Ω	W = 4.826, L = 1.270	W = 190, L = 50
TL125	0.013 λ , 63.89 Ω	W = 0.762, L = 1.270	W = 30, L = 50
TL126, TL139, TL159	0.000 λ , 41.75 Ω	W = 1.524, L = 0.025	W = 60, L = 1
TL127	0.002 λ , 63.89 Ω	W = 0.762, L = 0.203	W = 30, L = 8
TL128, TL130	0.013 λ , 54.17 Ω	W = 1.016, L = 1.262	W = 40, L = 50
TL131, TL138	0.014 λ , 54.17 Ω	W = 1.016, L = 1.397	W = 40, L = 55
TL132, TL137	0.000 λ , 34.08 Ω	W = 2.032, L = 0.025	W = 80, L = 1
TL133, TL136	0.079 λ , 54.17 Ω	W = 1.016, L = 7.620	W = 40, L = 300
TL134, TL135	0.008 λ , 54.17 Ω	W = 1.016, L = 0.762	W = 40, L = 30
TL140	0.015 λ , 63.89 Ω	W = 0.762, L = 1.422	W = 30, L = 56
TL142, TL144	0.010 λ , 63.89 Ω	W1 = 0.762, W2 = 0.762, W3 = 1.016	W1 = 30, W2 = 30, W3 = 40
TL143, TL168	0.016 λ , 63.89 Ω	W1 = 0.762, W2 = 0.762, W3 = 1.524	W1 = 30, W2 = 30, W3 = 60
TL145	0.008 λ , 49.69 Ω	W1 = 1.168, W2 = 1.168, W3 = 0.762	W1 = 46, W2 = 46, W3 = 30
TL146		W1 = 0.003, W2 = 0.005, Offset = 0.000	W1 = 3, W2 = 190, Offset = 10
TL147		W1 = 0.005, W2 = 0.011, Offset = 0.003	W1 = 5, W2 = 450, Offset = 130

table continued on page 11

Reference Circuit (cont.)

Electrical Characteristics at 1880 MHz

Transmission Line	Electrical Characteristics	Dimensions: mm	Dimensions: mils
Input			
TL148		W1 = 0.005, W2 = 0.011, Offset = -0.003	W1 = 5, W2 = 450, Offset = -130
TL149		W1 = 0.003, W2 = 0.005, Offset = 0.000	W1 = 3, W2 = 190, Offset = -10
TL150		W1 = 2.032, W2 = 0.762	W1 = 80, W2 = 30
TL151		W1 = 2.540, W2 = 0.762	W1 = 100, W2 = 30
TL152		W1 = 1.168, W2 = 2.159	W1 = 46, W2 = 85
TL153	0.008 λ , 28.85 Ω	W = 2.540, L = 0.762	W = 100, L = 30
TL154, TL155	0.006 λ , 17.20 Ω	W = 4.826, L = 0.508	W = 190, L = 20
TL158	0.015 λ , 63.89 Ω	W = 0.762, L = 1.422	W = 30, L = 56
TL160	0.004 λ , 63.89 Ω	W = 0.762, L = 0.404	W = 30, L = 16
TL161	0.023 λ , 28.85 Ω	W1 = 2.540, W2 = 2.540, W3 = 2.159	W1 = 100, W2 = 100, W3 = 85
TL162, TL165	0.011 λ , 8.03 Ω	W1 = 11.430, W2 = 11.430, W3 = 1.016	W1 = 450, W2 = 450, W3 = 40
TL163, TL164	0.016 λ , 63.89 Ω	W1 = 0.762, W2 = 0.762, W3 = 1.524	W1 = 30, W2 = 30, W3 = 60
TL166, TL167	0.021 λ , 54.17 Ω	W1 = 1.016, W2 = 1.016, W3 = 2.032	W1 = 40, W2 = 40, W3 = 80
TL169, TL171	0.009 λ , 8.03 Ω	W1 = 11.430, W2 = 11.430, W3 = 0.762	W1 = 450, W2 = 450, W3 = 30

See next page for more reference circuit information

Reference Circuit (cont.)

Electrical Characteristics at 1880 MHz

Transmission Line	Electrical Characteristics	Dimensions: mm	Dimensions: mils
Output			
TL201 (taper)	0.011 λ , 12.30 Ω / 34.72 Ω	W1 = 7.112, W2 = 1.981, L = 1.016	W1 = 280, W2 = 78, L = 40
TL202 (taper)	0.009 λ , 5.88 Ω / 7.95 Ω	W1 = 16.002, W2 = 11.557, L = 0.762	W1 = 630, W2 = 455, L = 30
TL203	0.019 λ , 20.93 Ω	W = 3.810, L = 1.778	W = 150, L = 70
TL204	0.019 λ , 20.93 Ω	W1 = 3.810, W2 = 3.810, W3 = 1.778	W1 = 150, W2 = 150, W3 = 70
TL205, TL230	0.003 λ , 20.93 Ω	W = 3.810, L = 0.254	W = 150, L = 10
TL206 (taper)	0.023 λ , 3.67 Ω / 5.88 Ω	W1 = 26.365, W2 = 16.002, L = 2.032	W1 = 1038, W2 = 630, L = 80
TL207		W1 = 25.400, W2 = 26.365	W1 = 1000, W2 = 1038
TL208, TL209	0.000 λ , 144.35 Ω	W = 0.025, L = 0.025	W = 1, L = 1
TL210	0.055 λ , 3.67 Ω	W = 26.365, L = 4.801	W = 1038, L = 189
TL211	0.044 λ , 34.72 Ω	W = 1.981, L = 4.115	W = 78, L = 162
TL212	0.005 λ , 47.12 Ω	W = 1.270, L = 0.432	W = 50, L = 17
TL213, TL214, TL239, TL240	0.000 λ , 144.35 Ω	W = 0.025, L = 0.025	W = 1, L = 1
TL215	0.066 λ , 47.12 Ω	W = 1.270, L = 6.299	W = 50, L = 248
TL216	0.014 λ , 28.85 Ω	W = 2.540, L = 1.270	W = 100, L = 50
TL217		W1 = 16.002, W2 = 0.025, W3 = 16.002 W4 = 0.025	W1 = 630, W2 = 1, W3 = 630, W4 = 1
TL218		W1 = 11.557, W2 = 0.025, W3 = 11.557 W4 = 0.025	W1 = 455, W2 = 1, W3 = 455, W4 = 1
TL219		W1 = 7.112, W2 = 0.025, W3 = 7.112 W4 = 0.025	W1 = 280, W2 = 1, W3 = 280 W4 = 1
TL220, TL221, TL223, TL224	0.042 λ , 20.93 Ω	W1 = 3.810, W2 = 3.810, W3 = 3.810	W1 = 150, W2 = 150, W3 = 150
TL222	0.019 λ , 20.93 Ω	W1 = 3.810, W2 = 3.810, W3 = 1.778	W1 = 150, W2 = 150, W3 = 70
TL225, TL227	0.023 λ , 20.93 Ω	W = 3.810, L = 2.078	W = 150, L = 82
TL226, TL228	0.066 λ , 20.93 Ω	W = 3.810, L = 6.020	W = 150, L = 237
TL229, TL232	0.028 λ , 20.93 Ω	W = 3.810, L = 2.540	W = 150, L = 100
TL231, TL233	0.097 λ , 20.93 Ω	W = 3.810, L = 8.915	W = 150, L = 351
TL234, TL235	0.019 λ , 20.93 Ω	W1 = 3.810, W2 = 3.810, W3 = 1.778	W1 = 150, W2 = 150, W3 = 70,
TL236	0.019 λ , 20.93 Ω	W = 3.810, L = 1.778	W = 150, L = 70
TL237	0.021 λ , 47.12 Ω	W1 = 1.270, W2 = 1.270, W3 = 2.032	W1 = 50, W2 = 50, W3 = 80
TL238 (taper)	0.009 λ , 7.95 Ω / 12.30 Ω	W1 = 11.557, W2 = 7.112, L = 0.787	W1 = 455, W2 = 280, L = 31

Reference Circuit (cont.)

Circuit Assembly Information

Test Fixture Part No. LTN/PTFB183404EF

Find Gerber files for this test fixture on the Infineon Web site at <http://www.infineon.com/rfpower>

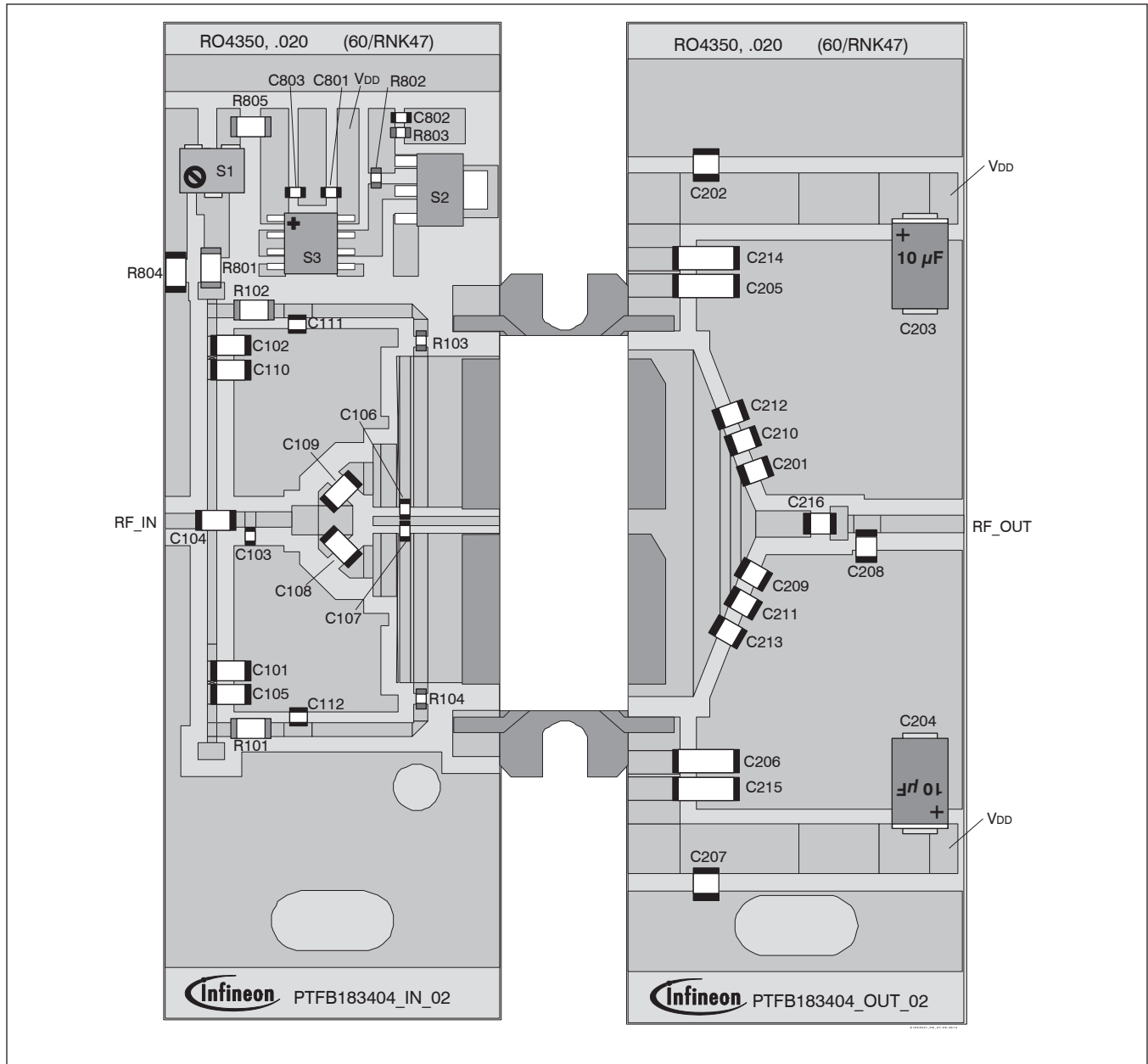

Reference circuit assembly diagram (not to scale)

Reference Circuit (cont.)

Component	Description	Suggested Manufacturer	P/N
Input			
C101, C110	Chip capacitor, 4.7 μ F	Digi-Key	PCS3475CT-ND
C102, C105	Chip capacitor, 0.1 μ F	Digi-Key	PCC104BCT-ND
C103	Chip capacitor, 0.7 pF	ATC	ATC100B0R7BW500XB
C104, C108, C109	Chip capacitor, 10 pF	ATC	ATC100B100JW500XB
C106, C107	Chip capacitor, 1.7 pF	ATC	ATC100A1R7BW150XB
C111, C112	Chip capacitor, 10 pF	ATC	ATC100A100JW500XB
C801, C802, C803	Chip capacitor, 1000 pF	Digi-Key	PCC1772CT-ND
R101, R102, R801, R804, R805	Resistor, 10 Ω	Digi-Key	P10ECT-ND
R103, R104	Resistor, 10 Ω	Digi-Key	P10GCT-ND
R802	Resistor, 1200 Ω	Digi-Key	P1.2KGCT-ND
R803	Resistor, 1300 Ω	Digi-Key	P1.3KGCT-ND
S1	Potentiometer, 2k Ω	Digi-Key	3224W-202ECT-ND
S2	Transistor	Digi-Key	BCP5616TA-ND
S3	Voltage Regulator	Digi-Key	LM7805
Output			
C201	Chip capacitor, 1.4 pF	ATC	ATC100B1R4BW500XB
C202, C207	Chip capacitor, 10 μ F	Digi-Key	587-1818-2-ND
C203, C204	Tantalum capacitor, 10 μ F	Digi-Key	TPSE106K050R0400
C205, C206	Chip capacitor, 2.2 μ F	Digi-Key	445-1447-2-ND
C208	Chip capacitor, 0.4 pF	ATC	ATC100B0R4BW500XB
C209	Chip capacitor, 1.8 pF	ATC	ATC100B1R8BW500XB
C210, C211, C212, C213	Chip capacitor, 1.3 pF	ATC	ATC100B1R3BW500XB
C214, C215	Chip capacitor, 1 μ F	Digi-Key	445-1411-2-ND
C216	Chip capacitor, 10 pF	ATC	ATC100B100JW500XB

Pinout Diagram

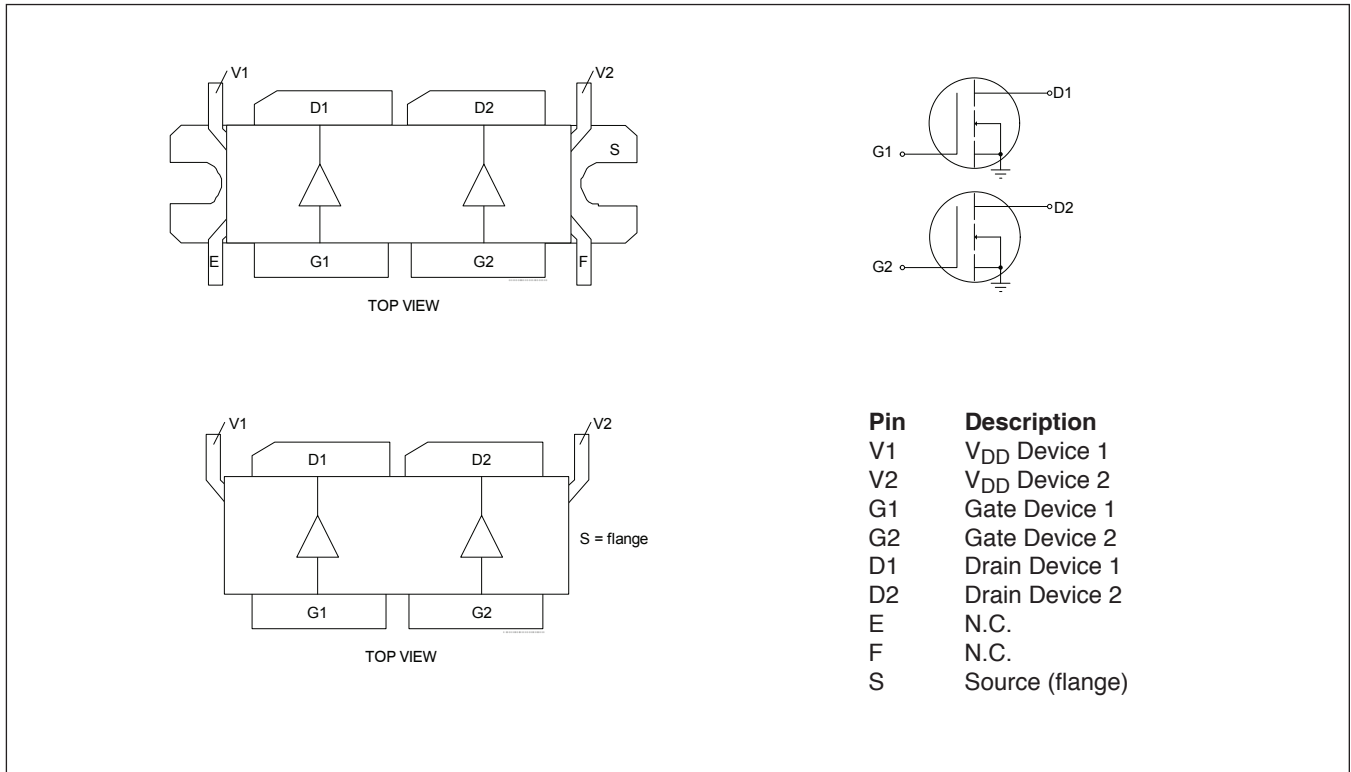

Package Outline Specifications

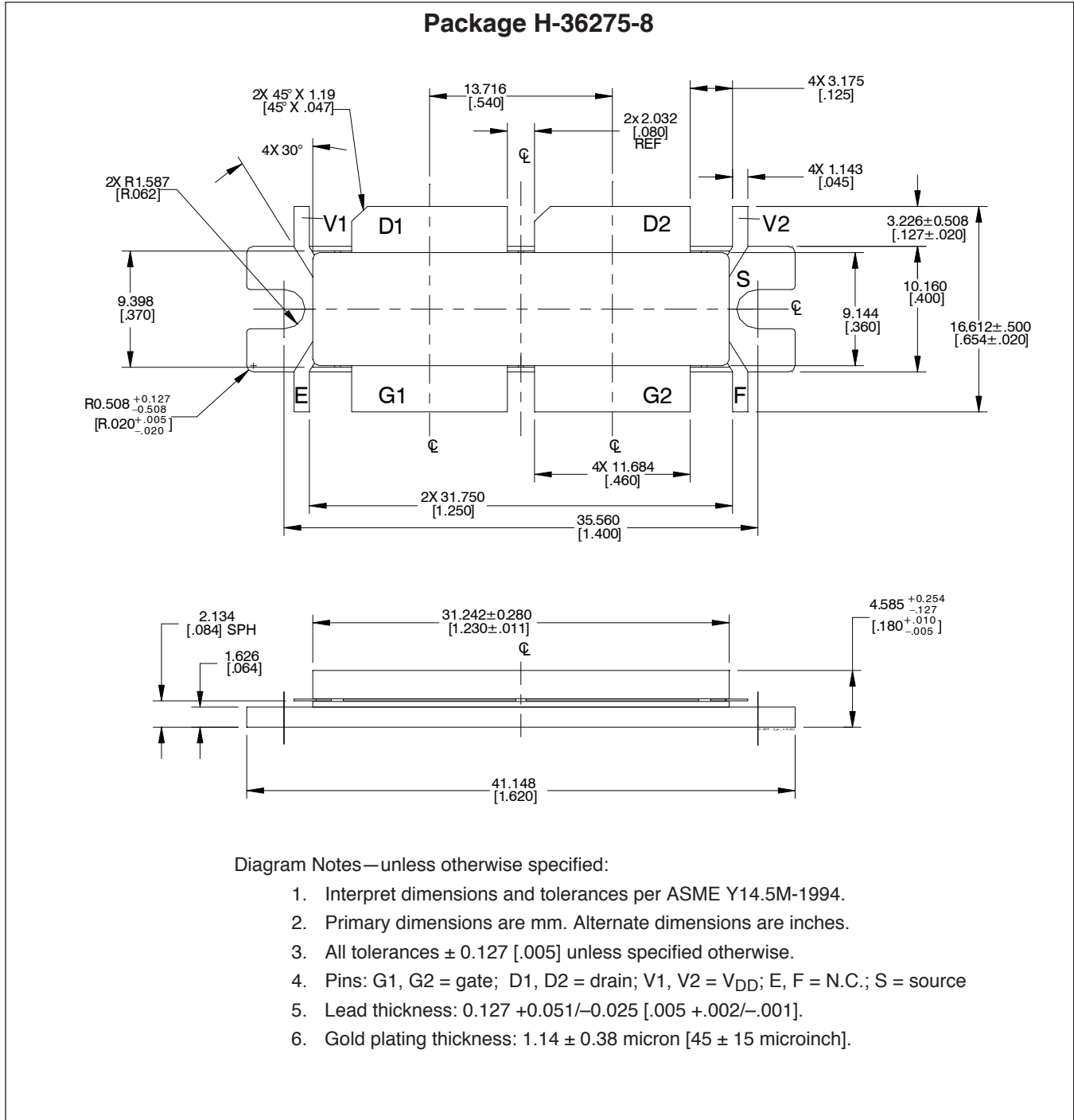

Package Outline Specifications (cont.)

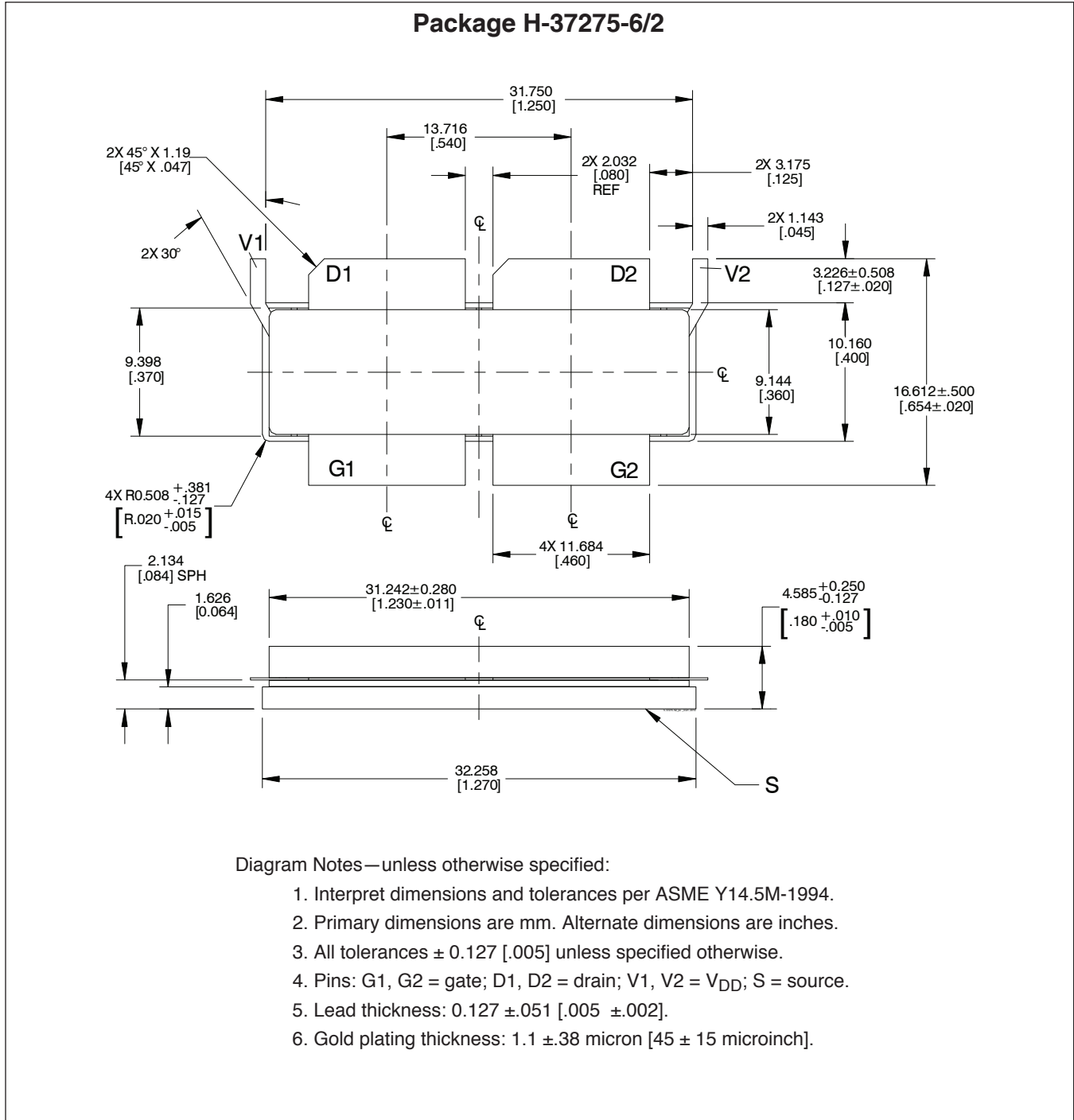

Find the latest and most complete information about products and packaging at the Infineon Internet page <http://www.infineon.com/rfpower>

Revision History: 2010-11-17
Previous Version: 2010-07-23, Data Sheet

Page	Subjects (major changes since last revision)
All	Merge the data sheet to include E and F versions.

We Listen to Your Comments

Any information within this document that you feel is wrong, unclear or missing at all?
 Your feedback will help us to continuously improve the quality of this document.
 Please send your proposal (including a reference to this document) to:

highpowerRF@infineon.com

To request other information, contact us at:
 +1 877 465 3667 (1-877-GO-LDMOS) USA
 or +1 408 776 0600 International

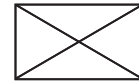

Edition 2010-11-17

Published by
Infineon Technologies AG
81726 Munich, Germany

© 2009 Infineon Technologies AG
All Rights Reserved.

Legal Disclaimer

The information given in this document shall in no event be regarded as a guarantee of conditions or characteristics. With respect to any examples or hints given herein, any typical values stated herein and/or any information regarding the application of the device, Infineon Technologies hereby disclaims any and all warranties and liabilities of any kind, including without limitation, warranties of non-infringement of intellectual property rights of any third party.

Information

For further information on technology, delivery terms and conditions and prices, please contact the nearest Infineon Technologies Office (www.infineon.com/rfpower).

Warnings

Due to technical requirements, components may contain dangerous substances. For information on the types in question, please contact the nearest Infineon Technologies Office.

Infineon Technologies components may be used in life-support devices or systems only with the express written approval of Infineon Technologies, if a failure of such components can reasonably be expected to cause the failure of that life-support device or system or to affect the safety or effectiveness of that device or system. Life support devices or systems are intended to be implanted in the human body or to support and/or maintain and sustain and/or protect human life. If they fail, it is reasonable to assume that the health of the user or other persons may be endangered.