

# DATA SHEET

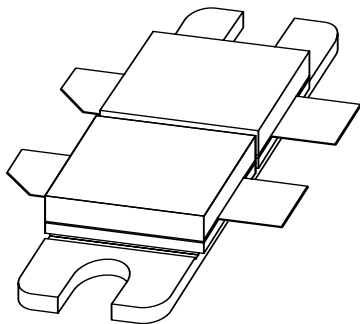

## **BLF548** UHF push-pull power MOS transistor

Product specification  
Supersedes data of Oct 1992

2003 Sep 26

# UHF push-pull power MOS transistor

**BLF548**

## FEATURES

- High power gain
- Easy power control
- Good thermal stability
- Gold metallization ensures excellent reliability
- Designed for broadband operation.

## DESCRIPTION

Dual push-pull silicon N-channel enhancement mode vertical D-MOS transistor designed for communications transmitter applications in the UHF frequency range.

The transistor is encapsulated in a 4-lead, SOT262A2 balanced flange package, with two ceramic caps. The mounting flange provides the common source connection for the transistors.

## PIN CONFIGURATION

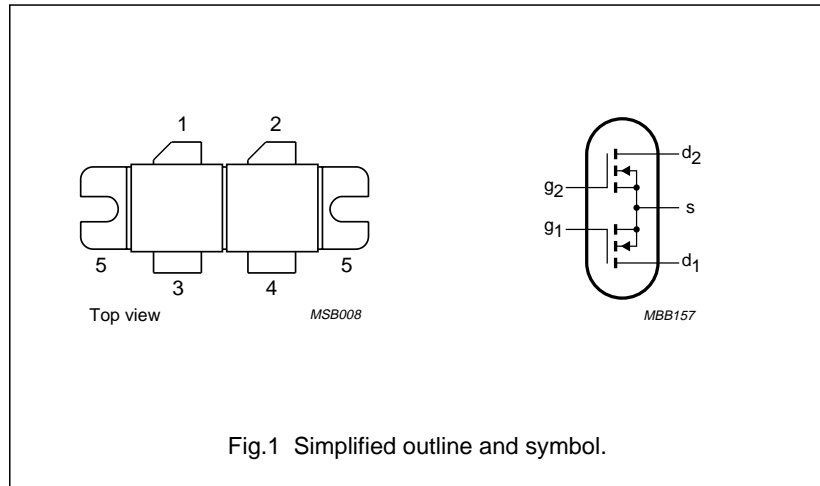

### CAUTION

This product is supplied in anti-static packing to prevent damage caused by electrostatic discharge during transport and handling. For further information, refer to Philips specs.: SNW-EQ-608, SNW-FQ-302A, and SNW-FQ-302B.

## PINNING - SOT262A2

PIN	DESCRIPTION
1	drain 1
2	drain 2
3	gate 1
4	gate 2
5	source

### WARNING

#### Product and environmental safety - toxic materials

This product contains beryllium oxide. The product is entirely safe provided that the BeO discs are not damaged. All persons who handle, use or dispose of this product should be aware of its nature and of the necessary safety precautions. After use, dispose of as chemical or special waste according to the regulations applying at the location of the user. It must never be thrown out with the general or domestic waste.

## QUICK REFERENCE DATA

RF performance at  $T_n = 25\text{ }^\circ\text{C}$  in a push-pull common source test circuit.

MODE OF OPERATION	f (MHz)	$V_{DS}$ (V)	$P_L$ (W)	$G_p$ (dB)	$\eta_D$ (%)
CW, class-B	500	28	150	>10	>50

# UHF push-pull power MOS transistor

BLF548

## LIMITING VALUES

In accordance with the Absolute Maximum System (IEC 60134).

SYMBOL	PARAMETER	CONDITIONS	MIN.	MAX.	UNIT
<b>Per transistor section</b> unless otherwise specified					
$V_{DS}$	drain-source voltage		–	65	V
$V_{GS}$	gate-source voltage		–	$\pm 20$	V
$I_D$	drain current (DC)		–	15	A
$P_{tot}$	total power dissipation	$T_{mb} \leq 25\text{ }^\circ\text{C}$ ; total device; both sections equally loaded	–	330	W
$T_{stg}$	storage temperature		–65	+150	$^\circ\text{C}$
$T_j$	junction temperature		–	200	$^\circ\text{C}$

## THERMAL CHARACTERISTICS

SYMBOL	PARAMETER	CONDITIONS	VALUE	UNIT
$R_{th\ j-mb}$	thermal resistance from junction to mounting base	$T_{mb} = 25\text{ }^\circ\text{C}$ ; $P_{tot} = 330\text{ W}$ ; total device; both sections equally loaded	0.5	K/W
$R_{th\ mb-h}$	thermal resistance from mounting base to heatsink	total device; both sections equally loaded	0.15	K/W

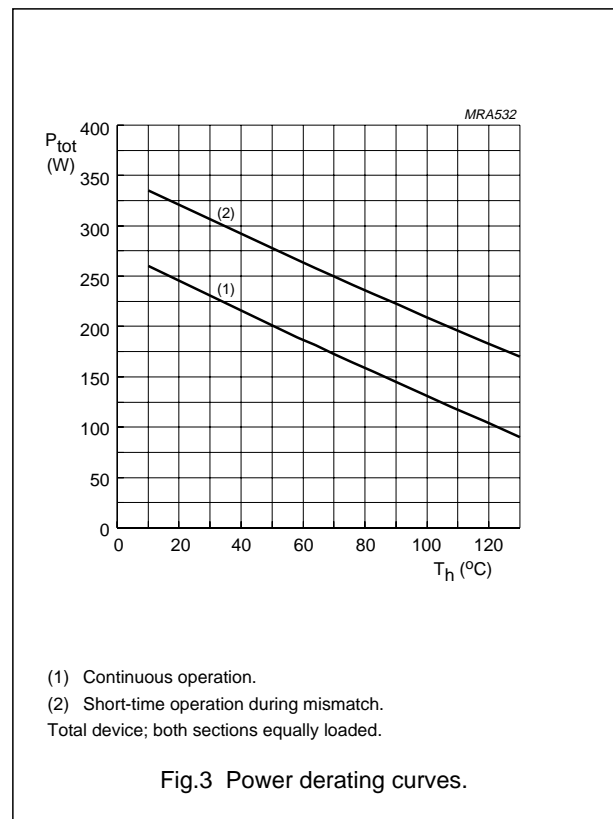
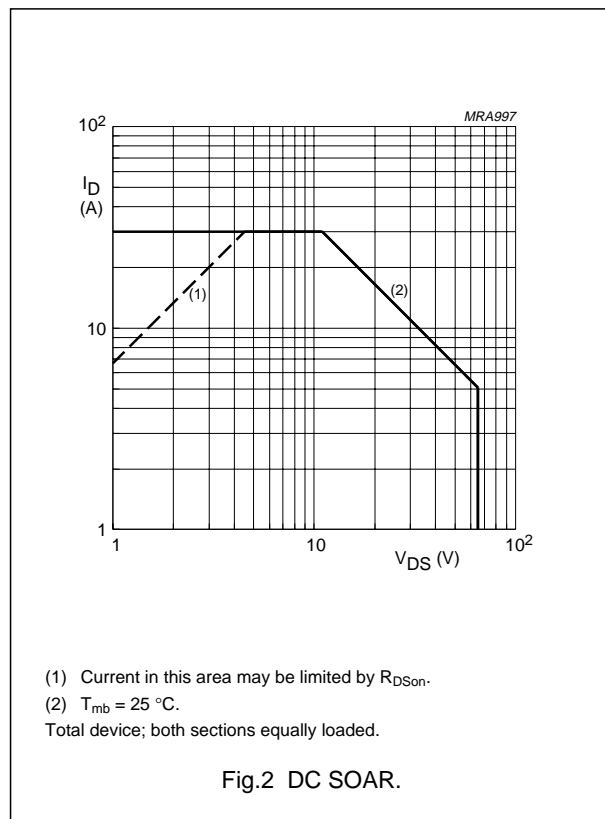

## UHF push-pull power MOS transistor

BLF548

**CHARACTERISTICS** $T_j = 25\text{ °C}$  unless otherwise specified.

SYMBOL	PARAMETER	CONDITIONS	MIN.	TYP.	MAX.	UNIT
<b>Per transistor section</b>						
$V_{(BR)DSS}$	drain-source breakdown voltage	$V_{GS} = 0; I_D = 40\text{ mA}$	65	–	–	V
$I_{DSS}$	drain-source leakage current	$V_{GS} = 0; V_{DS} = 28\text{ V}$	–	–	0.5	mA
$I_{GSS}$	gate-source leakage current	$V_{GS} = \pm 20\text{ V}; V_{DS} = 0$	–	–	1	$\mu\text{A}$
$V_{GSth}$	gate-source threshold voltage	$I_D = 160\text{ mA}; V_{DS} = 10\text{ V}$	2	–	4	V
$g_{fs}$	forward transconductance	$I_D = 4.8\text{ A}; V_{DS} = 10\text{ V}$	2.4	3.5	–	S
$R_{DSon}$	drain-source on-state resistance	$I_D = 4.8\text{ A}; V_{GS} = 10\text{ V}$	–	0.25	0.3	$\Omega$
$I_{DSX}$	on-state drain current	$V_{GS} = 15\text{ V}; V_{DS} = 10\text{ V}$	16	20	–	A
$C_{is}$	input capacitance	$V_{GS} = 0; V_{DS} = 28\text{ V}; f = 1\text{ MHz}$	–	105	–	pF
$C_{os}$	output capacitance	$V_{GS} = 0; V_{DS} = 28\text{ V}; f = 1\text{ MHz}$	–	90	–	pF
$C_{rs}$	feedback capacitance	$V_{GS} = 0; V_{DS} = 28\text{ V}; f = 1\text{ MHz}$	–	25	–	pF

 **$V_{GS}$  group indicator**

GROUP	LIMITS (V)		GROUP	LIMITS (V)	
	MIN.	MAX.		MIN.	MAX.
A	2.0	2.1	O	3.3	3.4
B	2.1	2.2	P	3.4	3.5
C	2.2	2.3	Q	3.5	3.6
D	2.3	2.4	R	3.6	3.7
E	2.4	2.5	S	3.7	3.8
F	2.5	2.6	T	3.8	3.9
G	2.6	2.7	U	3.9	4.0
H	2.7	2.8	V	4.0	4.1
J	2.8	2.9	W	4.1	4.2
K	2.9	3.0	X	4.2	4.3
L	3.0	3.1	Y	4.3	4.4
M	3.1	3.2	Z	4.4	4.5
N	3.2	3.3			

UHF push-pull power MOS transistor

BLF548

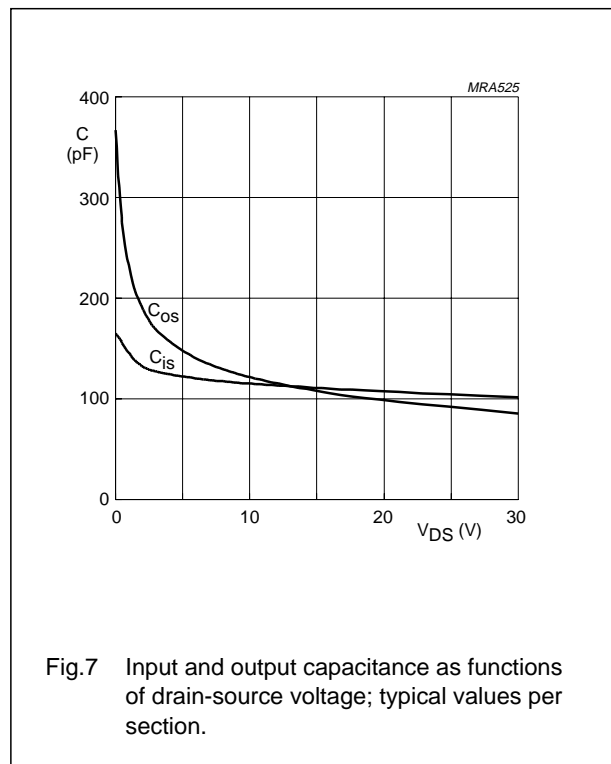
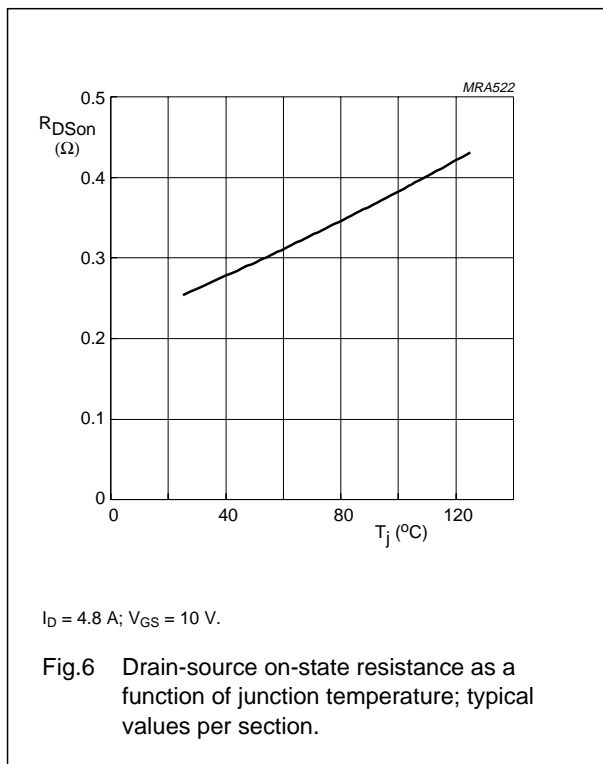
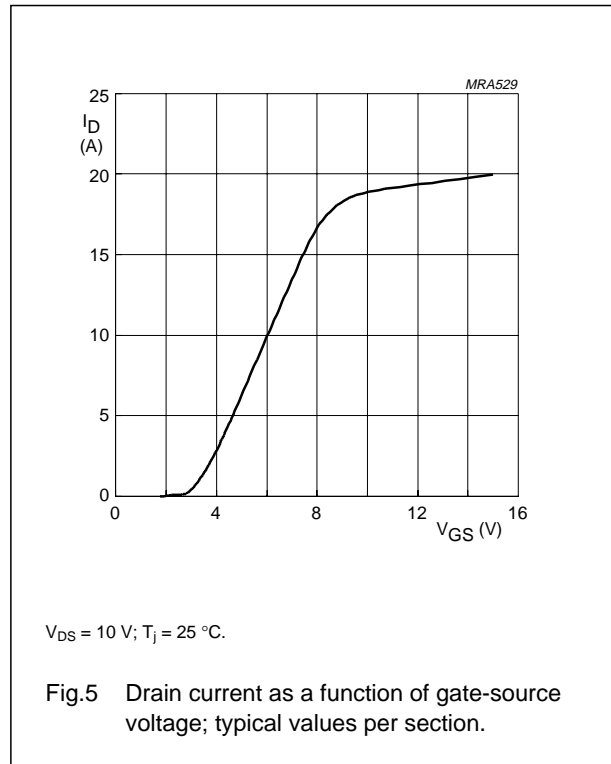
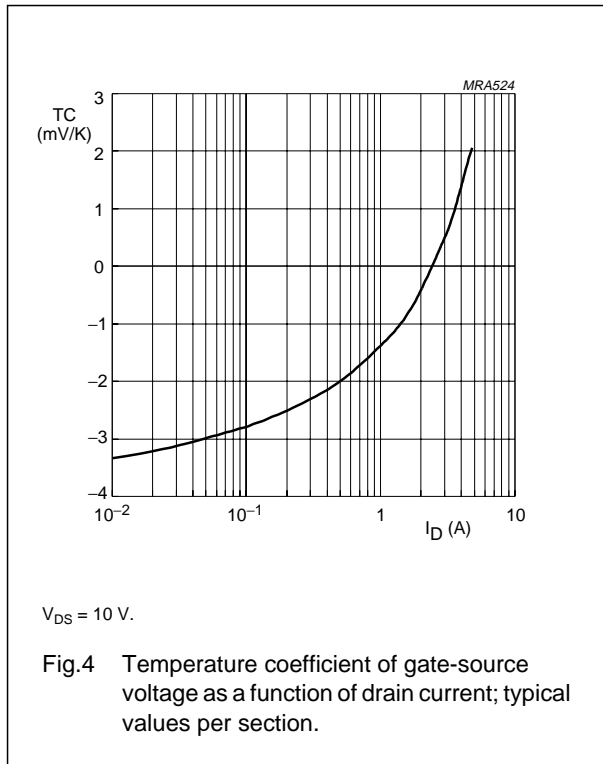

## UHF push-pull power MOS transistor

BLF548

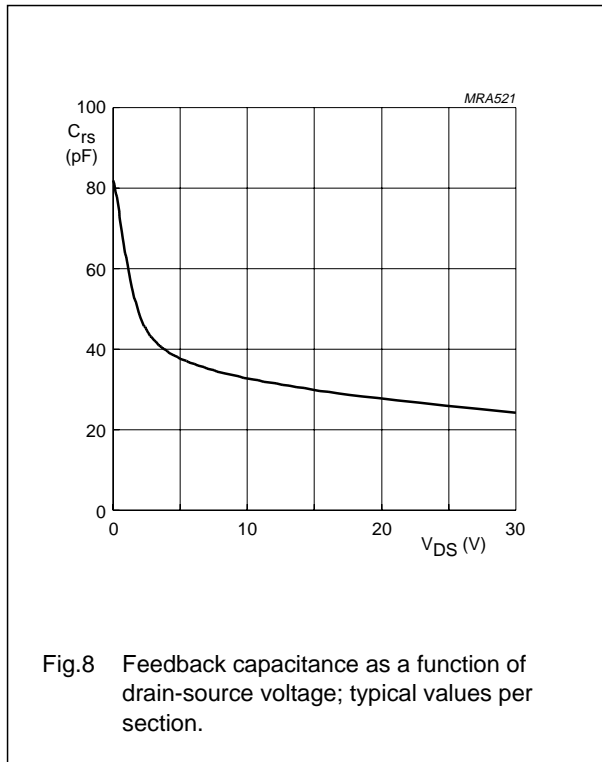

Fig.8 Feedback capacitance as a function of drain-source voltage; typical values per section.

**APPLICATION INFORMATION FOR CLASS-B OPERATION**

$T_h = 25\text{ }^\circ\text{C}$ ;  $R_{th\text{ mb-h}} = 0.15\text{ K/W}$ , unless otherwise specified.

RF performance in a common source, class-B, push-pull test circuit.

MODE OF OPERATION	f (MHz)	$V_{DS}$ (V)	$I_{DQ}$ (mA)	$P_L$ (W)	$G_p$ (dB)	$\eta_D$ (%)
CW, class-B	500	28	2 x 160	150	>10 typ. 11	>50 typ. 55

**Ruggedness in class-B operation**

The BLF548 is capable of withstanding a load mismatch corresponding to VSWR = 10: 1 through all phases under the following conditions:  $V_{DS} = 28\text{ V}$ ;  $f = 500\text{ MHz}$  at rated output power.

UHF push-pull power MOS transistor

BLF548

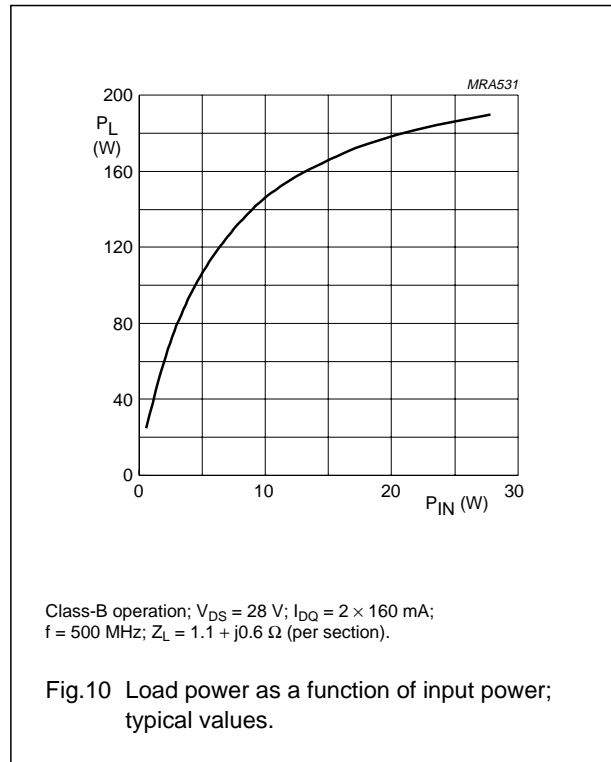
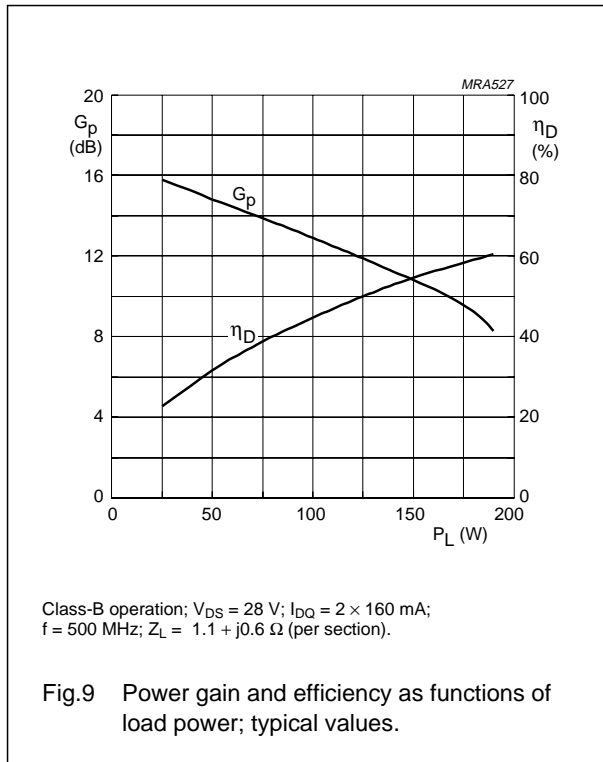

## UHF push-pull power MOS transistor

BLF548

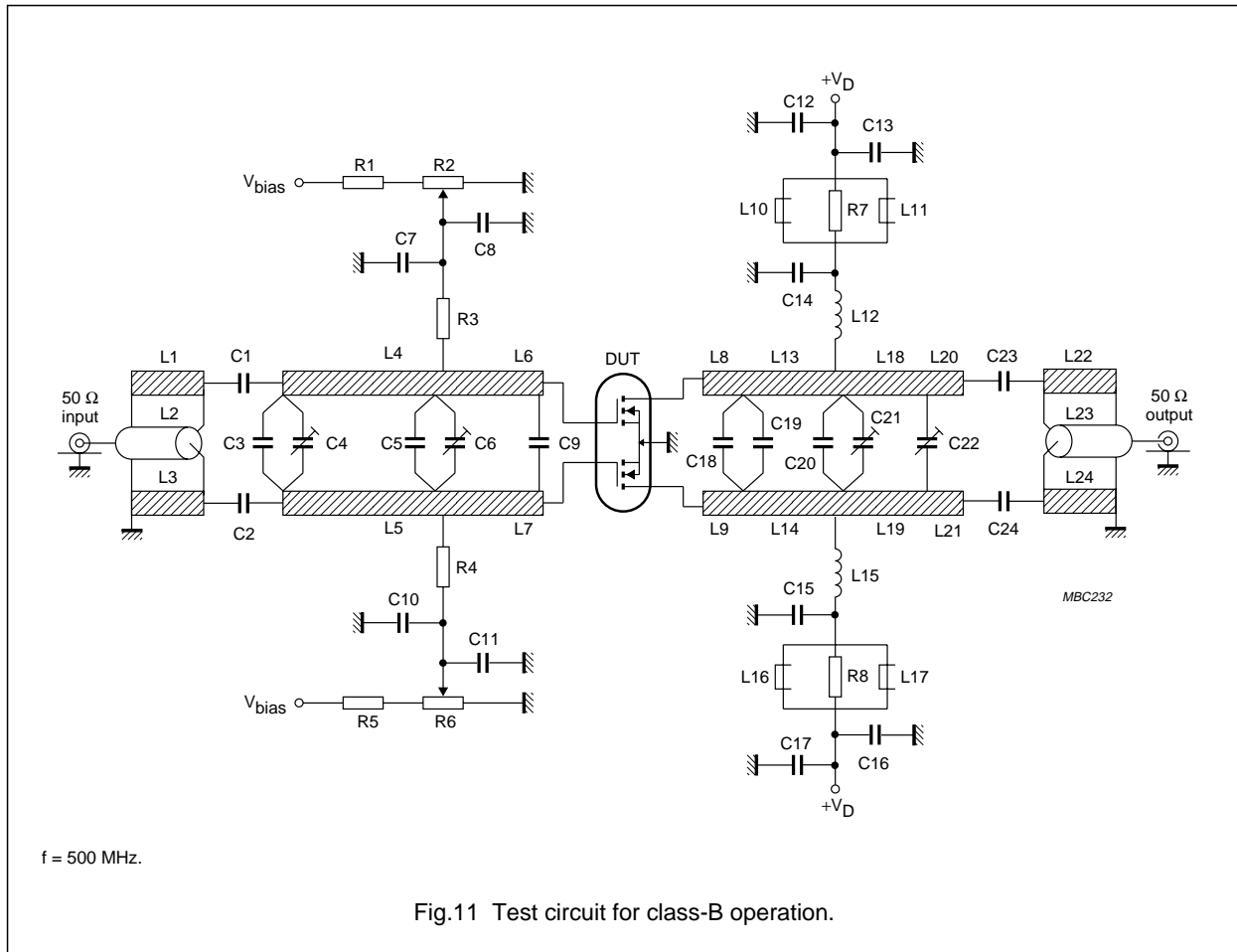

List of components class-B test circuit (see Fig.11)

COMPONENT	DESCRIPTION	VALUE	DIMENSIONS	CATALOGUE NO.
C1, C2	multilayer ceramic chip capacitor; note 1	22 pF		
C3	multilayer ceramic chip capacitor; note 1	16 pF		
C4	film dielectric trimmer	2 to 9 pF		2222 809 09005
C5	multilayer ceramic chip capacitor; note 2	27 pF		
C6, C21, C22	film dielectric trimmer	2 to 18 pF		2222 809 09006
C7, C10, C14, C15	multilayer ceramic chip capacitor; note 1	390 pF		
C8, C11, C12, C17	multilayer ceramic chip capacitor	100 nF		2222 852 47104
C9	multilayer ceramic chip capacitor; note 3	2 × 56 pF in series		



## UHF push-pull power MOS transistor

BLF548

COMPONENT	DESCRIPTION	VALUE	DIMENSIONS	CATALOGUE NO.
C13, C16	electrolytic capacitor	10 $\mu$ F, 63 V		2222 030 38109
C18	multilayer ceramic chip capacitor; note 2	18 pF		
C19	multilayer ceramic chip capacitor; note 2	12 pF		
C20	multilayer ceramic chip capacitor; note 2	8.2 pF		
C23, C24	multilayer ceramic chip capacitor; note 1	30 pF		
L1, L3, L22, L24	stripline; note 4	34.5 $\Omega$	length 66.5 mm width 4 mm	
L2, L23	semi-rigid cable; note 5	50 $\Omega$	length 66.5 mm width 3.6 mm	
L4, L5	stripline; note 4	22.3 $\Omega$	length 35 mm width 7 mm	
L6, L7	stripline; note 4	22.3 $\Omega$	length 10 mm width 7 mm	
L8, L9	stripline; note 4	22.3 $\Omega$	length 5.5 mm width 7 mm	
L10, L11, L16, L17	grade 3B Ferroxcube wideband RF choke			4312 020 36642
L12, L15	1 turn enamelled 1.5 mm copper wire	17 nH	length 5 mm int. dia. 9 mm leads 2 $\times$ 5 mm	
L13, L14	stripline; note 4	22.3 $\Omega$	length 15 mm width 7 mm	
L18, L19	stripline; note 4	22.3 $\Omega$	length 36 mm width 7 mm	
L20, L21	stripline; note 4	22.3 $\Omega$	length 8.5 mm width 7 mm	
R1, R5	0.4 W metal film resistor	24.7 k $\Omega$		2322 151 72473
R2, R6	10 turn potentiometer	5 k $\Omega$		
R3, R4	0.4 W metal film resistor	10.5 k $\Omega$		2322 151 71053
R7, R8	1 W metal film resistor	10 $\Omega$		2322 151 51009

**Notes**

- American Technical Ceramics (ATC) capacitor, type 100B or other capacitor of the same quality.
- American Technical Ceramics (ATC) capacitor, type 175B or other capacitor of the same quality.
- American Technical Ceramics (ATC) capacitor, type 100A or other capacitor of the same quality.
- The striplines are on a double copper-clad printed-circuit board, with PTFE fibre-glass dielectric ( $\epsilon_r = 2.2$ ), thickness 0.79 mm.
- Cables L2 and L23 are soldered to striplines L1 and L22 respectively.

UHF push-pull power MOS transistor

BLF548

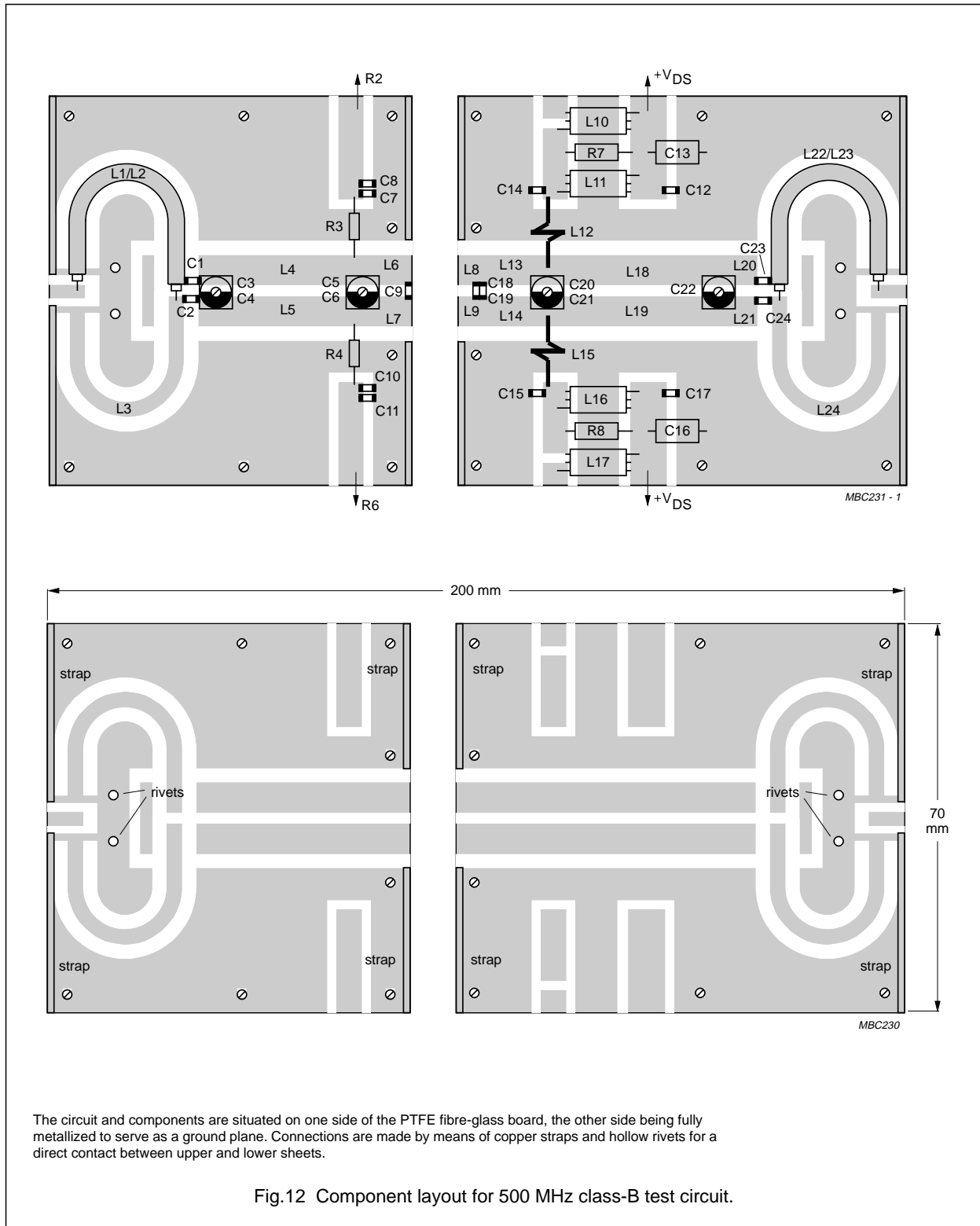
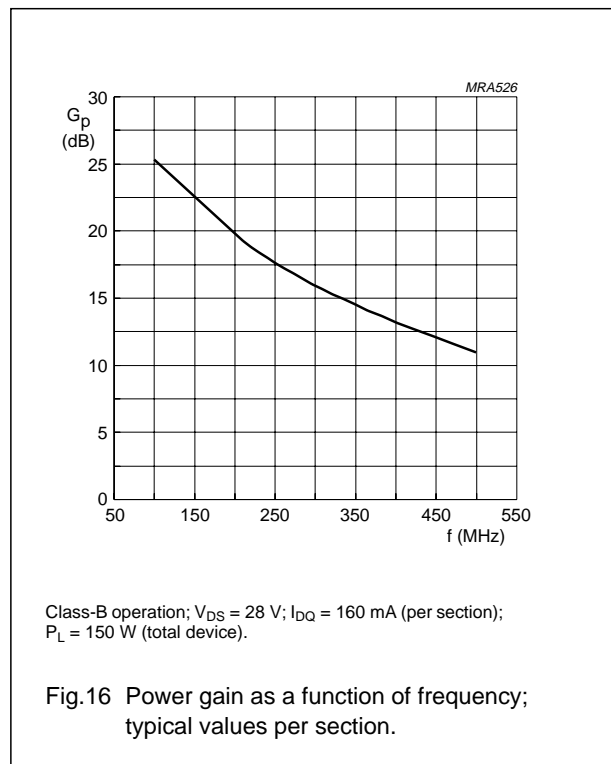
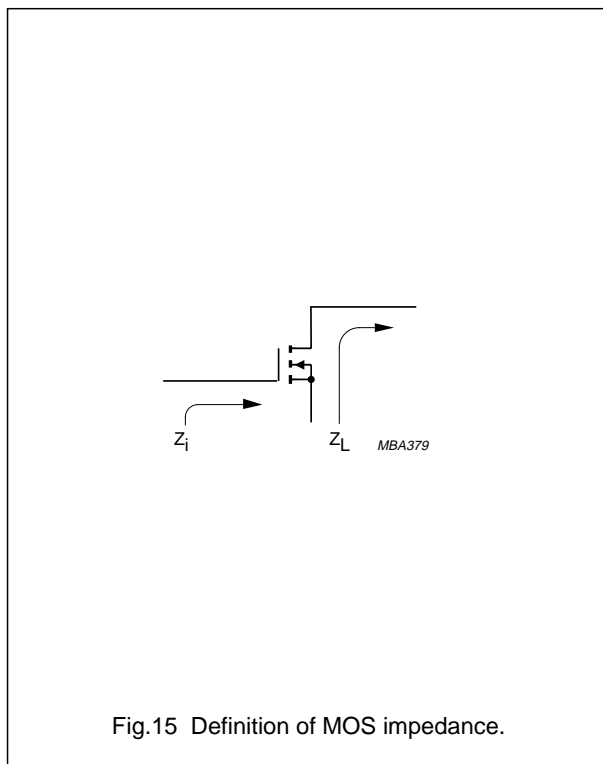
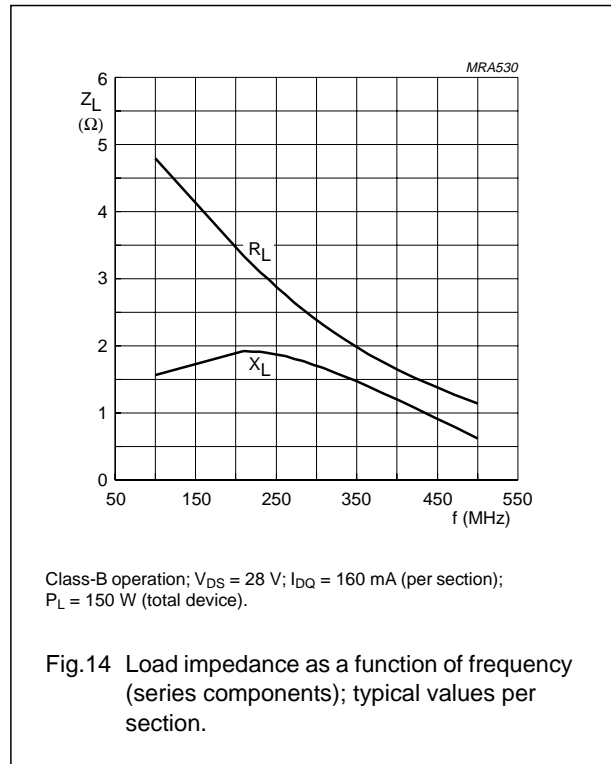
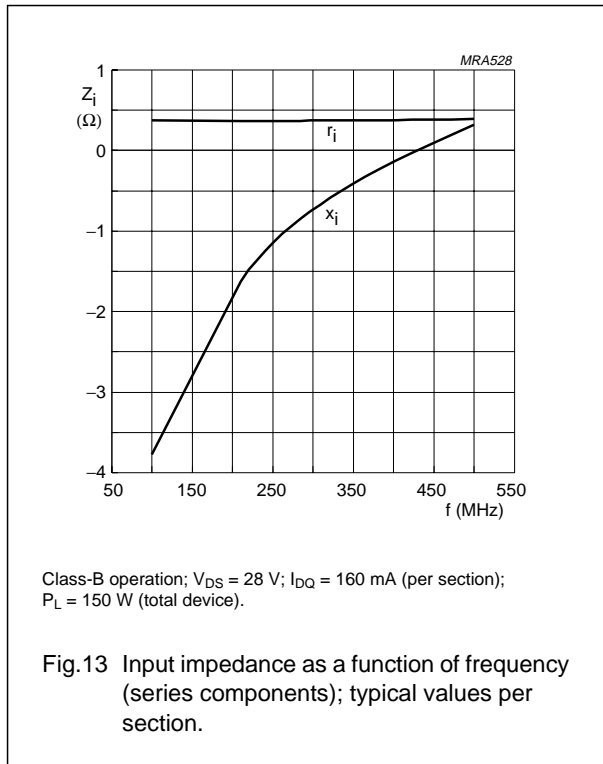

Fig.12 Component layout for 500 MHz class-B test circuit.

UHF push-pull power MOS transistor

BLF548



## UHF push-pull power MOS transistor

BLF548

**BLF548 scattering parameters** $V_{DS} = 28\text{ V}$ ;  $I_D = 40\text{ mA}$ ; note 1

f (MHz)	S <sub>11</sub>		S <sub>21</sub>		S <sub>12</sub>		S <sub>22</sub>	
	S <sub>11</sub>	∠ Φ	S <sub>21</sub>	∠ Φ	S <sub>12</sub>	∠ Φ	S <sub>22</sub>	∠ Φ
5	0.99	-14.0	13.60	171.0	0.02	81.0	0.89	-12.8
10	0.98	-27.6	13.20	162.0	0.04	72.4	0.87	-25.3
20	0.93	-52.0	11.90	146.0	0.07	57.1	0.82	-48.0
30	0.88	-72.0	10.30	134.0	0.09	44.8	0.77	-66.6
40	0.84	-87.7	8.93	124.0	0.10	35.2	0.72	-81.3
50	0.81	-100.0	7.75	116.0	0.11	27.7	0.68	-93.0
60	0.79	-110.0	6.78	110.0	0.12	21.6	0.66	-102.0
70	0.77	-118.0	6.00	104.0	0.12	16.7	0.64	-109.0
80	0.76	-124.0	5.36	99.8	0.12	12.5	0.63	-115.0
90	0.75	-129.0	4.82	95.9	0.12	8.9	0.62	-120.0
100	0.75	-133.0	4.37	92.3	0.13	5.7	0.61	-124.0
125	0.74	-141.0	3.53	84.7	0.13	-1.1	0.61	-131.0
150	0.74	-147.0	2.94	78.3	0.13	-6.6	0.61	-137.0
175	0.74	-151.0	2.50	72.6	0.12	-11.5	0.62	-140.0
200	0.75	-154.0	2.16	67.5	0.12	-15.8	0.64	-143.0
250	0.77	-159.0	1.67	58.4	0.12	-23.3	0.67	-148.0
300	0.78	-163.0	1.33	50.4	0.11	-29.7	0.70	-151.0
350	0.80	-167.0	1.09	43.1	0.10	-35.3	0.73	-154.0
400	0.82	-169.0	0.91	36.6	0.10	-40.3	0.75	-157.0
450	0.84	-172.0	0.77	30.6	0.09	-44.7	0.78	-160.0
500	0.85	-175.0	0.66	25.1	0.08	-48.6	0.80	-162.0
600	0.89	-179.0	0.50	15.6	0.07	-55.2	0.84	-167.0
700	0.90	177.0	0.39	7.5	0.06	-60.4	0.88	-170.0
800	0.92	173.0	0.32	0.6	0.05	-64.3	0.90	-174.0
900	0.93	169.0	0.26	-5.4	0.04	-67.3	0.92	-177.0
1000	0.94	166.0	0.22	-10.8	0.04	-69.2	0.93	-179.0

**Note**

- For more extensive s-parameters see internet:  
<http://www.semiconductors.philips.com/markets/communications/wirelesscommunications/broadcast>

# UHF push-pull power MOS transistor

BLF548

## PACKAGE OUTLINE

Flanged double-ended ceramic package; 2 mounting holes; 4 leads

SOT262A2

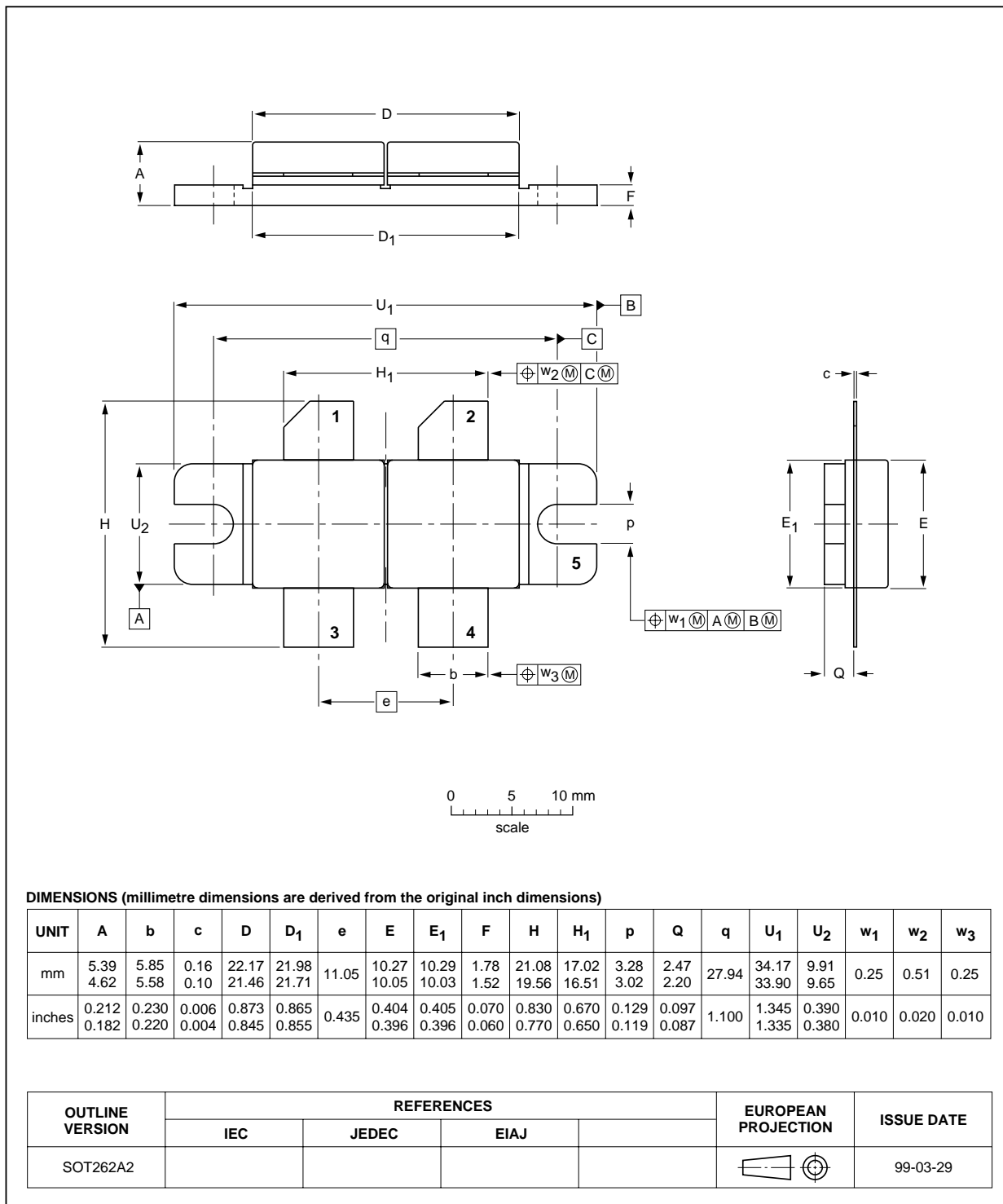

## UHF push-pull power MOS transistor

BLF548

## DATA SHEET STATUS

LEVEL	DATA SHEET STATUS <sup>(1)</sup>	PRODUCT STATUS <sup>(2)(3)</sup>	DEFINITION
I	Objective data	Development	This data sheet contains data from the objective specification for product development. Philips Semiconductors reserves the right to change the specification in any manner without notice.
II	Preliminary data	Qualification	This data sheet contains data from the preliminary specification. Supplementary data will be published at a later date. Philips Semiconductors reserves the right to change the specification without notice, in order to improve the design and supply the best possible product.
III	Product data	Production	This data sheet contains data from the product specification. Philips Semiconductors reserves the right to make changes at any time in order to improve the design, manufacturing and supply. Relevant changes will be communicated via a Customer Product/Process Change Notification (CPCN).

## Notes

1. Please consult the most recently issued data sheet before initiating or completing a design.
2. The product status of the device(s) described in this data sheet may have changed since this data sheet was published. The latest information is available on the Internet at URL <http://www.semiconductors.philips.com>.
3. For data sheets describing multiple type numbers, the highest-level product status determines the data sheet status.

## DEFINITIONS

**Short-form specification** — The data in a short-form specification is extracted from a full data sheet with the same type number and title. For detailed information see the relevant data sheet or data handbook.

**Limiting values definition** — Limiting values given are in accordance with the Absolute Maximum Rating System (IEC 60134). Stress above one or more of the limiting values may cause permanent damage to the device.

These are stress ratings only and operation of the device at these or at any other conditions above those given in the Characteristics sections of the specification is not implied. Exposure to limiting values for extended periods may affect device reliability.

**Application information** — Applications that are described herein for any of these products are for illustrative purposes only. Philips Semiconductors make no representation or warranty that such applications will be suitable for the specified use without further testing or modification.

## DISCLAIMERS

**Life support applications** — These products are not designed for use in life support appliances, devices, or systems where malfunction of these products can reasonably be expected to result in personal injury. Philips Semiconductors customers using or selling these products for use in such applications do so at their own risk and agree to fully indemnify Philips Semiconductors for any damages resulting from such application.

**Right to make changes** — Philips Semiconductors reserves the right to make changes in the products - including circuits, standard cells, and/or software - described or contained herein in order to improve design and/or performance. When the product is in full production (status 'Production'), relevant changes will be communicated via a Customer Product/Process Change Notification (CPCN). Philips Semiconductors assumes no responsibility or liability for the use of any of these products, conveys no licence or title under any patent, copyright, or mask work right to these products, and makes no representations or warranties that these products are free from patent, copyright, or mask work right infringement, unless otherwise specified.

# ***Philips Semiconductors – a worldwide company***

## **Contact information**

For additional information please visit <http://www.semiconductors.philips.com>. Fax: **+31 40 27 24825**

For sales offices addresses send e-mail to: [sales.addresses@www.semiconductors.philips.com](mailto:sales.addresses@www.semiconductors.philips.com).

© Koninklijke Philips Electronics N.V. 2003

SCA75

All rights are reserved. Reproduction in whole or in part is prohibited without the prior written consent of the copyright owner.

The information presented in this document does not form part of any quotation or contract, is believed to be accurate and reliable and may be changed without notice. No liability will be accepted by the publisher for any consequence of its use. Publication thereof does not convey nor imply any license under patent- or other industrial or intellectual property rights.

Printed in The Netherlands

613524/04/pp15

Date of release: 2003 Sep 26

Document order number: 9397 750 11592

*Let's make things better.*

**Philips  
Semiconductors**



**PHILIPS**