

Trisil™ for telecom equipment protection

Features

- Bidirectional crowbar protection
- Voltage range from 8 V to 400 V
- Low capacitance from 20 pF to 45 pF @ 2 V
- Low leakage current: $I_R = 2 \mu\text{A}$ max
- Holding current: $I_H = 150 \text{ mA}$ min
- Repetitive peak pulse current:
 $I_{PP} = 100 \text{ A}$ (10/1000 μs)

Benefits

- Trisils are not subject to ageing and provide a fail safe mode in short circuit for better protection.
- Helps equipment meet main standards such as UL60950, IEC 950 / CSA C22.2 and UL1459.
- Epoxy meets UL94, V0.
- Package is JEDEC registered (DO-214AA).

Complies with the following standards

- GR-1089 Core
- ITU-T-K20/K21
- VDE0433
- VDE0878
- IEC 61000-4-5
- IEC 61000-4-2 level 4
- FCC part 68

Applications

Any sensitive equipment requiring protection against lightning strikes and AC power faults. These devices are dedicated to central office protection as they comply with the most stressful standards. Their low capacitances make them suitable for xDSL.

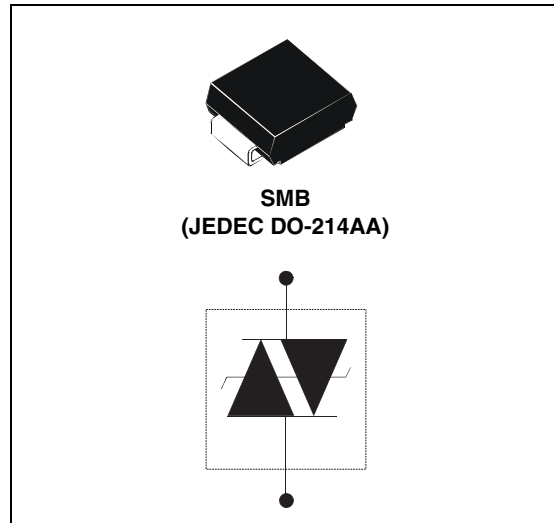

Description

The SMP100LC is a series of low capacitance transient surge arrestors designed for the protection of high data rate communication equipment. The low capacitance of the devices avoids any distortion of the signal and is compatible with digital transmission line cards (xDSL, ISDN...).

SMP100LC series tested and confirmed compatible with Cooper Bussmann Telecom Circuit Protector TCP 1.25A.

The SMP100LC-xxx with the fuse TCP1.25A or TCP2A is compliant with Telcordia GR1089 (lightning and AC power fault tests), ITU-T K20/K21 (lightning and AC power fault tests), TIA/EIA-IS-968 (formerly FCC Part 68 lightning tests), and UL60950 (AC power fault tests). The use of the TCP1.25A allows the SMP100LC-xxx to be safe for the 2nd level (B criteria) AC power fault tests.

TM: Trisil is a trademark of STMicroelectronics

1 Characteristics

Table 1. Compliant with the following standards

Standard	Peak surge voltage (V)	Waveform voltage	Required peak current (A)	Current waveform	Minimum serial resistor to meet standard (Ω)
GR-1089 Core First level	2500	2/10 μ s	500	2/10 μ s	0
	1000	10/1000 μ s	100	10/1000 μ s	0
GR-1089 Core Second level	5000	2/10 μ s	500	2/10 μ s	0
GR-1089 Core Intra-building	1500	2/10 μ s	100	2/10 μ s	0
ITU-T-K20/K21	6000	10/700 μ s	150	5/310 μ s	0
	1500		37.5		0
ITU-T-K20 (IEC61000-4-2)	8000	1/60 ns	ESD contact discharge		0
	15000		ESD air discharge		0
VDE0433	4000	10/700 μ s	100	5/310 μ s	0
	2000		50		0
VDE0878	4000	1.2/50 μ s	100	1/20 μ s	0
	2000		50		0
IEC61000-4-5	4000	10/700 μ s	100	5/310 μ s	0
	4000	1.2/50 μ s	100	8/20 μ s	0
FCC Part 68, lightning surge type A	1500	10/160 μ s	200	10/160 μ s	0
	800	10/560 μ s	100	10/560 μ s	0
FCC Part 68, lightning surge type B	1000	9/720 μ s	25	5/320 μ s	0

Table 2. Absolute ratings ($T_{amb} = 25\text{ }^{\circ}\text{C}$)

Symbol	Parameter	Value	Unit	
I_{PP}	Repetitive peak pulse current (see Figure 1)	10/1000 μ s	100	A
		8/20 μ s	400	
		10/560 μ s	140	
		5/310 μ s	150	
		10/160 μ s	200	
		1/20 μ s	400	
		2/10 μ s	500	
I_{FS}	Fail-safe mode : maximum current ⁽¹⁾	8/20 μ s	5	kA
I_{TSM}	Non repetitive surge peak on-state current (sinusoidal)	t = 0.2 s	24	A
		t = 1 s	15	
		t = 2 s	12	
		t = 15 mn	4	
I^2t	I^2t value for fusing	t = 16.6 ms	20	A^2s
		t = 20 ms	21	
T_{stg}	Storage temperature range	-55 to 150	$^{\circ}\text{C}$	
T_j	Maximum junction temperature			150
T_L	Maximum lead temperature for soldering during 10 s.	260	$^{\circ}\text{C}$	

1. In fail safe mode, the device acts as a short circuit.

Table 3. Thermal Resistances

Symbol	Parameter	Value	Unit
$R_{th(j-a)}$	Junction to ambient (with recommended footprint)	100	°C/W
$R_{th(j-l)}$	Junction to leads	20	°C/W

Table 4. Electrical Characteristics ($T_{amb} = 25\text{ °C}$)

Symbol	Parameter
V_{RM}	Stand-off voltage
V_{BR}	Breakdown voltage
V_{BO}	Breakover voltage
I_{RM}	Leakage current
I_{PP}	Peak pulse current
I_{BO}	Breakover current
I_H	Holding current
V_R	Continuous reverse voltage
I_R	Leakage current at V_R
C	Capacitance

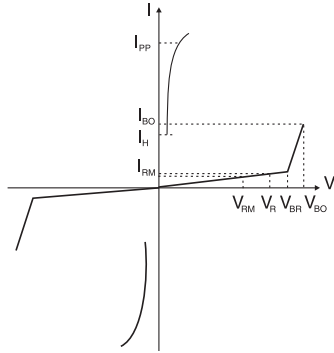

Order code	$I_{RM} @ V_{RM}$		$I_R @ V_R$ (1)		Dynamic V_{BO} (2)	Static $V_{BO} @ I_{BO}$ (3)		I_H (4)	C (5)	C (6)
	max.		max.		max.	max.	max.	min.	typ.	typ.
	μA	V	μA	V	V	V	mA	mA	pF	pF
SMP100LC-8		6		8	25	15		50 (typ.)	NA	75
SMP100LC-25		22		25	40	35			NA	65
SMP100LC-35		32		35	55	55			NA	55
SMP100LC-65		55		65	85	85			45	90
SMP100LC-90		81		90	120	125			40	80
SMP100LC-120		108		120	155	150			35	75
SMP100LC-140		126		140	180	175			30	65
SMP100LC-160	2	144	5	160	205	200	800	150	30	65
SMP100LC-200		180		200	255	250			30	60
SMP100LC-230		207		230	295	285			30	60
SMP100LC-270		243		270	345	335			30	60
SMP100LC-320		290		320	400	390			25	50
SMP100LC-360		325		360	460	450			25	50
SMP100LC-400		360		400	540	530			20	45

- I_R measured at V_R guarantee $V_{BR} \min \geq V_R$
- See [Figure 15: Test circuit 1 for Dynamic \$I_{BO}\$ and \$V_{BO}\$ parameters](#)
- See [Figure 16: Test circuit 2 for \$I_{BO}\$ and \$V_{BO}\$ parameters](#)
- See [Figure 17: Test circuit 3 for dynamic \$I_H\$ parameter](#)
- $V_R = 50\text{ V}$ bias, $V_{RMS} = 1\text{ V}$, $F = 1\text{ MHz}$
- $V_R = 2\text{ V}$ bias, $V_{RMS} = 1\text{ V}$, $F = 1\text{ MHz}$

Figure 1. Pulse waveform

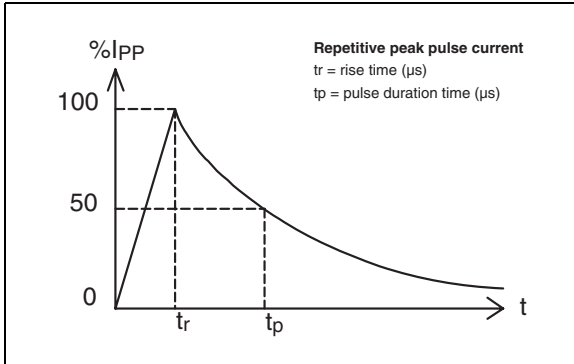

Figure 2. Non repetitive surge peak on-state current versus overload duration

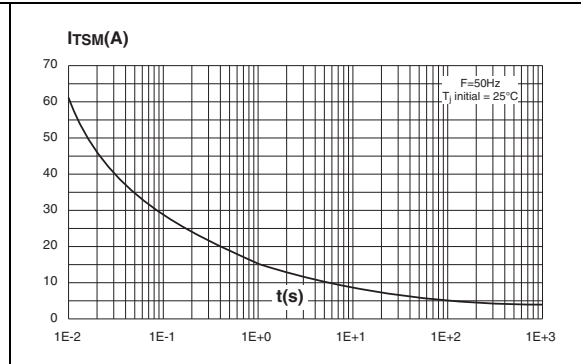

Figure 3. On-state voltage versus on-state current (typical values)

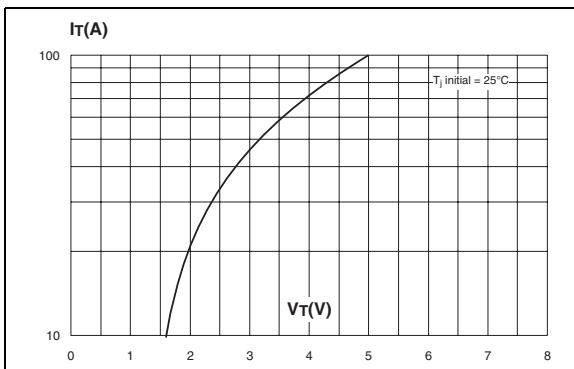

Figure 4. Relative variation of holding current versus junction temperature

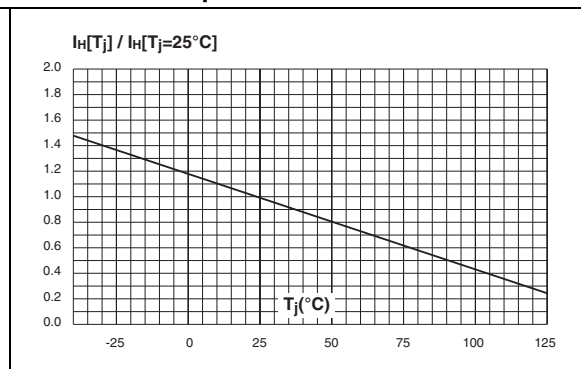

Figure 5. Relative variation of breakover voltage versus junction temperature

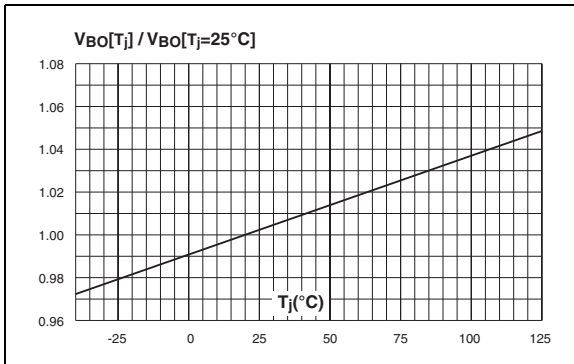

Figure 6. Relative variation of leakage current versus junction temperature (typical values)

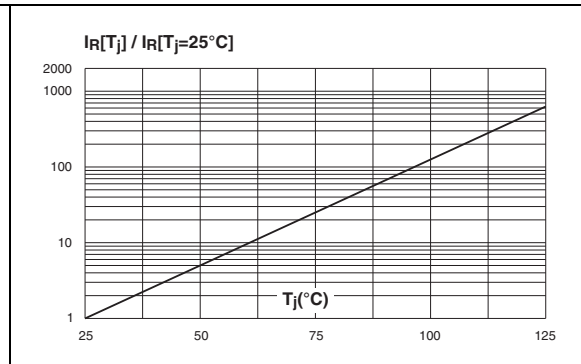

Figure 7. Variation of thermal impedance junction to ambient versus pulse duration

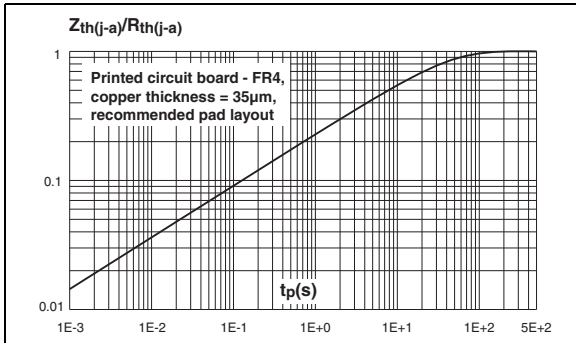
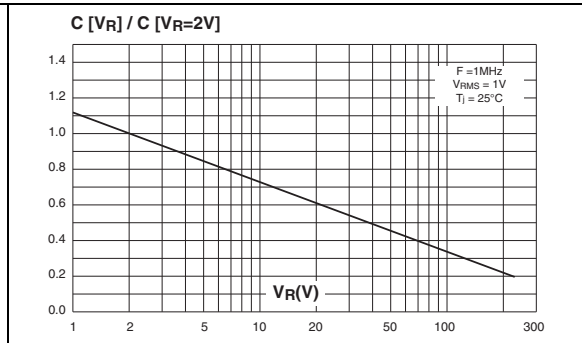

Figure 8. Relative variation of junction capacitance versus reverse voltage applied (typical values)



2 Application information

In wireline applications, analog or digital, both central office and subscriber sides have to be protected. This function is assumed by a combined series / parallel protection stage.

Figure 9. Examples of protection stages for line cards

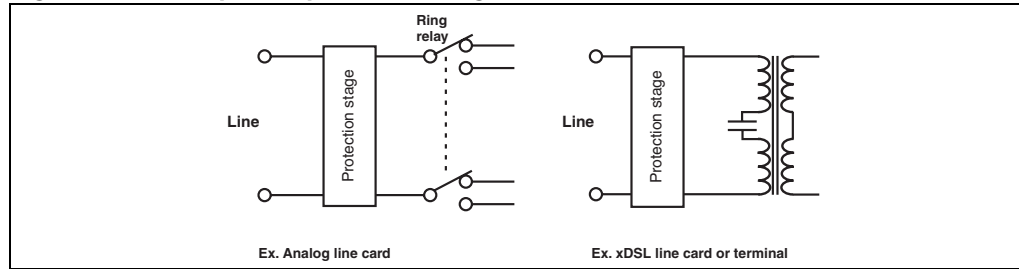

In such a stage, parallel function is assumed by one or several Trisil, and is used to protect against short duration surge (lightning). During this kind of surges the Trisil limits the voltage across the device to be protected at its break over value and then fires. The fuse assumes the series function, and is used to protect the module against long duration or very high current mains disturbances (50/60Hz). It acts by safe circuit opening. Lightning surge and mains disturbance surges are defined by standards like GR1089, FCC part 68, ITU-T K20.

Figure 10. Typical circuits

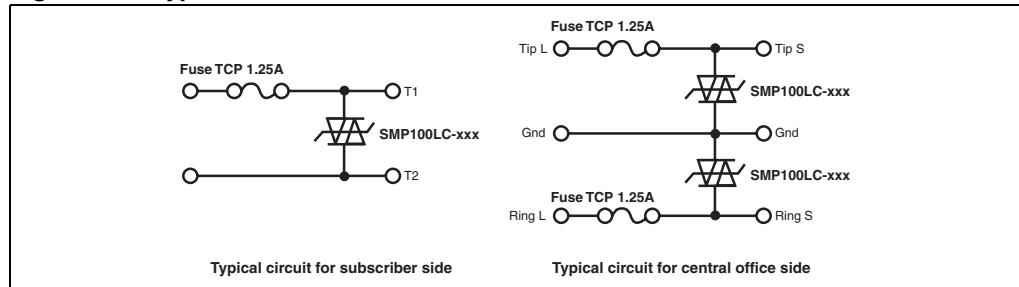
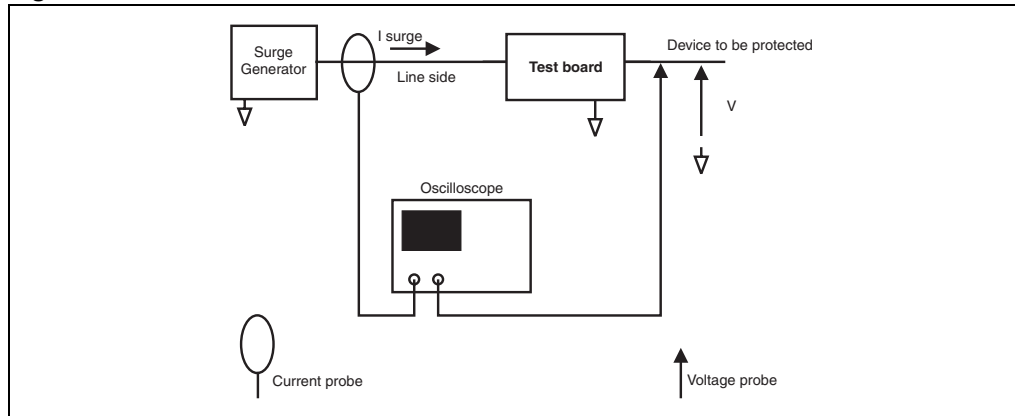
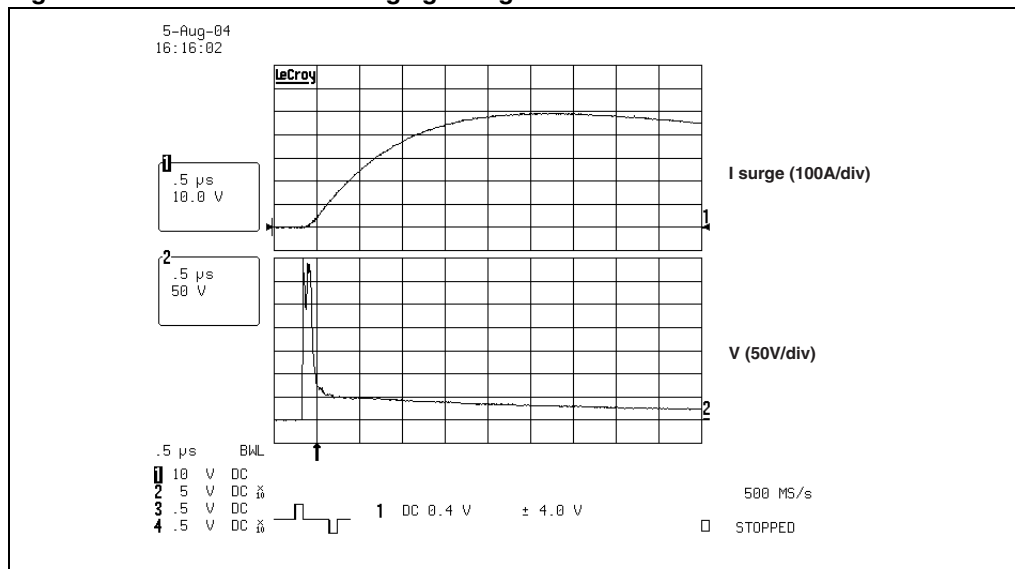

Figure 11. Test method of the board with fuse and Trisil



These topologies, using SMP100LC from ST and TCP1.25A from Cooper Bussmann, have been functionally validated with a Trisil glued on the PCB. Following example was performed with SMP100LC-270 Trisil. For more information, see Application Note AN2064.

Figure 12. Trisil turns on during lightning strike



Test conditions:

2/10 μ s + and - 2.5 and 5 kV, 500 A (10 pulses of each polarity), $T_{amb} = 25\text{ }^{\circ}\text{C}$

Test result:

Fuse and Trisil OK after test in accordance with GR1089 requirements.

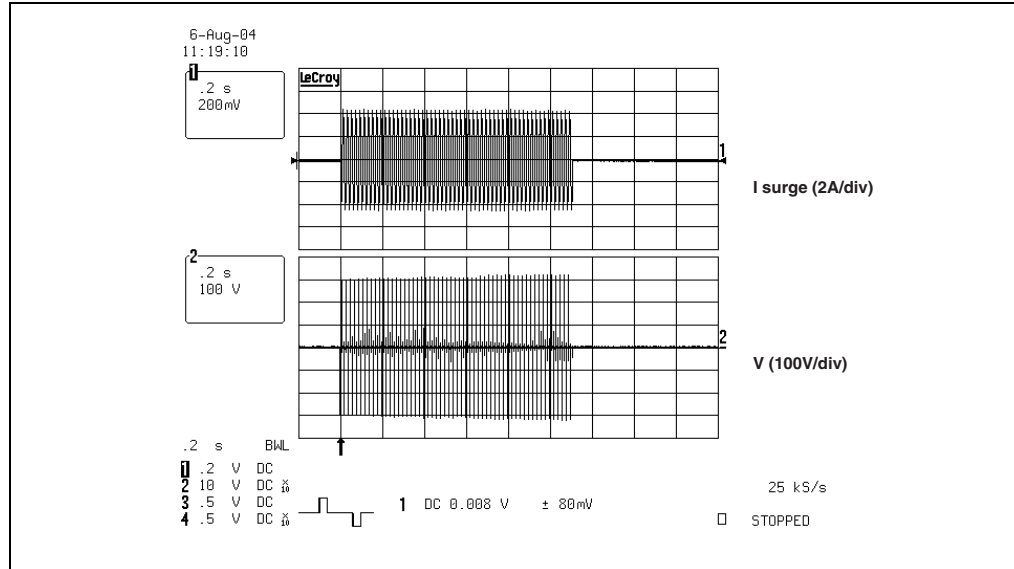
Figure 13. Trisil action while fuse remains operational**Test conditions:**

600 V, 3 A, 1.1 s (first level), $T_{amb} = 25\text{ }^{\circ}\text{C}$

Test result:

Fuse and Trisil OK after test in accordance with GR1089 requirements.

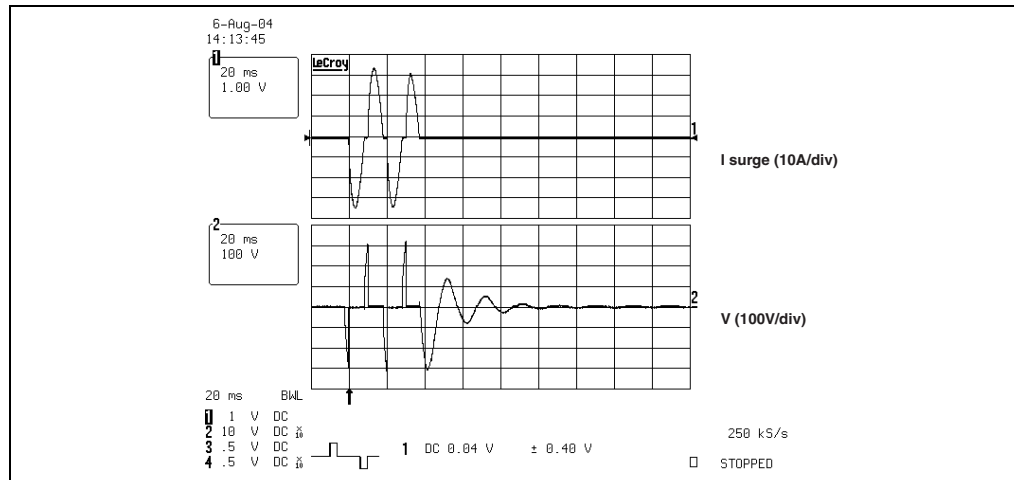
Figure 14. High current AC power test: the fuse acts like a switch by opening the circuit**Test conditions:**

277 V, 25 A (second level), $T_{amb} = 25\text{ }^{\circ}\text{C}$

Test result:

Fuse safely opened and Trisil OK after test in accordance with GR1089 requirements.

Figure 15. Test circuit 1 for Dynamic I_{BO} and V_{BO} parameters

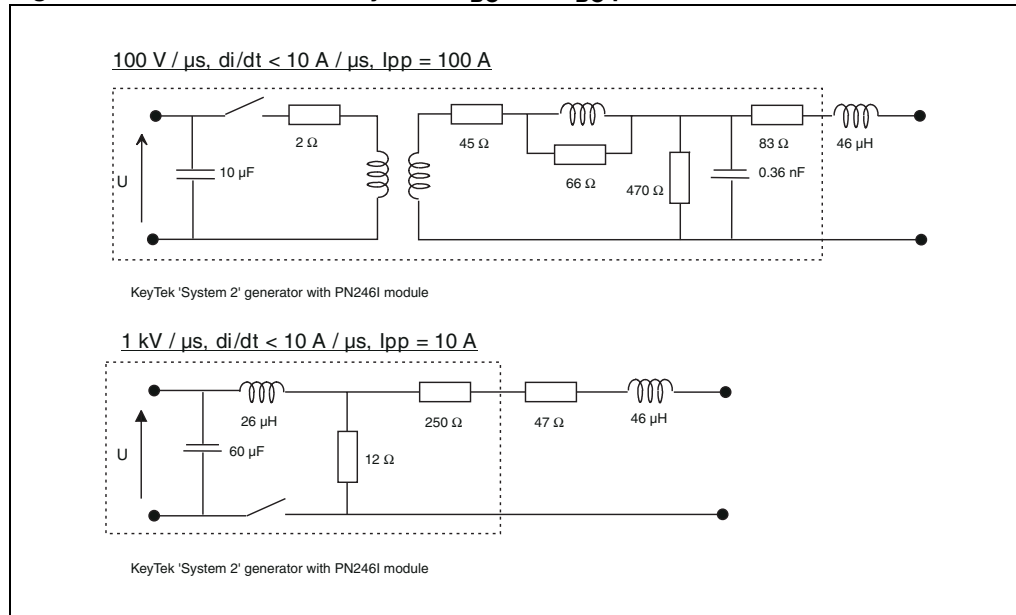

Figure 16. Test circuit 2 for I_{BO} and V_{BO} parameters

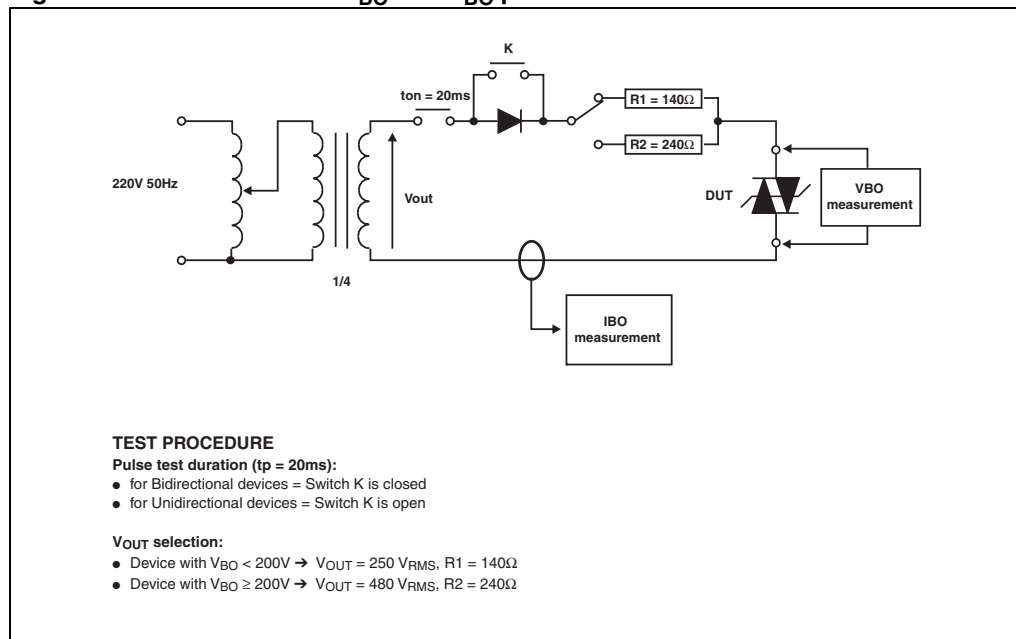
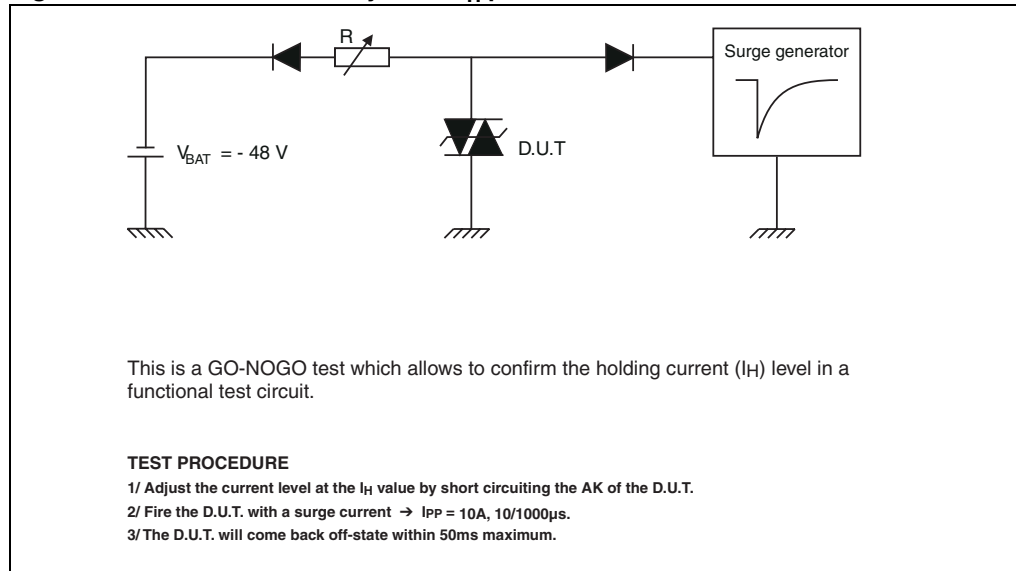
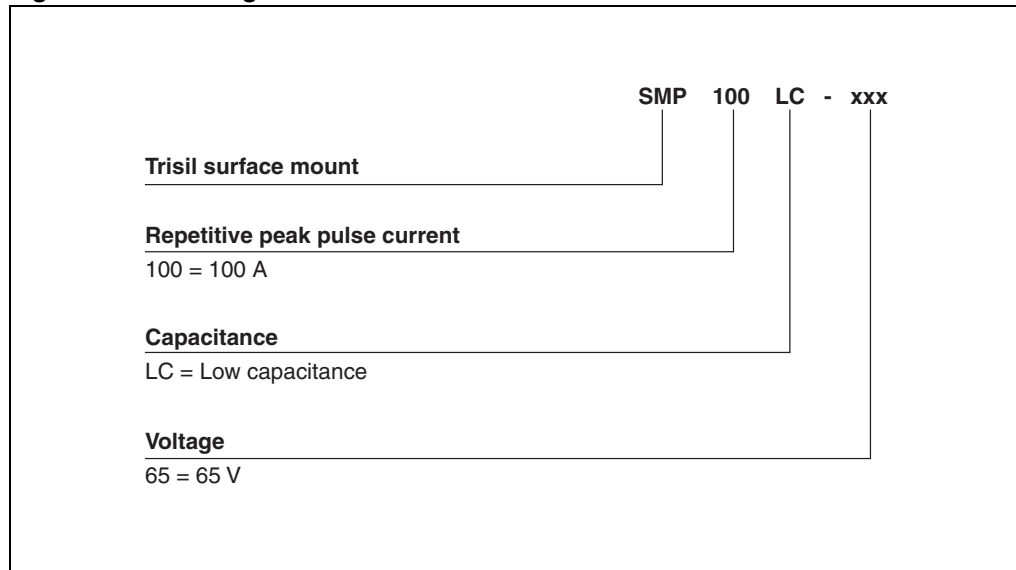

Figure 17. Test circuit 3 for dynamic I_H parameter

3 Ordering information scheme

Figure 18. Ordering information scheme



4 Package information

In order to meet environmental requirements, ST offers these devices in different grades of ECOPACK® packages, depending on their level of environmental compliance. ECOPACK® specifications, grade definitions and product status are available at: www.st.com. ECOPACK® is an ST trademark.

Table 5. SMB dimensions

Ref.	Dimensions			
	Millimeters		Inches	
	Min.	Max.	Min.	Max.
A1	1.90	2.45	0.075	0.096
A2	0.05	0.20	0.002	0.008
b	1.95	2.20	0.077	0.087
c	0.15	0.40	0.006	0.016
E	5.10	5.60	0.201	0.220
E1	4.05	4.60	0.159	0.181
D	3.30	3.95	0.130	0.156
L	0.75	1.50	0.030	0.059

Figure 19. Footprint (dimensions in mm)

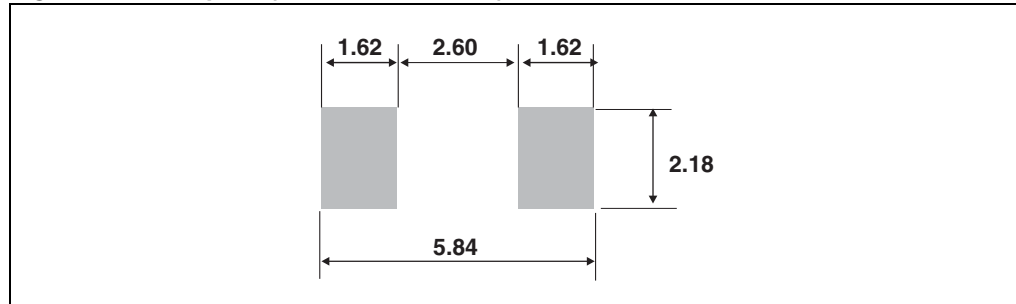

5 Ordering information

Table 6. Ordering information

Order code	Marking	Package	Weight	Base qty	Delivery mode
SMP100LC-8	PL8	SMB	0.11 g	2500	Tape & reel
SMP100LC-25	L25				
SMP100LC-35	L35				
SMP100LC-65	L06				
SMP100LC-90	L09				
SMP100LC-120	L12				
SMP100LC-140	L14				
SMP100LC-160	L16				
SMP100LC-200	L20				
SMP100LC-230	L23				
SMP100LC-270	L27				
SMP100LC-320	L32				
SMP100LC-360	L36				
SMP100LC-400	L40				

6 Revision history

Table 7. Document revision history

Date	Revision	Changes
09-Nov-2004	9	Absolute ratings values, table 3 on page 2, updated.
07-Dec-2004	10	SMP100LC-320, SMP100LC-360 and SMP100LC-400 addition.
20-Jun-2005	11	Telecom Circuit Protector added in Description .
05-Mar-2007	12	Reformatted to current standards. SMB Package information updated. Standards compliance paragraphs added to Description .
05-Jan-2010	13	Corrected vertical axis labelling in Figure 7 .

Please Read Carefully:

Information in this document is provided solely in connection with ST products. STMicroelectronics NV and its subsidiaries ("ST") reserve the right to make changes, corrections, modifications or improvements, to this document, and the products and services described herein at any time, without notice.

All ST products are sold pursuant to ST's terms and conditions of sale.

Purchasers are solely responsible for the choice, selection and use of the ST products and services described herein, and ST assumes no liability whatsoever relating to the choice, selection or use of the ST products and services described herein.

No license, express or implied, by estoppel or otherwise, to any intellectual property rights is granted under this document. If any part of this document refers to any third party products or services it shall not be deemed a license grant by ST for the use of such third party products or services, or any intellectual property contained therein or considered as a warranty covering the use in any manner whatsoever of such third party products or services or any intellectual property contained therein.

UNLESS OTHERWISE SET FORTH IN ST'S TERMS AND CONDITIONS OF SALE ST DISCLAIMS ANY EXPRESS OR IMPLIED WARRANTY WITH RESPECT TO THE USE AND/OR SALE OF ST PRODUCTS INCLUDING WITHOUT LIMITATION IMPLIED WARRANTIES OF MERCHANTABILITY, FITNESS FOR A PARTICULAR PURPOSE (AND THEIR EQUIVALENTS UNDER THE LAWS OF ANY JURISDICTION), OR INFRINGEMENT OF ANY PATENT, COPYRIGHT OR OTHER INTELLECTUAL PROPERTY RIGHT.

UNLESS EXPRESSLY APPROVED IN WRITING BY AN AUTHORIZED ST REPRESENTATIVE, ST PRODUCTS ARE NOT RECOMMENDED, AUTHORIZED OR WARRANTED FOR USE IN MILITARY, AIR CRAFT, SPACE, LIFE SAVING, OR LIFE SUSTAINING APPLICATIONS, NOR IN PRODUCTS OR SYSTEMS WHERE FAILURE OR MALFUNCTION MAY RESULT IN PERSONAL INJURY, DEATH, OR SEVERE PROPERTY OR ENVIRONMENTAL DAMAGE. ST PRODUCTS WHICH ARE NOT SPECIFIED AS "AUTOMOTIVE GRADE" MAY ONLY BE USED IN AUTOMOTIVE APPLICATIONS AT USER'S OWN RISK.

Resale of ST products with provisions different from the statements and/or technical features set forth in this document shall immediately void any warranty granted by ST for the ST product or service described herein and shall not create or extend in any manner whatsoever, any liability of ST.

ST and the ST logo are trademarks or registered trademarks of ST in various countries.

Information in this document supersedes and replaces all information previously supplied.

The ST logo is a registered trademark of STMicroelectronics. All other names are the property of their respective owners.

© 2010 STMicroelectronics - All rights reserved

STMicroelectronics group of companies

Australia - Belgium - Brazil - Canada - China - Czech Republic - Finland - France - Germany - Hong Kong - India - Israel - Italy - Japan - Malaysia - Malta - Morocco - Philippines - Singapore - Spain - Sweden - Switzerland - United Kingdom - United States of America

www.st.com