



TISP4300MMAJ, TISP4350MMAJ, TISP4360MMAJ  
TISP4300MMBJ, TISP4350MMBJ, TISP4360MMBJ

## BIDIRECTIONAL THYRISTOR OVERVOLTAGE PROTECTORS

### TISP43xxMMAJ/BJ Overvoltage Protector Series

#### Specified for:

- ITU-T Recommendation K.21  
10/700  
AC Induction and Contact
- FCC Part 68 (TIA/EIA-IS-968)  
Type A & B Surge
- UL 60950 and CSA 22.2 No.60950  
Clause 6. Power Cross
- Telcordia GR-1089-CORE  
2/10 and 10/1000  
AC Induction and Contact

#### Applications:

- TISP4300MM for:  
POTS Solid-State Relay Modems  
Protection Voltage ..... 300 V
- TISP4350MM for:  
POTS Electro-mechanical Relay Modems  
FCC Type B Ringer Voltage ..... 275 V
- TISP4360MM for:  
ADSL Modems  
ADSL + Type B Ringer Voltage ..... 290 V

#### Ion-Implanted Breakdown Region Precise and Stable Voltage

Device	V <sub>DRM</sub> V	V <sub>(BO)</sub> V
'4300	230	300
'4350	275	350
'4360	290	360

Available in SMA and SMB Packages  
SMA Saves 25 % Placement Area Over SMB

FCC Part 68 Type A Surge Compliance by  
Using Either a Fuse or 7 Ω Resistor

 ..... UL Recognized Components

#### Description

These devices are designed to limit overvoltages on the telephone line. Overvoltages are normally caused by a.c. power system or lightning flash disturbances which are induced or conducted on to the telephone line. A single device provides 2-point protection and is typically used for the protection of 2-wire telecommunication equipment (e.g. between the Ring and Tip wires for telephones and modems). Combinations of devices can be used for multi-point protection (e.g. 3-point protection between Ring, Tip and Ground).

#### How To Order

Device	Package	Carrier	Order As
TISP43xxMM	SMA/DO-214AC J-Bend (AJ)	Embossed Tape Reeled (R)	TISP43xxMMAJR-S
	SMB/DO-214AA J-Bend (BJ)		TISP43xxMMBJR-S

#### SMA Package (Top View)

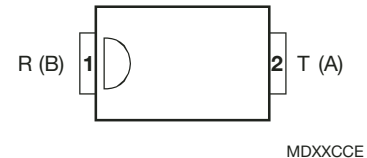

#### SMB Package (Top View)

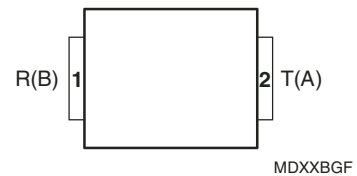

#### Device Symbol

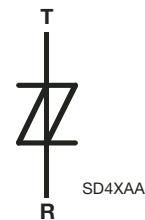

Terminals T and R correspond to the alternative line designators of A and B

#### Rated for International Surge Wave Shapes

Wave Shape	Standard	I <sub>TSP</sub> A
2/10 μs	GR-1089-CORE	250
10/160 μs	FCC Part 68	75
9/720 μs	FCC Part 68	65
10/700 μs	ITU-T K.20/45/21	65
10/560 μs	FCC Part 68	55
10/1000 μs	GR-1089-CORE	50

\*RoHS Directive 2002/95/EC Jan 27 2003 including Annex  
NOVEMBER 2001 - REVISED JANUARY 2007  
Specifications are subject to change without notice.  
Customers should verify actual device performance in their specific applications.

# TISP43xxMMAJ/BJ Overvoltage Protector Series

**BOURNS®**

## Description (Continued)

The protector consists of a symmetrical voltage-triggered bidirectional thyristor. Overvoltages are initially clipped by breakdown clamping until the voltage rises to the breakover level, which causes the device to crowbar into a low-voltage on state. This low-voltage on state causes the current resulting from the overvoltage to be safely diverted through the device. The high crowbar holding current prevents d.c. latchup as the diverted current subsides.

This TISP43xxMM range consists of three voltage variants targeted at specific applications: ADSL, electro-mechanical hook switch and solid state hook switch modems. These parts are guaranteed to voltage limit and withstand the listed international lightning surges in both polarities. Two packages are available; SMB (JEDEC DO-214AA with J-bend leads) and SMA (JEDEC DO-214AC with J-bend leads). These devices are supplied in embossed tape reel carrier pack. For alternative voltage and holding current values, consult the factory.

## Absolute Maximum Ratings, $T_A = 25\text{ }^\circ\text{C}$ (Unless Otherwise Noted)

Rating	Symbol	Value	Unit
Repetitive peak off-state voltage, '4300 '4350 '4360	$V_{DRM}$	$\pm 230$ $\pm 275$ $\pm 290$	V
Non-repetitive peak on-state pulse current (see Notes 2, 3 and 4) 2/10 $\mu\text{s}$ (GR-1089-CORE, 2/10 $\mu\text{s}$ voltage wave shape) 10/160 $\mu\text{s}$ (FCC Part 68 (TIA/EIA-IS-968), 10/160 $\mu\text{s}$ voltage wave shape) 5/320 $\mu\text{s}$ (FCC Part 68 (TIA/EIA-IS-968), 9/720 $\mu\text{s}$ voltage wave shape) 5/310 $\mu\text{s}$ (ITU-T K.44, 10/700 $\mu\text{s}$ voltage wave shape used in K.20/45/21) 10/560 $\mu\text{s}$ (FCC Part 68 (TIA/EIA-IS-968), 10/560 $\mu\text{s}$ voltage wave shape) 10/1000 $\mu\text{s}$ (GR-1089-CORE, 10/1000 $\mu\text{s}$ voltage wave shape)	$I_{TSP}$	250 75 65 65 55 50	A
Non-repetitive peak on-state current (see Notes 2, 3 and 4) 20 ms (50 Hz) full sine wave 1 s (50 Hz) full sine wave 1000 s 50 Hz/60 Hz a.c.	$I_{TSM}$	18 7 1.6	A
Junction temperature	$T_J$	-40 to +150	$^\circ\text{C}$
Storage temperature range	$T_{stg}$	-65 to +150	$^\circ\text{C}$

- NOTES: 1. For voltage values at lower temperatures derate at 0.13 %/ $^\circ\text{C}$ .  
 2. Initially, the TISP43xxMM must be in thermal equilibrium with  $T_J = 25\text{ }^\circ\text{C}$ .  
 3. The surge may be repeated after the TISP43xxMM returns to its initial conditions.  
 4. EIA/JESD51-2 environment and EIA/JESD51-3 PCB with standard footprint dimensions connected with 5 A rated printed wiring track widths. Derate current values at -0.61 %/ $^\circ\text{C}$  for ambient temperatures above 25  $^\circ\text{C}$ .

## Overload Ratings, $T_A = 25\text{ }^\circ\text{C}$ (Unless Otherwise Noted)

Rating	Symbol	Value	Unit
Peak overload on-state current, Type A impulse (see Note 5) 10/160 $\mu\text{s}$ 10/560 $\mu\text{s}$	$I_{T(OV)M}$	200 100	A
Peak overload on-state current, a.c. power cross tests UL 60950 (see Note 5)	$I_{T(OV)M}$	See Figure 10 for current versus time	A

- NOTE 5: These electrical stress levels may damage the TISP43xxMM silicon chip. After test, the pass criterion is either that the device is functional or, if it is faulty, that it has a short circuit fault mode. In the short circuit fault mode, the following equipment is protected as the device is a permanent short across the line. The equipment would be unprotected if an open circuit fault mode developed.

# TISP43xxMMAJ/BJ Overvoltage Protector Series

**BOURNS®**

## Recommended Operating Conditions

Component		Min	Typ	Max	Unit
R <sub>S</sub>	series resistor for FCC Part 68, 10/160, 10/560 type A surge survival	13			Ω
	series resistor for FCC Part 68, 9/720 type B surge survival	0			Ω
	series resistor for GR-1089-CORE first-level and second-level surge survival	15			Ω
	series resistor for K.20, K.21 and K.45 1.5 kV, 10/700 surge survival	0			Ω
	series resistor for K.21 coordination with a 400 V primary protector	6.6			Ω

## Electrical Characteristics for the R and T Terminals, T<sub>A</sub> = 25 °C (Unless Otherwise Noted)

Parameter	Test Conditions	Min	Typ	Max	Unit
I <sub>DRM</sub>	Repetitive peak off-state current V <sub>D</sub> = V <sub>DRM</sub> T <sub>A</sub> = 25 °C T <sub>A</sub> = 85 °C			±5 ±10	μA
V <sub>(BO)</sub>	Breakover voltage dv/dt = ±250 V/ms, R <sub>SOURCE</sub> = 300 Ω '4300 '4350 '4360			±300 ±350 ±360	V
I <sub>(BO)</sub>	Breakover current dv/dt = ±250 V/ms, R <sub>SOURCE</sub> = 300 Ω			±0.8	A
I <sub>H</sub>	Holding current I <sub>T</sub> = ±5 A, di/dt = -/+30 mA/ms	±0.15		±0.6	A
dv/dt	Critical rate of rise of off-state voltage Linear voltage ramp, Maximum ramp value < 0.85V <sub>DRM</sub>	±5			kV/μs
I <sub>D</sub>	Off-state current '4300, V <sub>D</sub> = ±207 V '4350, V <sub>D</sub> = ±248 V '4360, V <sub>D</sub> = ±261 V			±2	μA
I <sub>D</sub>	Off-state current V <sub>D</sub> = ±50 V			±10	±10
C <sub>off</sub>	Off-state capacitance f = 1 MHz, V <sub>d</sub> = 1 V rms, V <sub>D</sub> = ±1 V f = 1 MHz, V <sub>d</sub> = 1 V rms, V <sub>D</sub> = ±50 V			40 18	pF

## Thermal Characteristics

Parameter	Test Conditions	Min	Typ	Max	Unit
R <sub>θJA</sub>	Junction to free air thermal resistance EIA/JESD51-3 PCB, I <sub>T</sub> = I <sub>TSM(1000)</sub> , T <sub>A</sub> = 25 °C, (see Note 6)			115	°C/W
	265 mm x 210 mm populated line card, 4-layer PCB, I <sub>T</sub> = I <sub>TSM(1000)</sub> , T <sub>A</sub> = 25 °C		52		

NOTE 6: EIA/JESD51-2 environment and PCB has standard footprint dimensions connected with 5 A rated printed wiring track widths.

NOVEMBER 2001 - REVISED JANUARY 2007

Specifications are subject to change without notice.

Customers should verify actual device performance in their specific applications.

Parameter Measurement Information

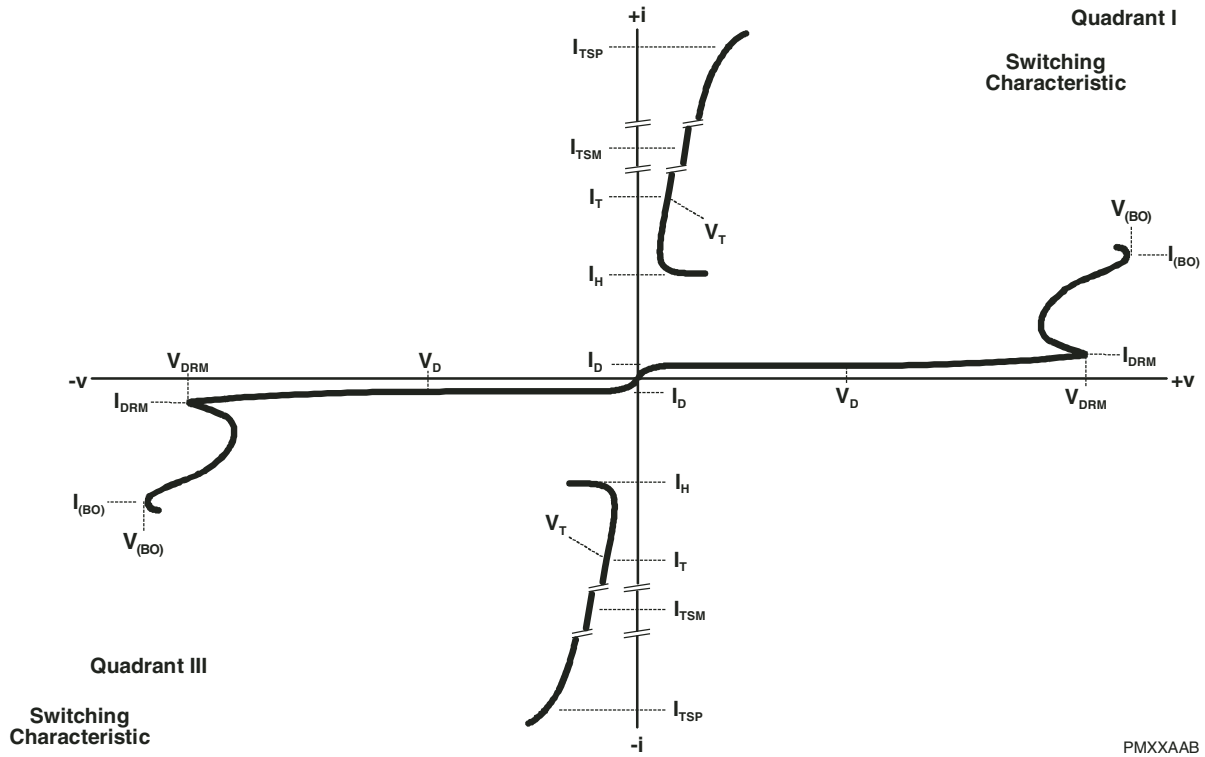

**Figure 1. Voltage-current Characteristic for T and R Terminals**  
**All Measurements are Referenced to the R Terminal**

## Typical Characteristics

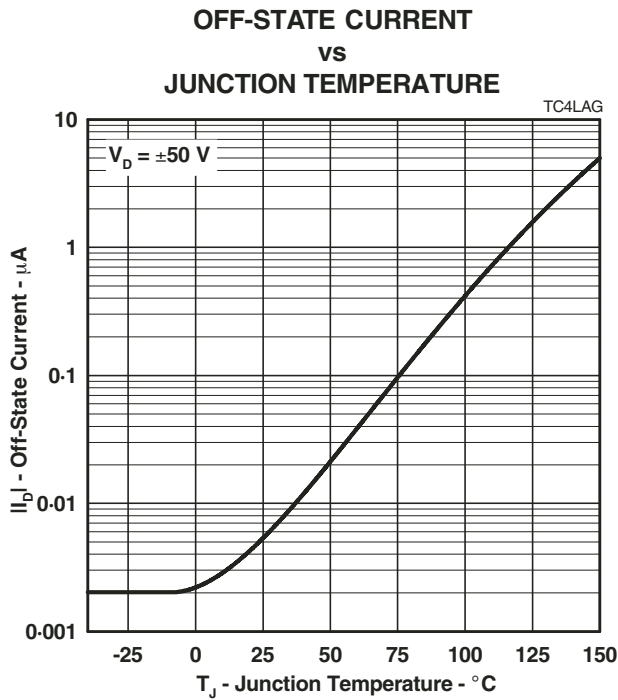

Figure 2.

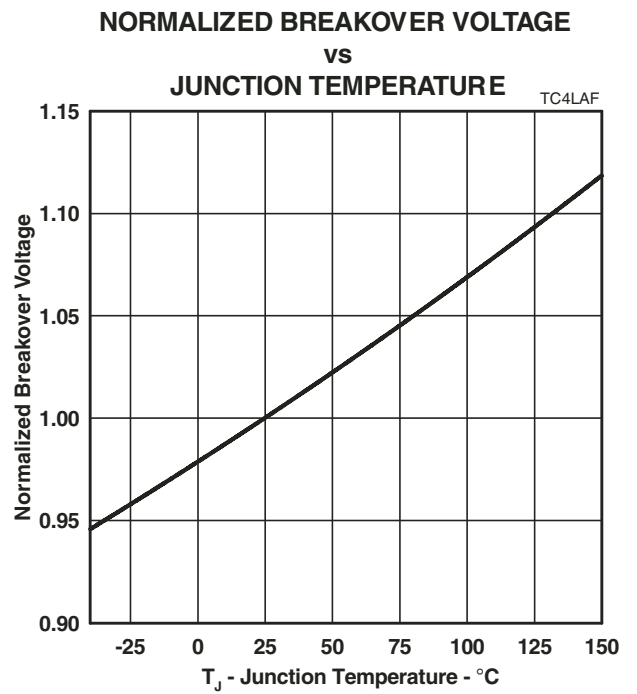

Figure 3.

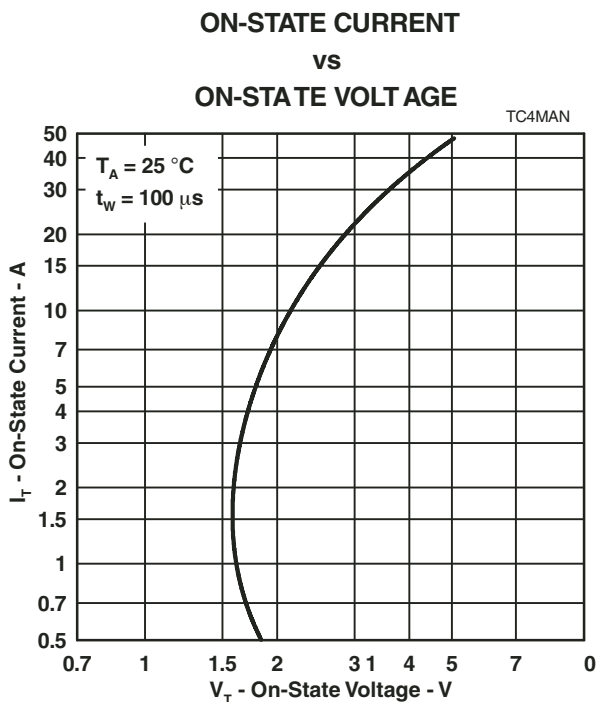

Figure 4.

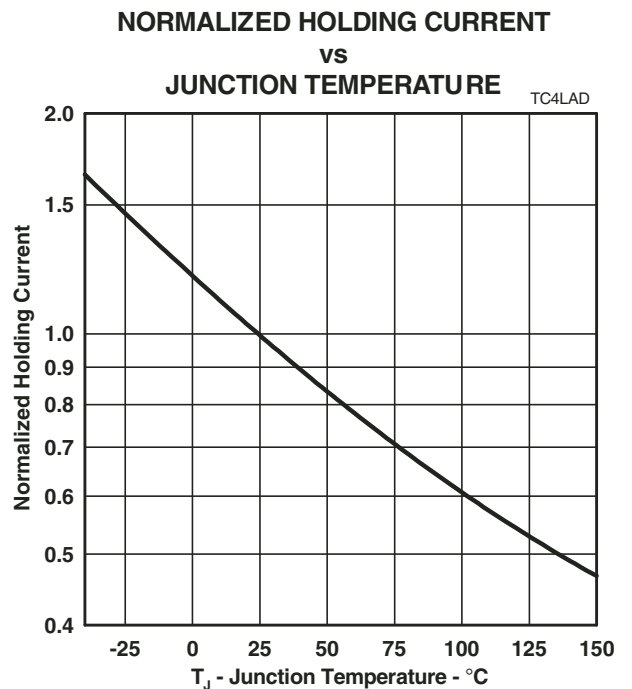

Figure 5.

NOVEMBER 2001 - REVISED JANUARY 2007  
 Specifications are subject to change without notice.  
 Customers should verify actual device performance in their specific applications.

## Typical Characteristics

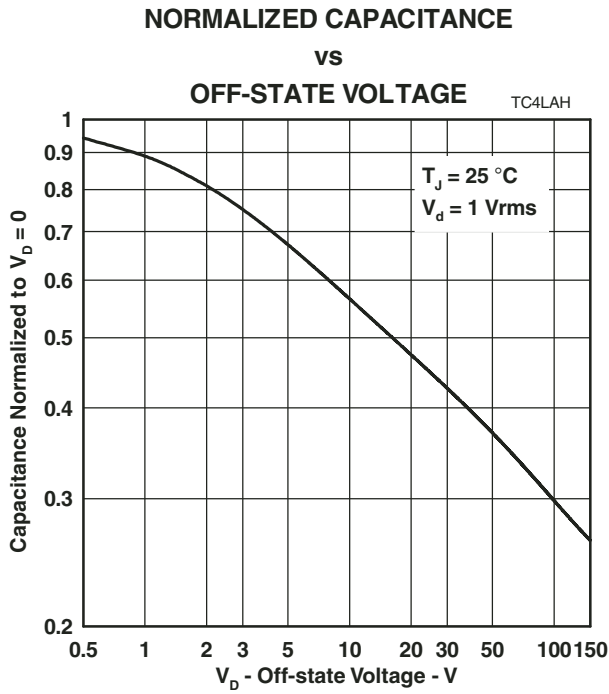

Figure 6.

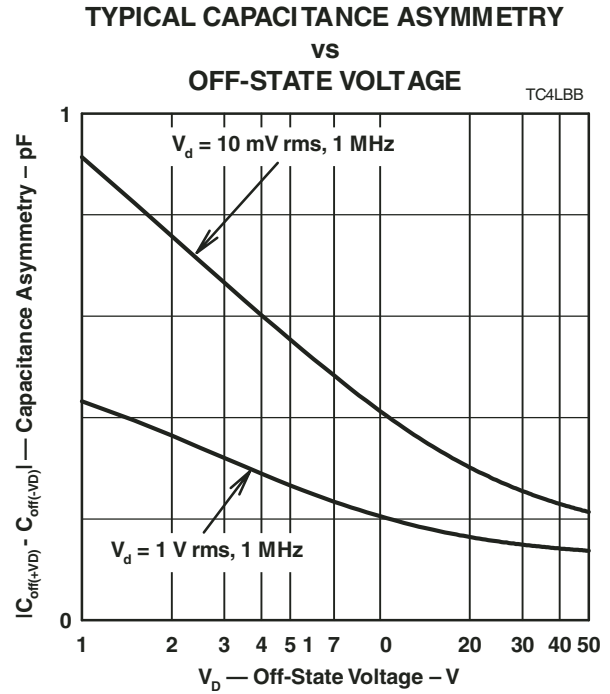

Figure 7.

Rating and Thermal Information

**NON-REPETITIVE PEAK ON-STATE CURRENT  
vs  
CURRENT DURATION**

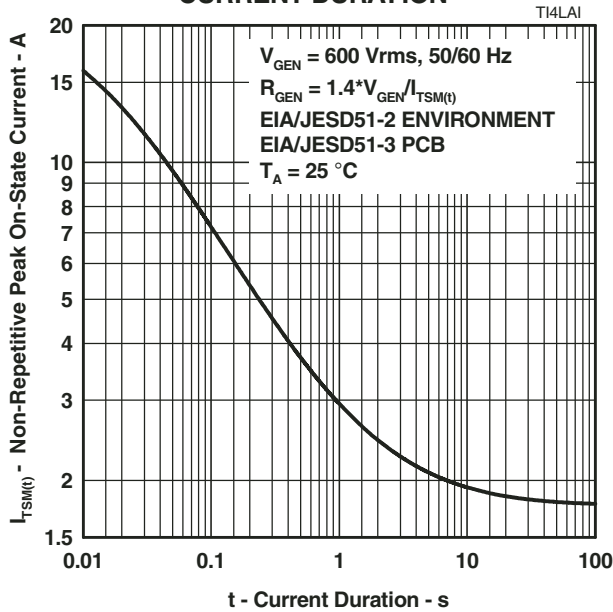

Figure 8.

**V<sub>DRM</sub> DERATING FACTOR  
vs  
MINIMUM AMBIENT TEMPERATURE**

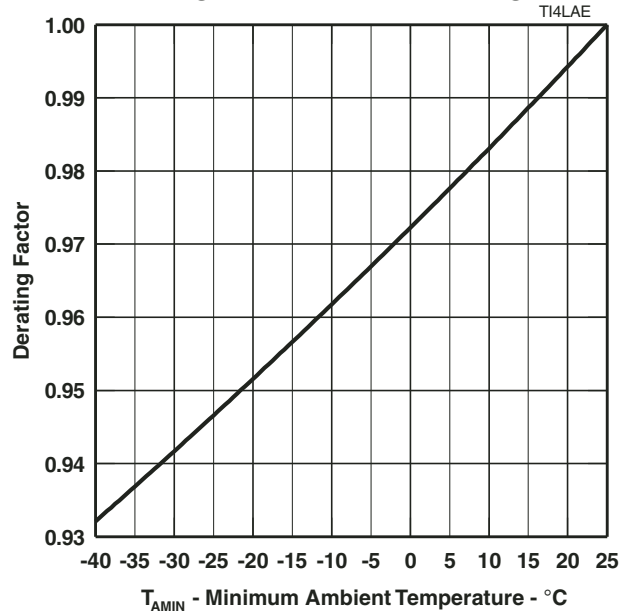

Figure 9.

**PEAK OVERLOAD ON-STATE CURRENT  
vs  
CURRENT DURATION**

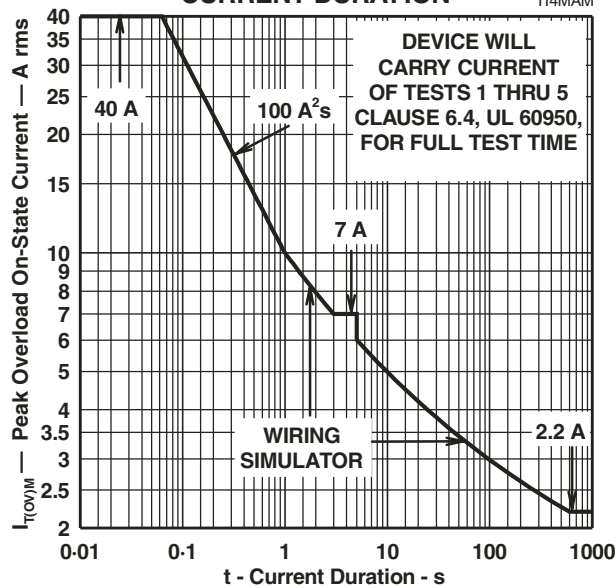

Figure 10. Peak Overload On-State Current against Duration

NOVEMBER 2001 - REVISED JANUARY 2007  
Specifications are subject to change without notice.  
Customers should verify actual device performance in their specific applications.

# TISP43xxMMAJ/BJ Overvoltage Protector Series

**BOURNS®**

## APPLICATIONS INFORMATION

### FCC Part 68, ACTA, TIA and EIA

From 2001, the registrations for FCC equipment changed from the FCC to ACTA, Administrative Council for Terminal Attachments. For this function, ACTA needed to adopt a US National standard specifying terminal equipment requirements. The TIA, Telecommunications Industry Association, in conjunction with the EIA, Electronic Industries Alliance, created TIA/EIA-IS-968 for this purpose. The first issue of TIA/EIA-IS-968 is essentially a renumbered version of the FCC Part 68 requirement. Clause and figure changes are shown in the table.

Item	FCC Part 68	TIA/EIA-IS-968
Telephone Line Surge – Type A	Clause 68.302 (b)	Clause 4.2.2
Telephone Line Surge – Type B	Clause 68.302 (c)	Clause 4.2.3
Simplified Surge Generator	Fig. 68.302 (a)	Figure 4.1
Open Circuit voltage Wave shape	Fig. 68.302 (b)	Figure 4.2
Short Circuit Current Wave shape	Fig. 68.302 (c)	Figure 4.3

### TIA/EIA-IS-968 (FCC Part 68) Impulse Testing

To verify the withstand capability and safety of the equipment, standards require that the equipment is tested with various impulse wave forms. The table below shows values for the TIA/EIA-IS-968 and ITU-T recommendation K.21.

Standard	Test Condition V	Peak Voltage V	Voltage Wave Form $\mu$ s	Peak Current A	Current Wave Form $\mu$ s	Fictive Impedance $\Omega$ □	TISP43xxMM Rating A	Series Resistance $\Omega$ □
TIA/EIA-IS-968 (FCC Part 68)	Longitudinal	1500	10/160	200	10/160	7.5	75	2 x 13
	Metallic	800	10/560	100	10/560	8	55	7
	Longitudinal	1500	9/720 †	37.5	5/320 †	40	65	0
	Metallic	1000	9/720 †	25	5/320 †	40	65	0
ITU-T K.21 ‡ Basic Level	Transverse	1500	10/700	37.5	5/310	40	65	0
		4000		100				6.6
ITU-T K.21 ‡ Enhanced Level	Transverse	1500	10/700	37.5	5/310	40	65	0
		6000		125				6.2

† TIA/EIA-IS-968 terminology for the wave forms produced by the ITU-T recommendation K.21 10/700 impulse generator

‡ Values assume the TISP43xxMM is connected inter-conductor and a 400 V primary is used

If the impulse generator current exceeds the protector's current rating then a series resistance can be used to reduce the current to the protector's rated value to prevent possible failure. For the new edition of ITU-T recommendation K.21 (2000) some series resistance might be needed to pass the impulse coordination test. The value for a 400 V primary protector is given in the table.

The required value of device survival series resistance for a given waveform is given by the following calculations. First, the minimum total circuit impedance is found by dividing the impulse generator's peak voltage by the protector's rated current. The impulse generator's fictive impedance (generator's peak voltage divided by peak short circuit current) is then subtracted from the minimum total circuit impedance to give the required value of series resistance.

For the TIA/EIA-IS-968 10/560 waveform the following values result. The minimum total circuit impedance is  $800/55 = 15 \Omega$  and the generator's fictive impedance is  $800/100 = 8 \Omega$ . For an inter-conductor connected TISP43xxMM, this gives a minimum series resistance value of  $15 - 8 = 7 \Omega$ . The 10/160 waveform only needs to be considered if the TISP43xxMM is connected from the conductor to ground. In this case the conductor series resistance is  $12.5 \Omega$  per conductor.

### Fuse Values for TIA/EIA-IS-968 (FCC Part 68)

Fuses must not operate on the Type B surge. To survive a 37.5 A Type B surge, the fuse needs to have a melting  $I^2t$  of greater than  $0.7 A^2s$ .

To survive the Type A surges a fuse melting  $I^2t$  value of greater than  $10 A^2s$  for 10/160 and  $8 A^2s$  for 10/560 is needed. By using a fuse which does not operate on Type B surges ( $I^2t > 0.7 A^2s$ ) and does operate on Type A surges ( $I^2t < 8 A^2s$ ) a non-operational pass can be achieved for Type A testing.

NOVEMBER 2001 - REVISED JANUARY 2007

Specifications are subject to change without notice.

Customers should verify actual device performance in their specific applications.



# TISP43xxMMAJ/BJ Overvoltage Protector Series

**BOURNS®**

## TIA/EIA-IS-968 (FCC Part 68) System Voltage Levels

The protector should not clip or limit the voltages that occur in normal system operation. If the maximum system voltages are not known, then designers often used the voltages for the FCC Part 68 "B" ringer. The "B" ringer has a d.c. voltage of 56.5 V and a maximum a.c. ring voltage of 150 V rms. The resultant waveform is shown in Figure 11. The maximum voltage is -269 V, but, because of possible wiring reversals, the protector should have a working voltage of  $\pm 269$  V minimum. The TISP4350MM protector meets this requirement with a working voltage,  $V_{DRM}$ , of  $\pm 275$  V and a protection voltage,  $V_{(BO)}$ , of  $\pm 350$  V. Figure 12 shows the TISP4350MM voltages relative to the POTS -269 V peak ringing voltage.

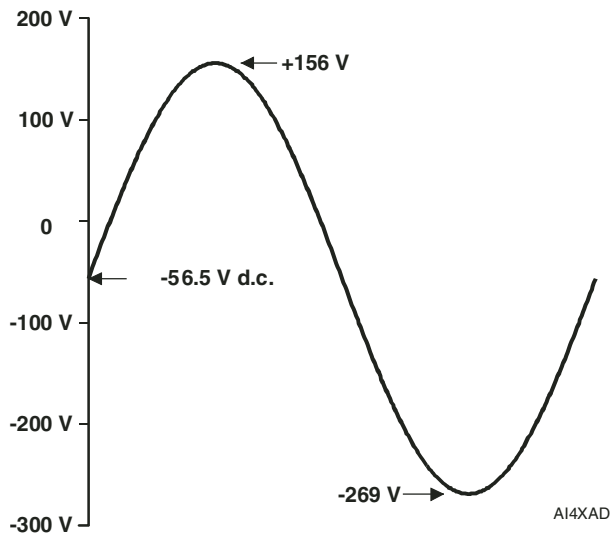

Figure 11.

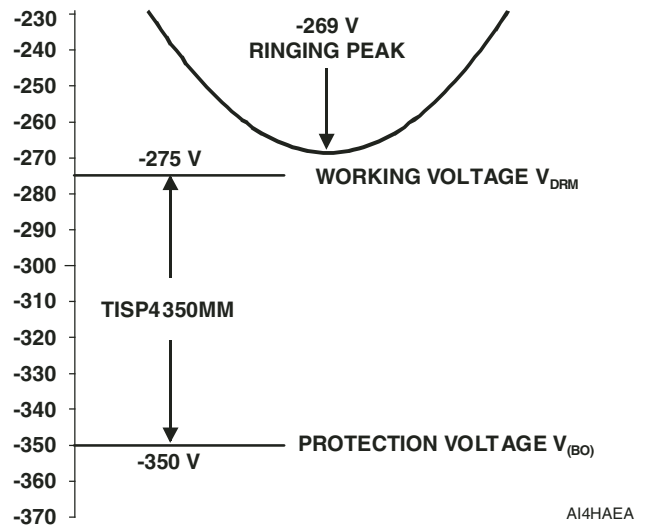

Figure 12.

## ADSL System Voltage Levels

The ADSL signal can be as high as  $\pm 15$  V and this adds to the POTS signal making a peak value of -284 V. This increased signal value of -284 V would be clipped by the TISP4350MM, which only allows for a -275 V signal. The TISP4360MM has been specified to overcome this problem by having a higher working voltage of  $\pm 290$  V. Figure 13 shows the TISP4360MM voltages relative to the -284 V peak ADSL plus POTS ringing voltage. The  $\pm 15$  V ADSL signal is shown as a gray band in Figure 13.

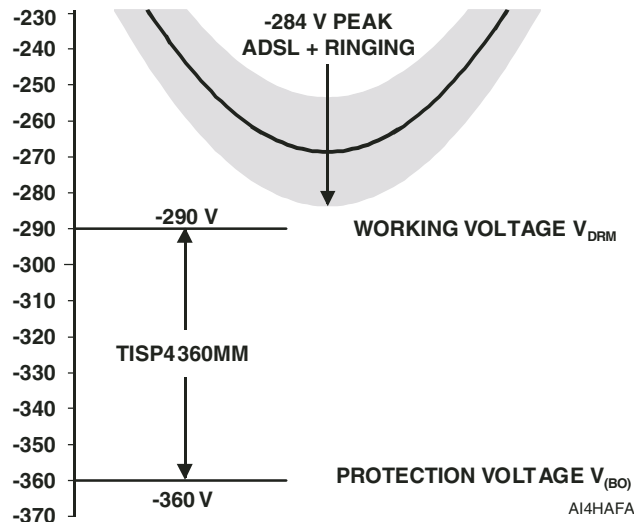

Figure 13.

NOVEMBER 2001 - REVISED JANUARY 2007  
 Specifications are subject to change without notice.  
 Customers should verify actual device performance in their specific applications.

# TISP43xxMMAJ/BJ Overvoltage Protector Series

**BOURNS®**

## IEC 60950, UL 1950/60950, CSA C22.2 No. 950/60950 and EN 60950

These electrical safety standards for IT (Information Technology) equipment at the customer premise use the IEC (International Electrotechnical Commission) 60950 standard as the core document. The IEC 60950 covers fundamental safety criteria such as creepage and isolation. The connection to a telecommunication network voltage (TNV) is covered in clause 6.

Europe is harmonized by CENELEC (Comité Européen de Normalization Electro-technique) under EN 60950 (included in the Low Voltage Directive, CE mark). Up to the end of 2000, the US had UL (Underwriters Laboratories) 1950 and Canada CSA (Canadian Standards Authority) C22.2 No. 950. The US and Canadian standards include regional changes and additions to the IEC 60950. A major addition is the inclusion of clause 6.6, power cross withstand containing the flowchart Figure 18b and annex NAC covering testing. Remarks made for UL 1950 will generally be true for CSA 22.2 No. 950.

In December 2000, UL released UL 60950, which will run concurrently with UL 1950 until 2003, after which submittals can only be made for UL 60950. The equivalent Canadian document is designated CSA C22.2 No. 60950. Changes and differences between UL 1950 and UL 60950 do not affect power cross testing nor evaluation criteria. Clause and figure numbering has changed between the standards and these changes are shown in the table. In this document, these two standards are being jointly referred to as UL 60950 and the clause and figure numbering referenced will be from UL 60950.

Item	UL 1950	UL 60950
Protection against overvoltage from power line crosses	Clause 6.6	Clause 6.4
Overvoltage flowchart	Figure 18b	Figure 6C

## UL 60950, Clause 6.4 – Power Cross

Figure 14 shows the criterion flow for UL 60950 power cross. (This is a modified version of UL60950, Figure 6C — Overvoltage flowchart.) There are many routes for achieving a pass result. For discussion, each criterion has been given a letter reference. Brief details of any electrical testing is given as a criterion note. Test pass criteria are given in the bottom table of Figure 14.

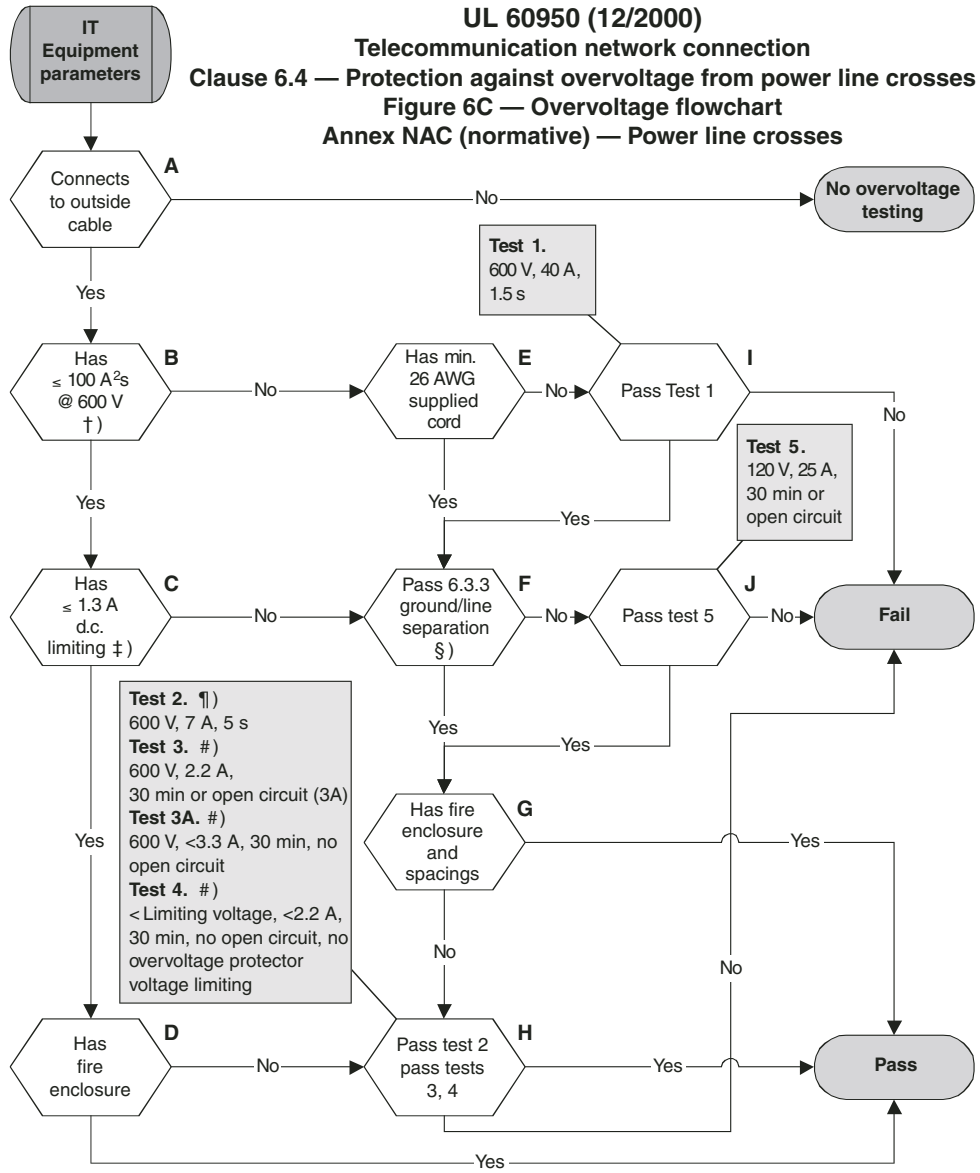

**NOTES**  
 †) Overcurrent protector  $I^2t$  must be lower than any other equipment element which carries the same current.  
 ‡) UL accepts that a fuse with a 1 A or less rating meets the 1.3 A criterion.  
 §) Pass for 120 V a.c. between telecommunication line and ground current < 10 mA.  
 ¶) Test 2 not required if the equipment d.c. breaking is 1.3 A or less, see comment ‡).  
 #) Tests 3 and 4 not required for equipment with less than 1000 m of outside cable.

Pass criteria	Test 1	Test 2	Test 3	Test 3A	Test 4	Test 5
No cheesecloth charring	✓	✓	✓	✓	✓	✓
Insulation OK	✓	✓	✓	✓	✓	✓
Wiring simulator (fuse) OK	✓					✓
$I^2t < 100 A^2s @ 600 V a.c.$	✓					

Users must verify requirements against latest issue of UL 60950  
 AIUL60950A

**Figure 14. UL 60950 Power Cross Flow Chart**

NOVEMBER 2001 - REVISED JANUARY 2007  
 Specifications are subject to change without notice.  
 Customers should verify actual device performance in their specific applications.

## Power Cross Pass Routes

This discussion covers typical modem flows.

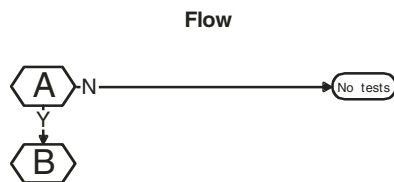

### Box A

The criterion for box A is if the modem connects to an outside TNV line.

The majority of modems will be connected to an outside line, so the answer is yes. The yes path goes to box B.

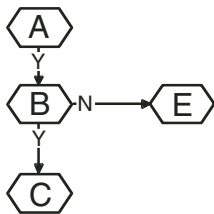

### Box B

The criterion for box B is if the equipment has a limit of  $\leq 100 \text{ A}^2\text{s}$  at 600 V rms for Test 1. Many interpret this as a fuse with  $I^2t \leq 100 \text{ A}^2\text{s}$  and often miss the 600 V a.c. breaking requirement. However, the current loop is completed by the fuse and other equipment components. To ensure that the fuse  $I^2t$  sets the equipment performance, the other current loop components, such as the printed wiring (PW), must have higher  $I^2t$  values than the fuse. Certainly the fuse  $I^2t$  needs to be lower than 100  $\text{A}^2\text{s}$  but other components, for example IC packaging, may impose a hazard-free limit of 10  $\text{A}^2\text{s}$ . (This conflicts with TIA/EIA-IS-968 Type A surge pass requirement of 8  $\text{A}^2\text{s}$ .)

A yes leads to box C and a no to box E.

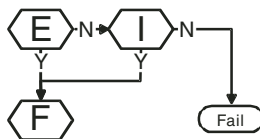

### Boxes E and I

The criterion for box E is for a minimum telecommunications line cord of No. 26 AWG to be supplied or specified.

A yes leads to box F and a no to box I.

The criterion for box I is to pass Test 1.

If all the four pass criteria of Test 1 are met, this is a yes and the flow goes to box F.

A no result fails the equipment.

## Power Cross Pass Routes (Continued)

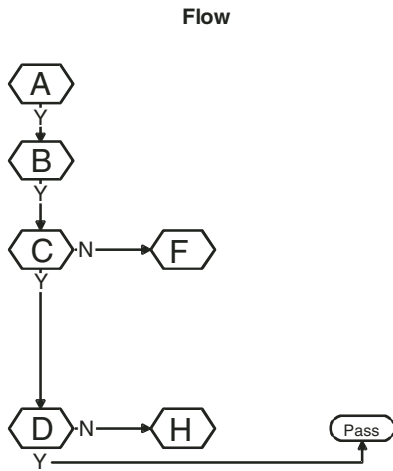

### Boxes C and D

The criterion for box C is overcurrent protection that reduces currents above 1.3 A. This requirement is met by a 1 A fuse (a 1 A current fusing rating, not an IEC 1 A current carrying rating).

Modems which pass FCC Part 68 Type B surges and non-operationally pass Type A surges can use a fuse of 1 A or less, so the *yes* path to box D can be followed. High performance modems which operationally pass both Type A and B surges would need a fuse of greater than 1 A and so follow the *no* path to box F.

The criterion for box D is a fire enclosure.

Few modems can afford fire enclosures. However, for an internal modem in a known computer case, the case may be evaluated as a fire enclosure. A successful case evaluation will give a *yes* and an equipment pass.

More likely, the modem will not have a fire enclosure. The *no* flow goes to box H.

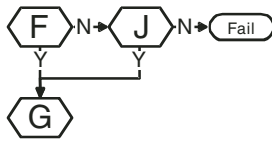

### Boxes F and J

The criterion for box F is a pass to clause 6.3.3 requirements.

A *yes* goes to box G and a *no* goes to box J.

The criterion for box J is to pass Test 5.

If all the three pass criteria of Test 5 are met, this is a *yes* and the flow goes to box G.

A *no* result fails the equipment.

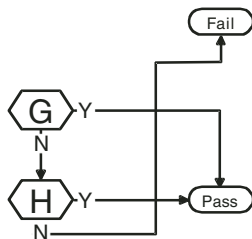

### Boxes G and H

The criterion for box G is a fire enclosure and spacings (See box D comments).

A *yes* result passes the equipment and a *no* result leads to box H.

The criterion for box H is to pass Tests 2, 3 and 4. Test 2 is not required if there is overcurrent protection that reduces currents above 1.3 A (See box C).

High performance modems, using fuses and without fire enclosures, must pass tests 2, 3, possibly 3A if the fuse opens, and 4. For standard modems, using fuses of 1 A or less and without fire enclosures, tests 3, 3A and 4 must be passed.

If the two pass criteria of each of the tests performed are met, this is a *yes* and the equipment passes.

A *no* result fails the equipment.

## TISP43xxMMAJ/BJ Overvoltage Protector Series

**BOURNS®**

### Fuse Values for UL 1950/60950

Fuses for the UL 1950/60950 power cross need to break the specified currents at 600 V a.c. - ordinary fuses will not do! Fuse specification terms like *short circuit capabilities to UL 1459 and UL 1950/60950, 40 A, 7 A and 2.2 A at 600 V a.c.* ensure that the 600 V breaking is met.

The requirement of Figure 14, box B, limits the fuse  $I^2t$  to less than 100 A<sup>2</sup>s.

Box C, with its 1.3 A limit gives a flow division. Modems passing the TIA/EIA-IS-968 Type A surge in a non-operational mode, could use a fuse of 1 A rating or less and satisfy the 1.3 A limit and move to box D. Modems operationally passing the Type A surge will tend to use a 1.25 A fuse, such as the Bel SMP 1.25, and move to box F. Fuses with ratings of 2 A and above may not operate before the wiring simulator fails (typically 3 A d.c.).

### TISP43xxMM and UL 1950/60950 Power Cross

The TISP43xxMM conducts current for periods greater than the power cross test times, Figure 10, so the TISP43xxMM is not a major factor in UL 1950/60950 compliance. The main design task for UL 1950/60950 power cross is about enclosure design and the selection of the other components that are subject to power cross. A UL specified fuse together with a TISP43xxMM gives a simple design approach to meeting the power cross requirements.

### Summary of TISP4350MM, TISP4360MM and TISP4300MM Applications

The TISP4350MM is designed to meet the FCC Part 68 Type B ringer voltages and is suitable for electro-mechanical hook switch POTS modems, Figure 15. For ADSL modems, the TISP4360MM should be used as it has an increased working voltage to avoid clipping the ADSL signal, Figure 16. The solid state hook switch used in POTS modems may be limited in voltage and dissipation capability. To reduce the voltage stress level on the solid state switch, a 300 V  $V_{(BO)}$  TISP4300MM can be used, Figure 17.

NOVEMBER 2001 - REVISED JANUARY 2007

Specifications are subject to change without notice.  
Customers should verify actual device performance in their specific applications.

## Application Circuits

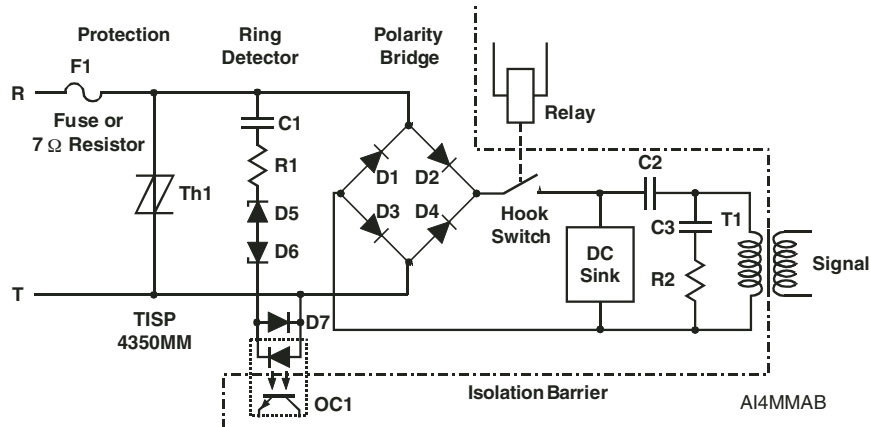

Figure 15. Basic TISP4350MM Electro-Mechanical Hook Switch Protection

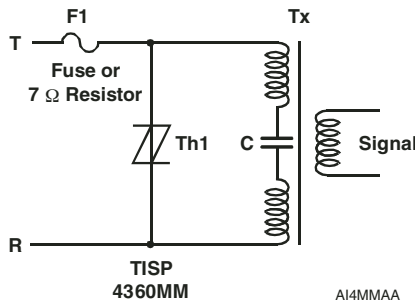

Figure 16. Basic TISP4360MM ADSL Interface

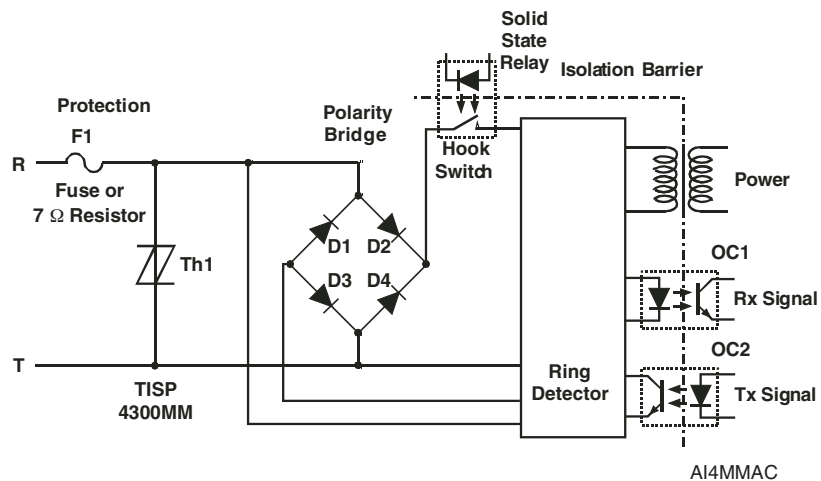

Figure 17. Basic TISP4300MM Electronic Hook Switch Protection

# TISP43xxMMAJ/BJ Overvoltage Protector Series

**BOURNS®**

## MECHANICAL DATA

### Recommended Printed Wiring Land Pattern Dimensions

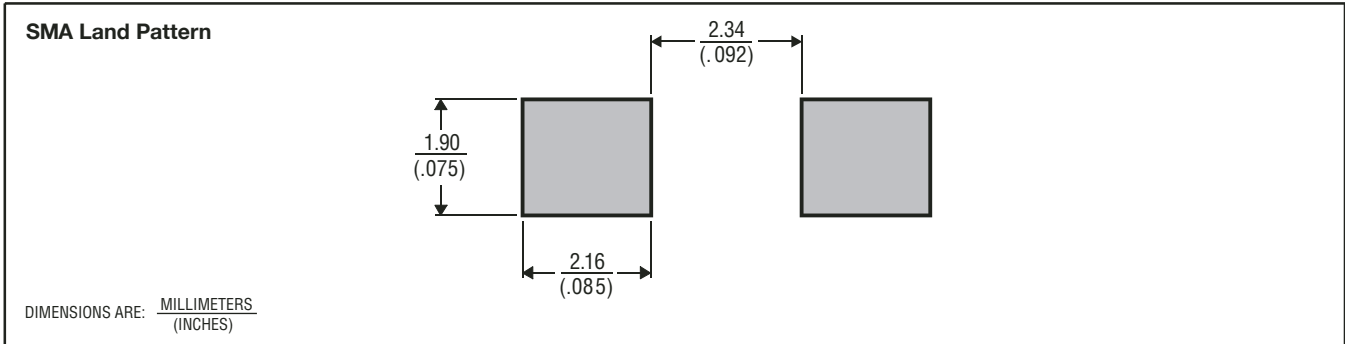

MDXXBIC

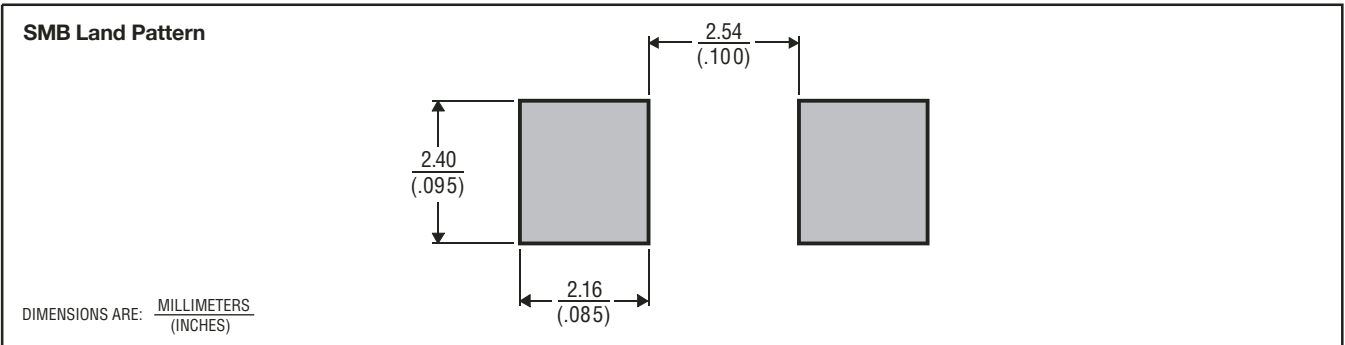

MDXXBIB

### Device Symbolization Code

Devices will be coded as below. As the device parameters are symmetrical, terminal 1 is not identified.

SMA Package	Symbolization Code	SMB Package	Symbolization Code
TISP4300MMAJ	430MM	TISP4300MMBJ	4300MM
TISP4350MMAJ	435MM	TISP4350MMBJ	4350MM
TISP4360MMAJ	436MM	TISP4360MMBJ	4360MM

### Carrier Information

Devices are shipped in one of the carriers below. Unless a specific method of shipment is specified by the customer, devices will be shipped in the most practical carrier. For production quantities, the carrier will be embossed tape reel pack. Evaluation quantities may be shipped in bulk pack or embossed tape.

Package	Carrier	Standard Quantity
SMA	Embossed Tape Reel Pack	5000
SMB		3000

"TISP" is a trademark of Bourns, Ltd., a Bourns Company, and is Registered in U.S. Patent and Trademark Office.  
 "Bourns" is a registered trademark of Bourns, Inc. in the U.S. and other countries.

NOVEMBER 2001 - REVISED JANUARY 2007  
 Specifications are subject to change without notice.  
 Customers should verify actual device performance in their specific applications.