



Micro Commercial Components



Micro Commercial Components
 20736 Marilla Street Chatsworth
 CA 91311
 Phone: (818) 701-4933
 Fax: (818) 701-4939

MMBD301

Pin Configuration
 Top View

Features

- High Efficiency UHF and VHF Detector Applications.
- Low Capacitance and Low Reverse Leakage
- Extremely Low Minority Carrier Lifetime – 15ps (Typ)
- Lead Free Finish/Rohs Compliant ("P" Suffix designates RoHS Compliant. See ordering information)
- Epoxy meets UL 94 V-0 flammability rating
- Moisture Sensitivity Level 1

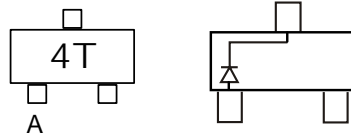

30 Volts Schottky Barrier Diodes

SOT-23

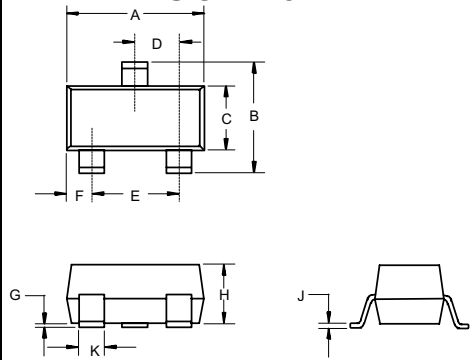

DIM	INCHES		MM		NOTE
	MIN	MAX	MIN	MAX	
A	.110	.120	2.80	3.04	
B	.083	.098	2.10	2.64	
C	.047	.055	1.20	1.40	
D	.035	.041	.89	1.03	
E	.070	.081	1.78	2.05	
F	.018	.024	.45	.60	
G	.0005	.0039	.013	.100	
H	.035	.044	.89	1.12	
J	.003	.007	.085	.180	
K	.015	.020	.37	.51	

Maximum Ratings

- Operating Temperature: -55°C to +125°C
- Storage Temperature: -55°C to +150°C

Rating	Symbol	Value	Unit
Reverse Voltage	V_R	30	V
Forward Power Dissipation @ $T_A = 25^\circ\text{C}$ Derate above 25°C	P_{TOT}	200 2.0	mW mW/°C

Electrical Characteristics @ 25°C Unless Otherwise Specified

Characteristic	Symbol	Min	Typ	Max	Test Cond.
Reverse Breakdown Voltage	$V_{(BR)R}$	30V			$I_{FM} = 10\mu\text{A}$ $T_A = 25^\circ\text{C}$
Forward Voltage	V_F		0.52V 0.38V	0.60V 0.45V	$I_{FM} = 10\text{mA};$ $I_{FM} = 1.0\text{mA};$
Reverse Leakage	I_R		13nA	200nA	$V_R = 25\text{Volts}$
Junction Capacitance	C_J		0.9pF	1.5pF	Measured at $f = 1.0\text{MHz},$ $V_R = 15\text{V}$

Suggested Solder Pad Layout

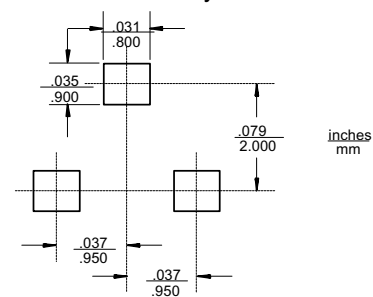

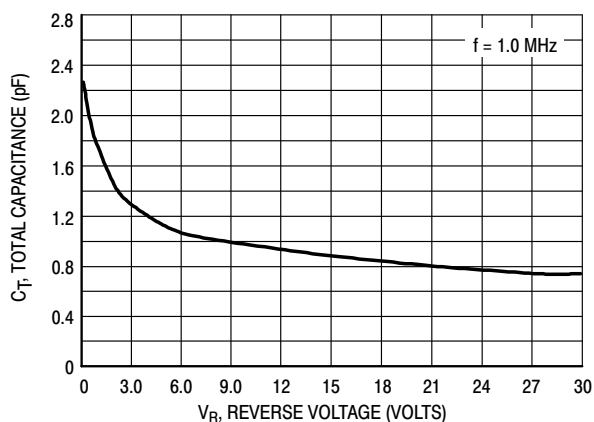

Figure 1. Total Capacitance

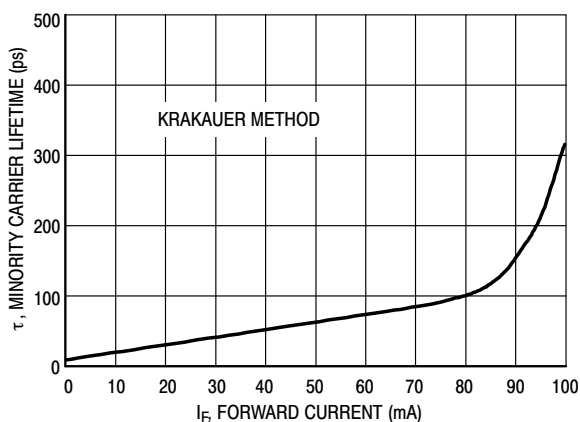

Figure 2. Minority Carrier Lifetime

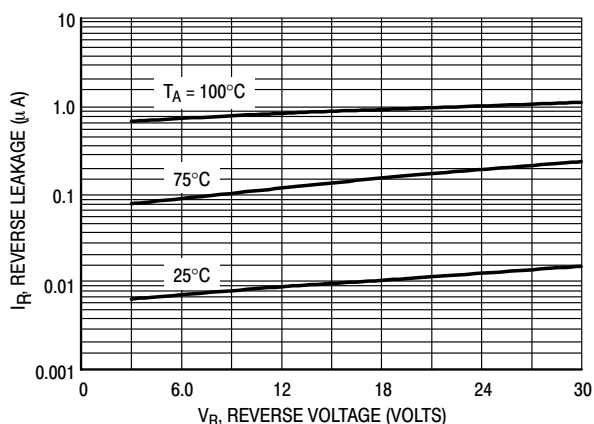

Figure 3. Reverse Leakage

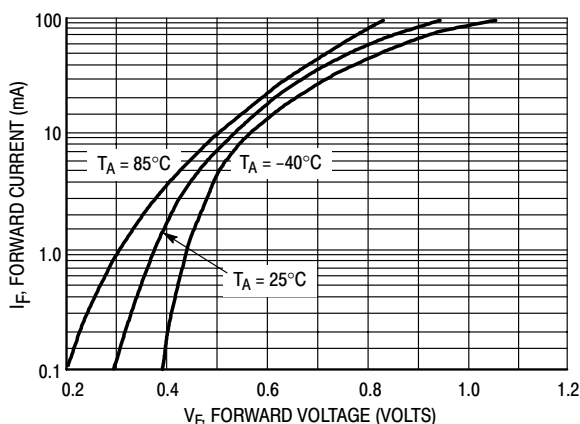

Figure 4. Forward Voltage

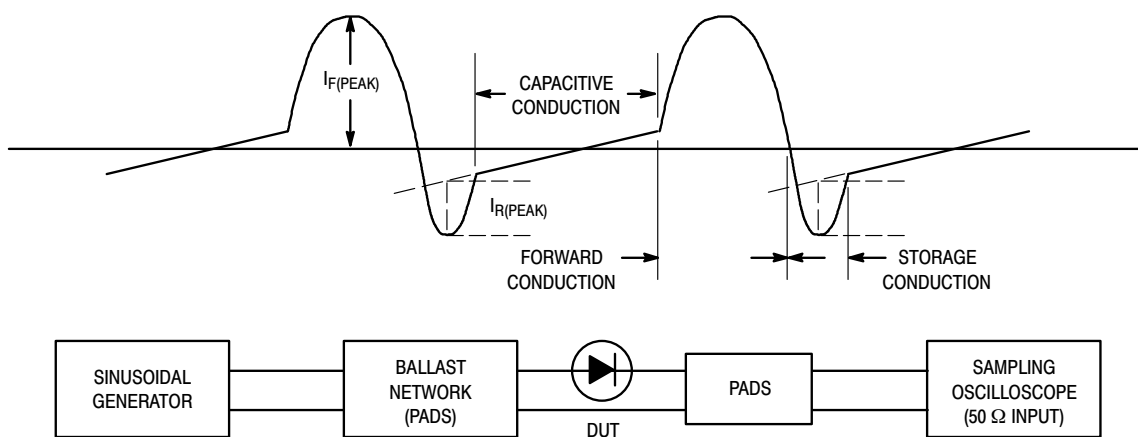

Figure 5. Krakauer Method of Measuring Lifetime



Micro Commercial Components

Ordering Information :

Device	Packing
Part Number-TP	Tape&Reel: 3Kpcs/Reel

*****IMPORTANT NOTICE*****

Micro Commercial Components Corp. reserves the right to make changes without further notice to any product herein to make corrections, modifications , enhancements , improvements , or other changes . **Micro Commercial Components Corp .** does not assume any liability arising out of the application or use of any product described herein; neither does it convey any license under its patent rights ,nor the rights of others . The user of products in such applications shall assume all risks of such use and will agree to hold **Micro Commercial Components Corp .** and all the companies whose products are represented on our website, harmless against all damages.

*****LIFE SUPPORT*****

MCC's products are not authorized for use as critical components in life support devices or systems without the express written approval of Micro Commercial Components Corporation.

*****CUSTOMER AWARENESS*****

Counterfeiting of semiconductor parts is a growing problem in the industry. Micro Commercial Components (MCC) is taking strong measures to protect ourselves and our customers from the proliferation of counterfeit parts. MCC strongly encourages customers to purchase MCC parts either directly from MCC or from Authorized MCC Distributors who are listed by country on our web page cited below. Products customers buy either from MCC directly or from Authorized MCC Distributors are genuine parts, have full traceability, meet MCC's quality standards for handling and storage. **MCC will not provide any warranty coverage or other assistance for parts bought from Unauthorized Sources.** MCC is committed to combat this global problem and encourage our customers to do their part in stopping this practice by buying direct or from authorized distributors.

www.mccsemi.com