

International  
**IOR** Rectifier

31DQ09G  
 31DQ10G

SCHOTTKY RECTIFIER

3.3 Amp

$I_{F(AV)} = 3.3 \text{ Amp}$   
 $V_R = 90 - 100V$

#### Major Ratings and Characteristics

Characteristics	Values	Units
$I_{F(AV)}$ Rectangular waveform	3.3	A
$V_{RRM}$	90 - 100	V
$I_{FSM}$ @ $t_p = 5 \mu\text{s}$ sine	370	A
$V_F$ @ 3 Apk, $T_J = 25^\circ\text{C}$	0.85	V
$T_J$	-40 to 150	$^\circ\text{C}$

#### Description/ Features

The 31DQ..G axial leaded Schottky rectifier has been optimized for very low forward voltage drop, with moderate leakage. Typical applications are in switching power supplies, converters, free-wheeling diodes, and reverse battery protection.

- Low profile, axial leaded outline
- High purity, high temperature epoxy encapsulation for enhanced mechanical strength and moisture resistance
- Very low forward voltage drop
- High frequency operation
- Guard ring for enhanced ruggedness and long term reliability

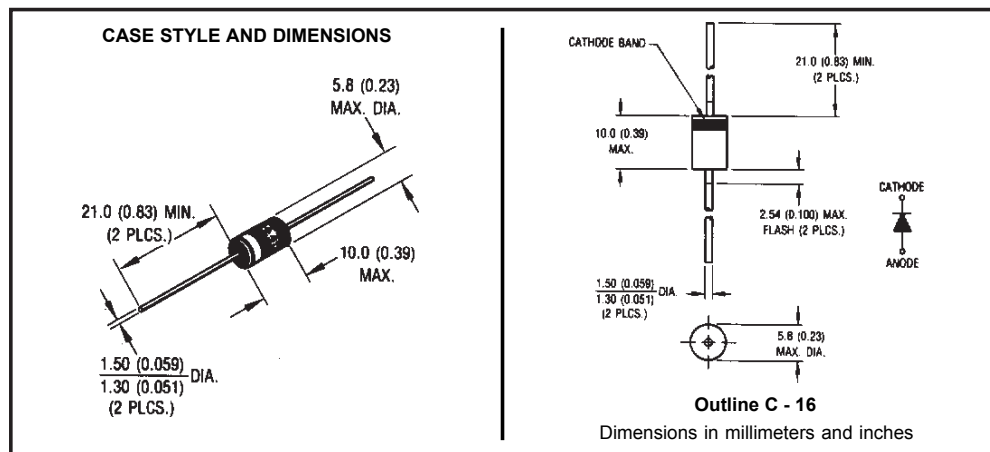

## Voltage Ratings

Part number	31DQ09G	31DQ10G
$V_R$ Max. DC Reverse Voltage (V)	90	100
$V_{RWM}$ Max. Working Peak Reverse Voltage (V)		

## Absolute Maximum Ratings

Parameters	31DQ..	Units	Conditions
$I_{F(AV)}$ Max. Average Forward Current * See Fig. 4	3.3	A	50% duty cycle @ $T_C = 53.4^\circ\text{C}$ , rectangular wave form
$I_{FSM}$ Max. Peak One Cycle Non-Repetitive Surge Current * See Fig. 6, $T_J = 25^\circ\text{C}$	370	A	Following any rated load condition and with rated $V_{RWM}$ applied
	60		
$E_{AS}$ Non-Repetitive Avalanche Energy	3.0	mJ	$T_J = 25^\circ\text{C}$ , $I_{AS} = 1.0$ Amps, 18 $\mu\text{s}$ square pulse
$I_{AR}$ Repetitive Avalanche Current	0.5	A	Current decaying linearly to zero in 1 $\mu\text{sec}$ Frequency limited by $T_J$ max. $V_A = 1.5 \times V_R$ typical

## Electrical Specifications

Parameters	31DQ..	Units	Conditions
$V_{FM}$ Max. Forward Voltage Drop * See Fig. 1 (1)	0.85	V	@ 3A
	0.97	V	@ 6A
	0.69	V	@ 3A
	0.80	V	@ 6A
$I_{RM}$ Max. Reverse Leakage Current * See Fig. 2 (1)	0.1	mA	$T_J = 25^\circ\text{C}$
	3	mA	$T_J = 125^\circ\text{C}$
$C_T$ Typical Junction Capacitance	110	pF	$V_R = 5V_{DC}$ (test signal range 100Khz to 1Mhz) $25^\circ\text{C}$
$L_S$ Typical Series Inductance	9.0	nH	Measured lead to lead 5mm from package body
dv/dt Max. Voltage Rate of Change	10000	V/ $\mu\text{s}$	(Rated $V_R$ )

(1) Pulse Width < 300 $\mu\text{s}$ , Duty Cycle <2%

## Thermal-Mechanical Specifications

Parameters	31DQ..	Units	Conditions
$T_J$ Max. Junction Temperature Range	-40 to 150	$^\circ\text{C}$	
$T_{stg}$ Max. Storage Temperature Range	-40 to 150	$^\circ\text{C}$	
$R_{thJA}$ Max. Thermal Resistance Junction to Ambient	80	$^\circ\text{C}/\text{W}$	DC operation Without cooling fins
$R_{thJL}$ Typical Thermal Resistance Junction to Lead	34	$^\circ\text{C}/\text{W}$	DC operation
wt Approximate Weight	1.2 (0.042)	g (oz.)	
Case Style	C - 16		
Marking Device	31DQ10G		

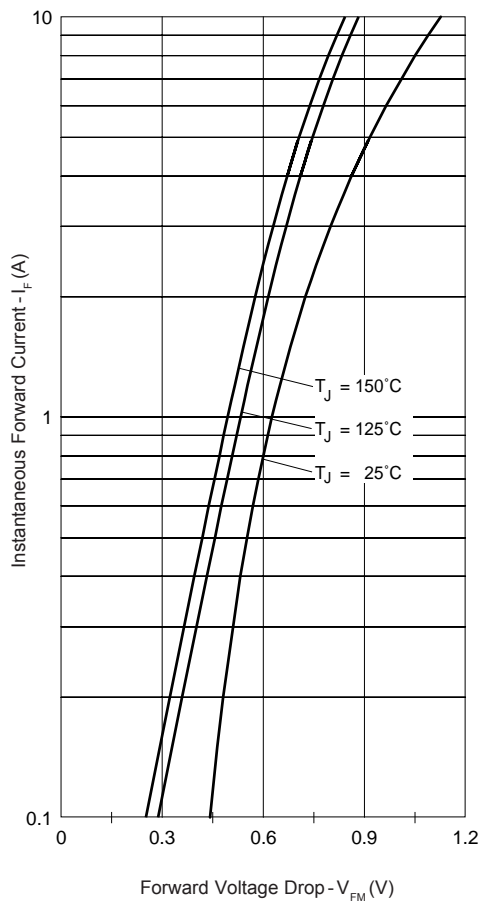

Fig. 1 - Max. Forward Voltage Drop Characteristics

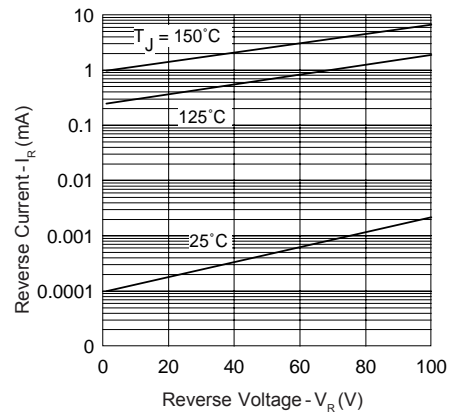

Fig. 2 - Typical Values Of Reverse Current Vs. Reverse Voltage

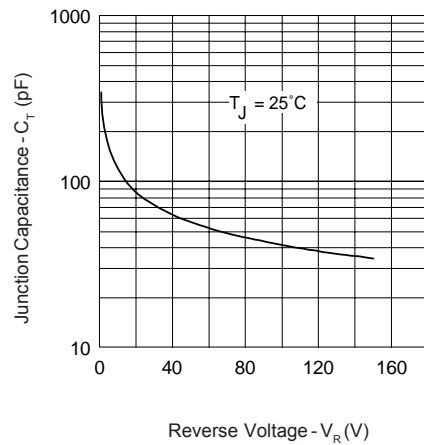
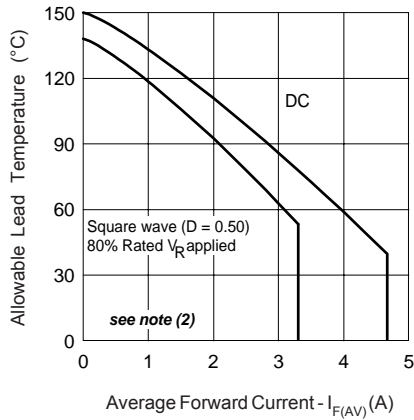
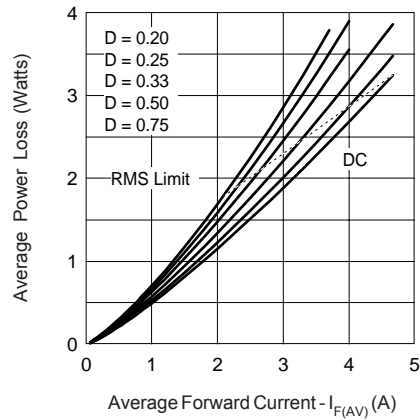

Fig. 3 - Typical Junction Capacitance Vs. Reverse Voltage



**Fig. 4 - Max. Allowable Lead Temperature Vs. Average Forward Current**



**Fig. 5 - Forward Power Loss Characteristics**

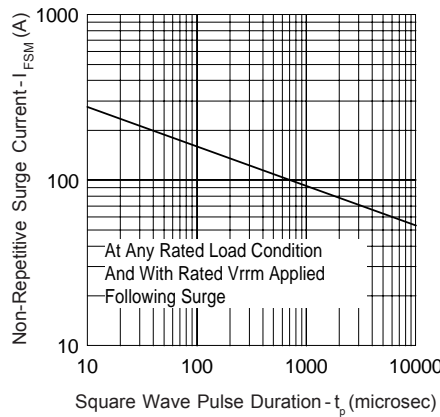

**Fig. 6 - Max. Non-Repetitive Surge Current**

(2) Formula used:  $T_c = T_j - (Pd + Pd_{REV}) \times R_{thJC}$ ;  
 $Pd = \text{Forward Power Loss} = I_{F(AV)} \times V_{FM} @ (I_{F(AV)} / D)$  (see Fig. 6);  
 $Pd_{REV} = \text{Inverse Power Loss} = V_{R1} \times I_R (1 - D); I_R @ V_{R1} = 80\% \text{ rated } V_R$

Ordering Information Table

Device Code						
31	D	Q	10	G	TR	-
①	②	③	④	⑤	⑥	⑦

<b>1</b>	-	31 = 3.3A (Axial and small packages - Current is x10)
<b>2</b>	-	D = DO-41 package
<b>3</b>	-	Q = Schottky Q.. Series
<b>4</b>	-	10 = Voltage Ratings
<b>5</b>	-	G = Schottky Generation
<b>6</b>	-	<ul style="list-style-type: none"> <li>• None = Box (500 pieces)</li> <li>• TR = Tape &amp; Reel (1200 pieces)</li> </ul>
<b>7</b>	-	<ul style="list-style-type: none"> <li>• none = Standard Production</li> <li>• PbF = Lead-Free</li> </ul>

10 = 100V  
09 = 90V

```

31DQ10
*****
* SPICE Model Diode *
*****
.SUBCKT 31DQ10 ANO CAT
D1 ANO 1 CAT
*Define diode model
.MODEL DMOD D(Is=56.46E-06 N=2.202 Rs=28.27E-03 Ikf=0.5957 Xti=2 Eg=1.11
+          Cjo=199.3E-12 M=0.4572 Vj=1.873 Fc=0.5 Isr=165.6E-24 Nr=4.955
+          Bv=119.9 Ibv=215.5E-06 Tt=21.64E-09)
*****
.ENDS 31DQ10
    
```

Data and specifications subject to change without notice.  
 This product has been designed and qualified for Industrial Level.  
 Qualification Standards can be found on IR's Web site.



## Notice

The products described herein were acquired by Vishay Intertechnology, Inc., as part of its acquisition of International Rectifier's Power Control Systems (PCS) business, which closed in April 2007. Specifications of the products displayed herein are pending review by Vishay and are subject to the terms and conditions shown below.

Specifications of the products displayed herein are subject to change without notice. Vishay Intertechnology, Inc., or anyone on its behalf, assumes no responsibility or liability for any errors or inaccuracies.

Information contained herein is intended to provide a product description only. No license, express or implied, by estoppel or otherwise, to any intellectual property rights is granted by this document. Except as provided in Vishay's terms and conditions of sale for such products, Vishay assumes no liability whatsoever, and disclaims any express or implied warranty, relating to sale and/or use of Vishay products including liability or warranties relating to fitness for a particular purpose, merchantability, or infringement of any patent, copyright, or other intellectual property right.

The products shown herein are not designed for use in medical, life-saving, or life-sustaining applications. Customers using or selling these products for use in such applications do so at their own risk and agree to fully indemnify Vishay for any damages resulting from such improper use or sale.

International Rectifier®, IR®, the IR logo, HEXFET®, HEXSense®, HEXDIP®, DOL®, INTERO®, and POWIRTRAIN® are registered trademarks of International Rectifier Corporation in the U.S. and other countries. All other product names noted herein may be trademarks of their respective owners.