

**Instruction Manual
for**

**Models 5360
5370
5380
5390**

**Premium Handheld
DIGITAL MULTIMETERS**



TABLE OF CONTENTS

| | page | | page |
|--|--------------------|---|------|
| TEST INSTRUMENT SAFETY | inside front cover | CAPACITANCE MEASUREMENTS | 17 |
| FEATURES | 3 | FREQUENCY MEASUREMENTS | 17 |
| CONTROLS AND INDICATORS | 5 | SELECTING IMPEDANCE FOR dBm AND RESISTIVE POWER MEASUREMENTS | 18 |
| OPERATING INSTRUCTIONS | 12 | dBm MEASUREMENTS | 18 |
| POWER ON / OFF | 12 | RESISTIVE POWER MEASUREMENT | 19 |
| PROGRAMMABLE POWERUP OPTIONS | 12 | DUTY CYCLE MEASUREMENTS | 19 |
| FUNCTION SELECTION | 13 | PULSE WIDTH MEASUREMENTS | 19 |
| RANGE SELECTION | 13 | PULSE COUNT MEASUREMENTS | 20 |
| ANALOG BARGRAPH, ZOOM | 13 | POWER DISTURBANCE INDICATION | 20 |
| BACKLIGHT | 14 | TEMPERATURE MEASUREMENT | 20 |
| HOLD & AUTO MEM MODE (AUTOSTORE) | 14 | MAINTENANCE | 21 |
| RELATIVE MEASUREMENTS | 14 | INSTRUMENT REPAIR SERVICE | 22 |
| PEAK HOLD MEASUREMENTS | 14 | SPECIFICATIONS | 23 |
| SURV or MIN / MAX / AVG MODE | 15 | ACCESSORIES | 28 |
| VOLTAGE MEASUREMENTS | 15 | CUSTOMER SUPPORT | 29 |
| CURRENT MEASUREMENTS | 15 | WARRANTY SERVICE INSTRUCTIONS | 30 |
| RESISTANCE MEASUREMENTS | 16 | LIMITED THREE-YEAR WARRANTY | 31 |
| CONTINUITY MEASUREMENTS | 16 | | |
| DIODE TESTING | 16 | | |

FEATURES

The **B+K Precision** Model 5390 is a highly accurate handheld digital multimeter with a multitude of highly advanced features. It is capable of taking the following measurements:

- ac voltages with ac (or rms) capacitive coupling
- ac voltages with ac + dc (or trms) direct coupling
- dc voltages
- ac current with ac (or rms) capacitive coupling
- ac current with ac + dc (or trms) direct coupling
- dc current
- Resistance
- Continuity
- Capacitance
- Diode threshold voltage
- Frequency
- Duty cycle
- Pulse width
- Pulse count
- dBm
- Resistive power

Features of the 5390 include:

- 0.025% DCV
- 0.07% Ohms
- 100 kHz ac response
- Autoranging, bargraph, and zoom
- Capacitance to 50,000 μ F
- Frequency, duty cycle, pulse width
- dB across 1 Ω to 10 k Ω
- VA across 1 Ω to 10 K Ω
- Power disturbance indicator
- Min/Max/Avg

Model 5380 has the same accuracy as the 5390 and most of the measurement capabilities. It does not include the 5390's power disturbance indicator, zoom bargraph, pulse width, duty cycle, event counting, and VA measurement. It measures dB across 600 Ω only.

Model 5370 has the same accuracy as the 5390 for all functions except dc volts. It includes all of the measurement capabilities as the 5390 except for pulse width, event counting, and VA measurement. It also is capable of temperature measurement within 0.5 $^{\circ}$ C using a platinum probe.

Model 5360 has the capability of taking many of the same measurements as the 5380, but at a lower accuracy. Its measurement capabilities do not include dBm, but does include duty cycle.

FEATURES

All models include 50,000 count resolution, true rms (ac or ac + dc) built-in RS-232 capability, standard Certificate of Calibration, ASYC[®] II (Advanced Safety Concept) design with IEC1010, IP677, and MIL-T-28800 compliance, a splash-proof sealed case, and a three-year warranty.

The standard SECURX test lead retainers, designed to work with shouldered test leads, ensure that the test leads will not be pulled out accidentally.

The display features clearly legible 14 mm (0.55 inch) high figures. All models except 5360 feature a backlit display.

Refer to the SPECIFICATION section of this manual for complete specifications for each of the models.

Refer to the ACCESSORIES section of this manual for a description of each of the standard and optional accessories for the multimeters.

CONTROLS AND INDICATORS

Figures 1 through 4 illustrate each of the multimeters. Refer to the illustrations while reviewing the following descriptions of each of the controls.

NOTE

Throughout this section of the manual, instructions include short and long presses of buttons on the multimeter. A short press means less than one second and a long press means greater than one second.

1. **Display.** 50,000 count LCD display with 14 mm (0.55") high digits, automatic decimal point, minus sign and 34 segment bar graph. Indicates 5,000 counts in low resolution mode. Annunciators for all functions, units of measurement, blown fuse and for low battery. Overrange indicated by OL. Refer to Fig. 12 and the associated text for detailed description of the display.
2. **Hz Button** (5370 and 5390 only). Enables frequency functions when rotary **Function Switch** (7) is set to VAC, VDC, mVDC, mA DC and 10ADC. Short presses engage frequency measurement, % positive duty cycle, % negative duty cycle, positive pulse count, negative pulse count, positive pulse width measurement, negative pulse width measurement, and back to original rotary **Function Switch** (7) setting. A long press at any time returns the unit back to its original rotary **Function Switch** setting.
3. **SURV Button** (5370, and 5390 only). Enables the SURVEILLANCE or MIN, MAX, AVG recording mode. A long press enables or disables the recording mode. Short presses display current values of MIN, MAX, or AVG measurements. The symbols flash with selected modes. The values are stored when the SURV mode is disabled or when the unit power is switched OFF. Short presses allow the MIN, MAX, AVG values to be read. A long press enables the SURV mode and clears the previous values.
4. **☼ Button** (5370, 5380, and 5390 only). Turns the backlight of the LCD display on and off. The backlight turns off automatically after about 30 seconds.
5. **HOLD Button.** Toggles the data hold feature on and off for all functions, and enables the AUTO MEM MODE. A short press freezes the current reading on the display with the MEM annunciator on. Another short press releases the display. A long press enables the AUTO MEM MODE only in the VDC, mVDC, and VAC positions of the rotary **Function Switch** (7).
6. **PK +/- Button.** Enables the fast peak hold (positive and negative) capability when the rotary **Function Switch** (7) is set to VDC, mVDC, mA DC, and 10ADC functions.
7. **Function Switch.** Rotary switch, selects function for AUTO ranging modes; selects function and some ranges for current modes. Primary function selected is indicated by white labeling of the switch position. The secondary function of each position is labeled in yellow and is activated by the yellow **SEL/ON** button as shown in Figures 6 through 11.

CONTROLS AND INDICATORS

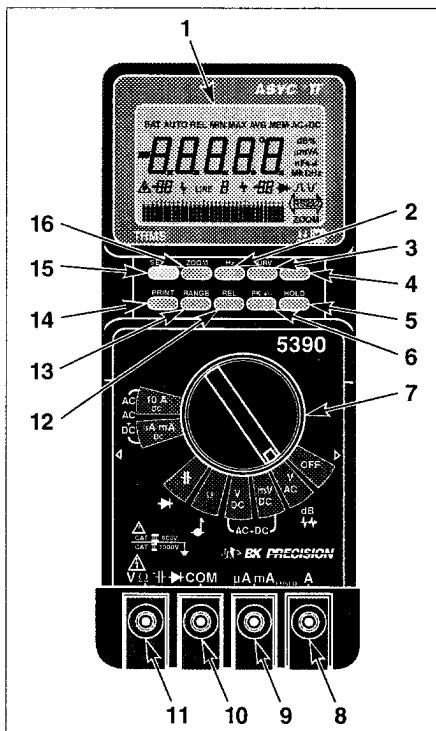

Fig. 1 Model 5390 Controls

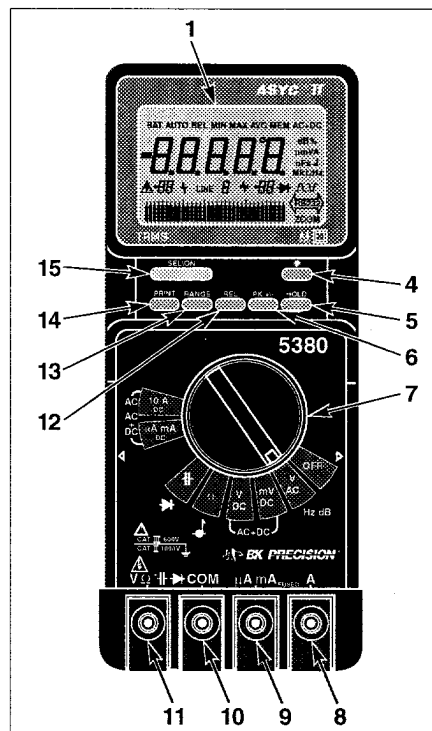

Fig. 2 Model 5380 Controls

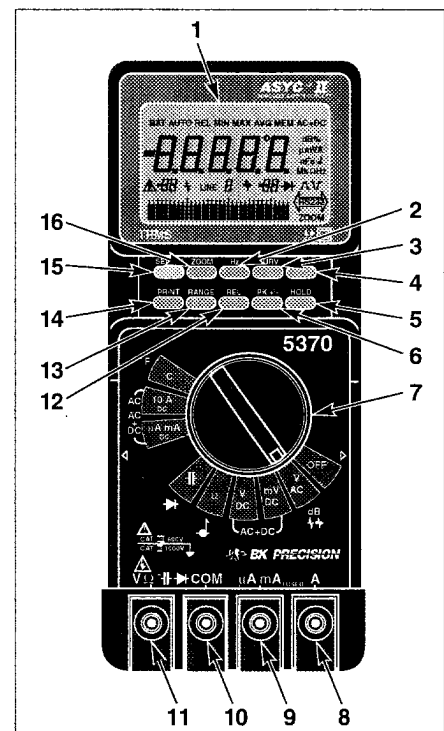

Fig. 3 Model 5370 Controls

CONTROLS AND INDICATORS

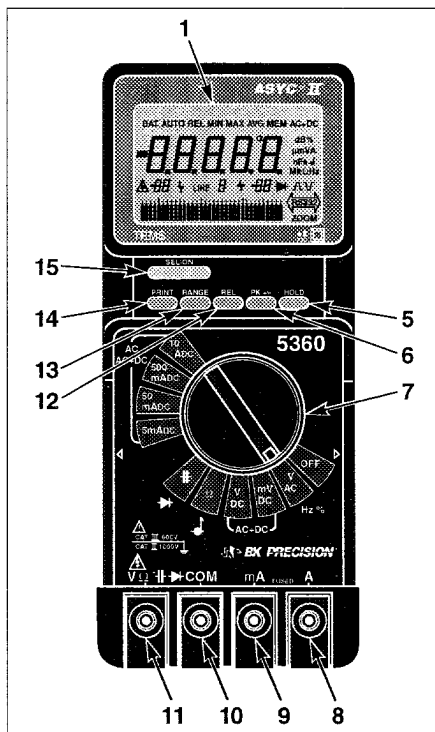

Fig. 4 Model 5360 Controls

8. **A Jack**. Input for 10 A DC, AC, or DC+AC current range.
9. **μA mA Jack**. Input for DC, AC, or AC+DC currents up to 500 mA.
10. **COM Jack**. Input for common or reference test lead for all measurements.
11. **V Ω ∩ → Jack**. Input for DC, AC, and AC+DC Volts, capacitance, diode test, resistance, continuity, or frequency functions.
12. **REL Button**. Sets initial reading as the zero reference for making relative measurements. A short press enables the mode and sets the display to zero. Another short press disables the mode and returns the unit back to its normal mode. When in the REL mode, a long press displays the reference being used. The reference value may then be adjusted using the **SEL/ON** and **RANGE** buttons. The **SEL/ON** button is used to select the digits and the sign, while the **RANGE** button is used to increment the selected digit. A short press returns the unit to the REL measurement mode. Another short press returns the unit back to its normal mode.
13. **RANGE Button**. Manual ranging selector switch. A short press changes from the AUTO mode to MANUAL mode. Subsequent short presses advance range selection to the next higher range until the highest range is reached, then advances to the lowest range. A long press at any time returns the unit back to the AUTO ranging mode.
14. **PRINT Button**. Turns on the RS232 port and sends a measurement to the printer. A short press sends one measurement. A long press allows the user to define the rate at which the measurements are sent from 00000 sec (a single transmission) up to 9 hr, 59 min, 59 sec. The **SEL/ON** button is used to select the digits, while the **RANGE** button is used to increment the selected digit. A short press returns the unit to the PRINT mode. Another short press returns the unit to the normal mode.
15. **SEL/ON Button** (yellow). Selects the secondary functions of the rotary **Function Switch** (7) indicated in yellow. Toggles between DC, AC, and AC+DC for current measurements; toggles

CONTROLS AND INDICATORS

between capacitance and diode testing; toggles between ohms and continuity checking; toggles between DC and AC+DC voltage measurements; or toggles between AC voltage and dB/Hz measurements. Also used to turn on the multimeter after an automatic shutdown.

- ZOOM Button** (5370 and 5390 only). Expands the scale of the 34 segment analog bargraph by a factor of five for positive measurements and a factor of 11 for bipolar measurements.

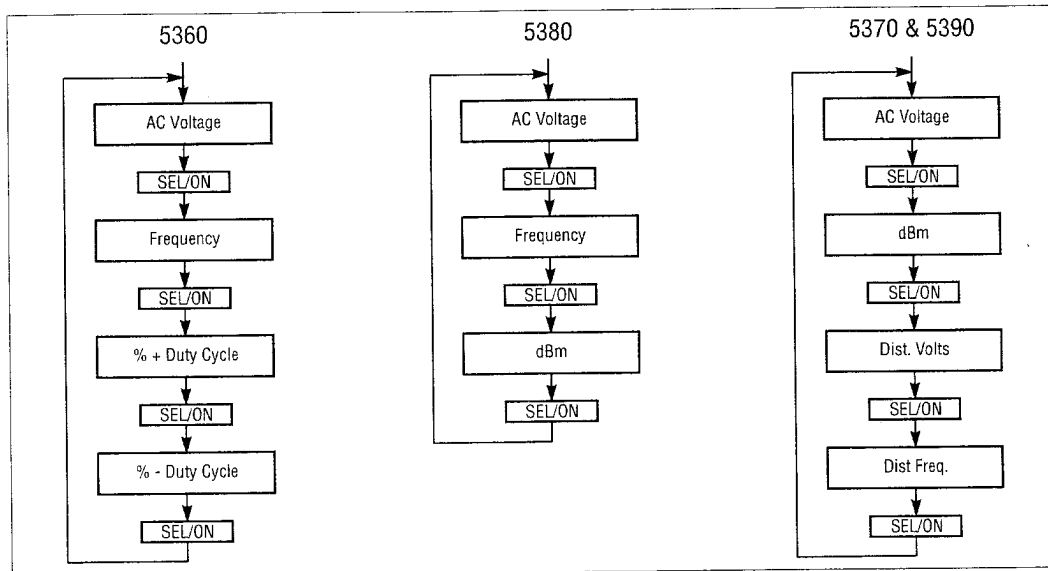

Fig. 5 VAC Position

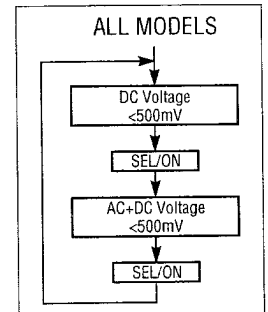

Fig. 6 mVDC Position

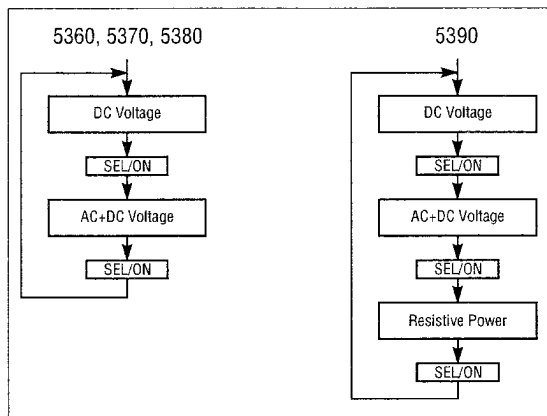

Fig. 7 VDC Position

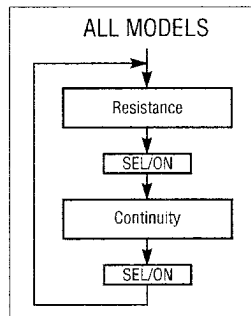

Fig. 8 Ω Position

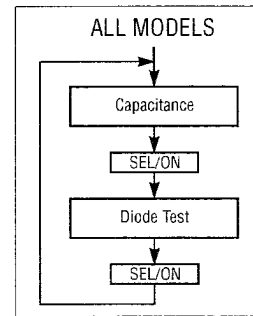

Fig. 9 H-Position

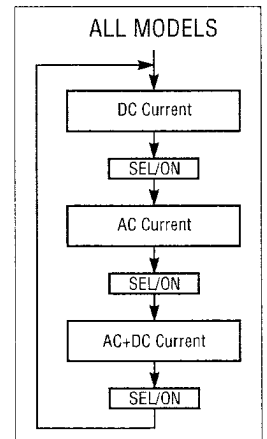

Fig. 10 μA, mA, 10A Position

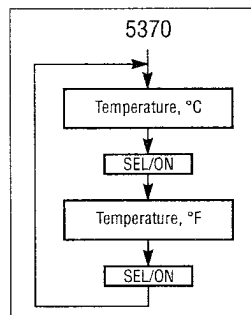

Fig. 11 °C Position

CONTROLS AND INDICATORS

LCD INDICATORS

Figure 12 shows all the annunciators on the LCD display. Refer to this illustration while reviewing the following descriptions.

1. **BAT** indicates low battery. When the BAT symbol first appears the battery has approximately 10% (50 hours) of life remaining.
2. **AUTO** indicates that the instrument is in AUTO ranging mode. This is the standard mode for measurements that have more than one range.
3. **REL** illuminates when the instrument is set to the relative mode (short press of the REL button).
4. **MIN MAX AVG** illuminates when the instrument is placed in surveillance mode (long press of the SURV button). Each annunciator flashes when the meter displays the particular value (short press of the SURV button).
5. **MEM** flashes to signify that the instrument has been placed in the autostore mode (long press of the HOLD button).
6. **AC+DC** illuminates when the instrument is set to take AC+DC voltage or current measurements. **AC** illuminates when the instrument is set to take AC voltage or current measurements.
7. **dB** illuminates when the instrument is set to take dBm measurements (5370, 5380 and 5390).
8. **%** illuminates when the instrument is set to take duty cycle measurements (5370, 5380 and 5390).
9. **VA** illuminates when the instrument is set to take resistive power measurements (5390 only). The **A** illuminates alone when the instrument is set to take current measurements and the **V** illuminates alone for voltage measurements.

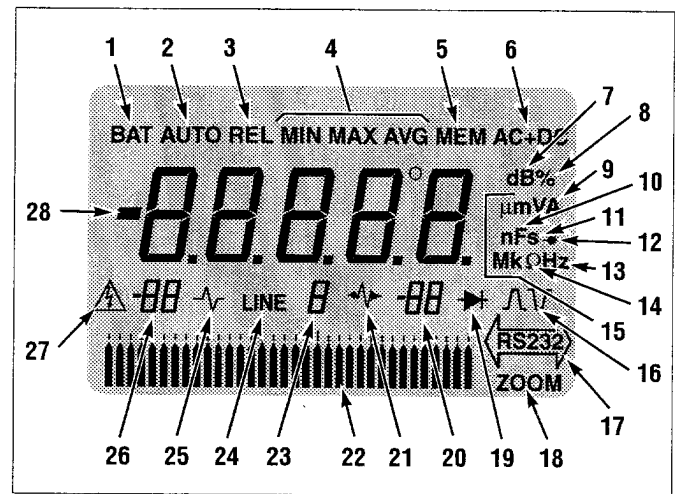







Fig. 12 LCD Display

10. **F** illuminates when the instrument is set to take capacitance measurements.
11. **s** illuminates when the instrument is set to take pulse width measurements.
12. **♪** illuminates when the instrument is set to check continuity.
13. **Hz** illuminates when the instrument is set to take frequency measurements.

CONTROLS AND INDICATORS

14. Ω illuminates when the instrument is set to take resistance measurements.
15. **Unit range.** The following annunciators illuminate to signify the units of measure being displayed. They are displayed with the particular unit of measure, for example $M\Omega$ for Megohm and μA for microamp.
 - n** represents nano (10^{-9})
 - μ represents micro (10^{-6})
 - m** represents milli (10^{-3})
 - k** represents kilo (10^3)
 - M** represents Mega (10^6)
16. $\wedge \vee$ Pulses illuminates when the instrument is set to take duty cycle, pulse width, and pulse count measurements. \wedge signifies positive pulses and \vee signifies negative pulses.
17.  illuminates when the RS232 port is active. The port is active during a print function or when the instrument is connected to a computer using the **B+K Precision** Model 5300 Calibration Kit or Model 5350 Data Acquisition Kit.
18. **ZOOM** illuminates to signify that the bargraph scale has been expanded. The left and right bargraph scale indicators display the range of the bargraph.
19.  illuminates when the instrument is set to test diodes.
20. **Right bargraph scale** displays the units for the bargraph at the right end of the scale.
21.  (Harmonic disturbance) illuminates when the instrument is set to take power disturbance measurements. Three bars of the bargraph directly beneath the annunciator illuminate when a harmonic disturbance greater than 25 V is measured during power disturbance testing.
22. **Bargraph.** The 34-segment bargraph provides an analog display of the value.
23. **Centered Zero.** displays when the unit is set for bipolar measurement, indicating the zero position on the bargraph.
24. **LINE** illuminates when the instrument is set to take power disturbance measurements.
25.  (Transient disturbance) illuminates when the instrument is set to take power disturbance measurements. Three bars of the bargraph directly beneath the annunciator illuminate when a transient disturbance greater than 80 V is measured during power disturbance testing.
26. **Left bargraph scale** displays the units for the bargraph at the left end of the scale.
27.  (Dangerous voltage) annunciator illuminates to alert the operator that the instrument is measuring voltages greater than 24 V.
28. **Value display.** The 14 mm high digits display the value of the measurement being taken. A - (minus sign) signifies a negative value. Positive values are implied and a positive sign is not displayed. The \circ indicator to the left of the last digit signifies temperature measurement (5370 only). The last digit displays a C for Celsius or F for Fahrenheit during temperature measurements.

OPERATING INSTRUCTIONS

WARNING

Use of test equipment may expose the operator to electric shock hazards. Observe all instructions contained in the TEST INSTRUMENT SAFETY section of this manual before using this instrument.

CAUTION

The TEST INSTRUMENT SAFETY section of this manual lists maximum voltage and current input limits which must be observed. Failure to adhere to these limits may result in damage to the INSTRUMENT.

NOTE

Throughout this section of the manual, instructions include short and long presses of buttons on the multimeter. A short press means less than one second and a long press means greater than one second.

POWER ON / OFF

Turn the unit on by rotating the **Function Switch** clockwise to the desired function. All the LCD display segments come on for a few seconds, then only the appropriate annunciators for the selected function stay on.

Turn the unit off by rotating the **Function Switch** to the OFF position. The AUTO POWER OFF feature prolongs battery life by automatically shutting off the unit after approximately half an hour if no switch is operated. To turn on the unit after an AUTO POWER OFF, press the yellow **SEL/ON** button.

NOTES

The AUTO POWER OFF feature is disabled when the unit is set to the **SURV, PK +/-**, pulse counting, and data print modes.

For user safety, the AUTO POWER OFF is also disabled when a dangerous voltage is present at the input jacks. The  indicator illuminates to signify the condition.

PROGRAMMABLE POWERUP OPTIONS

There are several operating modes that can be selected upon powerup. Typically, these modes are infrequently changed and are stored in non-volatile memory so that the selection is retained until reprogrammed.

1. **50 Hz** or **60 Hz** rejection.

Hold down the **HOLD** button and set the rotary **Function Switch** to the appropriate position. The selection reverses the previous setting, is displayed for two seconds, and is stored in non-volatile memory.

2. **10MΩ / 1000MΩ** input impedance for the mV range. (5370, 5380 and 5390 only).

Hold down the **RANGE** button and set the rotary **Function Switch** to the appropriate position. The selection reverses the previous setting, is displayed for two seconds, and is stored in non-volatile memory.

3. **5,000**-count low-resolution mode.

Hold down the **REL** button and set the rotary **Function Switch** to the appropriate position. The display shows 5,000 for two seconds.

NOTE

The low resolution mode is not stored in non-volatile memory. If the unit is turned on after an AUTO POWER OFF with the **SEL/ON** button, the unit powers up in the normal 50,000 count-high-resolution mode.

4. **RS232** operation.

Hold down the **PK +/-** button and set the rotary **Function Switch** to the appropriate position. The display shows the RS232 indicator for two seconds. The RS232 mode is not stored in non-volatile memory.

FUNCTION SELECTION

The rotary **Function Switch** selects the primary function such as **VAC**, **mVDC**, **VDC**, Ω , -- . All the **Function Switch** positions are dual or multi-functional with the primary function for each position indicated by WHITE labeling. The secondary functions for each position are indicated with YELLOW labeling, and are accessed with a press of the yellow **SEL/ON** button. For example, when the rotary Function is set to the **10ADC** position, the DC current function is selected. A press of the yellow **SEL/ON** button puts the unit into the 10A AC (RMS) position, ready to measure AC cur-

rents with capacitive coupling. The AC annunciator illuminates on the LCD display. A second press of the **SEL/ON** button puts the unit into the 10A AC+DC (TRMS) position, ready to measure AC currents with direct coupling. The AC+DC annunciator illuminates on the LCD display. A third press of the **SEL/ON** button returns the unit back to the primary 10ADC function.

RANGE SELECTION

1. The AUTO ranging mode is automatically selected when the unit is turned on and whenever the rotary **Function Switch** is set to a new position (does not apply to single range functions such as mVDC, 10ADC or all the current ranges of the 5360).
2. A short press of the **RANGE** button changes the instrument to the MANUAL ranging mode. The AUTO annunciator of the LCD display turns off confirming the action. A short press advances the unit to the next higher range. Subsequent short presses advances the unit until the highest range is reached, then the next short press advances the unit to the lowest range.
3. A long press of the **RANGE** button at any time returns the unit to the AUTO ranging mode.
4. If the quantity to be measured is unknown, start with the highest range in the MANUAL mode, or use the AUTO ranging mode.
5. When an overrange is indicated (OL and beep), switch to the next higher range or until an on-scale measurement can be taken.

ANALOG BARGRAPH, ZOOM

The 34 segment analog bargraph feature is activated for measurements of voltage, current, resistance, frequency, and capacitance. Its update speed of 20 measurements/second is 10 times that of the digital display. This

OPERATING INSTRUCTIONS

makes it suitable for measuring coarse adjustments of these parameters or indicating the direction of change of a varying quantity.

The ZOOM feature (5370 and 5390 only) expands the scale of bargraph around the measured digital reading to greatly enhance viewing fast changes. A short press of the **ZOOM** button increases this scale. Subsequent short presses keep expanding this scale until it returns back to its original full scale value. A long press of the **ZOOM** button at any time returns the bargraph back to full scale.

BACKLIGHT (5370, 5380 and 5390 only)

LCD displays work by reflecting light. As less ambient light is available, there is less apparent contrast between the LCD digits and the background, and it becomes more difficult to view the display. The backlight feature is useful in low ambient light conditions. A short press of the backlight (☀️) button turns on the display backlight. A second short press immediately turns off the backlight. If the multimeter is not being used, the backlight turns off automatically after about 30 seconds.

HOLD & AUTO MEM MODE (AUTOSTORE)

The **HOLD** button allows the user to freeze the current display or enable the AUTO MEM (Autostore) mode. A short press freezes the current display. A second short press releases the display.

The Autostore mode is used to obtain a stable voltage measurement when the user cannot look at the display and the measurement point simultaneously. Autostore is accessible in the **VDC**, **mVDC**, or **VAC** positions of the **Function Switch**.

1. A long press of the **HOLD** button sets the unit to the Autostore mode. The **MEM** annunciator flashes to confirm the selection.
2. Connect the test leads to the point to be measured. A beep indicates that the measurement is stable.

3. When the leads are removed from the test point, a second beep indicates that the reading has been stored, and the value can be viewed on the LCD display.
4. A second long press of the **HOLD** button returns the unit to its normal mode.

RELATIVE MEASUREMENTS

When the **REL** button is pressed, the present reading becomes the zero reference and all subsequent readings are displayed relative to this value. A second short press disables the mode and returns the unit back to its normal mode. When in the REL mode, a long press displays the reference being used. The reference value may then be adjusted using the **SEL/ON** and **RANGE** buttons. The **SEL/ON** button is used to select the digits and the sign, while the **RANGE** button is used to increment the selected digit. A short press of the **REL** button returns the unit to the relative measurement mode. Another short press returns the unit back to its normal mode.

PEAK HOLD MEASUREMENTS

Fast (<1 ms) positive and negative peak measurements can be made when the rotary **Function Switch** is set to **VDC**, **mVDC**, **mADC**, and **10ADC**. A short press of the **PK +/-** button puts the unit into the positive peak detection mode, and changes the unit from the AUTO ranging mode to the MANUAL ranging mode, locking the unit on the range. If the potential peak is greater than full scale of the selected range, use the **RANGE** button to set the unit to the next higher range, or until an on-scale measurement is possible. The \wedge annunciator of the LCD display confirms the selection. If a negative peak detection is anticipated, press the **PK +/-** button a second time. The \vee annunciator of the LCD display confirms the selection. To return the unit back to its normal mode, press the **PK +/-** button again.

SURV or MIN / MAX / AVG MODE (5370 and 5390 only)

The surveillance mode is useful for recording the variation of the quantity (voltage, current, resistance, capacitance, etc.) being measured by the unit. Activation of the SURV mode locks the unit into its present range and deactivates the AUTO POWER OFF feature. If the unit is in the AUTO ranging mode, it changes to the MANUAL ranging mode. A long press of the **SURV** button enables or disables the recording mode. Short presses display current values of MIN, MAX, or AVG measurements. The annunciators flash with each selection.

The measurements are stored even when the SURV mode is disabled or the unit power is shut OFF. Short presses of the **SURV** button allow the MIN, MAX, or AVG values to be viewed. A long press enables the SURV mode and clears the previous values.

VOLTAGE MEASUREMENTS (AC, DC, AC+DC)

1. To measure DC voltage, set the rotary **Function Switch** to the VDC position. If the voltage is known to be less than 500 mV, the **Function Switch** may be set to mVDC.
2. To measure AC+DC (TRMS) voltage with direct coupling, press the yellow **SEL/ON** button with the rotary **Function Switch** in the VDC position.
3. To measure AC (RMS) voltage with capacitive coupling, set the rotary **Function Switch** to the VAC position.
4. Connect the red test lead to the $V \Omega \text{ } \overline{\text{H}} \text{ } \blacktriangleright$ jack and the black test lead to the **COM** jack.

NOTE

The SECURX adapter for the input jacks locks the test leads securely so that they cannot accidentally be pulled out. To release a test lead, push the SECURX locking bar toward the LCD display and hold it while the test leads are pulled out.

5. Connect the test leads to points of measurement.
6. For DC measurements, a (–) sign is displayed for negative polarity; (+) positive polarity is implied and is not displayed. The V annunciator is displayed.
7. For AC measurements, the AC annunciator is displayed, and for AC+DC measurements, the AC+DC annunciator is displayed.

CURRENT MEASUREMENTS (AC, DC, AC+DC)

For current measurements, the meter must be connected in series with the load. If incorrectly connected (in parallel with the load), the meter presents a very low impedance (almost a short), which may blow the fuse or damage the meter or equipment under test.

1. To measure DC current, set the rotary **Function Switch** to the desired **mADC** or **10ADC** position.
2. For current measurements under 500 mA, connect the red test lead to the **mA** jack and the black test lead to the **COM** jack. For current measurements over 500 mA, connect the red test lead to the **A** jack and the black test lead to the **COM** jack.

OPERATING INSTRUCTIONS

3. To measure AC (RMS) current with capacitive coupling, ensure that the **Function Switch** in the **mADC** or **10ADC** position and press the yellow **SEL/ON** button once. The **AC** annunciator illuminates.
4. To measure AC+DC (TRMS) current with direct coupling, ensure that the **Function Switch** is in the **mADC** or **10ADC** position, and press the yellow **SEL/ON** button a second time. The **AC+DC** annunciator illuminates.
5. Remove power from the circuit under test and open the normal circuit path where the measurement is to be taken. Connect the meter in series with the circuit.
6. Apply power and read the value from the display.

RESISTANCE MEASUREMENTS

WARNING

To ensure operator safety, never connect leads to a live circuit when taking resistance measurements.

1. To measure resistance, set the **Function Switch** to the Ω position.
2. Connect the red test lead to the **V Ω \rightarrow** jack and the black test lead to the **COM** jack.
3. Connect the test leads to points of measurement.
4. For highest accuracy when measuring low resistance, press the **RANGE** button to set the unit to the 500 range, short the test leads together, and press the **REL** button. This zeros the meter to compensate for the resistance of the test leads.

CONTINUITY MEASUREMENTS

WARNING

To ensure operator safety, never connect leads to a live circuit when taking resistance measurements.

1. To measure continuity, set the **Function Switch** to the Ω position, and then press the yellow **SEL/ON** button. The \rightarrow annunciator illuminates.
2. Connect the red test lead to the **V Ω \rightarrow** jack and the black test lead to the **COM** jack.
3. Connect the test leads to points of measurement. The buzzer sounds when the resistance is less than approximately 20 Ω .

DIODE TESTING

1. Set the **Function Switch** to the \rightarrow (capacitance) position, and then press the yellow **SEL/ON** button. The \rightarrow annunciator illuminates.
2. Connect the red test lead to the **V Ω \rightarrow** jack and the black test lead to the **COM** jack. The red lead is (+) positive polarity.
3. To check forward voltage (V_f), connect the red lead to the anode and the black lead to the cathode. Diodes and semiconductor junctions with normal V_f of less than approximately 2 V can be checked.
4. The display indicates the forward voltage. Normal diode voltages are approximately 0.3–0.4 V for germanium diodes, 0.6–0.7 V for silicon diodes, and 1.6 V for light emitting diodes (LED). A shorted diode reads near 0 V. An open diode reads the same as with open leads.
5. Reverse the test lead connections to the diode. The reading should be the same as with open test leads. A lower reading indicates a leaky diode.

CAPACITANCE MEASUREMENTS

WARNING

Discharge all capacitors before taking any measurements. Damage to the instrument and injury to the operator could occur. To ensure operator safety, never connect the leads to a live circuit.

1. Set the **Function Switch** to the $\text{--}\text{||}\text{--}$ (capacitance) position.
2. Connect the red test lead to the $\text{V}\Omega\text{--}\text{||}\text{--}$ jack and the black test lead to the **COM** jack.
3. Connect the test leads to the capacitor. Observe polarity when measuring polarized capacitors, the red lead is (+) positive polarity.
4. Read the capacitance from the display. A shorted capacitor will indicate an overrange. An open capacitor will indicate near zero on all ranges.
5. For maximum accuracy, press the **RANGE** button to step to the desired range in MANUAL ranging, then press the **REL** button to zero the test lead capacitance before taking measurements. Always use the **REL** button for readings in the 50 nF range.

USEFUL CONVERSIONS

| pF | nF | μF |
|-----------|-----------|---------------|
| 1,000 | 1.0 | 0.001 |
| 10,000 | 10.0 | 0.01 |
| 100,000 | 100.0 | 0.1 |
| 1,000,000 | 1,000.0 | 1.0 |
| | 10,000.0 | 10.0 |
| | 100,000.0 | 100.0 |

pF = picofarads (10^{-12})

nF = nanofarads (10^{-9})

μF = microfarads (10^{-6})

FREQUENCY MEASUREMENTS

Frequency measurement may be made when taking voltage measurements for all multimeters, and for the 5390 and 5370, while taking current measurements as well.

NOTE

Connect the red test lead to the appropriate current input jack if the **Function Switch** is set to mADC or 10ADC on the models 5370 and 5390.

1. Connect the red test lead to the $\text{V}\Omega\text{--}\text{||}\text{--}$ jack and the black test lead to the **COM** jack.
2. Connect the test leads to points of measurement.
3. To measure frequency with models 5360 and 5380, follow the procedure for taking voltage measurements. While the voltage measurement

OPERATING INSTRUCTIONS

is displayed, press the yellow **SEL/ON** button once. The frequency is then shown on the display.

4. To measure frequency with models 5370 and 5390, follow the procedure for taking voltage or current measurements. While the measurement is displayed, press the **Hz** button once. The frequency is then shown on the display.

SELECTING IMPEDANCE FOR dBm AND RESISTIVE POWER MEASUREMENTS (5370 and 5390 only)

The reference impedance for dBm and resistive power measurements is selectable from 1 Ω to 9999 Ω for models 5370 and 5390.

1. To select the reference impedance set the **Function Switch** to the **VAC** position, then long press the **ZOOM** button. The impedance reference is displayed.
2. Press the **SEL/ON** button once to select the digit to set.
3. Press the **RANGE** button to increment the selected digit.
4. Press the **SEL/ON** button again to select the next digit to set, and the **RANGE** button to increment digit.
5. When the reference impedance is set, short press the **ZOOM** button to return the unit to **VAC** mode.

dBm MEASUREMENTS (5370, 5380 and 5390 only)

NOTE

The reference impedance is fixed at 600 Ω for the 5380, and is adjustable for the 5370 and 5390. Refer to **SELECTING IMPEDANCE** to set the impedance for models 5370 and 5390.

1. To measure dB in the models 5370 and 5390, set the **Function Switch** to the **VAC** position, then press the **SEL/ON** button once. To measure dB in the model 5380, set the rotary **Function Switch** to the **VAC** position, and then press the yellow **SEL/ON** button twice.
2. Connect the red test lead to the **V Ω \rightarrow** jack and the black test lead to the **COM** jack.
3. Connect the test leads to points of measurement.
4. Read dB measurement from the display.

RESISTIVE POWER MEASUREMENT (5390 only)

NOTE

Refer to SELECTING IMPEDANCE to set the reference impedance before performing a resistive power measurement.

1. To measure resistive power in VA, set the **Function Switch** to the **VDC** position.
2. Connect the red test lead to the $V\Omega$ jack and the black test lead to the **COM** jack.
3. Press the **SEL/ON** button twice to measure power.
4. Connect the test leads to the measurement points.

DUTY CYCLE MEASUREMENTS (5360, 5370 and 5390 only)

Duty cycle measurements can be taken while voltage measurements are taken for all meters, and while current measurements are taken using the 5390 and 5370.

1. To measure % positive duty cycle in the model 5360, set the **Function Switch** to the **VAC** position, and then press the yellow **SEL/ON** button twice. To measure % negative duty cycle, press the yellow **SEL/ON** button a third time. To measure % positive duty cycle in the models 5370 and 5390, set the rotary **Function Switch** to **VAC**, **VDC**, **mVDC**, **mADC**, or **10ADC**, then press the **Hz** button twice. To measure % negative duty cycle, press the **Hz** button a third time.

2. To perform duty cycle measurements during current measurements (5370 and 5390 only), connect the red test lead to the appropriate current input jack and the black test lead to the **COM** jack.

or

to perform duty cycle measurements during voltage measurements, connect the red test lead to the $V\Omega$ jack and the black test lead to the **COM** jack.

3. Connect the test leads to points of measurement.
4. Read % positive or % negative duty cycle from the display. The % annunciator and either the Λ or ∇ annunciators indicate the polarity.

PULSE WIDTH MEASUREMENTS (5390 only)

Pulse width measurements can be taken while taking voltage or current measurements.

1. To measure positive width, set the rotary **Function Switch** to **VAC**, **VDC**, **mVDC**, **mADC**, or **10ADC**, then short press the **Hz** button six times. To measure negative pulse width, short press the **Hz** button a seventh time.
2. To perform pulse width measurements during current measurements, connect the red test lead to the appropriate current input jack and the black test lead to the **COM** jack.

or

to perform pulse count measurements during voltage measurements, connect the red test lead to the $V\Omega$ jack and the black test lead to the **COM** jack.

3. Connect the test leads to points of measurement.

OPERATING INSTRUCTIONS

4. Read positive or negative pulse width from the display. The Λ or ∇ annunciators of the LCD indicate the polarity.

PULSE COUNT MEASUREMENTS (5390 only)

Pulse count measurements can be taken while taking voltage or current measurements. This is a totaled pulse count from the time of activation until the time of reading.

1. To measure positive pulse count, set the **Function switch** to **VAC**, **VDC**, **mVDC**, **mADC**, or **10ADC**, then short press the **Hz** button four times. To measure negative pulse count, short press the **Hz** button a fifth time.
2. To perform pulse count measurements during current measurements, connect the red test lead to the appropriate current input jack and the black test lead to the **COM** jack,

or

to perform pulse count measurements during voltage measurements, connect the red test lead to the $V\Omega$ jack and the black test lead to the **COM** jack.
3. Connect the test leads to points of measurement.
4. Read positive or negative pulse counts from the display. The Λ or ∇ annunciators of the LCD indicate the polarity.

POWER DISTURBANCE INDICATION (5370 and 5390 only)

1. To measure the disturbances of the AC power lines, set the **Function Switch** to the **VAC** position. The **LINE** annunciator illuminates.
2. Connect the red test lead to the $V\Omega$ jack and the black test lead to the **COM** jack.

3. Connect the test leads to the AC power lines.
4. Press the **SEL/ON** button twice to detect a transient disturbance. Three bars of the bargraph directly beneath the annunciator illuminate if the disturbance is greater than 80 V.
5. Press the **SEL/ON** button a third time to detect a high frequency (harmonic) disturbance. Three bars of the bargraph directly beneath the annunciator illuminate if the disturbance is greater than 25 V.

TEMPERATURE MEASUREMENT (5370 only)

1. To measure temperature in degrees Celsius, set the **Function Switch** to the $^{\circ}\text{C}$ position. To measure temperature in degrees Fahrenheit, press the **SEL/ON** button.
2. Connect the temperature probe assembly to the $V\Omega$ jack and the **COM** jack.
3. Connect the **B+K Precision** Model TP-5300 temperature probe to the test point.
4. Read the temperature from the display. The $^{\circ}$ symbol illuminates and right most digit indicates C for Celsius measurement or F for Fahrenheit.

MAINTENANCE

The multimeter requires no maintenance other than replacing blown fuses or weak or dead batteries. The multimeter monitors the condition of the two fuses and the battery.

The display shows FUSE 1 if fuse F1 (0.63 A) is blown. The display shows FUSE 2 if fuse F2 (10 A) is blown. If both fuses are blown, the display shows FUSES.

NOTE

Fuse F1 is tested only when the **Function Switch** is in the $\mu\text{A}/\text{mA}$ position.

The display shows BAT when the battery is low. When the BAT annunciator first appears, the battery has approximately 10% (50 hours) of life remaining.

Use the following procedure to open the multimeter case and replace a blown fuse or the battery.

1. Pivot up the tilt stand and rotate it to remove it from the back of the multimeter.
2. Refer to Figure 13, and use one leg of the stand to pry the SECURX test lead retainer slightly away from the multimeter housing. Remove the SECURX.
3. Refer to Figure 14, and use the legs of the tilt stand to pry the cover of the multimeter loose. Pry one side off and then the other side. Remove the cover from the multimeter. Carefully remove the clear insulator.

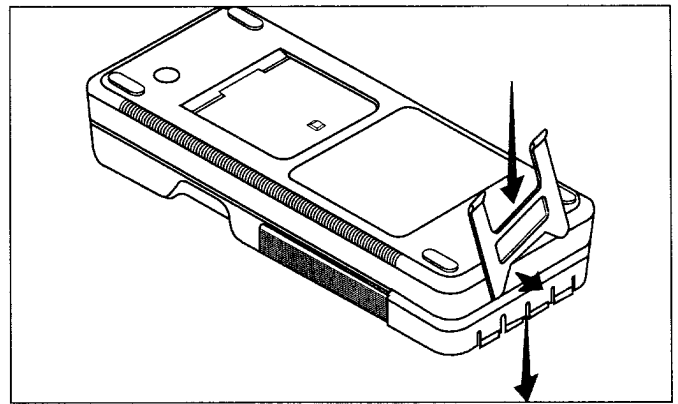

Fig. 13 Removing the SECURX

4. Refer to Figure 15 to locate the fuses and the battery. Replace the blown fuse or battery.
5. Carefully replace the insulator, and snap the top cover in place.
6. Slide the SECURX in place.
7. Snap the tilt stand into the back of the multimeter.

MAINTENANCE

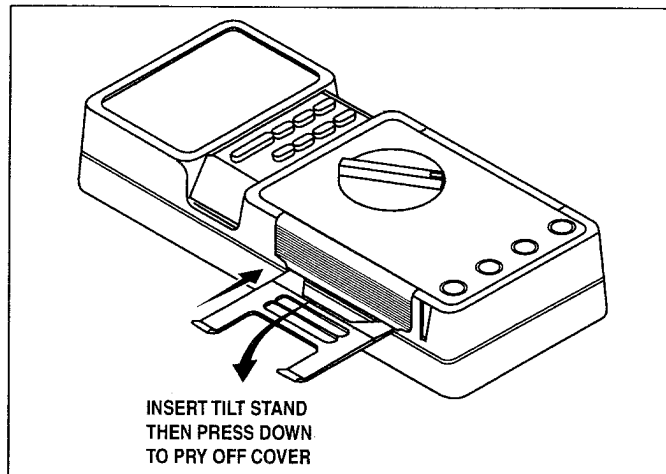

Fig. 14 Opening the Case

INSTRUMENT REPAIR SERVICE

Because of the specialized skills and test equipment required for instrument repair and calibration, many customers prefer to rely upon **B+K PRECISION** for this service. We maintain a network of **B+K PRECISION** authorized service agencies for this purpose. To use this service, even if the instrument is no longer under warranty, follow the instructions given in the WARRANTY SERVICE INSTRUCTIONS portion of this manual. There is a nominal charge for instruments out of warranty.

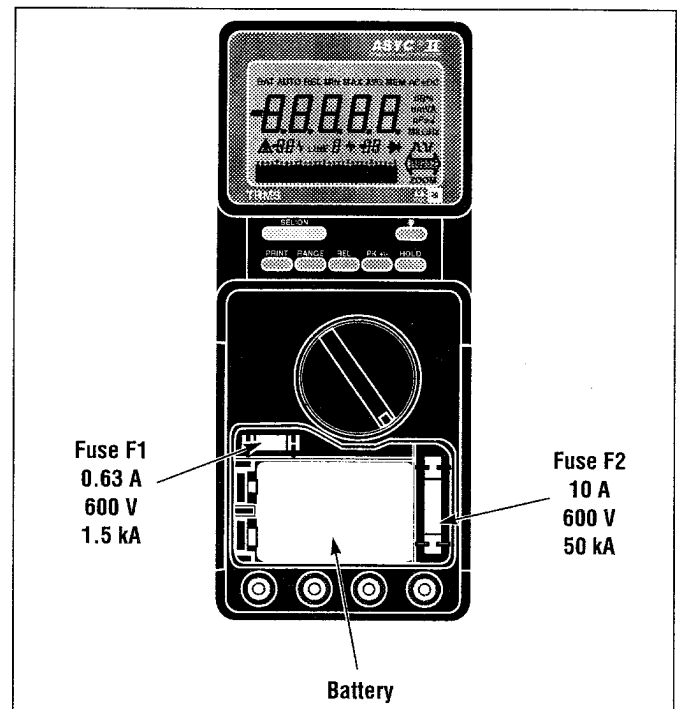

Fig. 15 Locating Battery and Fuses

SPECIFICATIONS

NOTES

1. Unless otherwise stated, accuracy specifications apply from 18°C to 28°C.
2. Accuracy Specifications stated as **n%R+nD**, means $\pm(n\%$ of reading +n least significant digits).
3. Accuracy Specifications stated as **n%FS**, means $\pm(n\%$ of Full Scale)

DC VOLTAGE (Auto/Manual Ranging)

DCV accuracy from 21°C to 25°C (5390 and 5380).

| Ranges | Accuracy | | | | Resolution | Input Impedance |
|--------|------------|------------|-----------|----------|-------------|---------------------------------|
| | 5390 | 5380 | 5370 | 5360 | | |
| 500 mV | 0.025%R+2D | 0.025%R+2D | 0.05%R+2D | 0.1%R+2D | 10 μ V | 10 M Ω or 1 G Ω * |
| 5 V | 0.025%R+2D | 0.025%R+2D | 0.05%R+2D | 0.1%R+2D | 100 μ V | 11 M Ω |
| 50 V | 0.025%R+2D | 0.025%R+2D | 0.05%R+2D | 0.1%R+2D | 1 mV | 10 M Ω |
| 500 V | 0.025%R+2D | 0.025%R+2D | 0.05%R+2D | 0.2%R+2D | 10 mV | 10 M Ω |
| 1000 V | 0.025%R+2D | 0.025%R+2D | 0.05%R+2D | 0.3%R+2D | 100 mV | 10 M Ω |

* (10 M Ω only on 5360)

Overload Protection: ± 1100 V DC+AC peak, beeper sounds if exceeded
 Transient Protection: 6 kV for 10 μ s
 Normal Mode Rejection: >60 dB, selectable 50 Hz and 60 Hz
 Common Mode Rejection: >120 dB, selectable 50 Hz and 60 Hz

AC VOLTAGE (Auto/Manual Ranging, True RMS)

Modes: AC or AC+DC, selectable

Models 5390, 5380 and 5370

Accuracy at greater than 10% of range, 50,000 counts at Full Scale:

| Ranges | DC to 1 kHz | 1 kHz to 4 kHz | 4 kHz to 10 kHz | 10 kHz to 30 kHz | 30 kHz to 50 kHz | Resolution | Input Impedance |
|--------|-------------|----------------|-----------------|------------------|------------------|-------------|---------------------------------------|
| 500 mV | 0.3%R+30D | 1%R+30D | 5%R+30D | Not specified | | 10 μ V | 10 M Ω /100 pF or 1 G Ω |
| 5 V | 0.3%R+30D | 1%R+30D | 2%R+30D | 2%R+30D | 3%R+30D | 100 μ V | 11 M Ω /100 pF |
| 50 V | 0.3%R+30D | 1%R+30D | 2%R+30D | 2%R+30D | 3%R+30D | 1 mV | 10 M Ω /100 pF |
| 500 V | 0.3%R+30D | 1%R+30D | 2%R+30D | 2%R+30D | 3%R+30D | 10 mV | 10 M Ω /100 pF |
| 750 V | 0.3%R+30D | Not specified | | | | 100 mV | 10 M Ω /100 pF |

50 kHz to 100 kHz (5 V, 50 V, 500 V ranges): $\pm 6\%$ FS typical

Crest Factor: 6

Accuracy Factor: 0.2% for crest factor of 2 to 3
 0.5% for crest factor of 3 to 6

Overvoltage Protection: ± 1100 V DC+AC peak, beeper sounds if exceeded

Transient Protection: 6 kV for 10 μ s

Common Mode Rejection: >80 dB, selectable 50 Hz or 60 Hz

SPECIFICATIONS

Model 5360

Accuracy at greater than 10% of range, 5,000 counts at Full Scale:

| Ranges | DC to 1 kHz | 1 kHz to 5 kHz | 5 kHz to 10 kHz | 10 kHz to 20 kHz | 20 kHz to 30 kHz | Resolution | Input Impedance |
|--------|-------------|----------------|-----------------|------------------|------------------|-------------|-----------------------|
| 500 mV | 1%R+3D | 4%R+3D | Not specified | | | 100 μ V | 10 M Ω /100 pF |
| 5 V | 1%R+3D | 1%R+3D | 2%R+3D | 2%R+3D | 3%R+3D | 1 mV | 11 M Ω /100 pF |
| 50 V | 1%R+3D | 1%R+3D | 2%R+3D | 2%R+3D | 3%R+3D | 10 mV | 10 M Ω /100 pF |
| 500 V | 1%R+3D | 1%R+3D | 2%R+3D | 2%R+3D | 3%R+3D | 100 mV | 10 M Ω /100 pF |
| 750 V | 1%R+3D | Not specified | | | | 1 V | 10 M Ω /100 pF |

Crest Factor: 3

Accuracy Factor: 1.0% for crest factor of 1.5 to 2
4.0% for crest factor of 2 to 3.

Overvoltage Protection: \pm 1100 V DC+AC peak, beeper sounds if exceeded

Transient Protection: 6 kV for 10 μ s

Common Mode Rejection: 80 dB, selectable 50 Hz or 60 Hz

DC CURRENT (Auto/Manual Ranging)

| Ranges | Accuracy | | Resolution | Max Burden Voltage |
|-------------|------------------|---------------|------------|--------------------|
| | 5390, 5380, 5370 | 5360 | | |
| 500 μ A | 0.2%R+5D | Not Available | 10 nA | 700 mV |
| 5 mA | 0.2%R+2D | 0.2%R+2D | 100 nA | 700 mV |
| 50 mA | 0.05%R+2D | 0.2%R+2D | 1 μ A | 700 mV |
| 500 mA | 0.2%R+2D | 0.2%R+2D | 10 μ A | 1.5 V |
| 10 A | 0.5%R+2D | 0.5%R+2D | 1 mA | 500 mV |

Overload Protection: 630 mA, 600 V fuse for mA ranges, interrupts 1500 A
10 A, 600 V fuse for 10 A range, interrupts 50,000 A
Display indicates blown fuse F1, F2 or FUSES

AC CURRENT (Auto/Manual Ranging, True RMS)

Models 5390, 5380, and 5370.

Accuracy at greater than 10% of range, 50,000 counts at Full Scale:

| Ranges | DC to 1 kHz | 1 kHz to 10 kHz | 10 kHz to 20 kHz | 20 kHz to 30 kHz | Resolution | Max Burden Voltage |
|-------------|-------------|-----------------|------------------|------------------|------------|--------------------|
| 500 μ A | 0.75%R+50D | 0.75%R+50D | 1.0%R+50D | 3.0%R+50D | 10 nA | 700 mV |
| 5 mA | 0.6%R+50D | 0.6%R+50D | 1.0%R+50D | 2.0%R+50D | 100 nA | 700 mV |
| 50 mA | 0.6%R+50D | 0.6%R+50D | 1.0%R+50D | 2.0%R+50D | 1 μ A | 700 mV |
| 500 mA | 0.7%R+50D | 0.7%R+50D | Not specified | | 10 μ A | 1.5 V |
| 10 A | 1% of FS | Not specified | | | 1 mA | 500 mV |

Crest Factor: 6

Accuracy Factor: 0.2% for crest factor of 2 to 3
0.5% for crest factor of 3 to 6

Overload Protection: 630 mA, 600 V fuse for mA ranges, interrupts 1500 A
10 A, 600 V fuse for 10 A range, interrupts 50,000 A
Display indicates blown fuse F1, F2, or FUSES

Model 5360. Accuracy at greater than 10% of range, 5,000 counts at Full Scale:

| Ranges | DC to 5 kHz | Resolution | Max Burden Voltage |
|--------|-------------|-------------|--------------------|
| 5 mA | 1.0%R+3D | 1 μ A | 700 mV |
| 50 mA | 1.0%R+3D | 10 μ A | 700 mV |
| 500 mA | 1.0%R+3D | 100 μ A | 1.5 V |
| 10 A | 1% of FS | 10 mA | 500 mV |

Crest Factor: 3

Accuracy Factor: 1.0% for crest factor of 1.5 to 2
4.0% for crest factor of 2 to 3

Overload Protection: 630 mA, 600 V fuse for mA ranges, interrupts 1500 A
10 A, 600 V fuse for 10 A range, interrupts 50,000 A
Display indicates blown fuse F1, F2, or FUSES

SPECIFICATIONS

RESISTANCE (AUTO/MANUAL RANGING)

| Ranges | Accuracy 5390, 5380, 5370 | Accuracy 5360 | Resolution | Test Current |
|---------|------------------------------|------------------|------------|--------------|
| 500 Ω | 0.07%R+5D | 0.1%R+5D | 10 mΩ | 1 mA |
| 5 k Ω | 0.07%R+2D | 0.1%R+2D | 100 mΩ | 100 μA |
| 50 k Ω | 0.07%R+2D | 0.1%R+2D | 1 Ω | 10 μA |
| 500 k Ω | 0.07%R+2D | 0.1%R+2D | 10 Ω | 1 μA |
| 5 MΩ | 0.3%R+2D | 0.3%R+2D | 100 Ω | 100 nA |
| 50 MΩ | 1.0%R+2D | 1.0%R+2D | 1 kΩ | 10 nA |

Max Open Circuit Voltage: 7V

Overload Protection: 600V DC+AC peak

CONTINUITY

Threshold: 10 Ω to 20 Ω

Response Time: 1 ms

Overload Protection: 600 V DC+AC peak

DIODE TEST

Measures forward voltage drop of diode 0 to 1.999V

Test current: 1 mA ±20%

Overload Protection: 600V DC+AC peak

CAPACITANCE (Auto/Manual Ranging)

Accuracy, 5,000 counts at Full Scale:

| Ranges | Accuracy | | Resolution | Measurement Current | Max Measurement Time |
|---------|------------------|----------|------------|------------------------|----------------------------|
| | 5390, 5380, 5370 | 5360 | | | |
| 50 nF | 1.0%R+2D | 1.0%R+2D | 10 pF | 100 nA | 0.5 sec. |
| 500 nF | 1.0%R+2D | 1.0%R+2D | 100 pF | 1 μA | 0.5 sec. |
| 5 μF | 1.0%R+2D | 1.0%R+2D | 1 nF | 10 μA | 0.5 sec. |
| 50 μF | 1.0%R+2D | 1.0%R+2D | 10 nF | 100 μA | 0.5 sec. |
| 500 μF | 1.0%R+2D | 1.0%R+2D | 100 nF | 1 mA | 1.5 sec. |
| 5000 μF | 1.0%R+2D | 2.0%R+2D | 1 μF | 1 mA | 3 sec./ mF |
| 50 mF | 1.0%R+2D | 2.0%R+2D | 10 μF | 1 mA | 3 sec./ mF |

Overload Protection: 600V DC+AC peak

FREQUENCY (Autoranging)

Frequency Range: 0.6 Hz to 500 kHz

Accuracy: ±(0.03% rdg + 1 dgt)

Sensitivity:

| Range | 500 mV (5390, 5370) | 5 V to 500 V 500 μA to 500 mA | 750 V | 10 A (5390, 5370) |
|-------------------|------------------------|----------------------------------|---------------|----------------------|
| 0.6 Hz to 5 kHz | 2% of FS | 2% of FS | 100 V | 2 A |
| 5 kHz to 50 kHz | 5% of FS | 5% of FS | 250 V | |
| 50 kHz to 500 kHz | Not Specified | 10% of FS | Not Specified | |

SPECIFICATIONS

PEAK HOLD

| | |
|-------------------|--|
| Selection: | Peak + or Peak – (surge or sag) |
| Acquisition Time: | <1 ms |
| Applicable Modes: | VDC, mVDC, mAADC, 10ADC |
| Accuracy: | For pulse >1ms, (1% reading + 50 digits) |

dB MEASUREMENT (5390 and 5370)

Measures value relative to a reference from 1 to 9999 Ω . Factory preset for reference is 600 Ω . Refer to dBm measurement procedure to set impedance.

| | |
|--------------------|--------------------------------|
| Accuracy in dB: | 0.09 x VAC accuracy in percent |
| Resolution: | ± 0.01 dB |
| Measurement range: | 10 mVAC to 750 VAC |

dB MEASUREMENT (5380)

Converts VAC to dBm across 600 ohms, 0 dBm = 0.7746 mVAC

| | |
|--------------------|--------------------------------|
| Accuracy in dB: | 0.09 x VAC accuracy in percent |
| Resolution: | ± 0.01 dB |
| Measurement range: | 10 mVAC to 750 VAC |

DUTY CYCLE (5390, 5370, 5360)

| | |
|-----------------------|------------------------|
| Modes: | Selectable %+, %– |
| Resolution: | 0.01% |
| Minimum pulse width: | 2 μ s |
| Maximum pulse period: | 0.8 s |
| Minimum pulse period: | 100 μ s |
| Accuracy: | Same as FREQUENCY mode |

EVENT COUNTER (5390)

| | |
|-------------------------|---|
| Range: | 0 to 99999 (totalize) |
| Minimum pulse duration: | 2 μ s |
| Reset: | Relative key |
| Sensitivity: | 3% of range (excludes 750 V, 10 A ranges) |

PULSE WIDTH (5390)

| | |
|-----------------------|---|
| Modes: | Selectable + or – |
| Resolution: | 10 μ s |
| Minimum pulse width: | 20 μ s |
| Maximum pulse period: | 12.5 s |
| Accuracy: | $\pm(0.01\% + 10 \mu$ s) |
| Sensitivity: | 3% of range (excludes 750 V, 10 A ranges) |

POWER DISTURBANCE INDICATOR (5390, 5370)

Display indicates Power Disturbance for transient voltage >80V, or high frequency (1 kHz to 100 kHz) Harmonic Disturbance >25 V

TEMPERATURE (5370)

Using Model TP-5300 Platinum Temperature Probe

| | |
|--------------------|---|
| Temperature Range: | –200°C to +800°C |
| Resolution: | 0.1°C |
| Accuracy: | –125 C to +75 C: 0.5°C –150 C to +700 C: 1.0 C |
| Display: | °C or °F, selectable |

COMPUTER INTERFACE

RS-232 capability built-in Requires AK-5300 or AK-5350 hardware/software kit for interconnection to computer or printer.

SPECIFICATIONS

GENERAL SPECIFICATIONS

| | | | |
|-------------------------|---|--------------------------|---|
| Display: | 50,000 count LCD, 14-mm digit height, 34-segment analog bargraph (with backlight for models 5390, 5380, and 5370). Annunciators for function and unit of measurement. | Auto Power Off Override: | Does not shut off with live circuit, RS-232 active or Peak Hold |
| Measurement Rate: | 2 per second, 20 per second for bargraph. | Dimensions (HxWxD): | 1-5/8" x 3-1/4" x 7-1/2" (40 mm x 82 mm x 189 mm) |
| Environmental: | | Weight: | 14 oz. |
| Operation: | 0° to 50°C 0 to 80% RH to 40°C 0 to 70% RH to 50°C | Safety: | IEC1010-1 class 2, 600V cat III, 1000V cat II Live circuit indication above 24 V 6 kV transient protection 600 V high energy fuses on all current ranges |
| Limited Operation: | -10°C to +60°C, <80% RH | Ruggedness: | Sealed, watertight case, IP677 |
| Storage: | -40°C to +70°C without battery | Shock & Vibration: | MIL-T-28800 |
| Power Requirement: | 9V battery | Case Material: | Flame retardant, self extinguishing |
| Battery Life: | 500 hours | EMC: | Emission EN55011, class B, susceptibility IEC801-4, level 3, radiation IEC 801-3 (10V/M) level 3 |
| Low Battery Indication: | BAT displayed | Calibration: | One year, recalibration by serial interface without opening case |
| Auto Power Off: | 30 minutes | | |

ACCESSORIES

ACCESSORIES SUPPLIED

Battery, Test Leads, Instruction Manual

OPTIONAL ACCESSORIES

The following accessories are available for each of the multimeters:

The models 5390, 5380, 5370, and 5360 have built-in RS-232 capability. However, special hardware is required to complete the interconnection to a computer. The models AK-5300 and AK-5350 include the special hardware required.

Model AK-5300 Calibration Hardware and Software Kit

This kit contains the hardware and software needed to recalibrate and to document the calibration of your multimeter.

Model AK-5350 Data Acquisition Hardware and Software Kit

This kit contains the hardware and software needed to download data from your multimeter to your PC, and to control the multimeter from the PC.

Model AK-5301 Calibration Software

This accessory adds calibration capability to the Model AK-5350 Data Acquisition Hardware and Software Kit.

Model AK-5351 Data Acquisition Software

This accessory adds data acquisition capability to the Model AK-5300 Calibration Hardware and Software Kit.

LC-5300 Carrying Case

Provides a convenient and safe means for storing and transporting the multimeters.

TP-5300 Temperature Probe

Platinum temperature probe designed for use with Model 5370 Multimeter.

Replacement Test Leads

Replacement test leads must have a shoulder for the SECURX test lead retainer to work properly. **B+K Precision** Models TL-100, TL-110 and TL-120 test leads have the necessary shoulders to actuate this important safety feature.

Test Lead Tips

B+K Precision offers a wide variety of test lead tips to make appropriate connections in most applications. Such tips include alligator clips, spring hooks, spade lugs, surface mount device tips, etc.