

FLUKE®

87V Ex
True-rms Multimeter

Users Manual

PN 2518115

December 2005

©2005 Fluke Corporation. All rights reserved. Printed in USA

All product names are trademarks of their respective companies.

LIMITED WARRANTY AND LIMITATION OF LIABILITY

Each Fluke product is warranted to be free from defects in material and workmanship under normal use and service. The warranty period is one year and begins on the date of shipment. Parts, product repairs, and services are warranted for 90 days. This warranty extends only to the original buyer or end-user customer of a Fluke authorized reseller, and does not apply to fuses, disposable batteries, or to any product which, in Fluke's opinion, has been misused, altered, neglected, contaminated, or damaged by accident or abnormal conditions of operation or handling. Fluke warrants that software will operate substantially in accordance with its functional specifications for 90 days and that it has been properly recorded on non-defective media. Fluke does not warrant that software will be error free or operate without interruption.

Fluke authorized resellers shall extend this warranty on new and unused products to end-user customers only but have no authority to extend a greater or different warranty on behalf of Fluke. Warranty support is available only if product is purchased through a Fluke authorized sales outlet or Buyer has paid the applicable international price. Fluke reserves the right to invoice Buyer for importation costs of repair/replacement parts when product purchased in one country is submitted for repair in another country.

Fluke's warranty obligation is limited, at Fluke's option, to refund of the purchase price, free of charge repair, or replacement of a defective product which is returned to a Fluke authorized service center within the warranty period.

To obtain warranty service, contact your nearest Fluke authorized service center to obtain return authorization information, then send the product to that service center, with a description of the difficulty, postage and insurance prepaid (FOB Destination). Fluke assumes no risk for damage in transit. Following warranty repair, the product will be returned to Buyer, transportation prepaid (FOB Destination). If Fluke determines that failure was caused by neglect, misuse, contamination, alteration, accident, or abnormal condition of operation or handling, including overvoltage failures caused by use outside the product's specified rating, or normal wear and tear of mechanical components, Fluke will provide an estimate of repair costs and obtain authorization before commencing the work. Following repair, the product will be returned to the Buyer transportation prepaid and the Buyer will be billed for the repair and return transportation charges (FOB Shipping Point).

THIS WARRANTY IS BUYER'S SOLE AND EXCLUSIVE REMEDY AND IS IN LIEU OF ALL OTHER WARRANTIES, EXPRESS OR IMPLIED, INCLUDING BUT NOT LIMITED TO ANY IMPLIED WARRANTY OF MERCHANTABILITY OR FITNESS FOR A PARTICULAR PURPOSE. FLUKE SHALL NOT BE LIABLE FOR ANY SPECIAL, INDIRECT, INCIDENTAL, OR CONSEQUENTIAL DAMAGES OR LOSSES, INCLUDING LOSS OF DATA, ARISING FROM ANY CAUSE OR THEORY.

Since some countries or states do not allow limitation of the term of an implied warranty, or exclusion or limitation of incidental or consequential damages, the limitations and exclusions of this warranty may not apply to every buyer. If any provision of this Warranty is held invalid or unenforceable by a court or other decision-maker of competent jurisdiction, such holding will not affect the validity or enforceability of any other provision.

Fluke Corporation
P.O. Box 9090
Everett, WA 98206-9090
U.S.A.

Fluke Europe B.V.
P.O. Box 1186
5602 BD Eindhoven
The Netherlands

11/99

Table of Contents

Title	Page
Introduction.....	1
Contacting Fluke	1
General Safety Information.....	2
ATEX Safety Information.....	2
Errors and Load Restrictions	5
Ex-Certification Data.....	6
The Meter's Features	8
Power-Up Options	15
Automatic Power-Off	15
Input Alert™ Feature	15
Making Measurements	15
Measuring AC and DC Voltage.....	15
Zero Input Behavior of True-rms Meters.....	17
Low Pass Filter	17
Measuring Temperature	18
Testing for Continuity.....	18
Measuring Resistance	20
Using Conductance for High Resistance or Leakage Tests.....	22
Measuring Capacitance	23
Testing Diodes.....	24
Measuring AC or DC Current.....	26
Measuring Frequency	29

Measuring Duty Cycle	31
Determining Pulse Width	32
Bar Graph	32
Zoom Mode (Power Up Option Only)	33
Uses for the Zoom Mode	33
HiRes Mode	33
MIN MAX Recording Mode	34
Smooth Feature (Power Up Option Only)	34
AutoHOLD Mode	36
Relative Mode	36
Maintenance	37
General Maintenance	37
Fuse Test	37
Replacing the Battery	38
Replacing the Fuses	39
Service and Parts	40
General Specifications	45
Detailed Specifications	46
AC Voltage Function	46
DC Voltage, Resistance, and Conductance Function	47
Temperature	48
Current Function	49
Capacitance and Diode Function	50
Frequency Counter	50
Frequency Counter Sensitivity and Trigger Levels	51
Electrical Characteristics of the Terminals	52
MIN MAX Recording	53

List of Tables

Table	Title	Page
1.	Electrical Symbols	7
2.	Inputs.....	8
3.	Rotary Switch Positions	9
4.	Pushbuttons	10
5.	Display Features.....	13
6.	Functions and Trigger Levels for Frequency Measurements.....	30
7.	MIN MAX Functions.....	35
8.	Approved Batteries	39
9.	Replacement Parts	42
10.	Specified Accessories	44

87V Ex
Users Manual

List of Figures

Figure	Title	Page
1.	Display Features.....	13
2.	Measuring AC and DC Voltage.....	16
3.	Low Pass Filter.....	17
4.	Testing for Continuity.....	19
5.	Measuring Resistance	21
6.	Measuring Capacitance	23
7.	Testing a Diode	25
8.	Measuring Current.....	27
9.	Components of Duty Cycle Measurements	31
10.	Testing the Current Fuses	38
11.	Battery and Fuse Replacement	41
12.	Replaceable Parts	43

87V Ex
Users Manual

True-rms Multimeter

Introduction

⚠ ⚠ Warning

Read "Safety Information" before you use the Meter.

The Fluke 87V Ex Intrinsically Safe True-rms Multimeter (hereafter referred to as "the Meter") is a compact and easy to operate measurement tool for electrical and electronic circuits.

The Meter is designed for use in potentially explosive areas of Zone 1 or 2 as specified in Directive 1999/92/EC (ATEX 137). Failure to follow these instructions may have dangerous consequences.

Read the entire Users Manual before using the Meter.

Contacting Fluke

To contact Fluke, call one of the following telephone numbers:

USA: 1-888-44-FLUKE (1-888-443-5853)

Canada: 1-800-36-FLUKE (1-800-363-5853)

Europe: +31 402-675-200

Japan: +81-3-3434-0181

Singapore: +65-738-5655

Anywhere in the world: +1-425-446-5500

For USA Service: 1-888-99-FLUKE

(1-888-993-5853)

Or, visit Fluke's Web site at www.fluke.com.

To register your product, visit register.fluke.com

General Safety Information

The Meter complies with:

- EN61010-1:2001
- ANSI/ISA S82.01-2004
- CAN/CSA C22.2 No. 1010.1:2004
- Measurement Category III, 1000V, Pollution Degree 2
- Measurement Category IV, 600V, Pollution Degree 2
- Industrial use in potentially explosive areas of zone 1 or 2, according to ATEX requirements (ATEX 137)(see the ATEX safety instructions & regulations section)

In this manual, a **Warning** identifies conditions and actions that pose hazards to the user. A **Caution** identifies conditions and actions that may damage the Meter or the equipment under test.

Electrical symbols used on the Meter and in this manual are explained in Table 1.

To ensure safe operation of the Meter, fully observe all instructions and warnings contained in this manual.

ATEX Safety Information

This manual contains information and safety regulations that must be followed to ensure safe, reliable operation of

the Meter in hazardous areas under the described conditions. Failure to follow the information and instructions can have dangerous consequences, or may contravene applicable legislation.

Please take the time to read through this manual before you start using the Meter.

To ensure safe operation of this Meter, fully observe all instructions and warnings contained in the manual. In case of doubt (due to translation and/or printing errors), refer to the original English manual.

Warning

To avoid possible electric shock or personal injury while working in EX-HAZARDOUS areas, follow these guidelines:

- **Do not open the Meter while in an Ex-hazardous area.**
- **Change the Meter's battery only outside Ex-hazardous areas.**
- **Do not carry additional or spare batteries in Ex-hazardous areas.**
- **Use only type-approved batteries in the Meter. Refer to the "Replacing the Battery" section for a list of approved batteries.**
- **Do not replace fuses while in an Ex-hazardous area.**

- Use only fuses approved for Ex-hazardous areas in this Meter. See the “Replacing the Fuses” section for a list of approved fuses.
- After using the Meter on a non-i.s. protected circuit, observe a 3-minute rest period before taking the Meter into an Ex-hazardous area.
- The Meter must be completely and securely fitted in the red holster while it is in an Ex-hazardous area.
- Do not open function buttons inside the Meter. Interference or damage to any of these elements removes the Ex-protection.
- Observe the tolerances or threshold values found in the “Specifications” section of this manual.
- Use only allowed accessories with this Meter in Ex-hazardous areas. See a listing of allowed Fluke accessories at www.Fluke.com.
- Avoid using the Meter in aggressive acidic or alkaline solutions.
- Do not use the Meter in zone 0.

- Never measure voltages greater than 65 volts in an Ex-hazardous area.
- Never measure currents greater than 5 amps while using the Meter in an Ex-hazardous area.
- Servicing not covered in this manual should be performed only by the manufacturer. Repair or service by others may void the ATEX certification of this Meter.

⚠⚠ Warning

To avoid possible electric shock or personal injury in ALL areas of operation, follow these guidelines:

- Use this Meter only as specified in this manual or the protection provided by the Meter might be impaired.
- See the “ATEX Safety Information” section for additional warnings on meter use in hazardous areas.
- Do not use the Meter if it is damaged. Before you use the Meter, inspect the case. Look for cracks or missing plastic. Pay particular attention to the insulation surrounding the connectors.

- Ensure the battery door is closed and latched whenever operating the Meter.
- Replace the battery as soon as the battery indicator (🔋) appears. See “Replacing the Battery” section for instructions and a list of approved batteries.
- Remove test leads from the Meter before opening the battery door.
- Inspect the test leads for damaged insulation or exposed metal. Check the test leads for continuity. Replace damaged leads before using the Meter.
- Do not apply more than the rated voltage, as marked on the Meter, between the terminals or between any terminal and earth ground.
- Use caution when working with voltages above 30 V ac rms, 42 V ac peak, or 60 V dc. These voltages pose a shock hazard.
- Use only the replacement fuses specified in this Users Manual. See “Replacing the Fuses” section for instructions and a list of approved fuses.
- Use the proper terminals, function, and range for measurements.
- Avoid working alone.
- When measuring current, turn off circuit power before connecting the Meter to the circuit. Remember to place the Meter in series with the circuit.
- When making electrical connections, connect the common test lead before connecting the live test lead; when disconnecting, disconnect the live test lead before disconnecting the common test lead.
- Do not use the Meter if it operates abnormally. Protection may be impaired. When in doubt, have the Meter serviced.
- Use only a single 9 volt battery, properly installed in the Meter case, to power the Meter. See “Replacing the Battery” section for instructions and a list of approved batteries.
- Only use replacement parts listed in the “Parts” section of this manual. Return the Meter to the manufacturer for all other service needs.
- When using probes, keep your fingers behind the probe’s finger guards.

- **Do not use the Low Pass Filter option to verify the presence of hazardous voltages. Voltages greater than what is indicated may be present. First, make a voltage measurement without the filter to detect the possible presence of hazardous voltage. Then select the filter function.**
- **Do not use in wet environments.**

⚠ Caution

To avoid possible damage to the Meter or to the equipment under test, follow these guidelines:

- **Disconnect circuit power and discharge all high-voltage capacitors before testing resistance, continuity, diodes, or capacitance.**
- **Use the proper terminals, function, and range for all measurements.**
- **Before measuring current, check the Meter's fuses. (See "Fuse Test".)**
- **Observe all safety regulations and read the certificate.**

Errors and Load Restrictions

If there is any question that the safety or integrity of this Meter is compromised, remove it from operation and the Ex-hazardous area immediately. Also, take whatever actions are necessary to prevent the Meter from being accidentally placed into operation before it can be examined and approved for operation. It is recommended the Meter be returned to the manufacturer for examination.

The safety and reliability of the Meter may be at risk and discontinue use of the Meter if:

- Visible damage is evident on the Meter's housing.
- The Meter has been subjected to excessive loads for which it is not designed.
- The Meter has been improperly stored.
- The Meter has sustained damage in transit.
- Illegible inscriptions or lettering appears on the Meter.
- A Meter malfunction occurs.
- Obvious measuring inaccuracies occur.
- Measurements/simulations are no longer possible with the Meter.
- Permitted tolerances or threshold values have been exceeded.

87V Ex

Users Manual

Ex-Certification Data

- EC-type certificate no.: ZELM 05 ATEX 0274
- Ex-designation: Ex II 2 G EEx ia IIC T4
Measuring range: 65 V Max in Ex-hazardous areas.
5 A Max. in Ex-hazardous areas
- Power supply: 9 Volt block type, IEC 6LR61 (See Table 8 for approved batteries.)

- Measuring protected electric circuits:

Voltage-Mass (V/ Ω - COM):















$U_i = 65 \text{ V}$	$U_o = 10.35 \text{ V}$	$C_o = 2.52 \mu\text{F}$
	$I_o = 4.0 \text{ mA}$	$L_o = 100 \text{ mH}$

Current-Mass ($\mu\text{A}/\text{mA}$ & A - COM):

$I_i = 5 \text{ A}$	$U_o = 2.8 \text{ V}$	$C_o = 1000 \mu\text{F}$
	$I_o = 68 \text{ mA}$	$L_o = 8 \text{ mH}$

- Approved for Zones 2 and 1, device group II, gas group C potentially explosive gases, vapours and mist, temperature class T4.

Table 1. Electrical Symbols

	AC (Alternating Current)		Earth ground
	DC (Direct Current)		Fuse
	Capacitance		Diode
	Battery. Low battery when displayed.		Continuity test or continuity beeper tone.
	Hazardous voltage		Double insulated
	Risk of Danger. Important information. See Users Manual.		Do not mix with solid waste stream. Dispose using a qualified recycler or hazardous material handler.
CAT III	IEC Measurement Category III CAT III equipment is designed to protect against transients in equipment in fixed-equipment installations, such as distribution panels, feeders and short branch circuits, and lighting systems in large buildings.	CAT IV	IEC Measurement Category IV CAT IV equipment is designed to protect against transients from the primary supply level, such as an electricity meter or an overhead or underground utility service.
CE	Conforms to European Union directives.		Conforms to relevant Canadian and U.S. Standards.
	Inspected and licensed by TÜV Product Services.		Conforms to ATEX directive.

The Meter's Features

Tables 2 through 5 and Figure 1 briefly describe the Meter's features.

Table 2. Inputs

Terminal	Description
A	Input for 0 A to 10.00 A current (20 A overload for 30 seconds maximum), current frequency, and duty cycle measurements.
mA μ A	Input for 0 μ A to 400 mA current measurements (600 mA for 18 hrs.) and current frequency and duty cycle.
COM	Return terminal for all measurements.
 V Ω \rightarrow \vdash	Input for voltage, continuity, resistance, diode, capacitance, frequency, temperature, and duty cycle measurements.

Table 3. Rotary Switch Positions

















Switch Position	Function
Any Position	When the Meter is turned on, the Meter model number briefly appears on the display.
	AC voltage measurement Press  for low pass filter ( .
	DC voltage measurement
	600 mV dc voltage range Press  for temperature ( .
 Ω 	Press  for continuity test. Ω Resistance measurement Press  for capacitance measurement.
	Diode test
 	AC current measurements from 0 mA to 10.00 A Press  for dc current measurements, from 0 mA to 10.00 A.
	AC current measurements from 0 μ A to 6000 μ A Press  for dc current measurements from 0 μ A to 6000 μ A.

Table 4. Pushbuttons











Button	Switch Positon	Function
 (Yellow)	     Power-up	Selects capacitance Selects temperature Selects ac low pass filter function Switches between dc and ac current Switches between dc and ac current Disables automatic power-off feature (Meter normally powers off in 30 minutes). The Meter reads "PoFF" until  is released.
	Any switch position Power-up	Starts recording of minimum and maximum values. Steps the display through MAX, MIN, AVG (average), and present readings. Cancels MIN MAX (hold for 1 second) Enables the Meter's calibration mode and prompts for a password. The Meter reads "CAL" and enters calibration mode. See <i>87V Ex Service Information</i> .
	Any switch position  Power-up	Switches between the ranges available for the selected function. To return to autoranging, hold the button down for 1 second. Switches between °C and °F. Enables the Meter's smoothing feature. The Meter reads "S---" until  is released.

Table 4. Pushbuttons (cont.)













Button	Switch Position	Function
	Any switch position MIN MAX recording Frequency counter Power-up	AutoHOLD (formerly TouchHold) captures the present reading on the display. When a new, stable reading is detected, the Meter beeps and displays the new reading. Stops and starts recording without erasing recorded values. Stops and starts the frequency counter. Turns on all LCD segments.
	Any switch position	Turns the backlight on, makes it brighter, and turns it off. Hold  down for one second to enter the HiRes digit mode. The “HiRes” icon appears on the display. To return to the 3-1/2 digit mode, hold  down for one second. HiRes=19,999
	Continuity  MIN MAX recording Hz, Duty Cycle Power-up	Turns the continuity beeper on and off Switches between Peak (250 μs) and Normal (100 ms) response times. Toggles the meter to trigger on positive or negative slope. Disables the beeper for all functions. The Meter reads “bEEP” until  is released.

Table 4. Pushbuttons (cont.)

Button	Switch Position	Function
 (Relative mode)	Any switch position Power-up	Stores the present reading as a reference for subsequent readings. The display is zeroed, and the stored reading is subtracted from all subsequent readings. Enables zoom mode for the bar graph. The Meter reads “REL” until  is released.
	Any switch position except diode test Power-up	Press  for frequency measurements. Starts the frequency counter. Press again to enter duty cycle mode. Enables the Meter’s high impedance mode when the mV dc function is used. The Meter reads “Hz” until  is released.

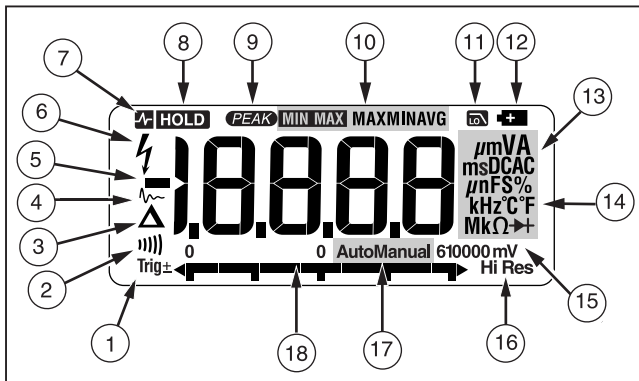

aom1_af.eps

Figure 1. Display Features

Table 5. Display Features

Number	Feature	Indication
①	±	Polarity indicator for the analog bar graph.
	Trig ±	Positive or negative slope indicator for Hz/duty cycle triggering.
②		The continuity beeper is on.
③	△	Relative (REL) mode is active.
④	~	Smoothing is active.

Number	Feature	Indication
⑤	-	Indicates negative readings. In relative mode, this sign indicates that the present input is less than the stored reference.
⑥	⚡	Indicates the presence of a high voltage input. Appears if the input voltage is 30 V or greater (ac or dc). Also appears in low pass filter mode. Also appears in cal, Hz, and duty cycle modes.
⑦	⏸ HOLD	AutoHOLD is active.
⑧	HOLD	Display Hold is active.
⑨	PEAK	Indicates the Meter is in Peak Min Max mode and the response time is 250 μs.
⑩	MIN MAX MAX MIN AVG	Indicators for minimum-maximum recording mode.
⑪	Lo	Low pass filter mode. See "Low Pass Filter."
⑫	+	The battery is low. Warning: To avoid false readings, which could lead to possible electric shock or personal injury, replace the battery as soon as the battery indicator appears.

Table 5. Display Features (cont.)

Number	Feature	Indication
⑬	A, μA, mA	Amperes (amps), Microamp, Milliamp
	V, mV	Volts, Millivolts
	μF, nF	Microfarad, Nanofarad
	nS	Nanosiemens
	%	Percent. Used for duty cycle measurements.
	Ω, MΩ, kΩ	Ohm, Megohm, Kilohm
	Hz, kHz	Hertz, Kilohertz
	AC DC	Alternating current, direct current
⑭	$^{\circ}$C, $^{\circ}$F	Degrees Celsius, Degrees Fahrenheit
⑮	610000 mV	Displays selected range
⑯	HiRes	The Meter is in high resolution (Hi Res) mode. HiRes=19,999
⑰	Auto	The Meter is in autorange mode and automatically selects the range with the best resolution.
	Manual	The Meter is in manual range mode.

Number	Feature	Indication
⑱		The number of segments is relative to the full-scale value of the selected range. In normal operation 0 (zero) is on the left. The polarity indicator at the left of the graph indicates the polarity of the input. The graph does not operate with the capacitance, frequency counter functions, temperature, or peak min max. For more information, see "Bar Graph". The bar graph also has a zoom function, as described under "Zoom Mode".
--	OL	Overload condition is detected.
Error Messages		
bAtt	Replace the battery immediately.	
diSC	In the capacitance function, too much electrical charge is present on the capacitor being tested.	
EEPr Err	Invalid EEPROM data. Have Meter serviced.	
CAL Err	Invalid calibration data. Calibrate Meter.	
LEAd	Δ Test lead alert. Displayed when the test leads are in the A or mA/μA terminal and the selected rotary switch position does not correspond to the terminal being used.	

Power-Up Options

Holding a button down while turning the Meter on activates a power-up option. Table 4 includes the power-up options.

Automatic Power-Off

The Meter automatically turns off if you do not turn the rotary switch or press a button for 30 minutes. If MIN MAX Recording is enabled, the Meter will not power off. To disable automatic power-off, refer to Table 4.

Input Alert™ Feature

If a test lead is plugged into the **mA/μA** or **A** terminal, but the rotary switch is not set to the correct current position, the beeper warns you by making a chirping sound and the display flashes "L E R D". This warning is intended to stop you from attempting to measure voltage, continuity, resistance, capacitance, or diode values when the leads are plugged into a current terminal.

⚠ Caution

Placing the probes across (in parallel with) a powered circuit when a lead is plugged into a current terminal can damage the circuit you are testing and blow the Meter's fuse. This can happen because the resistance through the Meter's current terminals is very low, so the Meter acts like a short circuit.

Making Measurements

The following sections describe how to take measurements with the Meter.

Measuring AC and DC Voltage

⚠⚠ Warning

To avoid possible electric shock or personal injury, never measure voltages greater than 65 volts in an Ex-hazardous area.

The Meter features true rms readings, which are accurate for distorted sine waves and other waveforms (with no dc offset) such as square waves, triangle waves, and staircase waves.

The Meter's voltage ranges are 600.0 mV, 6.000 V, 60.00 V, 600.0 V, and 1000 V. To select the 600.0 mV dc range, turn the rotary switch to mV.

To measure ac or dc voltage, refer to Figure 2.

When measuring voltage, the Meter acts approximately like a 10 M Ω (10,000,000 Ω) impedance in parallel with the circuit. This loading effect can cause measurement errors in high-impedance circuits. In most cases, the error is negligible (0.1% or less) if the circuit impedance is 10 k Ω (10,000 Ω) or less.

For better accuracy when measuring the dc offset of an ac voltage, measure the ac voltage first. Note the ac voltage range, then manually select a dc voltage range equal to or higher than the ac range. This procedure improves the accuracy of the dc measurement by ensuring that the input protection circuits are not activated.

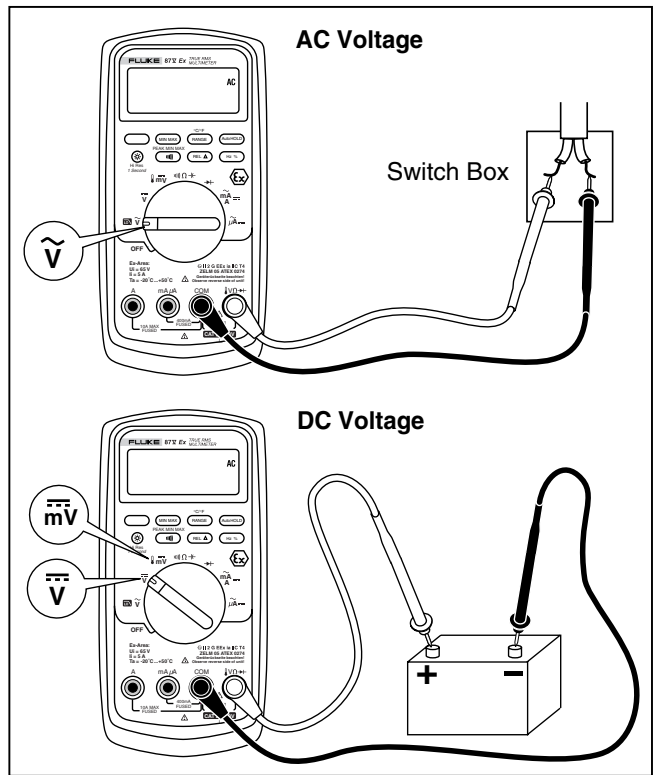

Figure 2. Measuring AC and DC Voltage

ecg2f.eps



Zero Input Behavior of True-rms Meters

True-rms meters accurately measure distorted waveforms, but when the input leads are shorted together in the AC functions, the meter displays a residual reading between 1 and 30 counts. When the test leads are open, the display readings may fluctuate due to interference. These offset readings are normal. They do not affect the Meter's AC measurement accuracy over the specified measurement ranges.

Unspecified input levels are:

- AC voltage: below 3 % of 600 mV AC, or 18 mV AC
- AC current: below 3 % of 60 mA AC, or 1.8 mA AC
- AC current: below 3 % of 600 μ A AC, or 18 μ A AC

Low Pass Filter

The Meter is equipped with an ac low pass filter. When measuring ac voltage or ac frequency, press  to activate the low pass filter mode (). The Meter continues measuring in the chosen ac mode, but now the signal diverts through a filter that blocks unwanted voltages above 1 kHz, refer to Figure 3. The lower frequency voltages pass with reduced accuracy to the measurement below 1 kHz. The low pass filter can improve measurement performance on composite sine waves that are typically generated by inverters and variable frequency motor drives.

Warning

To avoid possible electric shock or personal injury, do not use the Low Pass Filter option to verify the presence of hazardous voltages. Voltages greater than what is indicated may be present. First, make a voltage measurement without the filter to detect the possible presence of hazardous voltage. Then, select the filter function.

Note

In Low Pass Mode, the Meter goes to manual mode. Select ranges by pressing the RANGE button. Autoranging is not available in Low Pass Mode.

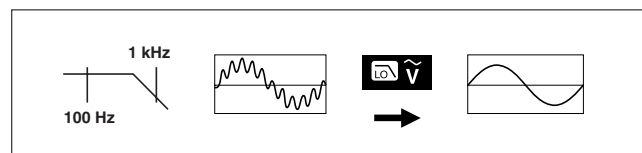

aom11f.eps

Figure 3. Low Pass Filter

Measuring Temperature



The Meter measures the temperature of a type-K thermocouple (included). Choose between degrees Celsius (°C) or degrees Fahrenheit (°F) by pushing .

Caution

To avoid possible damage to the Meter or other equipment, remember that while the Meter is rated for –200.0 °C to +1090.0 °C and –328.0 °F to 1994.0 °F, the included K-Type Thermocouple is rated to 260 °C.

Display ranges are –200.0 °C to +1090.0 °C and –328.0 °F to 1994.0 °F. Readings outside of these ranges show **OL** on the Meter display. When there is no thermocouple connected, the display also reads OL.

To measure temperature, do the following:

1. Connect a type-K thermocouple to the Meter's **COM** and $\mu\text{V } \Omega \rightarrow$ terminals.
2. Turn the rotary switch to μmV .
3. Press  to enter temperature mode.
4. Push  to choose Celsius or Fahrenheit.

Testing for Continuity

Caution

To avoid possible damage to the Meter or to the equipment under test, disconnect circuit power and discharge all high-voltage capacitors before testing for continuity.

The continuity test features a beeper that sounds as long as a circuit is complete. The beeper allows you to perform quick continuity tests without having to watch the display.

To test for continuity, set up the Meter as shown in Figure 4.

Press  to turn the continuity beeper on or off.

The continuity function detects intermittent opens and shorts lasting as little as 1ms. A brief short causes the Meter to emit a short beep.

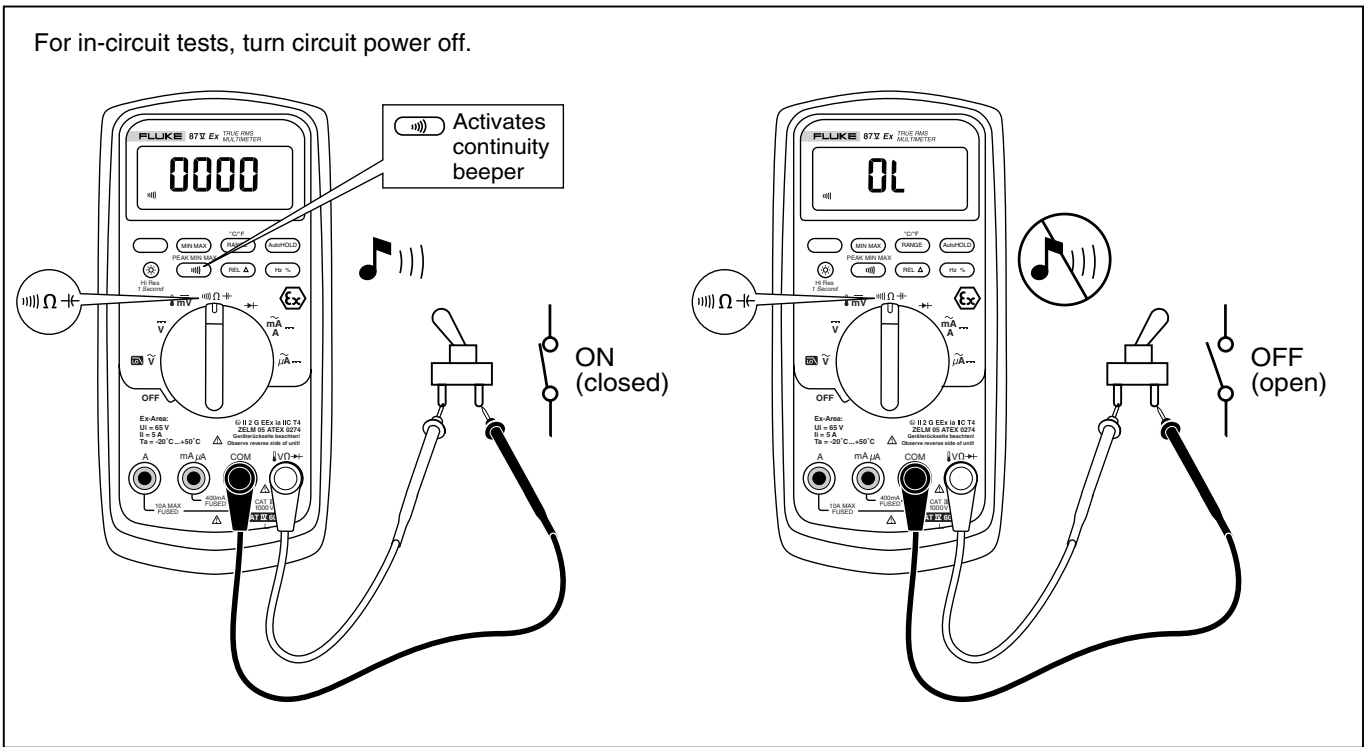

Figure 4. Testing for Continuity

ecg4f.eps

Measuring Resistance

Caution

To avoid possible damage to the Meter or to the equipment under test, disconnect circuit power and discharge all high-voltage capacitors before measuring resistance.

The Meter measures resistance by sending a small current through the circuit. Because this current flows through all possible paths between the probes, the resistance reading represents the total resistance of all paths between the probes.

The Meter's resistance ranges are 600.0 Ω , 6.000 k Ω , 60.00 k Ω , 600.0 k Ω , 6.000 M Ω , and 50.00M Ω .

To measure resistance, set up the Meter as shown in Figure 5.

The following are some tips for measuring resistance:

- The measured value of a resistor in a circuit is often different from the resistor's rated value.
- The test leads can add 0.1 Ω to 0.2 Ω of error to resistance measurements. To test the leads, touch the probe tips together and read the resistance of the leads. If necessary, you can use the relative (REL) mode to automatically subtract this value.
- The resistance function can produce enough voltage to forward-bias silicon diode or transistor junctions, causing them to conduct. If this is suspected, press  to apply a lower current in the next higher range. If the value is higher, use the higher value.

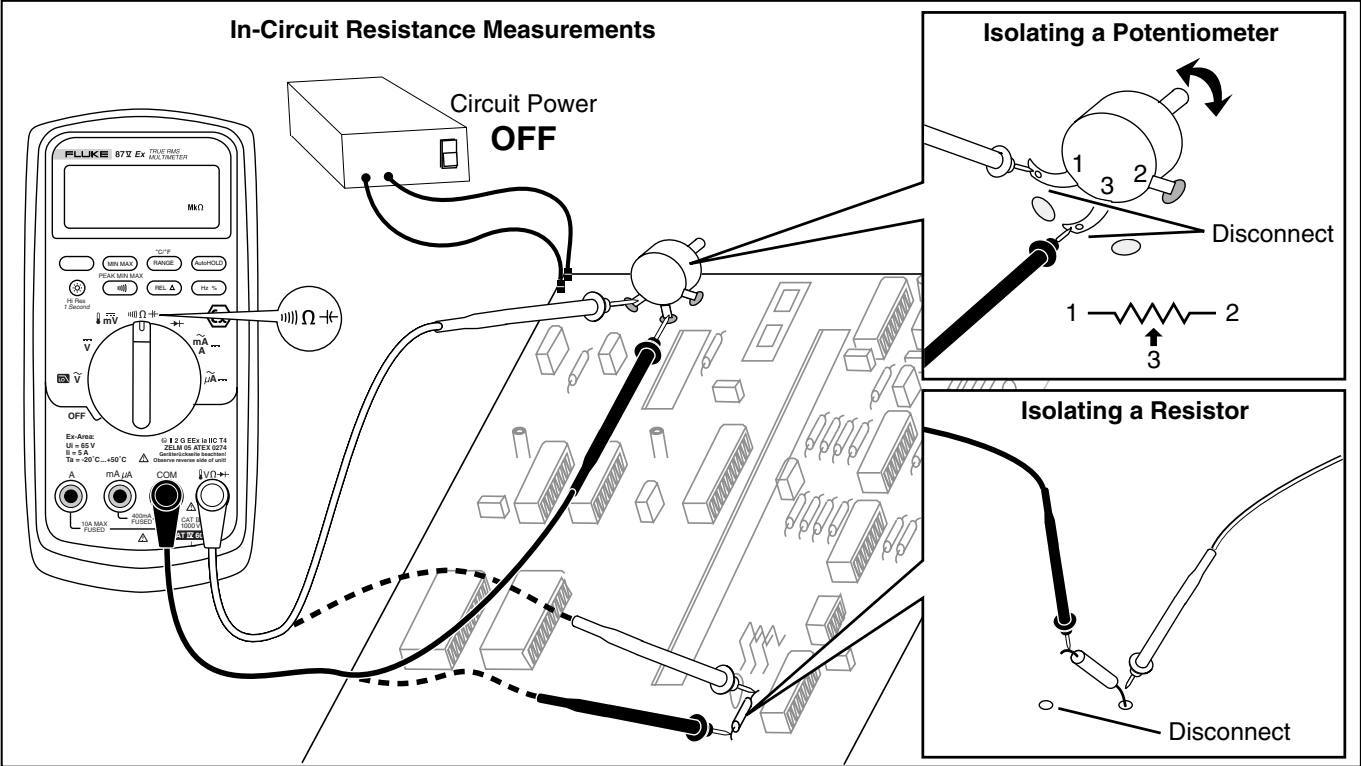



Figure 5. Measuring Resistance

ecg6f.eps

Using Conductance for High Resistance or Leakage Tests

Conductance, the inverse of resistance, is the ability of a circuit to pass current. High values of conductance correspond to low values of resistance.

The Meter's 60 nS range measures conductance in nanosiemens (1 nS = 0.000000001 Siemens). Because such small amounts of conductance correspond to extremely high resistance, the nS range lets you determine the resistance of components up to 100,000 M Ω , 1/1 nS = 1,000 M Ω .

To measure conductance, set up the Meter as shown for measuring resistance (Figure 5); then press  until the nS indicator appears on the display.

The following are some tips for measuring conductance:

- High-resistance readings are susceptible to electrical noise. To smooth out most noisy readings, enter the MIN MAX recording mode; then step to the average (AVG) reading.
- There is normally a residual conductance reading with the test leads open. To ensure accurate readings, use the relative (REL) mode to subtract the residual value.

Measuring Capacitance

⚠ Caution

To avoid possible damage to the Meter or to the equipment under test, disconnect circuit power and discharge all high-voltage capacitors before measuring capacitance. Use the dc voltage function to confirm that the capacitor is discharged.

The Meter's capacitance ranges are 10.00 nF, 100.0 nF, 1.000 μ F, 10.00 μ F, 100.0 μ F, and 9999 μ F.

To measure capacitance, set up the Meter as shown in Figure 6.

To improve the accuracy of measurements less than 1000 nF, use the relative (REL) mode to subtract the residual capacitance of the Meter and leads.

Note

If too much electrical charge is present on the capacitor being tested, the display shows "diSC".

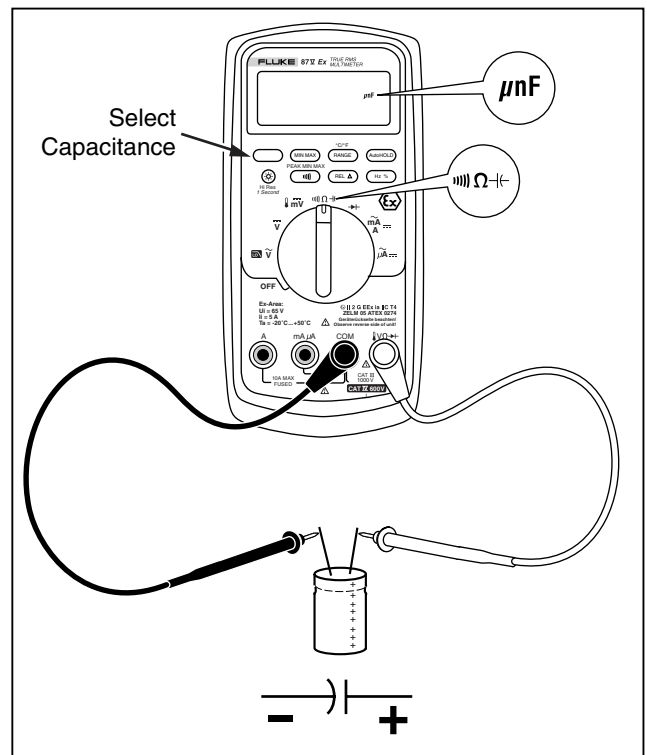

Figure 6. Measuring Capacitance

ecg10f.eps

Testing Diodes

⚠ Caution

To avoid possible damage to the Meter or to the equipment under test, disconnect circuit power and discharge all high-voltage capacitors before testing diodes.

Use the diode test to check diodes, transistors, silicon controlled rectifiers (SCRs), and other semiconductor devices. This function tests a semiconductor junction by sending a current through the junction, then measuring the junction's voltage drop. A good silicon junction drops between 0.5 V and 0.8 V.

To test a diode out of a circuit, set up the Meter as shown in Figure 7. For forward-bias readings on any semiconductor component, place the red test lead on the component's positive terminal and place the black lead on the component's negative terminal.

In a circuit, a good diode should still produce a forward-bias reading of 0.5 V to 0.8 V; however, the reverse-bias reading can vary depending on the resistance of other pathways between the probe tips.

A short beep sounds if the diode is good ($< .85$ V). A continuous beep sounds if the reading is $\leq .100$ V. This reading would indicate a short circuit. The display shows "OL" if the diode is open.

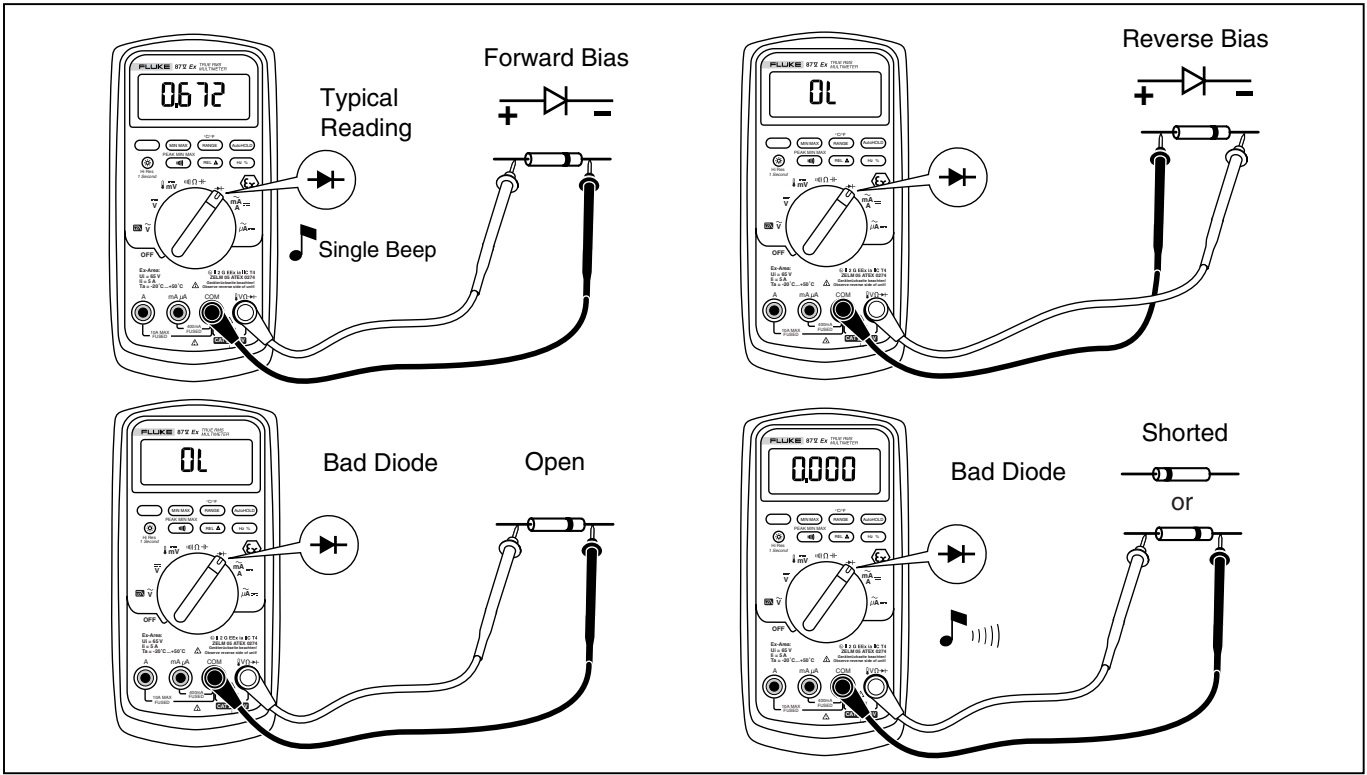

Figure 7. Testing a Diode

ecg9f.eps

Measuring AC or DC Current

⚠ ⚠ Warning

To avoid possible electric shock or personal injury:

- Never attempt an in-circuit current measurement where the open-circuit potential to earth is greater than 1000 V. You may damage the Meter or be injured if the fuse blows during such a measurement.
- Never measure currents greater than 5 amps while using the Meter in an Ex-hazardous area.

⚠ Caution

To avoid possible damage to the Meter or to the equipment under test:

- Check the Meter's fuses before measuring current.
- Use the proper terminals, function, and range for all measurements.
- Never place the probes across (in parallel with) any circuit or component when the leads are plugged into the current terminals.

To measure current, you must break the circuit under test, then place the Meter in series with the circuit.

The Meter's current ranges are 600.0 μ A, 6000 μ A, 60.00 mA, 400.0 mA, 6000 mA, and 10 A. AC current is displayed as an rms value.

To measure current, refer to Figure 8 and proceed as follows:

1. Turn off power to the circuit. Discharge all high-voltage capacitors.
2. Insert the black lead into the **COM** terminal. For currents between 6 mA and 400 mA, insert the red lead into the **mA/ μ A** terminal. For currents above 400 mA, insert the red lead into the **A** terminal.

Note

To avoid blowing the Meter's 400 mA fuse, use the mA/ μ A terminal only if you are sure the current is less than 400 mA continuously or less than 600 mA for 18 hours or less.

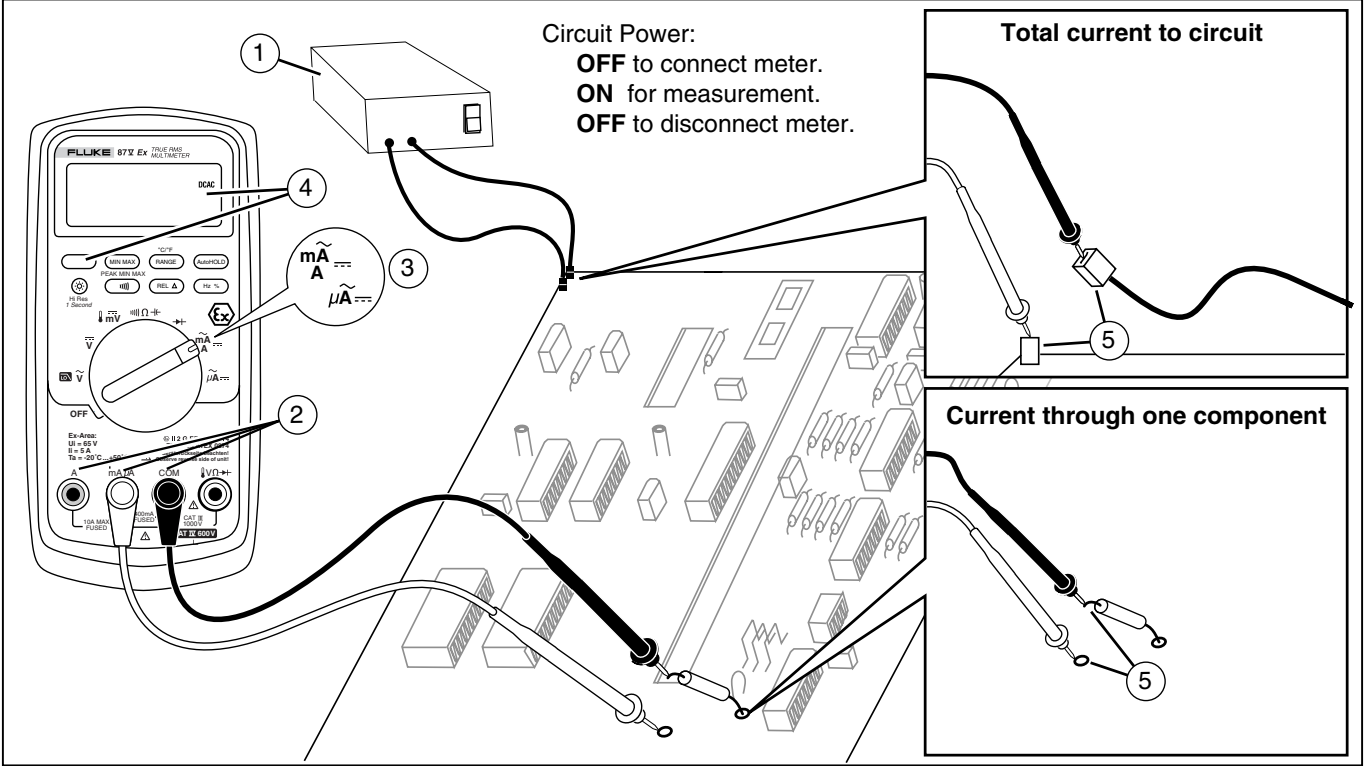



Figure 8. Measuring Current

ecg7f.eps

87V Ex

Users Manual

3. If you are using the **A** terminal, set the rotary switch to mA/A. If you are using the **mA/μA** terminal, set the rotary switch to μA for currents below 6000 μA (6 mA), or mA/A for currents above 6000 μA.
4. To measure dc current, press .
5. Break the circuit path to be tested. Touch the black probe to the more negative side of the break; touch the red probe to the more positive side of the break. Reversing the leads will produce a negative reading, but will not damage the Meter.
6. Turn on power to the circuit; then read the display. Be sure to note the unit given at the right side of the display (μA, mA, or A).
7. Turn off power to the circuit and discharge all high-voltage capacitors. Remove the Meter and restore the circuit to normal operation.



The following are some tips for measuring current:

- If the current reading is 0 and you are sure the Meter is set up correctly, test the Meter's fuses as described under "Testing the Fuses".
- A current Meter drops a small voltage across itself, which might affect circuit operation. You can calculate this burden voltage using the values listed in the Current Function specifications table.

Measuring Frequency

The Meter measures the frequency of a voltage or current signal by counting the number of times the signal crosses a threshold level each second.

Table 6 summarizes the trigger levels and applications for measuring frequency using the various ranges of the Meter's voltage and current functions.

To measure frequency, connect the Meter to the signal source; then press . Pressing  switches the trigger slope between + and -, as indicated by the symbol at the left side of the display (refer to Figure 9 under "Measuring Duty Cycle"). Pressing  stops and starts the counter.

The Meter autoranges to one of five frequency ranges: 199.99 Hz, 1999.9 Hz, 19.999 kHz, 199.99 kHz, and greater than 200 kHz. For frequencies below 10 Hz, the display is updated at the frequency of the input. Below 0.5 Hz, the display may be unstable.

The following are some tips for measuring frequency:

- If a reading shows as 0 Hz or is unstable, the input signal may be below or near the trigger level. You can usually correct these problems by selecting a lower range, which increases the sensitivity of the Meter. In the \bar{V} function, the lower ranges also have lower trigger levels.
- If a reading seems to be a multiple of what you expect, the input signal may be distorted. Distortion can cause multiple triggerings of the frequency counter. Selecting a higher voltage range might solve this problem by decreasing the sensitivity of the Meter. You can also try selecting a dc range, which raises the trigger level. In general, the lowest frequency displayed is the correct one.

Table 6. Functions and Trigger Levels for Frequency Measurements

Function	Range	Approximate Trigger Level	Typical Application
\tilde{V}	6 V, 60 V, 600 V, 1000 V	$\pm 5\%$ of scale	Most signals.
\tilde{V}	600 mV	± 30 mV	High-frequency 5 V logic signals. (The dc-coupling of the \tilde{V} function can attenuate high-frequency logic signals, reducing their amplitude enough to interfere with triggering.)
$m\bar{\bar{V}}$	600 mV	40 mV	Refer to the measurement tips given before this table.
$\bar{\bar{V}}$	6 V	1.7 V	5 V logic signals (TTL).
$\bar{\bar{V}}$	60 V	4 V	Automotive switching signals.
$\bar{\bar{V}}$	600 V	40 V	Refer to the measurement tips given before this table.
$\bar{\bar{V}}$	1000 V	100 V	
Ω , \rightarrow , \rightarrow	Frequency counter characteristics are not available or specified for these functions.		
$A\sim$	All ranges	$\pm 5\%$ of scale	AC current signals.
$\mu A\bar{\bar{=}}$	600 μ A, 6000 μ A	30 μ A , 300 μ A	Refer to the measurement tips given before this table.
$mA\bar{\bar{=}}$	60 mA, 400 mA	3.0 mA , 30 mA	
$A\bar{\bar{=}}$	6 A, 10 A	.30 A, 3.0 A	

Measuring Duty Cycle

Duty cycle (or duty factor) is the percentage of time a signal is above or below a trigger level during one cycle (Figure 9). The duty cycle mode is optimized for measuring the on or off time of logic and switching signals. Systems such as electronic fuel injection systems and switching power supplies are controlled by pulses of varying width, which can be checked by measuring duty cycle.

To measure duty cycle, set up the Meter to measure frequency; then press Hz a second time. As with the

frequency function, you can change the slope for the Meter's counter by pressing .

For 5 V logic signals, use the 6 V dc range. For 12 V switching signals in automobiles, use the 60 V dc range. For sine waves, use the lowest range that does not result in multiple triggering. (Normally, a distortion-free signal can be up to ten times the amplitude of the selected voltage range.)

If a duty cycle reading is unstable, press MIN MAX; then scroll to the AVG (average) display.

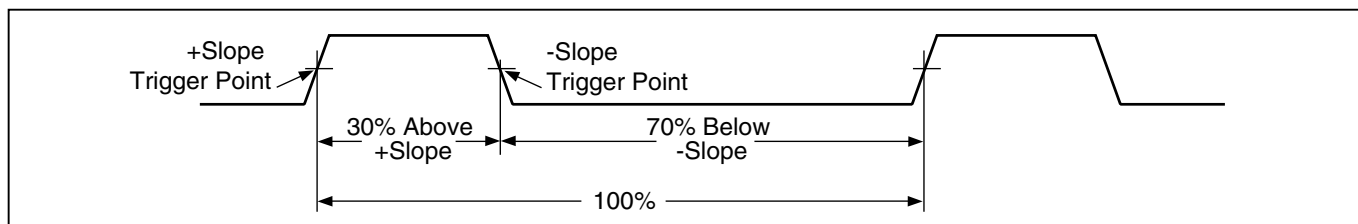



Figure 9. Components of Duty Cycle Measurements

iy3f.eps

Determining Pulse Width

For a periodic waveform (its pattern repeats at equal time intervals), you can determine the amount of time that the signal is high or low as follows:

1. Measure the signal's frequency.
2. Press  a second time to measure the signal's duty cycle. Press  to select a measurement of the signal's positive or negative pulse, refer to Figure 9.
3. Use the following formula to determine the pulse width:

$$\text{Pulse Width (in seconds)} = \frac{\% \text{ Duty Cycle} \div 100}{\text{Frequency}}$$

Bar Graph

The analog bar graph functions like the needle on an analog meter, but without the overshoot. The bar graph updates 40 times per second. Because the graph responds 10 times faster than the digital display, it is useful for making peak and null adjustments and observing rapidly changing inputs. The graph is not shown for capacitance, frequency counter functions, temperature, or peak min max.



The number of lit segments indicates the measured value and is relative to the full-scale value of the selected range.

In the 60 V range, for example, the major divisions on the scale represent 0, 15, 30, 45, and 60 V. An input of -30 V lights the negative sign and the segments up to the middle of the scale.

The bar graph also has a zoom function, as described under "Zoom Mode".

Zoom Mode (Power Up Option Only)

To use the Rel Zoom Bar Graph:



1. Hold down  while turning the Meter on. The display reads “REL”.
2. Select the relative mode by pressing  again.
3. The center of the bar graph now represents zero and the sensitivity of the bar graph increases by a factor of 10. Measured values more negative than the stored reference activate segments to the left of center; values more positive activate segments to the right of center.

Uses for the Zoom Mode

The relative mode, combined with the increased sensitivity of the bar graph's zoom mode, helps you make fast and accurate zero and peak adjustments.

For zero adjustments, set the Meter to the desired function, short the test leads together, press ; then connect the leads to the circuit under test. Adjust the circuit's variable component until the display reads zero. Only the center segment on the zoom bar graph is lit.

For peak adjustments, set the Meter to the desired function, connect the leads to the circuit under test; then press . The display reads zero. As you adjust for a positive or negative peak, the bar graph length increases

to the right or left of zero. If an overrange symbol lights ( ) , press  twice to set a new reference; then continue with the adjustment.

HiRes Mode

Pressing  for one second causes the Meter to enter the high-resolution (HiRes), 4-1/2 digit mode. Readings are displayed at 10 times the normal resolution with a maximum display of 19,999 counts. The HiRes mode works in all modes except capacitance, frequency counter functions, temperature, and the 250 μs (peak) MIN MAX modes.

To return to the 3-1/2 digit mode, press  again for one second.

MIN MAX Recording Mode

The MIN MAX mode records minimum and maximum input values. When the inputs go below the recorded minimum value or above the recorded maximum value, the Meter beeps and records the new value. This mode can be used to capture intermittent readings, record maximum readings while you are away or record readings while you are operating the equipment under test and cannot watch the Meter. MIN MAX mode can also calculate an average of all readings taken since the MIN MAX mode was activated. To use MIN MAX mode, refer to the functions in Table 7.

Response time is the length of time an input must stay at a new value to be recorded. A shorter response time captures shorter events, but with decreased accuracy. Changing the response time erases all recorded readings. The Meter has 100 millisecond, and 250 μ s (peak) response times. The 250 μ s response time is indicated by "**PEAK**" on the display.

The 100 millisecond response time is best for recording power supply surges, inrush currents, and finding intermittent failures.

The true average value (AVG) displayed in the 100 ms mode is the mathematical integral of all readings taken since the start of recording (overloads are discarded). The average reading is useful for smoothing out unstable

inputs, calculating power consumption, or estimating the percentage of time a circuit is active.

Min Max records the signal extremes lasting longer than 100 ms.

Peak records the signal extremes lasting longer than 250 μ s.

Smooth Feature (Power Up Option Only)

When the input signal changes rapidly, "smoothing" provides a steadier reading on the display.

To use the smooth feature:







1. Hold down **RANGE** while turning the Meter on. The display will read "5---" until **RANGE** is released.
2. The smooth icon () will appear on the left side of the display to let you know that smoothing is active.

Table 7. MIN MAX Functions

Button	MIN MAX Function
	Enter MIN MAX recording mode. The Meter is locked in the range displayed before you entered MIN MAX mode. (Select the desired measurement function and range before entering MIN MAX.) The Meter beeps each time a new minimum or maximum value is recorded.
 (while in MIN MAX mode)	Step through maximum (MAX), minimum (MIN), average (AVG) and present values.
 PEAK MIN MAX	Select 100 ms or 250 μ s response time. (The 250 μ s response time is indicated by PEAK on the display.) Stored values are erased. The present and AVG (average) values are not available when 250 μ s is selected.
	Stop recording without erasing stored values. Press again to resume recording.
 (hold for 1 second)	Exit MIN MAX mode. Stored values are erased. The Meter stays in the selected range.



AutoHOLD Mode

Warning

To avoid possible electric shock or personal injury, do not use AutoHOLD mode to determine that circuits are without power. The AutoHOLD mode will not capture unstable or noisy readings.

The AutoHOLD mode captures the present reading on the display. When a new, stable reading is detected, the Meter beeps and displays the new reading. To enter or exit AutoHOLD mode, press .

Relative Mode

Selecting relative mode () causes the Meter to zero the display and store the present reading as the reference for subsequent measurements. The Meter is locked into the range selected when you pressed . Press  again to exit this mode.

In relative mode, the reading shown is always the difference between the present reading and the stored reference value. For example, if the stored reference value is 15.00 V and the present reading is 14.10 V, the display shows -0.90 V.

Maintenance

⚠ ⚠ Warning

To avoid possible electric shock or personal injury, servicing not covered in this manual should be performed only by the manufacturer. Repair or service by others may void the ATEX certification of this Meter.

General Maintenance

Periodically wipe the case with a damp cloth. Do not use abrasives or solvents.

Caution

To avoid weakening the case and possibly developing cracks, do not use Acetone to clean the Meter

Dirt or moisture in the terminals can affect readings and can falsely activate the Input Alert feature. Clean the terminals as follows:

1. Turn the Meter off and remove all test leads.
2. Shake out any dirt that may be in the terminals.
3. Soak a new swab with a cleaning and oiling agent (such as WD-40). Work the swab around in each terminal. The oiling agent insulates the terminals from moisture-related activation of the Input Alert feature.

Fuse Test

If a test lead is plugged into the **mA/μA** or **A** terminal and the rotary switch is turned to a non-current function, the Meter chirps and flashes “**⚠ ⚠**” if the fuse associated with that current terminal is good. If the Meter does not chirp or flash “**⚠ ⚠**”, the fuse is bad and must be replaced. Refer to Table 9 for the appropriate replacement fuse.

To test the quality of the fuse:
before measuring current, test the appropriate fuse as shown in Figure 10. If the tests give readings other than those shown, have the Meter serviced.

⚠ ⚠ Warning

To avoid electrical shock or personal injury, remove the test leads and any input signals before replacing the battery or fuses. To prevent damage or injury, install ONLY approved fuses shown in Table 9.

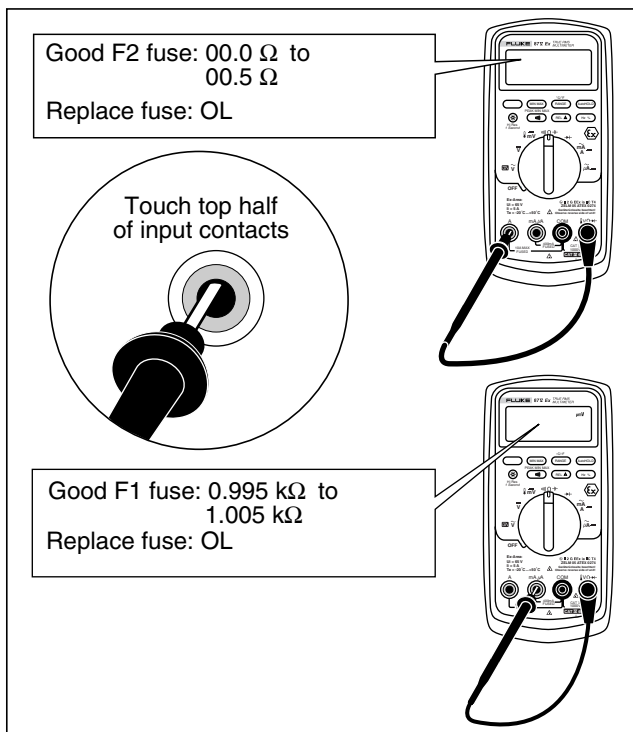

Figure 10. Testing the Current Fuses

Replacing the Battery

Replace the Meter's 9 volt battery with only approved batteries found in Table 8.

⚠ ⚠ Warning

Do not change or install the battery within the Ex-hazardous area.

To avoid false readings, which could lead to possible electric shock or personal injury, replace the battery as soon as the battery indicator (⚡) appears. If the display shows "batt" the Meter will not function until the battery is replaced.

Use only a single 9 volt battery, properly installed to power the Meter. See the table on the next page for a list of approved batteries.

Replace the battery as follows, refer to Figure 11:

1. Turn the rotary switch to OFF and remove the test leads from the terminals.
2. Remove the battery door by using a standard-blade screwdriver to turn the battery door screws one-quarter turn counterclockwise.
3. Replace the battery and the battery door. Secure the door by turning the screws one-quarter turn clockwise.

Table 8. Approved Batteries

Battery Description	Manufacturer	Type
Alkaline Energizer Energizer No. 522	Eveready	6LR61
Alkaline	Daimon	6LR61
Alkaline Alkaline Ultra Professional Alkaline Battery Procell Plus MN1604 6LR61 Procell MN1604 6LR61 Ultra M3 MN1604 6LR61	Duracell	6LR61
Ucar Gold 6LR61	Energizer	6LR61
Alkaline 4822 Alkaline Universal No. 4022 Alkaline Electric Power No. 8022 Electric Power No.8022 High Energy No.4922 Industrial Alkaline No.4022	Varta	6LR61

Table 8. Approved Batteries (cont.)

Battery Description	Manufacturer	Type
Alkaline Power Line Industrial Battery Industrial Alkaline 6LR61 Powermax 6LR61	Panasonic	6LR61
Super Alkaline 1604A	GP	6LR61

Replacing the Fuses

⚠ Warning

Do not remove or install fuses while in Ex-hazardous areas.

To avoid personal injury or damage to the Meter, install only approved fuses shown in Table 9. The fuses are an integral part of the Meter's IS protection circuits. Using non approved fuses voids the ATEX safety certification.

Referring to Figure 11, examine or replace the Meter's fuses as follows:

1. Turn the rotary switch to OFF and remove the test leads from the terminals.

87V Ex

Users Manual

2. Remove the battery door by using a standard-blade screwdriver to turn the battery door screws one-quarter turn counterclockwise.
3. Remove the three Phillips-head screws from the case bottom and turn the case over.
4. Gently push up the input terminal-end of the top case from inside of the battery compartment to separate the two halves of the case.
5. Remove the fuse by gently prying one end loose, then sliding the fuse out of its bracket.
6. Install **ONLY** specified replacement fuses shown in Table 9.
7. Verify that the rotary switch and the circuit board switch are in the OFF position.
8. Replace the case top, ensuring that the gasket is properly seated and case snaps together above the LCD (item ①).
9. Reinstall the three screws and the battery door. Secure the door by turning the screws one-quarter turn clockwise.

Service and Parts

If the Meter fails, check the battery and fuses. Review this manual to verify proper use of the Meter.

Replacement parts and accessories are shown in Tables 9 and 10 and Figure 12.

To order parts and accessories, refer to “Contacting Fluke”.

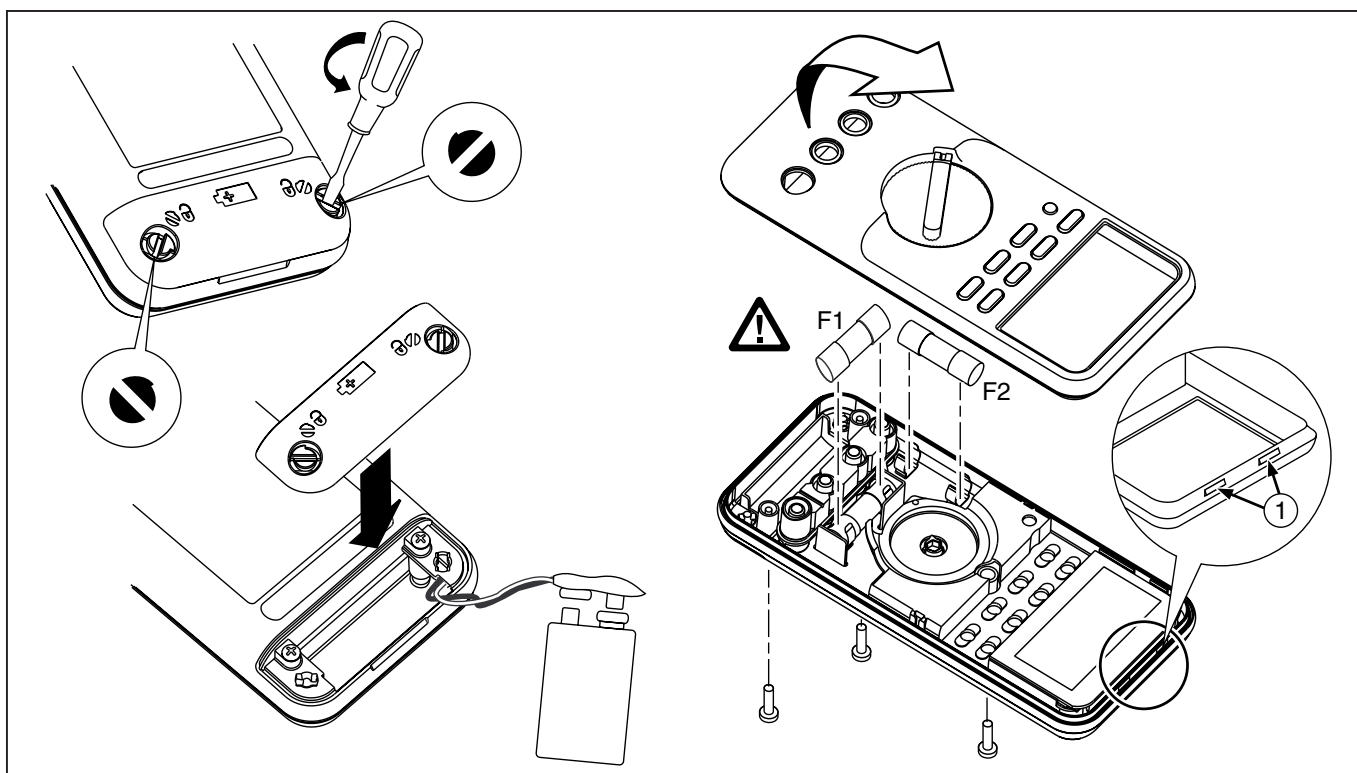





Figure 11. Battery and Fuse Replacement

aom12f.eps

Table 9. Replacement Parts

Item	Description	Qty.	Fluke Part or Model Number
BT1 	Battery, 9 V (see Table 8)	1	822270
F1 	Fuse, 0.44 A, 1000 V, FAST	1	943121
F2 	Fuse, 11 A, 1000 V, FAST	1	803293
H1-3	Screw, Case	3	832246
MP1	Shock absorber	1	828541
MP2-3	Foot, Non-Skid	2	824466
MP4	Ex-Holster (Red)	1	2520563
MP5	Battery Door	1	2520595
AC72	Alligator Clip, Black	1	1670652
AC72	Alligator Clip, Red	1	1670641
TL75	Test Lead Set	1	855742
MP6-7	Access Door Fastener	2	948609
80BK	Thermocouple Assembly, K-Type, Beaded, Molded Dual Banana Plug, Coiled	1	1273113
NA	Tiltstand of the Ex holster	1	2520056
TM1	87V Ex Users Manual (English, French, & German)	1	2518115
TM2	CD ROM,87V Ex Users Manual	1	2520777

 To ensure safety, use exact replacement only.

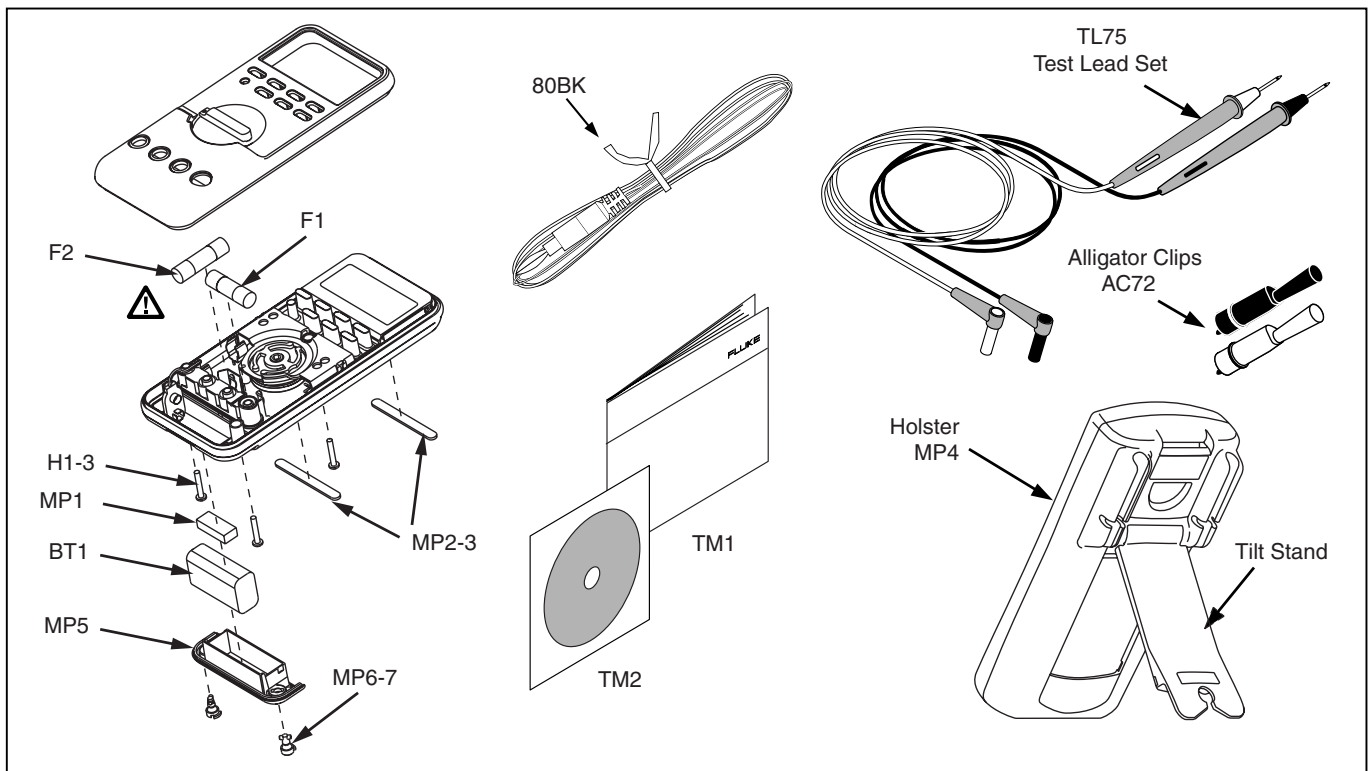

ecg015c.eps

Figure 12. Replaceable Parts

Table 10. Specified Accessories

Item	Description
AC72	Alligator Clips for use with TL75 test lead set
AC220	Safety Grip, Wide-Jaw Alligator Clips
80BK	Thermocouple Assembly, K-Type, Beaded, Molded Dual Banana Plug, Coiled
TL76	4 mm Diameter Test Leads
TL220	Industrial Test Lead Set
TL224	Test Lead Set, Heat-Resistant Silicone
TP1	Test Probes, Flat Blade, Slim Reach
TP4	Test Probes, 4 mm diameter, Slim Reach

Fluke accessories are available from an authorized Fluke distributor.

General Specifications

Maximum Voltage between any Terminal and Earth Ground: 1000 V rms

▲ Fuse Protection for mA or μ A inputs: 0.44 A, 1000 V FAST Fuse

▲ Fuse Protection for A input: 11 A, 1000 V FAST Fuse

Display: Digital: 6000 counts updates 4/sec; (Model 87 also has 19,999 counts in high-resolution mode).

Analog Bargraph: 33 segments, updates 40/sec. Frequency: 19,999 counts, updates 3/sec at > 10 Hz

Temperature: Operating: -20 °C to +50 °C; Storage: -40 °C to +60 °C

Altitude: Operating: 2000 m; Storage: 10,000 m

Temperature Coefficient: 0.05 x (specified accuracy)/ °C (< 18 °C or > 28 °C)

Electromagnetic Compatibility: In an RF field of 3 V/m total accuracy = specified accuracy + 20 counts

Except: 600 μ A dc range total accuracy=specified accuracy + 60 counts.

Temperature not specified.

Relative Humidity: 0 % to 80 % (0 °C to 35 °C); 0 % to 70 % (35 °C to 50 °C)

Battery Type: 9 V, 6LR61 according to IEC (Use only approved batteries listed in Table 8)

Battery Life: 400 hrs typical with alkaline (with backlight off)

Vibration: Per MIL-PRF-28800 for a Class 2 instrument

Shock: 1 Meter drop per IEC 61010-1:2001

Size (HxWxL): 1.25 in x 3.41 in x 7.35 in (3.1 cm x 8.6 cm x 18.6 cm)

Size with Holster and Flex-Stand: 2.06 in x 3.86 in x 7.93 in (5.2 cm x 9.8 cm x 20.1 cm)

Weight with Holster and Flex-Stand: 23.3 oz (660 g)

Safety: Complies with ANSI/ISA S82.01-2004, CSA 22.2 No. 1010.1:2004 to 1000 V Overvoltage Category III, IEC 664 to 600 V Overvoltage Category IV. Licensed by TÜV to EN61010-1.  Directive 1992/92/EC (ATEX 137)

Detailed Specifications

For all detailed specifications:

Accuracy is given as \pm ([% of reading] + [number of least significant digits]) at 18 °C to 28 °C, with relative humidity up to 90 %, for a period of one year after calibration.

In the 4 ½-digit mode, multiply the number of least significant digits (counts) by 10. AC conversions are ac-coupled and valid from 3 % to 100 % of range. The Meter is true rms responding. AC crest factor can be up to 3 at full scale, 6 at half scale. For non-sinusoidal wave forms add $-(2 \% \text{ Rdg} + 2 \% \text{ full scale})$ typical, for a crest factor up to 3.

AC Voltage Function

Function	Range	Resolution	Accuracy					
			45 – 65 Hz	30 - 200 Hz	200 - 440 Hz	440 Hz - 1 kHz	1 - 5 kHz	5 - 20 kHz ^[1]
\tilde{V} ^[2,4]	600.0 mV	0.1 mV	$\pm (0.7 \% + 4)$	$\pm (1.0 \% + 4)$	$\pm (1.0 \% + 4)$	$\pm (1.0 \% + 4)$	$\pm (2.0 \% + 4)$	$\pm (2.0 \% + 20)$
	6.000 V	0.001 V						
	60.00 V	0.01 V	$\pm (0.7 \% + 2)$				$\pm (2.0 \% + 4)$ ^[3]	unspecified
	600.0 V	0.1 V						
1000 V	1 V					unspecified	unspecified	
	Low pass filter		$\pm (0.7 \% + 2)$	$\pm (1.0 \% + 4)$	+1 % + 4 -6 % - 4 ^[5]	unspecified	unspecified	unspecified

[1] Below 10 % of range, add 12 counts.
 [2] The Meter is a true rms responding meter. When the input leads are shorted together in the ac functions, the Meter may display a residual reading between 1 and 30 counts. A 30 count residual reading will cause only a 2-digit change for readings over 3 % of range. Using REL to offset this reading may produce a much larger constant error in later measurements.
 [3] Frequency range: 1 kHz to 2.5 kHz.
 [4] A residual reading of up to 13 digits with leads shorted, will not affect stated accuracy above 3 % of range.
 [5] Specification increases from -1% at 200 Hz to -6% at 440 Hz when filter is in use.

DC Voltage, Resistance, and Conductance Function

Function	Range	Resolution	Accuracy
\bar{V}	6.000 V	0.001 V	$\pm (0.05 \% + 1)$
	60.00 V	0.01 V	$\pm (0.05 \% + 1)$
	600.0 V	0.1 V	$\pm (0.05 \% + 1)$
	1000 V	1 V	$\pm (0.05 \% + 1)$
\bar{mV}	600.0 mV	0.1 mV	$\pm (0.1 \% + 1)$
Ω	600.0 Ω	0.1 Ω	$\pm (0.2 \% + 2)^{[1]}$
	6.000 k Ω	0.001 k Ω	$\pm (0.2 \% + 1)$
	60.00 k Ω	0.01 k Ω	$\pm (0.2 \% + 1)$
	600.0 k Ω	0.1 k Ω	$\pm (0.6 \% + 1)$
	6.000 M Ω	0.001 M Ω	$\pm (0.6 \% + 1)$
	50.00 M Ω	0.01 M Ω	$\pm (1.0 \% + 3)^{[2]}$
nS	60.00 nS	0.01 nS	$\pm (1.0 \% + 10)^{[1,2]}$
<p>[1] When using the REL Δ function to compensate for offsets.</p> <p>[2] Add 0.5 % of reading when measuring above 30 MΩ in the 50 MΩ range, and 20 counts below 33 nS in the 60 nS range.</p>			

87V Ex*Users Manual*

Temperature

Temperature	Resolution	Accuracy ^[1,2]
-200 °C to +1090 °C	0.1 °C	1 % + 10
-328 °F to +1994 °F	0.1 °F	1 % + 18

[1] Does not include error of the thermocouple probe.

[2] Accuracy specification assumes ambient temperature stable to ± 1 °C. For ambient temperature changes of ± 5 °C, rated accuracy applies after 1 hour.

Current Function

Function	Range	Resolution	Accuracy ^[1, 2]	Burden Voltage (typical)
mA A~ (45 Hz to 2 kHz)	60.00 mA	0.01 mA	$\pm(1.0\% + 2)$	1.8 mV/mA
	400.0 mA ^[4]	0.1 mA	$\pm(1.0\% + 2)$	1.8 mV/mA
	6.000 A	0.001 A	$\pm(1.0\% + 2)$	0.03 V/A
	10.00 A ^[3]	0.01 A	$\pm(1.0\% + 2)$	0.03 V/A
mA A=	60.00 mA	0.01 mA	$\pm(0.2\% + 4)$	1.8 mV/mA
	400.0 mA ^[4]	0.1 mA	$\pm(0.2\% + 2)$	1.8 mV/mA
	6.000 A	0.001 A	$\pm(0.2\% + 4)$	0.03 V/A
	10.00 A ^[3]	0.01 A	$\pm(0.2\% + 2)$	0.03 V/A
μA ~ (45 Hz to 2 kHz)	600.0 μA	0.1 μA	$\pm(1.0\% + 2)$	100 μV/μA
	6000 μA	1 μA	$\pm(1.0\% + 2)$	100 μV/μA
μA =	600.0 μA	0.1 μA	$\pm(0.2\% + 4)$	100 μV/μA
	6000 μA	1 μA	$\pm(0.2\% + 2)$	100 μV/μA

[1] AC conversions are ac coupled, true rms responding, and valid from 3 % to 100 % of range, except 400 mA range (5 % to 100 % of range) and 10 A range (15 % to 100 % of range).

[2] The Meter is a true rms responding meter. When the input leads are shorted together in the ac functions, the Meter may display a residual reading between 1 and 30 counts. A 30 count residual reading will cause only a 2 digit change for readings over 3 % of range. Using REL to offset this reading may produce a much larger constant error in later measurements

[3] Δ 10 A continuous up to 35 °C; < 20 minutes on, 5 minutes off at 35 °C to 55 °C. 20 A for 30 seconds maximum; > 10 A unspecified.

[4] 400 mA continuous; 600 mA for 18 hrs maximum.

87V Ex

Users Manual

Capacitance and Diode Function

Function	Range	Resolution	Accuracy
↔	10.00 nF	0.01 nF	$\pm (1 \% + 2)^{[1]}$
	100.0 nF	0.1 nF	$\pm (1 \% + 2)^{[1]}$
	1.000 μ F	0.001 μ F	$\pm (1 \% + 2)$
	10.00 μ F	0.01 μ F	$\pm (1 \% + 2)$
	100.0 μ F	0.1 μ F	$\pm (1 \% + 2)$
	9999 μ F	1 μ F	$\pm (1 \% + 2)$
→	3.000 V	0.001 V	$\pm (2 \% + 1)$

[1] With a film capacitor or better, using Relative mode to zero residual.

Frequency Counter

Function	Range	Resolution	Accuracy
Frequency (0.5 Hz to 200 kHz, pulse width > 2 μ s)	199.99	0.01 Hz	$\pm (0.005 \% + 1)$
	1999.9	0.1 Hz	$\pm (0.005 \% + 1)$
	19.999 kHz	0.001 kHz	$\pm (0.005 \% + 1)$
	199.99 kHz	0.01 kHz	$\pm (0.005 \% + 1)$
	> 200 kHz	0.1 kHz	unspecified

Frequency Counter Sensitivity and Trigger Levels

Input Range ^[1]	Minimum Sensitivity (RMS Sine wave)		Approximate Trigger Level (DC Voltage Function)
	5 Hz - 20 kHz	0.5 Hz - 200 kHz	
600 mV dc	70 mV (to 400 Hz)	70 mV (to 400 Hz)	40 mV
600 mV ac	150 mV	150 mV	—
6 V	0.3 V	0.7 V	1.7 V
60 V	3 V	7 V (≤ 140 kHz)	4 V
600 V	30 V	70 V (≤ 14.0 kHz)	40 V
1000 V	100 V	200 V (≤ 1.4 kHz)	100 V
Duty Cycle Range	Accuracy		
0.0 to 99.9 %	Within $\pm (0.2\%$ per kHz + 0.1 %) for rise times < 1 μ s.		
[1] Maximum input for specified accuracy = 10X Range or 1000 V.			

Electrical Characteristics of the Terminals

Function	Overload Protection ^[1]	Input Impedance (nominal)	Common Mode Rejection Ratio (1 k Ω unbalance)		Normal Mode Rejection					
\bar{V}	1000 V rms	10 M Ω < 100 pF	> 120 dB at dc, 50 Hz or 60 Hz		> 60 dB at 50 Hz or 60 Hz					
\bar{mV}	1000 V rms	10 M Ω < 100 pF	> 120 dB at dc, 50 Hz or 60 Hz		> 60 dB at 50 Hz or 60 Hz					
\tilde{V}	1000 V rms	10 M Ω < 100 pF (ac-coupled)	> 60 dB, dc to 60 Hz							
			Open Circuit Test Voltage	Full Scale Voltage		Typical Short Circuit Current				
		To 6.0 M Ω		50 M Ω or 60 nS	600 Ω	6 k	60 k	600 k	6 M	50 M
Ω	1000 V rms	< 7.9 V dc	< 4.1 V dc	< 4.5 V dc	1 mA	100 μ A	10 μ A	1 μ A	1 μ A	0.5 μ A
\rightarrow	1000 V rms	< 3.9 V dc	3.000 V dc		0.6 mA typical					
[1] 10 ⁶ V Hz max										

MIN MAX Recording

Nominal Response	Accuracy
100 ms to 80 %	Specified accuracy ± 12 counts for changes > 200 ms in duration (± 40 counts in ac with beeper on)
100 ms to 80 % (dc functions) 120 ms to 80 % (ac functions) 250 μ s (peak) ^[1]	Specified accuracy ± 12 counts for changes > 200 ms in duration Specified accuracy ± 40 counts for changes > 350 ms and inputs > 25 % of range Specified accuracy ± 100 counts for changes > 250 μ s in duration (add ± 100 counts for readings over 6000 counts) (add ± 100 counts for readings in Low Pass mode)
[1] For repetitive peaks: 1 ms for single events.	

Test and certification body
ZELM Ex

EC-Type Examination Certificate

- (1) **Equipment and Protected Systems Intended for Use in Potentially Explosive Atmospheres - Directive 94/9/EC**
- (2) **EC-type examination certificate number**
ZELM 05 ATEX 0274
- (4) **Equipment: Explosion-protected Multimeter Type 87V Ex**
- (5) **Manufacturer: ecom Instruments GmbH**
- (6) **Address: D-97959 Assamstadt**
- (7) The design of this equipment and its various approved embodiments are defined in the attachment to this type examination certificate.
- (8) The Pr f.- und Zertifizierungsstelle ZELM, notified body no. 0820 in accordance with Article 9 of the EC Council Directive dated March 23, 1994 (94/9/EC), certifies that this equipment has been found to conform with the essential health and safety requirements for the design and construction of equipment and protected systems for proper intended use in potentially explosive areas in accordance with Appendix II of the directive.

The results of the test are documented in the confidential test report no. ZELM Ex 0390512412.

- (9) The essential health and safety requirements are met by virtue of conformity with **EN 60079-0 :2004** **EN 50020:2002**
- (10) If the certification number is followed by an X, then this indicates that special conditions exist for the safe operation of the equipment. These special conditions are contained in the attachment to this certificate.
- (11) This EC-type examination certificate only refers to the construction/design, checking and testing of the specified equipment or protection system in accordance with Directive 94/9/EC. Further requirements contained in this directive may apply with regard to the manufacturing process and the supply of the equipment or protected system. Such requirements are not covered by this certification.
- (12) The equipment must be labelled with the following information:

Ex II 2 G EEx ia IIC T4

Certification body ZELM

Signature

Dipl.-Ing. Harald Zein

Braunschweig, August 4, 2005

Page 1/3

EC-type examination certificates without signature and stamp are not valid.
This EC-type examination certificate may only be circulated without alteration. Extracts or alterations are subject to approval by the Pr f.- und Zertifizierungsstelle ZELM Ex.

Pr f.- und Zertifizierungsstelle ZELM Ex Siekgraben 56 D-38124 Braunschweig

Test and certification body

ZELM Ex Attachment

- (13)
(14) EC-type examination certificate ZELM 05 ATEX 0274

(15) Description of the equipment

The explosion-protected Multimeter Type 87V Ex serves to make mobile measurements on intrinsically safe and non-intrinsically safe circuits.
The equipment is fitted with a power supply in the form of an internal battery.
The permitted ambient temperature is -20 C to +50 C.

Electrical data

Supply (Internal battery)
1 unit Block battery according to IEC 6LR 61 - U = 9V
The internal circuits are intrinsically safe.

Measuring circuit
type of ignition protection: intrinsically safe, EEx ia IIC
for measuring intrinsically safe circuits

Maximum values: $U_i = 65 \text{ V}$
 $I_i = 5 \text{ A}$

The effective internal capacitance and inductance are negligibly small.

Maximum output values at the voltage measuring input

$U_o = 10.35 \text{ V}$
 $I_o = 4 \text{ mA}$
 $C_o = 2.52 \text{ F}$
 $L_o = 100 \text{ mH}$

Maximum output values at the current-measuring inputs

$U_o = 2.8 \text{ V}$
 $I_o = 68 \text{ mA}$
 $C_o = 1000 \text{ F}$
 $L_o = 8 \text{ mH}$

Measurements on non-intrinsically safe circuits

Measurement inputs Maximum values: $U_i = 1000 \text{ V}$
 $I_i = 10 \text{ A}$

Test and certification body ZELM Ex

Attachment to EC-type examination certificate ZELM 05 ATEX 0274

(16) Test report no.
ZELM Ex 0390512412

(17) Note
The equipment must not be opened within the Ex-area.
The multimeter must be operated within the potentially explosive area using the designated holster only.
Only batteries successfully type-approved according to paragraph 10.9 of EN 50020:2002 are permitted. The manufacturers and types are listed in the operating instructions.
Changing the battery is allowed only outside the potentially explosive area.
Observance of the following is mandatory:
After each measurement on non-intrinsically safe circuits, observe a waiting period of 3 minutes before taking the equipment into the Ex-area again.
The operating instructions must be followed.

(18) Essential health and safety requirements
satisfied by virtue of the standards

Certification body ZELM Braunschweig, August 4, 2005

Signature

Dipl.-Ing. Harald Zelm

Page 3/3

EC-type examination certificates without signature and stamp are not valid.
This EC-type examination certificate may only be circulated with the alteration. Extracts or alterations are subject to approval by the Prf- und Zertifizierungsstelle ZELM Ex
Prf- und Zertifizierungsstelle ZELM Ex - Siekgraben 56 D-38124 Braunschweig