

FLUKE®

8808A

Digital Multimeter

Getting Started Manual

Specifications

PN 2716412

July 2007

© 2007 Fluke Corporation, All rights reserved. Printed in China
All product names are trademarks of their respective companies.

LIMITED WARRANTY AND LIMITATION OF LIABILITY

Each Fluke product is warranted to be free from defects in material and workmanship under normal use and service. The warranty period is one year and begins on the date of shipment. Parts, product repairs, and services are warranted for 90 days. This warranty extends only to the original buyer or end-user customer of a Fluke authorized reseller, and does not apply to fuses, disposable batteries, or to any product which, in Fluke's opinion, has been misused, altered, neglected, contaminated, or damaged by accident or abnormal conditions of operation or handling. Fluke warrants that software will operate substantially in accordance with its functional specifications for 90 days and that it has been properly recorded on non-defective media. Fluke does not warrant that software will be error free or operate without interruption.

Fluke authorized resellers shall extend this warranty on new and unused products to end-user customers only but have no authority to extend a greater or different warranty on behalf of Fluke. Warranty support is available only if product is purchased through a Fluke authorized sales outlet or Buyer has paid the applicable international price. Fluke reserves the right to invoice Buyer for importation costs of repair/replacement parts when product purchased in one country is submitted for repair in another country.

Fluke's warranty obligation is limited, at Fluke's option, to refund of the purchase price, free of charge repair, or replacement of a defective product which is returned to a Fluke authorized service center within the warranty period.

To obtain warranty service, contact your nearest Fluke authorized service center to obtain return authorization information, then send the product to that service center, with a description of the difficulty, postage and insurance prepaid (FOB Destination). Fluke assumes no risk for damage in transit. Following warranty repair, the product will be returned to Buyer, transportation prepaid (FOB Destination). If Fluke determines that failure was caused by neglect, misuse, contamination, alteration, accident, or abnormal condition of operation or handling, including overvoltage failures caused by use outside the product's specified rating, or normal wear and tear of mechanical components, Fluke will provide an estimate of repair costs and obtain authorization before commencing the work. Following repair, the product will be returned to the Buyer transportation prepaid and the Buyer will be billed for the repair and return transportation charges (FOB Shipping Point).

THIS WARRANTY IS BUYER'S SOLE AND EXCLUSIVE REMEDY AND IS IN LIEU OF ALL OTHER WARRANTIES, EXPRESS OR IMPLIED, INCLUDING BUT NOT LIMITED TO ANY IMPLIED WARRANTY OF MERCHANTABILITY OR FITNESS FOR A PARTICULAR PURPOSE. FLUKE SHALL NOT BE LIABLE FOR ANY SPECIAL, INDIRECT, INCIDENTAL, OR CONSEQUENTIAL DAMAGES OR LOSSES, INCLUDING LOSS OF DATA, ARISING FROM ANY CAUSE OR THEORY.

Since some countries or states do not allow limitation of the term of an implied warranty, or exclusion or limitation of incidental or consequential damages, the limitations and exclusions of this warranty may not apply to every buyer. If any provision of this Warranty is held invalid or unenforceable by a court or other decision-maker of competent jurisdiction, such holding will not affect the validity or enforceability of any other provision.

Fluke Corporation
P.O. Box 9090
Everett, WA 98206-9090
U.S.A.

Fluke Europe B.V.
P.O. Box 1186
5602 BD Eindhoven
The Netherlands

11/99

To register your product online, visit register.fluke.com

Table of Contents

Title	Page
Introduction.....	1
Manual Set.....	2
Contacting Fluke.....	2
Safety Information.....	2
General Safety Summary.....	2
Symbols.....	4
Unpacking and Inspecting the Meter.....	4
Storing and Shipping the Meter.....	4
Power Considerations.....	5
Selecting the Line Voltage.....	5
Replacing the Fuses.....	5
Line-Power Fuse.....	5
Current-Input Fuses.....	6
Connecting to Line Power.....	8
Turning Power On.....	9
Adjusting the Bail.....	9
Installing the Meter into an Equipment Rack.....	9
Preparing the Meter for Operations via the RS-232 Interface.....	10
Setting Communication Parameters (RS-232).....	10
Options and Accessories.....	11
Cleaning the Meter.....	12

List of Tables

Table	Title	Page
1.	Safety Information	3
2.	Safety and Electrical Symbols.....	4
3.	Line Voltage to Fuse Rating.....	6
4.	Line-Power Cord Types Available from Fluke.....	8
5.	Factory Settings of RS-232 Communication Parameters.....	11
6.	Accessories.....	11

List of Figures

Figure	Title	Page
1.	Replacing the Line-Power Fuse	6
2.	Replacing the Current-Input Fuses.....	7
3.	Line-Power Cord Types Available from Fluke.....	8
4.	Bail Adjustment and Removal	9
5.	Boot removal.....	10

Digital Multimeter

Introduction

The Fluke 8808A Digital Multimeter (hereafter referred to as the Meter) is a 5-1/2 digit dual-display multimeter designed for bench-top, field service, and system applications. The multiple measurement functions, plus the RS-232 remote interface, make the Meter an ideal candidate for precision manual measurements and use in automated systems. For portability, the Meter includes a carrying handle that also serves as a bail for bench-top operation.

Some features provided by the Meter are:

- A dual vacuum fluorescent display that allows two properties of an input signal to be displayed at the same time (e.g., ac voltage in one display and frequency in the other)
- 5-1/2 digit resolution
- True-rms ac
- 2, 4 wire resistance or patented 2x4 wire resistance measurement technique
- 200 mV to 1000 Vdc range with 1 μ V sensitivity
- 200 mV to 750 Vac rms with 1 μ V sensitivity
- 200 Ω to 100 M Ω with 1 m Ω sensitivity
- 200 μ A to 10 Adc with 1 nA sensitivity
- 20 mA to 10 Aac with 100 nA sensitivity
- Frequency measurements from 20 Hz to 1 MHz
- Continuity and diode test
- Measurement rates of 2.5, 20 and 100 samples/second (slow, medium and fast, respectively)
- Front-panel setup key for single key access to saved setups
- A compare mode to determine if a measurement is within predefined limits.
- Remote operation via the RS-232 interface
- Closed-case calibration (no internal calibration adjustments)

Manual Set

The manual set for this Meter consists of a printed *Getting Started Manual* and a *Users Manual* on a CD-ROM.

This manual contains basic getting started information, contacting Fluke, unpacking, and general specifications. This manual also provides setup and operation information for the Meter, descriptions of the Meter's front and rear-panel features, and information about setting up and powering up the Meter. Please read this information before operating the Meter.

The *Users Manual* contains information on specifications, setup and operating from the front panel. In addition, it contains information on using the Meter remotely from a PC or instrument controller.

Contacting Fluke

To order accessories, receive operating assistance, or get the location of the nearest Fluke distributor or Service Center, call:

USA:	1-888-99-FLUKE (1-888-993-5853)
Canada:	1-800-36-FLUKE (1-800-363-5853)
Europe:	+31 402-675-200
Japan:	+81-3-3434-0181
Singapore:	+65-738-5655
Anywhere in the world:	+1-425-446-5500

Or visit Fluke's Web site at www.fluke.com.

To register this product, visit register.fluke.com.

Safety Information

This section addresses safety considerations and describes symbols that may appear on the Meter or in the manual.

A **Warning** statement identifies conditions or practices that could result in injury or death. A **Caution** statement identifies conditions or practices that could result in damage to the Meter or equipment to which it is connected.

Warning

To avoid electric shock, personal injury, or death, carefully read the information in Table 1, "Safety Information," before attempting to install, use, or service the Meter.

General Safety Summary

This instrument has been designed and tested in accordance with the European standard publication EN61010-1: 2001 and U.S. / Canadian standard publications UL 61010-1:2004 and CAN/CSA-C22.2 No.61010.1:2004. The Meter has been supplied in a safe condition.

This manual contains information and warnings that must be observed to keep the Meter in a safe condition and ensure safe operation.

To use the Meter correctly and safely, read and follow the precautions in Table 1 and follow all the safety instructions or warnings given throughout this manual that relate to specific measurement functions. In addition, follow all generally accepted safety practices and procedures required when working with and around electricity.

Table 1. Safety Information

⚠ ⚠ Warning

















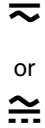

To avoid possible electric shock, personal injury, or death, read the following before using the Meter:

- Use the Meter only as specified in this manual, or the protection provided by the Meter might be impaired.
- Do not use the Meter in wet environments.
- Inspect the Meter before using it. Do not use the Meter if it appears damaged.
- Inspect the test leads before use. Do not use them if insulation is damaged or metal is exposed. Check the test leads for continuity. Replace damaged test leads before using the meter.
- Verify the Meter's operation by measuring a known voltage before and after using it. Do not use the Meter if it operates abnormally. Protection may be impaired. If in doubt, have the Meter serviced.
- Whenever it is likely that safety protection has been impaired, make the Meter inoperative and secure it against any unintended operation.
- Have the Meter serviced only by qualified service personnel.
- Do not apply more than the rated voltage, as marked on the Meter, between the terminals or between any terminal and earth ground.
- Always use the power cord and connector appropriate for the voltage and outlet of the country or location in which you are working.
- Remove test leads from the Meter before opening the case.
- Never remove the cover or open the case of the Meter without first removing it from the main power source.
- Never operate the Meter with the cover removed or the case open.
- Use caution when working with voltages above 30 V ac rms, 42 V ac peak, or 42 V dc. These voltages pose a shock hazard.
- Use only the replacement fuses specified by the manual.
- Use the proper terminals, function and range for your measurements.
- Do not operate the Meter around explosive gas, vapor or dust.
- When using probes, keep your fingers behind the finger guards.
- When making electrical connections, connect the common test lead before connecting the live test lead. When disconnecting, disconnect the live test lead before disconnecting the common test lead.
- Disconnect circuit power and discharge all high voltage capacitors before testing resistance, continuity, diodes, or capacitance.
- Before measuring current, check the Meter's fuses and turn OFF power to the circuit before connecting the Meter to the circuit.
- When servicing the Meter, use only specified replacement parts.

Symbols

Table 2 lists safety and electrical symbols that appear on the Meter or in this manual.

Table 2. Safety and Electrical Symbols

Symbol	Description	Symbol	Description
	Risk of danger. Important information. See manual.		Standby power ON / OFF
	Hazardous voltage. Voltage > 30 V dc or ac peak might be present.		Earth ground
	AC (Alternating Current)		Capacitance
	DC (Direct Current)		Diode
	AC or DC (Alternating or Direct Current)		Fuse
	Continuity test or continuity beeper tone		Digital signal
	Potentially hazardous voltage		Maintenance or Service
	Double insulated		Recycle
	Static awareness. Static discharge can damage parts.		Do not dispose of this product as unsorted municipal waste. Contact Fluke or a qualified recycler for disposal.
CAT II	Measurement Category II is for measurements performed on circuits directly connected to the low voltage installation.	CAT I	Measurement Category I is for measurements not directly connected to mains.

Unpacking and Inspecting the Meter

Every care is taken in the choice of packing material to ensure that your Meter will reach you in perfect condition. If the Meter has been subject to excessive handling in transit, there may be visible external damage to the shipping carton. In the event of damage, keep the shipping container and packing material for the carrier's inspection.

Carefully unpack the Meter from its shipping container and inspect the contents for damaged or missing items. If the Meter appears damaged or something is missing, contact the carrier and Fluke immediately. Save the container and packing material in case you have to return the Meter.

Storing and Shipping the Meter

To prepare the Meter for storage or shipping, use the original shipping container if possible, as it provides shock isolation for normal handling operations. If the original shipping container is not available, use a box that is 17.5 x 15.5 x 8.0 inches, with cushioning material that fills the space between the Meter and the sides of the box.

To store the Meter, place the box under cover in a location that complies with the storage environment specifications described in the “General Specifications” section later in this manual.

Power Considerations

The Meter operates on varying power distribution standards found throughout the world and must be set up to operate on the line voltage that will power it. The Meter is packed ready for use with a line voltage determined at the time of ordering. If the selected line voltage does not match the power that the Meter will be plugged into, the Meter’s line-voltage setting must be changed and replacement of the line fuse may be required.

Selecting the Line Voltage

The Meter operates on four different input line voltages. The selected line-voltage setting is visible through the window in the line-fuse holder on the Meter’s rear panel.

1. Unplug the power cord.
2. Insert a small screwdriver blade into the narrow recess to the left of the fuse holder and pry it to the right until the holder pops out. See Figure 1.
3. Remove the voltage-selector block from the fuse holder.
4. Rotate the selector block until the desired voltage rating faces outward.
5. Replace the selector block back into the fuse holder.
6. Install the fuse holder back into the Meter and reconnect the power cord.

Changing the line-voltage setting may require a different line-power fuse for proper operation.

Replacing the Fuses

The Meter uses one fuse to protect the line-power input and two fuses to protect current-measurement inputs.

Line-Power Fuse

The Meter has a line-power fuse in series with the power supply. Table 3 indicates the proper fuse for each of the four line-voltage selections. The line-power fuse is accessed through the rear panel.

1. Unplug the power cord.
2. Insert a small screwdriver blade into the narrow recess to the left of the fuse holder and pry it to the right until the holder pops out. See Figure 1.
3. Remove the fuse and replace it with a fuse of an appropriate rating for the selected line-power voltage. See Table 3.
4. Replace the selector block back into the fuse holder.

Warning

To avoid electric shock or fire, do not use makeshift fuses or short-circuit the fuse holder.

Table 3. Line Voltage to Fuse Rating

Line Voltage Selection	Fuse Rating
100 / 120	0.125 A, 250 V (slow blow)
220 / 240	0.063 A, 250 V (slow blow)

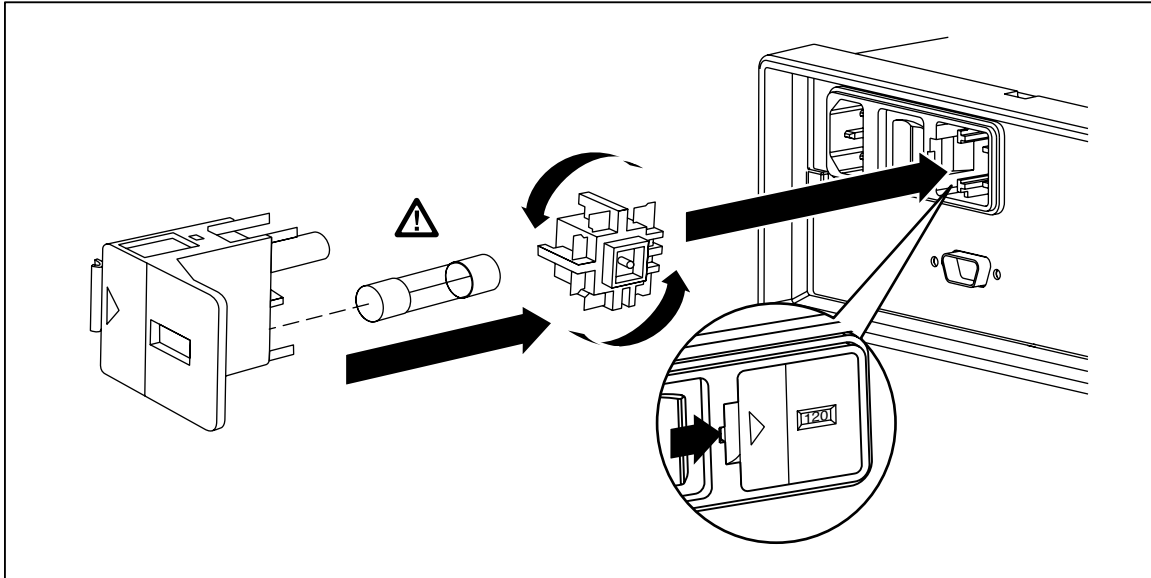

Figure 1. Replacing the Line-Power Fuse

Current-Input Fuses

The **200 mA** and **10 A** inputs are protected by user-replaceable fuses.

- The **200 mA** input is protected by a fuse rated at 440 mA, 1000 V (fast blow), 10,000 A minimum breaking capacity.
- The **10 A** input is protected by a fuse rated at 11 A, 1000 V (fast blow), 10,000 A minimum breaking capacity.

⚠ ⚠ Warning

For protection against fire or arc flash, replace a blown fuse with a fuse of an identical rating.

To test the current-input fuses:

1. Turn on the Meter and plug a test lead into the **INPUT VΩ → HI** terminal.
2. Press **Ω**.
3. Press **▼** to set the range to 200 Ω. Only the 200 Ω, 2 kΩ, and 20 kΩ ranges can be used to test the mA input fuse.
4. Insert the other end of the test lead into the **mA** terminal. If the fuse is good, the Meter displays a reading of 0.000 MΩ. If the fuse is blown, the Meter displays **OL** to indicate an overload.
5. Remove the test lead from the **mA** terminal and insert it into the **10 A** terminal. If the fuse is good, the Meter displays a reading of <1.000 Ω. If the fuse is blown, the Meter displays **OL** to indicate an overload.

⚠ ⚠ Warning

To avoid electric shock, remove the power cord and any test leads from the Meter before opening the current-input fuse access door.

To replace the current-input fuses:

1. Unplug the power cord.
2. Turn the Meter upside down.
3. Remove the retaining screw on the fuse access door. See Figure 2.
4. Remove the protective cover from the fuse holders by slightly depressing the back edge of the cover to unlatch it from the printed circuit board. Pull up on the back edge of the cover and remove it from the fuse compartment.
5. Remove the defective fuse and replace it with a fuse of an appropriate rating. See Table 3.
6. Replace the protective cover by pushing it over the fuses while aligning the catches with the holes in the printed circuit board. Press the cover down until the catches engage the printed circuit board.
7. Replace the fuse access door and install the retaining screw.

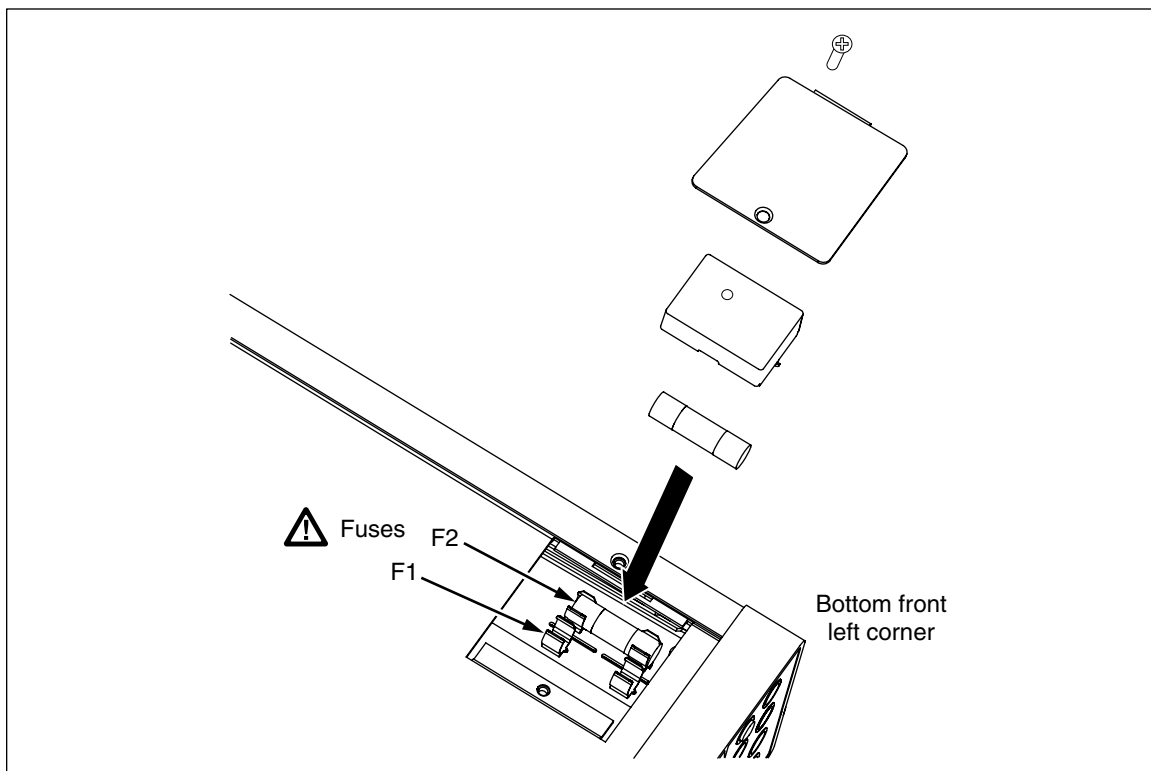

caw20.eps

Figure 2. Replacing the Current-Input Fuses

Connecting to Line Power

⚠⚠ Warning

To avoid shock hazard, connect the factory supplied three-conductor line power cord to a properly grounded power outlet. Do not use a two-conductor adapter or extension cord, as this will break the protective ground connection. If a two-conductor power cord must be used, a protective grounding wire must be connected between the ground terminal and earth ground before connecting the power cord or operating the Meter.

1. Verify that the line voltage is set to the correct setting.
2. Verify that the correct fuse for the line voltage is installed.
3. Connect the power cord to a properly grounded three-prong outlet. See Figure 3 for line-power cord types available from Fluke. Refer to Table 4 for descriptions of the line-power cords.

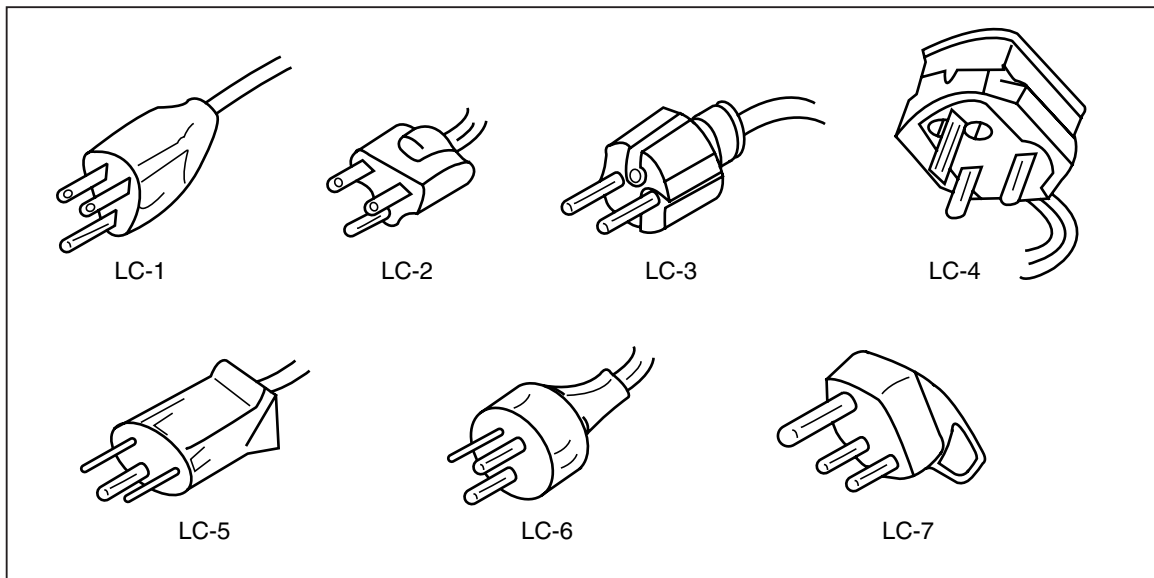

Figure 3. Line-Power Cord Types Available from Fluke

alh3.eps

Table 4. Line-Power Cord Types Available from Fluke

Type	Voltage / Current	Fluke Model Number
North America	120 V / 15 A	LC-1
North America	240 V / 15 A	LC-2
Universal Euro	220 V / 16 A	LC-3
United Kingdom	240 V / 13 A	LC-4
Switzerland	220 V / 10 A	LC-5
Australia	240 V / 10 A	LC-6
South Africa	240 V / 5 A	LC-7

Turning Power On

1. If required, connect the Meter to line power.
2. Toggle the power switch on the rear panel so the “I” side of the switch is depressed. The Meter will turn on and briefly illuminate all LCD segments.

Note

To save on power consumption, the Meter can be set to a standby mode by pressing  on the front panel. Press it again to bring the Meter up to full power.

Adjusting the Bail

The bail (handle) is adjustable to provide two viewing angles. The bail is also adjustable for carrying or storing the Meter.

To adjust the bail, pull the ends out to a hard stop (about 1/4-inch on each side) and then rotate it to one of the four stop positions as shown in Figure 4.

To remove the bail, adjust it to the vertical stop position and pull the ends all the way out.

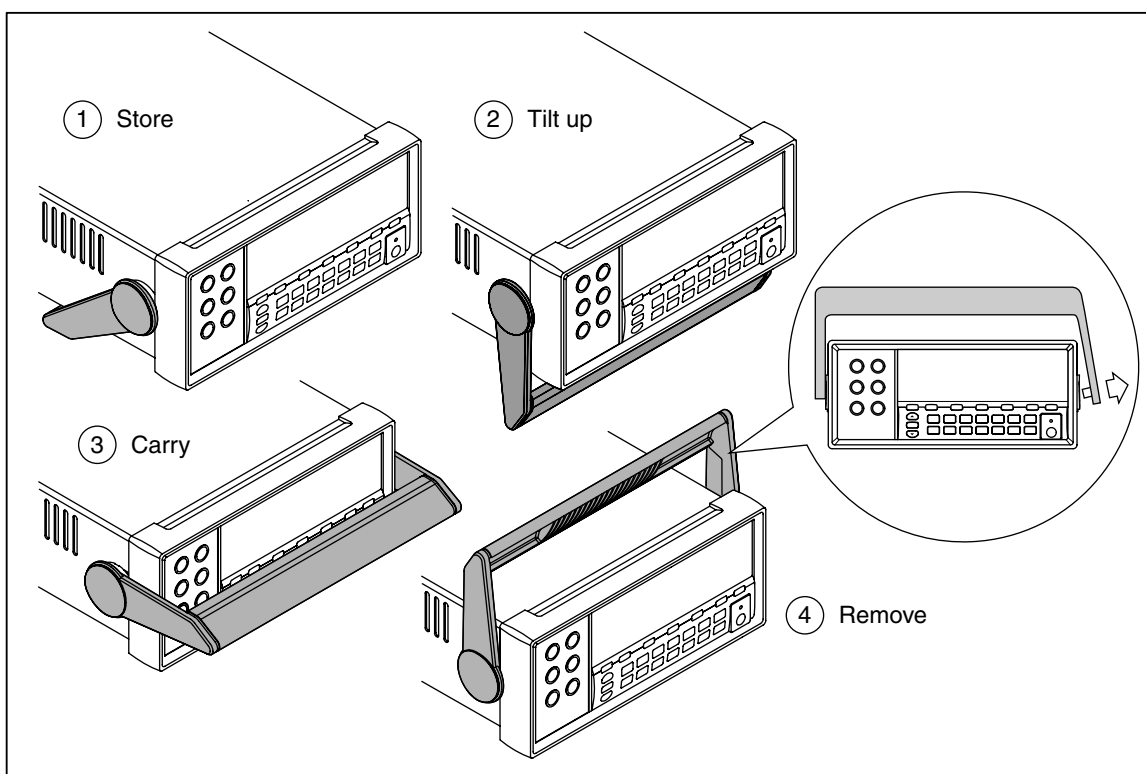

Figure 4. Bail Adjustment and Removal

eue21.eps

Installing the Meter into an Equipment Rack

The Meter is mountable in a standard 19-inch rack using a rack mount kit. See the “Options and Accessories” section later in this manual for ordering information.

To prepare the Meter for rack mounting, remove the bail and remove the front and rear protective boots. To remove a boot, stretch a corner then slide it off as shown in Figure 5.

To install the Meter into the rack, refer to the instructions provided with the Rack Mount Kit.

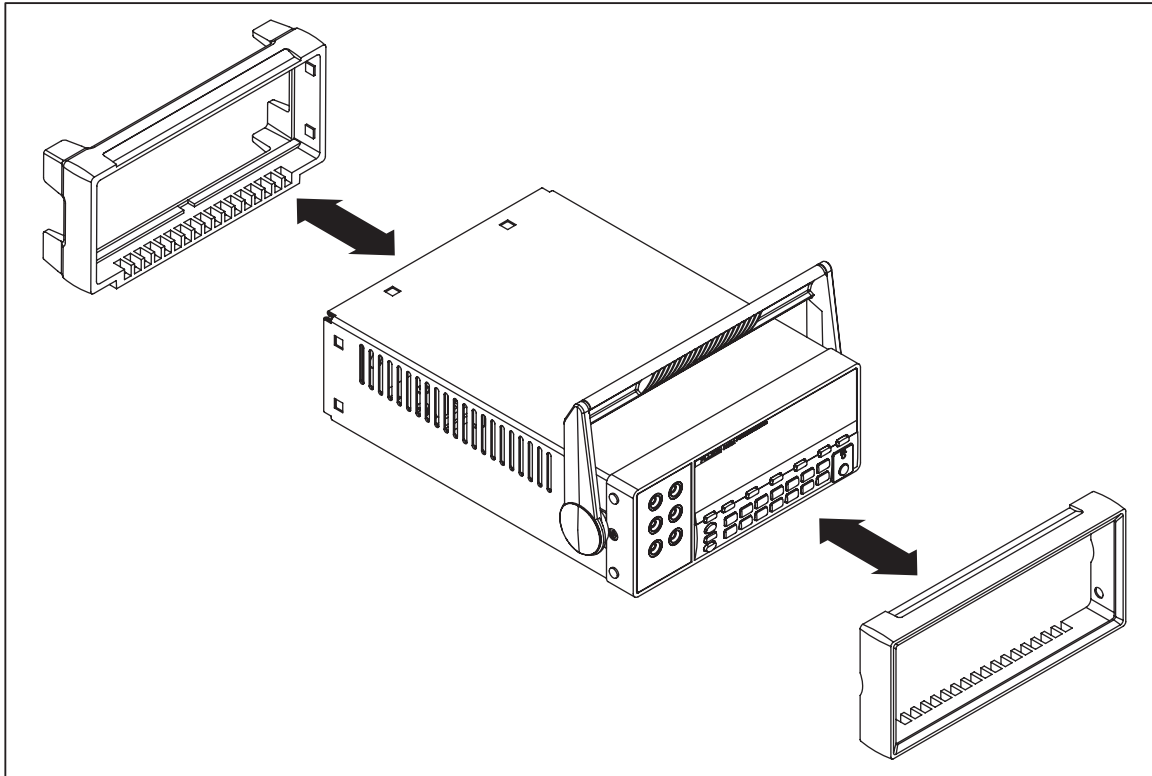

eue22.eps

Figure 5. Boot removal







Preparing the Meter for Operations via the RS-232 Interface

The RS-232 interface allows ASCII asynchronous serial communication between the Meter and a host, serial printer, or terminal. The following section describes setting up the RS-232 port. Additional information on how to communicate and control the Meter through the RS-232 port is contained in Chapter 5 of the *8808A Users Manual* on the accompanying CD.

Setting Communication Parameters (RS-232)

Table 5 provides the RS-232 parameters factory settings. Setting RS-232 communication parameters can only be performed from the front panel.

In order for the Meter and host to communicate via the RS-232 interface, the communication parameters of the Meter must match those of the host. If the communications parameters of the host and Meter do not match, set the appropriate baud rate and parity parameters as follows:

1. Press  to turn the Meter on.
2. Press  and . The baud rate currently selected is shown in the primary display and **baud** is shown in the secondary display.
3. Press  or  to scroll to the desired baud rate, and then press  for 2 seconds to set the RS-232 baud rate.









4. Press  or  to scroll to desired data bits (7 or 8) selection, then press  for 2 seconds to set parity. **Echo** appears on the secondary display, and **On** or **OFF** appears on the primary display.
5. To select an Echo mode, press  or  to select **On** or **OFF**, and then press  for 2 seconds to set the selected Echo state. When Echo is on, each command sent to the Meter over the RS-232 interface is echoed to the host's display screen. When Echo is off, commands are not echoed.
6. Press  to review the settings. When you are ready to accept the settings, press and hold  for 2 seconds.

Table 5. Factory Settings of RS-232 Communication Parameters

Parameter	Factory Setting
Interface	RS-232 (Print-only rate set to 0)
Baud rate	9600
Parity	None (parity bit 0)
Number of data bits	8 (7 data bits plus 1 parity bit)
Number of stop bits	1
Echo	On

Options and Accessories

Table 6 lists available options and accessories.

Table 6. Accessories

Item	Model / Part Number
Premium Test Lead Set	TL71
Fuse, .25*1.25, 0.063 A, 250 V, Slow	163030
Fuse, .25*1.25, 0.125 A, 250 V, Slow	166488
F1 - Fuse, 11 A, 1000 V, Fast, 406INX1.5IN, BULK	803293
F2 - Fuse, 440 mA, 1000 V, Fast, 406INX1.375IN, BULK	943121
Rack Mount Kit 8845A & 8846A Single	Y8846S
Rack Mount Kit 8845A & 8846A Dual	Y8846D
RS-232 Cable (2 m)	RS43
Precision Electronic Prob Set	TL910
2X4 Wire Ohms 1000 V Test Lead	TL2X4W-PTII
FlukeView Forms Basic Software	FVF-SC5
FlukeView Forms Software Upgrade to enhanced version	FVF-UG

Cleaning the Meter

Warning

To avoid electric shock or damage to the Meter, never get water inside the Meter.

Caution

To avoid damaging the Meter's housing, do not apply solvents to the Meter.

If the Meter requires cleaning, wipe it down with a cloth that is lightly dampened with water or a mild detergent. Do not use aromatic hydrocarbons, alcohol, chlorinated solvents, or methanol-based fluids when wiping down the Meter.

FLUKE®

8808A

Digital Multimeter

Specifications

PN 2716412

July 2007

© 2007 Fluke Corporation, All rights reserved. Printed in China
All product names are trademarks of their respective companies.

Table of Contents

Title	Page
General Specifications	1
Voltage	1
Dimensions	1
Display	1
Environment	1
Safety	2
EMC	2
Triggering	2
Math Functions	2
Electrical	2
Remote Interfaces	2
Warranty	2
Electrical Specifications	2
DC Voltage Specifications	2
AC Voltage Specifications	3
Resistance	4
DC Current	5
AC Current	5
Frequency	6
Continuity	6
Diode Test	7

Specifications

General Specifications

Voltage

100V Setting	90 V to 110 V
120V Setting	108 V to 132 V
220V Setting	198 V to 242 V
240V Setting	216 V to 264 V
Frequency	47 Hz to 440 Hz.
Power Consumption	15 VA peak (10 W average)

Dimensions

Height	88 mm (3.46 in)
Width	217 mm (8.56 in)
Depth	297 mm (11.7 in)
Weight	2.1 kg (4.6 lbs)

Display

Vacuum Fluorescent Display, segment

Environment

Temperature

Operating	0 °C to 50 °C
Storage	-40 °C to 70 °C
Warm Up	½ hour to full uncertainty specifications

Relative Humidity (non-condensing)

Operating	Uncontrolled (< 10°C)
	<90 % (10 °C to 30 °C)
	<75 % (30 °C to 40 °C)
	<45 % (40 °C to 50 °C)
Storage	-40 °C to 70 °C <95 %

Altitude

Operating

Operating	2,000 Meters
-----------------	--------------

Storage

Storage	12,000 Meters
---------------	---------------

Vibration

Vibration	Complies with MIL-PRF-28800F Class 3
-----------------	--------------------------------------

Safety

Complies with IEC 61010-1:2001, ANSI/ISA 61010-1 (S82.02.01):2004, UL 61010-1:2004, CAN/CSA C22.2 No. 61010.1:2004, CAT I 1000V/CAT II 600 V.

EMC

Designed to comply with IEC 61326-1:1997+A1:1998+A2:2000

Triggering

Trigger Delay	400 ms
External Trigger Delay	<2 ms
External Trigger Jitter	<1 ms
Trigger Input	TTL Levels
Trigger Output	5 V max

Math Functions

Min/max, relative, hold, compare and dB functions.

Electrical

Input Protection	1000 V all ranges
Overrange	10 % on the largest ranges of all functions except continuity and diode test

Remote Interfaces

RS-232C

Warranty

One year

Electrical Specifications

Accuracy specifications are valid for 5-½ digit mode and after at least a half-hour warm-up.

DC Voltage Specifications

Maximum Input	1000 V on any range.
Common Mode Rejection	120 dB at 50 or 60 Hz \pm 0.1% (1 k Ω unbalance)
Normal Mode Rejection	80 dB at Slow Rate
A/D Nonlinearity	15 ppm of range
Input Bias Current	<30 pA at 25 °C
Settling Considerations	Measurement settling times are affected by source impedance, cable dielectric characteristics, and input signal changes

Input Characteristics

Range	Full-Scale (5-1/2 Digits)	Resolution			Input Impedance
		Slow	Medium	Fast	
200 mV	199.999 mV	1 μ V	10 μ V	10 μ V	>10 G Ω ^[1]
2 V	1.99999 V	10 μ V	100 μ V	100 μ V	>10 G Ω ^[1]
20 V	19.9999 V	100 μ V	1000 μ V	1000 μ V	10 M Ω \pm 1 %
200 V	199.999 V	1 mV	10 mV	10 mV	10 M Ω \pm 1 %
1000 V	1000.00 V	10 mV	100 mV	100 mV	10 M Ω \pm 1 %
Notes:					
[1] At some dual display measurements, the input impedance of 200 mV and 2 V ranges may be changed to 10 M Ω .					

Accuracy

Range	Accuracy ^[1]		Temperature Coefficient/°C Outside 18 – 28 °C
	90 days	1 year	
	23 °C ± 5 °C	23 °C ± 5 °C	
200 mV	0.01 + 0.003	0.015 + 0.004	0.0015 + 0.0005
2 V	0.01 + 0.002	0.015 + 0.003	0.001 + 0.0005
20 V	0.01 + 0.003	0.015 + 0.004	0.0020 + 0.0005
200 V	0.01 + 0.002	0.015 + 0.003	0.0015 + 0.0005
1000 V	0.01 + 0.002	0.015 + 0.003	0.0015 + 0.0005

Notes:
[1] Accuracy given as ± (% of reading + % of range)

AC Voltage Specifications

AC Voltage specifications are for ac sinewave signals >5 % of range. For inputs from 1 % to 5 % of range and <50 kHz, add an additional error of 0.1 % of range, and for 50kHz to 100 kHz, add 0.13 % of range.

- Maximum Input** 750 V rms or 1000 V peak or 8×10^7 Volts-Hertz product
- Measurement Method** AC-coupled true-rms. Measures the ac component of input with up to 1000 V dc bias on any range.
- AC Filter Bandwidth:**
 - Slow 20 Hz – 100 kHz
- Common Mode Rejection** 60 dB at 50 Hz or 60 Hz (1 kΩ unbalance)
- Maximum Crest Factor** 3:1 at Full Scale
- Additional Crest Factor Errors (<100 Hz)** Crest Factor 1-2, 0.05 % of full scale
Crest Factor 2-3, 0.2 % of full scale

Input Characteristics

Range	Full-Scale (5-1/2 Digits)	Resolution			Input Impedance
		Slow	Medium	Fast	
200 mV	199.999 mV	1 µV	10 µV	10 µV	1 MΩ ±2 % shunted by <100 pf
2 V	1.99999 V	10 µV	100 µV	100 µV	
20 V	19.9999 V	100 µV	1000 µV	1000 µV	
200 V	199.999 V	1 mV	10 mV	10 mV	
750 V	750.00 V	10 mV	100 mV	100 mV	

Accuracy

Range	Frequency	Accuracy ^[1]		Temperature Coefficient/°C Outside 18 – 28 °C
		90 days	1 year	
		23 °C ± 5 °C	23 °C ± 5 °C	
200 mV	20 Hz – 45Hz	0.8 + 0.05	0.9 + 0.05	0.01 + 0.005
	45 Hz – 20 kHz	0.15 + 0.05	0.2 + 0.05	0.01 + 0.005
	20 kHz – 50 kHz	0.3 + 0.05	0.35 + 0.05	0.01 + 0.005
	50 kHz – 100 kHz	0.8 + 0.05	0.9 + 0.05	0.05 + 0.01
2 V	20 Hz – 45Hz	0.8 + 0.05	0.9 + 0.05	0.01 + 0.005
	45 Hz – 20 kHz	0.15 + 0.05	0.2 + 0.05	0.01 + 0.005
	20 kHz – 50 kHz	0.3 + 0.05	0.35 + 0.05	0.01 + 0.005
	50 kHz – 100 kHz	0.8 + 0.05	0.9 + 0.05	0.05 + 0.01
20 V	20 Hz – 45 Hz	0.8 + 0.05	0.9 + 0.05	0.01 + 0.005
	45 Hz – 20 kHz	0.15 + 0.05	0.2 + 0.05	0.01 + 0.005
	20 kHz – 50 kHz	0.3 + 0.05	0.35 + 0.05	0.01 + 0.005
	50 kHz – 100 kHz	0.8 + 0.05	0.9 + 0.05	0.05 + 0.01

Accuracy (cont.)

Range	Frequency	Accuracy ^[1]		Temperature Coefficient/°C Outside 18 – 28 °C
		90 days	1 year	
		23 °C ± 5 °C	23 °C ± 5 °C	
200 V	20 Hz – 45Hz	0.8 + 0.05	0.9 + 0.05	0.01 + 0.005
	45 Hz – 20 kHz	0.15 + 0.05	0.2 + 0.05	0.01 + 0.005
	20 kHz – 50 kHz	0.3 + 0.05	0.35 + 0.05	0.01 + 0.005
	50 kHz – 100 kHz	0.8 + 0.05	0.9 + 0.05	0.05 + 0.01
750 V	20 Hz – 45Hz	0.8 + 0.05	0.9 + 0.05	0.01 + 0.005
	45 Hz – 20 kHz	0.15 + 0.05	0.2 + 0.05	0.01 + 0.005
	20 kHz – 50 kHz	0.3 + 0.05	0.35 + 0.05	0.01 + 0.005
	50 kHz – 100 kHz	0.8 + 0.05	0.9 + 0.05	0.05 + 0.01

Notes:
[1] Accuracy given as ± (% of reading + % of range)

Resistance

Specifications are for 4-wire resistance function, or 2-wire resistance with REL. If REL is not used, add 0.2 Ω for 2-wire resistance plus lead resistance.

Measurement Method Current source referenced to LO input

Max Lead Resistance (4-wire ohms) 10 % of range per lead for 200 Ω, 2 kΩ ranges. 1 kΩ per lead on all other ranges.

Input Protection 1000 V on all ranges

Input Characteristics

Range	Full-Scale (5-1/2 Digits)	Resolution			Current Source
		Slow	Medium	Fast	
200 Ω	199.999 Ω	0.001 Ω	0.01 Ω	0.01 Ω	0.8 mA
2 kΩ	1.99999 kΩ	0.01 Ω	0.1 Ω	0.1 Ω	0.8 mA
20 kΩ	19.9999 kΩ	0.1 Ω	1 Ω	1 Ω	0.08 mA
200 kΩ	199.999 kΩ	1 Ω	10 Ω	10 Ω	0.008 mA
2 MΩ	1.99999 MΩ	10 Ω	100 Ω	100 Ω	0.9 μA
20 MΩ	19.9999 MΩ	100 Ω	1 kΩ	1 kΩ	0.16 μA
100 MΩ	100.000 MΩ	1 kΩ	10 kΩ	10 kΩ	0.16 μA 10 MΩ

Accuracy

Range	Accuracy ^[1]		Temperature Coefficient/°C Outside 18 – 28 °C
	90 days	1 year	
	23 °C ± 5 °C	23 °C ± 5 °C	
200 Ω	0.02 + 0.004	0.03 + 0.004	0.003 + 0.0006
2 kΩ	0.015 + 0.002	0.02 + 0.003	0.003 + 0.0005
20 kΩ	0.015 + 0.002	0.02 + 0.003	0.003 + 0.0005
200 kΩ	0.015 + 0.002	0.02 + 0.003	0.003 + 0.0005
2 MΩ	0.03 + 0.003	0.04 + 0.004	0.004 + 0.0005
20 MΩ	0.2 + 0.003	0.25 + 0.003	0.01 + 0.0005
100 MΩ	1.5 + 0.004	1.75 + 0.004	0.2 + 0.0005

Notes:
[1] Accuracy given as ± (% of reading + % of range)

DC Current

Input Protection Tool accessible 11 A / 1000 V and 440 mA / 1000 V fuses.
Shunt Resistance 0.01 Ω for 2 A and 10 A ranges
 1 Ω for 20 mA and 200 mA
 Burden voltage < 1 mV for 200 uA and 2 mA range.

Input Characteristics

Range	Full-Scale (5-1/2 Digits)	Resolution			Burden Voltage
		Slow	Medium	Fast	
200 uA	199.999 μA	0.001 μA	0.01 μA	0.01 μA	<1 mV
2 mA	1999.99 μA	0.01 μA	0.1 μA	0.1 μA	<1 mV
20 mA	19.9999 mA	0.1 μA	1 μA	1 μA	<0.05 V
200 mA	199.999 mA	1 μA	10 μA	10 μA	<0.5 V
2 A	1.99999 A	10 μA	100 μA	100 μA	<0.1 V
10 A	10.0000 A	100 μA	1 mA	1 mA	<0.5 V

Accuracy

Range	Accuracy ^[1]		Temperature Coefficient/°C Outside 18 – 28 °C
	90 days	1 year	
	23 °C ± 5 °C	23 °C ± 5 °C	
200 μA	0.02 + 0.005	0.03 + 0.005	0.003 + 0.001
2 mA	0.015 + 0.005	0.02 + 0.005	0.002 + 0.001
20 mA	0.03 + 0.02	0.04 + 0.02	0.005 + 0.001
200 mA	0.02 + 0.005	0.03 + 0.008	0.005 + 0.001
2 A	0.05 + 0.02	0.08 + 0.02	0.008 + 0.001
10 A	0.18 + 0.01	0.2 + 0.01	0.008 + 0.001

Notes:
 [1] Accuracy given as ± (% of reading + % of range)

AC Current

The following ac current specifications are for sinusoidal signals with amplitudes greater than 5 % of range. For inputs from 1 % to 5 % of range, add an additional error of 0.1 % of range.

Input Protection Tool accessible 11 A / 1000 V and 440 mA / 1000 V fuses
Measurement Method AC-coupled True RMS
Shunt Resistance 0.01 Ω for 2 A and 10 A ranges
 1 Ω for 20 mA and 200 mA

AC Filter Bandwidth:

Slow 20 Hz – 100 kHz

Maximum Crest Factor 3:1 at Full Scale

Additional Crest Factor Errors (<100 Hz) Crest Factor 1-2, 0.05 % of full scale
 Crest Factor 2-3, 0.2 % of full scale

Input Characteristics

Range	Full-Scale (5-1/2 Digits)	Resolution			Burden Voltage
		Slow	Medium	Fast	
20 mA	19.9999 mA	0.1 μA	1 μA	1 μA	<0.05 V
200 mA	199.999 mA	1 μA	10 μA	10 μA	<0.5 V
2 A	1.99999 A	10 μA	100 μA	100 μA	<0.1 V
10 A	10.0000 A	100 μA	1 mA	1 mA	<0.5 V

Accuracy

Range	Frequency	Accuracy ^[1]		Temperature Coefficient/°C Outside 18 – 28 °C
		90 days	1 year	
		23 °C ± 5 °C	23 °C ± 5 °C	
20 mA	20 Hz - 45Hz	1 + 0.05	1.25 + 0.06	0.015 + 0.005
	45 Hz - 2 kHz	0.25 + 0.05	0.3 + 0.06	0.015 + 0.005
200 mA	20 Hz - 45Hz	0.8 + 0.05	1 + 0.06	0.015 + 0.005
	45 Hz - 2 kHz	0.25 + 0.05	0.3 + 0.06	0.015 + 0.005
2 A	20 Hz - 45Hz	1 + 0.05	1.25 + 0.06	0.015 + 0.005
	45 Hz - 2 kHz	0.25 + 0.05	0.3 + 0.06	0.015 + 0.005
10 A	20 Hz - 45Hz	1 + 0.1	1.25 + 0.12	0.015 + 0.005
	45 Hz - 2 kHz	0.35 + 0.1	0.5 + 0.12	0.015 + 0.005

Notes:
[1] Accuracy given as ± (% of reading + % of range)

Frequency

Gate Time	131 ms
Measurement Method	AC-coupled input using the ac voltage measurement function.
Settling Considerations	When measuring frequency after a dc offset voltage change, errors may occur. For the most accurate measurement, wait up to 1 second to allow input blocking RC time constant to settle.
Measurement Considerations	To minimize measurement errors, shield inputs from external noise when measuring low voltage, low frequency signals.

Accuracy

Range	Frequency	Accuracy		Temperature Coefficient/°C Outside 18 – 28 °C
		90 days	1 year	
		23 °C ± 5 °C	23 °C ± 5 °C	
100 mV to 750 V ^[1,2]	20 Hz – 2 kHz	0.01 + 0.002	0.01 + 0.003	0.002 + 0.001
	2 kHz – 20 kHz	0.01 + 0.002	0.01 + 0.003	0.002 + 0.001
	20 kHz – 200 kHz	0.01 + 0.002	0.01 + 0.003	0.002 + 0.001
	200 kHz – 1 MHz	0.01 + 0.004	0.01 + 0.006	0.002 + 0.002

Notes:
[1] Input > 100 mV
[2] Limited to 8×10^7 V Hz

Continuity

Continuity Threshold	20 Ω
Test Currents	1 mA
Response Time	100 samples/sec with audible tone
Rate	Fast
Maximum Reading	199.99 Ω
Resolution	0.01 Ω

Diode Test

Response Time	100 samples/sec with audible tone
Rate	Fast
Maximum Reading	1.9999 V
Resolution	0.1 mV