

HOA1397

Reflective Sensor

FEATURES

- Choice of phototransistor or photodarlington output
- Low profile for design flexibility
- Unfocused for sensing diffused surfaces

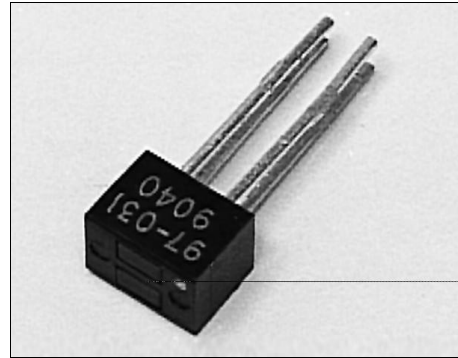

INFRA-10.TIF

DESCRIPTION

The HOA1397 series consists of an infrared emitting diode and an NPN silicon phototransistor (HOA1397-001, -002) or photodarlington (HOA1397-031, 032) encased side-by-side on parallel axes in a miniature black thermoplastic housing. The detector responds to radiation from the IRED only when a reflective object passes within its field of view. The HOA1397 series employs plastic molded components. For additional component information refer to SEP8507 and SDP8407.

Housing material is polyester. Housings are soluble in chlorinated hydrocarbons and ketones. Recommended cleaning agents are methanol and isopropanol.

OUTLINE DIMENSIONS in inches (mm)

Tolerance 3 plc decimals ±0.010(0.25)
2 plc decimals ±0.020(0.51)

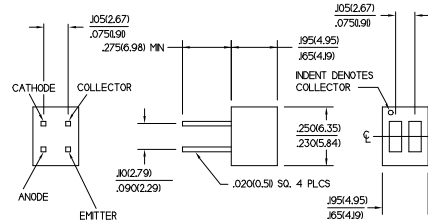

DIM_036.cdr

HOA1397

Reflective Sensor

ELECTRICAL CHARACTERISTICS (25°C unless otherwise noted)

PARAMETER	SYMBOL	MIN	TYP	MAX	UNITS	TEST CONDITIONS
IR EMITTER						
Forward Voltage	V_F			1.6	V	$I_F=20$ mA
Reverse Leakage Current	I_R			10	μ A	$V_R=3$ V
DETECTOR						
Collector-Emitter Breakdown Voltage	$V_{(BR)CEO}$				V	$I_C=100$ μ A
HOA1397-001, -002		30				
HOA1397-031, -032		15				
Emitter-Collector Breakdown Voltage	$V_{(BR)ECO}$	5.0			V	$I_E=100$ μ A
Collector Dark Current	I_{CEO}				nA	$V_{CE}=10$ V $I_F=0$
HOA1397-001, -002				100		
HOA1397-031, -032				250		
COUPLED CHARACTERISTICS						
On-State Collector Current	$I_{C(ON)}$				mA	$V_{CE}=5$ V $I_F=20$ mA (1)
HOA1397-001		0.2				
HOA1397-002		0.7				
HOA1397-031		2.0				
HOA1397-032		7.0				
Collector-Emitter Saturation Voltage	$V_{CE(SAT)}$				V	$I_F=20$ mA (1) $I_C=30$ μ A $I_C=90$ μ A $I_C=250$ μ A $I_C=880$ μ A
HOA1397-001			0.4			
HOA1397-002			0.4			
HOA1397-031			1.1			
HOA1397-032			1.1			
Rise And Fall Time	t_r, t_f				μ s	$V_{CC}=5$ V, $I_C=1$ mA $R_L=1000$ Ω $R_L=100$ Ω
HOA1397-001, -002			15			
HOA1397-031, -032			75			

Notes

1. Test surface is a Eastman Kodak Neutral white test card with 90% diffuse reflectance located 0.05 in. (1.27 mm) from the front surface of the device.

ABSOLUTE MAXIMUM RATINGS

(25°C Free-Air Temperature unless otherwise noted)

Operating Temperature Range -40°C to 85°C
Storage Temperature Range -40°C to 85°C
Soldering Temperature (5 sec) 240°C

IR EMITTER

Power Dissipation 100 mW (1)
Reverse Voltage 3 V
Continuous Forward Current 60 mA

DETECTOR

	TRANS.	DARLINGTON
Collector-Emitter Voltage	30 V	15 V
Emitter-Collector Voltage	5 V	5 V
Power Dissipation	100 mW (1)	100 mW (1)
Collector DC Current	30 mA	30 mA

SCHEMATIC

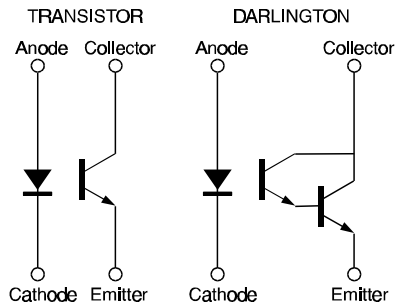

Honeywell reserves the right to make changes in order to improve design and supply the best products possible.

Honeywell

245

HOA1397

Reflective Sensor

Fig. 1 IRED Forward Bias Characteristics

gra_073.ds4

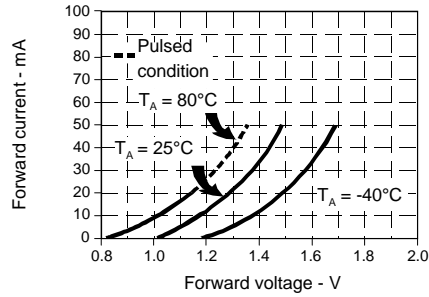

Fig. 2 Non-Saturated Switching Time vs Load Resistance

gra_079.ds4

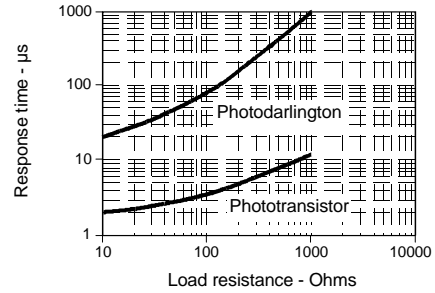

Fig. 3 Dark Current vs Temperature

gra_301.cdr

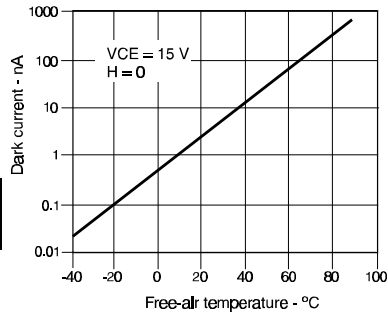

Fig. 4 Collector Current vs Ambient Temperature

gra_076.ds4

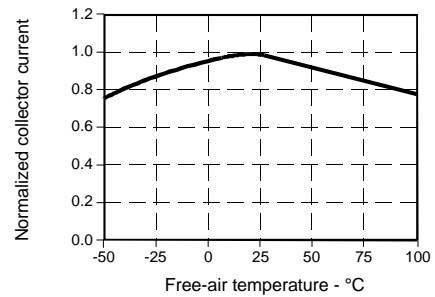

Fig. 5 Collector Current vs Distance to Reflective Surface

gra_086.ds4

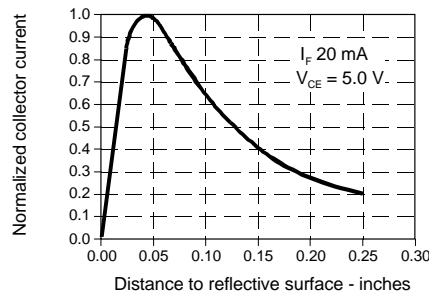
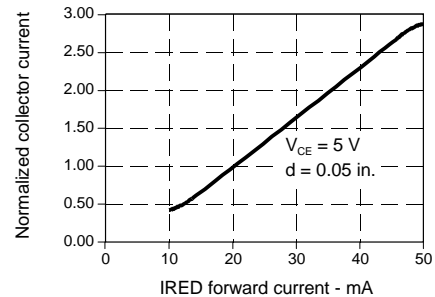

Fig. 6 Collector Current vs IRED Forward Current

gra_087.ds4



All Performance Curves Show Typical Values

HOA1397

Reflective Sensor



Honeywell reserves the right to make changes in order to improve design and supply the best products possible.

Honeywell

247