

HOA1404

Reflective Sensor

FEATURES

- Choice of phototransistor or photodarlington output
- Focused for maximum response
- Wide operating temperature range (-55°C to +100°C)

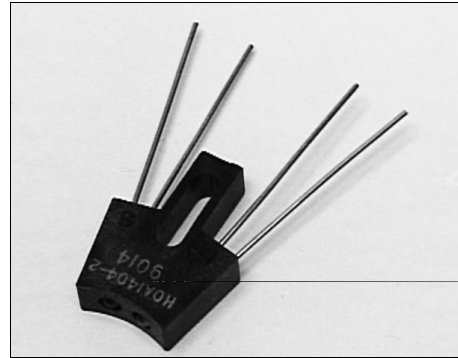

INFRA-61.TIF

DESCRIPTION

The HOA1404 series consists of an infrared emitting diode and an NPN silicon phototransistor (HOA1404-001,-002) or photodarlington (HOA1404-003), encased side-by-side on converging optical axes, in a black thermoplastic housing. The detector responds to radiation from the IRED only when a reflective object passes within its field of view. The HOA1404 series employs metal can packaged components. For additional component information see SE1450, SD1440, and SD1410.

Housing material is acetal copolymer. Housings are soluble in chlorinated hydrocarbons and ketones. Recommended cleaning agents are methanol and isopropanol.

OUTLINE DIMENSIONS in inches (mm)

Tolerance 3 plc decimals ±0.010(0.25)
2 plc decimals ±0.020(0.51)

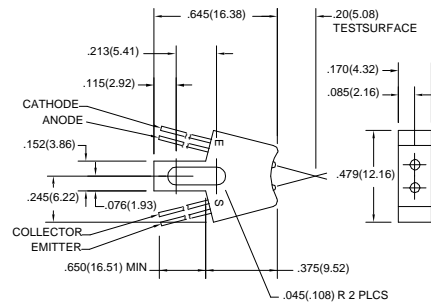

DIM_037.d64

HOA1404

Reflective Sensor

ELECTRICAL CHARACTERISTICS (25°C unless otherwise noted)

PARAMETER	SYMBOL	MIN	TYP	MAX	UNITS	TEST CONDITIONS
IR EMITTER						
Forward Voltage	V_F			1.6	V	$I_F=20$ mA
Reverse Leakage Current	I_R			10	μ A	$V_R=3$ V
DETECTOR						
Collector-Emitter Breakdown Voltage	$V_{(BR)CEO}$				V	$I_C=100$ μ A
HOA1404-001, -002		30				
HOA1404-003		15				
Emitter-Collector Breakdown Voltage	$V_{(BR)ECO}$	5.0			V	$I_E=100$ μ A
Collector Dark Current	I_{CEO}				nA	$V_{CE}=10$ V
HOA1404-001, -002				100		$I_F=0$
HOA1404-003				250		
COUPLED CHARACTERISTICS						
On-State Collector Current	$I_{C(ON)}$				mA	$V_{CE}=5$ V
HOA1404-001		0.2				$I_F=30$ mA
HOA1404-002		0.8				(1)
HOA1404-003		2.0				
Collector-Emitter Saturation Voltage	$V_{CE(SAT)}$				V	$I_F=30$ mA (1)
HOA1404-001				0.4		$I_C=30$ μ A
HOA1404-002				0.4		$I_C=100$ μ A
HOA1404-003				1.1		$I_C=250$ μ A
Rise And Fall Time	t_r, t_f				μ s	$V_{CC}=5$ V, $I_C=1$ mA
HOA1404-001, -002			15			$R_L=1000$ Ω
HOA1404-003			75			$R_L=100$ Ω

Notes

1. Test surface is a front surface mirror (polished aluminum, 85% reflectance) located 0.20 in.(5.0 mm) from the front surface of the device.

ABSOLUTE MAXIMUM RATINGS

(25°C Free-Air Temperature unless otherwise noted)

Operating Temperature Range -55°C to 100°C

Storage Temperature Range -55°C to 125°C

Soldering Temperature (10 sec) 260°C

IR EMITTER

Power Dissipation 75 mW (1)

Reverse Voltage 3 V

Continuous Forward Current 50 mA

DETECTOR

Collector-Emitter Voltage 30 V

Emitter-Collector Voltage 5 V

Power Dissipation 75 mW (1) 75 mW (1)

Collector DC Current 30 mA 30 mA

SCHEMATIC

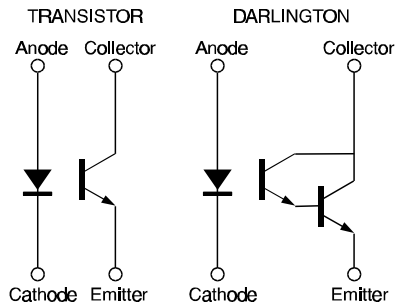

Honeywell reserves the right to make changes in order to improve design and supply the best products possible.

Honeywell

249

HOA1404

Reflective Sensor

Fig. 1 IRED Forward Bias Characteristics

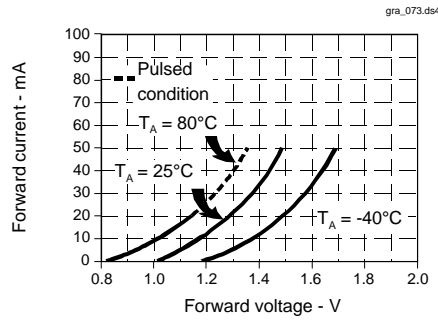

Fig. 2 Non-Saturated Switching Time vs Load Resistance

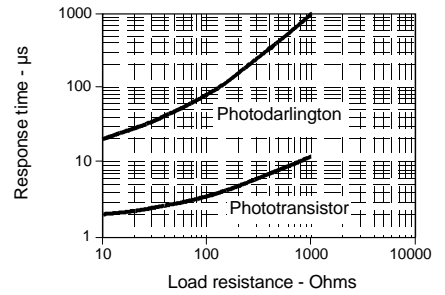

Fig. 3 Dark Current vs Temperature

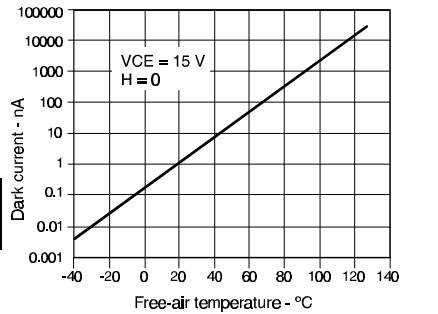

Fig. 4 Collector Current vs Ambient Temperature

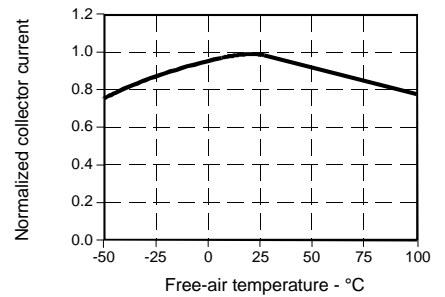

Fig. 5 Collector Current vs Distance to Reflective Surface

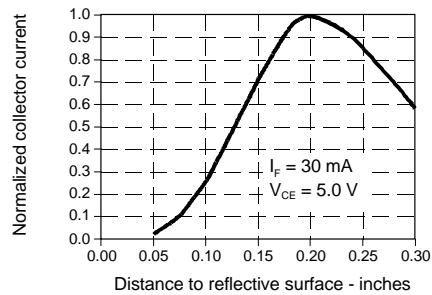
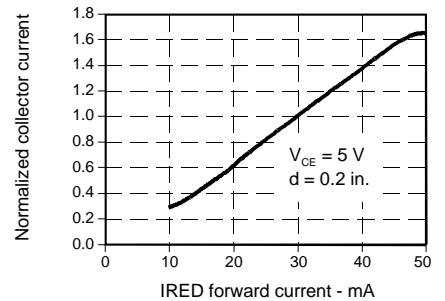

Fig. 6 Collector Current vs IRED Forward Current



All Performance Curves Show Typical Values

HOA1404

Reflective Sensor



Honeywell reserves the right to make changes in order to improve design and supply the best products possible.

Honeywell

251