



**40CTQ045**  
**40CTQ045S**  
**40CTQ045-1**

**SCHOTTKY RECTIFIER**

**40 Amp**

$$I_{F(AV)} = 40\text{Amp}$$

$$V_R = 45\text{V}$$

**Major Ratings and Characteristics**



Characteristics	Values	Units
$I_{F(AV)}$ Rectangular waveform	40	A
$V_{RRM}$	45	V
$I_{FSM}$ @ tp = 5 $\mu$ s sine	1240	A
$V_F$ @ 20 Apk, $T_J = 125^\circ\text{C}$ (per leg)	0.48	V
$T_J$ range	-55 to 150	$^\circ\text{C}$

**Description/ Features**

This center tap Schottky rectifier has been optimized for very low forward voltage drop, with moderate leakage. The proprietary barrier technology allows for reliable operation up to 150° C junction temperature. Typical applications are in switching power supplies, converters, free-wheeling diodes, and reverse battery protection.

- 150° C  $T_J$  operation
- Center tap configuration
- Very low forward voltage drop
- High purity, high temperature epoxy encapsulation for enhanced mechanical strength and moisture resistance
- High frequency operation
- Guard ring for enhanced ruggedness and long term reliability

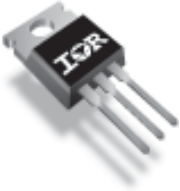
**Case Styles**

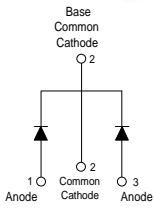
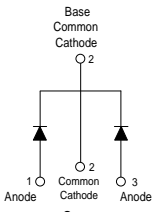
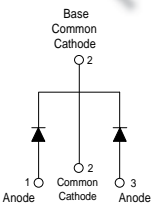
40CTQ...	40CTQ... S	40CTQ... -1
		
<p>Base Common Cathode ○ 2</p>  <p>1○ Anode    2○ Common Cathode    3○ Anode</p> <p><b>TO-220</b></p>	<p>Base Common Cathode ○ 2</p>  <p>1○ Anode    2○ Common Cathode    3○ Anode</p> <p><b>D²PAK</b></p>	<p>Base Common Cathode ○ 2</p>  <p>1○ Anode    2○ Common Cathode    3○ Anode</p> <p><b>TO-262</b></p>

## Voltage Ratings

Parameters	40CTQ045 40CTQ045S 40CTQ045-1
$V_R$ Max. DC Reverse Voltage (V)	45
$V_{RWM}$ Max. Working Peak Reverse Voltage (V)	

## Absolute Maximum Ratings

Parameters	Values	Units	Conditions
$I_{F(AV)}$ Max. Average Forward Current (Per Leg) * See Fig. 5 (Per Device)	20 40	A	50% duty cycle @ $T_C = 116^\circ\text{C}$ , rectangular wave form
$I_{FSM}$ Max. Peak One Cycle Non-Repetitive Surge Current (Per Leg) * See Fig. 7	1240 350	A	5 $\mu\text{s}$ Sine or 3 $\mu\text{s}$ Rect. pulse 10ms Sine or 6ms Rect. pulse Following any rated load condition and with rated $V_{RRM}$ applied
$E_{AS}$ Non-Repetitive Avalanche Energy (Per Leg)	20	mJ	$T_J = 25^\circ\text{C}$ , $I_{AS} = 3\text{ Amps}$ , $L = 4.40\text{ mH}$
$I_{AR}$ Repetitive Avalanche Current (Per Leg)	3	A	Current decaying linearly to zero in 1 $\mu\text{sec}$ Frequency limited by $T_J$ max. $V_A = 1.5 \times V_R$ typical

## Electrical Specifications

Parameters	Values	Units	Conditions
$V_{FM}$ Max. Forward Voltage Drop (Per Leg) * See Fig. 1 (1)	0.53	V	@ 20A $T_J = 25^\circ\text{C}$
	0.68	V	@ 40A
	0.48	V	@ 20A $T_J = 125^\circ\text{C}$
	0.67	V	@ 40A
$I_{RM}$ Max. Reverse Leakage Current (Per Leg) * See Fig. 2 (1)	3	mA	$T_J = 25^\circ\text{C}$
	115	mA	$T_J = 125^\circ\text{C}$ $V_R = \text{rated } V_R$
$V_{F(TO)}$ Threshold Voltage	0.27	V	$T_J = T_J \text{ max.}$
$r_t$ Forward Slope Resistance	8.72	m $\Omega$	
$C_T$ Max. Junction Capacitance (Per Leg)	2800	pF	$V_R = 5V_{DC}$ , (test signal range 100Khz to 1Mhz) $25^\circ\text{C}$
$L_S$ Typical Series Inductance (Per Leg)	8.0	nH	Measured lead to lead 5mm from package body
dv/dt Max. Voltage Rate of Change (Rated $V_R$ )	10000	V/ $\mu\text{s}$	

(1) Pulse Width < 300 $\mu\text{s}$ , Duty Cycle <2%

## Thermal-Mechanical Specifications

Parameters	Values	Units	Conditions
$T_J$ Max. Junction Temperature Range	-55 to 150	$^\circ\text{C}$	
$T_{stg}$ Max. Storage Temperature Range	-55 to 150	$^\circ\text{C}$	
$R_{thJC}$ Max. Thermal Resistance Junction to Case (Per Leg)	2.0	$^\circ\text{C/W}$	DC operation
$R_{thJC}$ Max. Thermal Resistance Junction to Case (Per Package)	1.0	$^\circ\text{C/W}$	DC operation
$R_{thCS}$ Typical Thermal Resistance, Case to Heatsink	0.50	$^\circ\text{C/W}$	Mounting surface, smooth and greased (only for TO-220)
wt Approximate Weight	2 (0.07)	g (oz.)	
T Mounting Torque	Min.	6 (5)	Kg-cm (lbf-in)
	Max.	12 (10)	

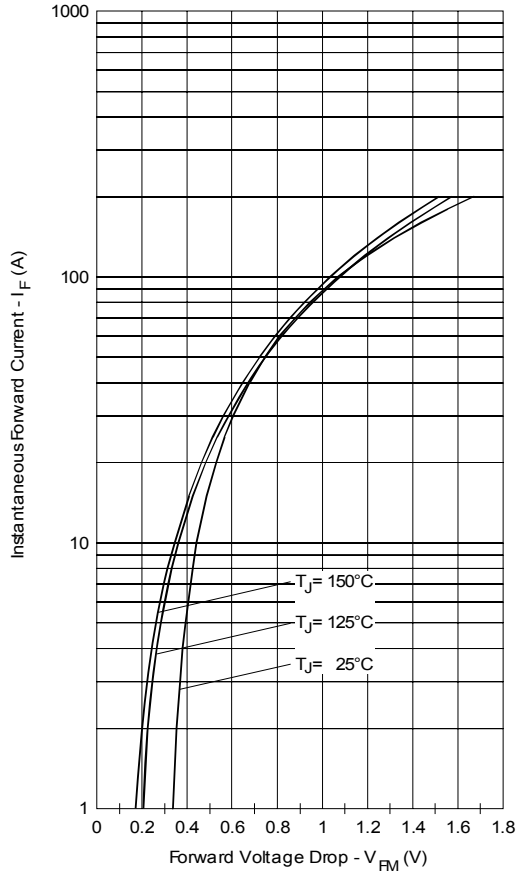

Fig. 1 - Max. Forward Voltage Drop Characteristics (Per Leg)

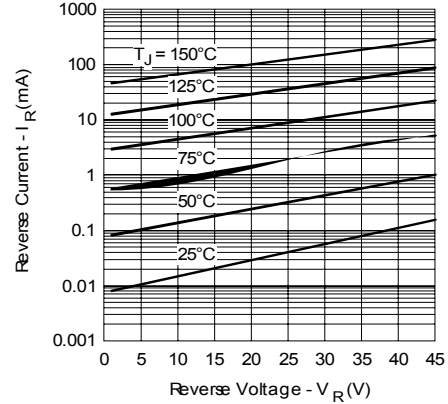

Fig. 2 - Typical Values Of Reverse Current Vs. Reverse Voltage (Per Leg)

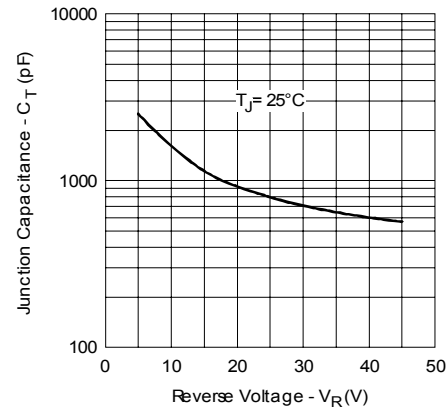

Fig. 3 - Typical Junction Capacitance Vs. Reverse Voltage (Per Leg)

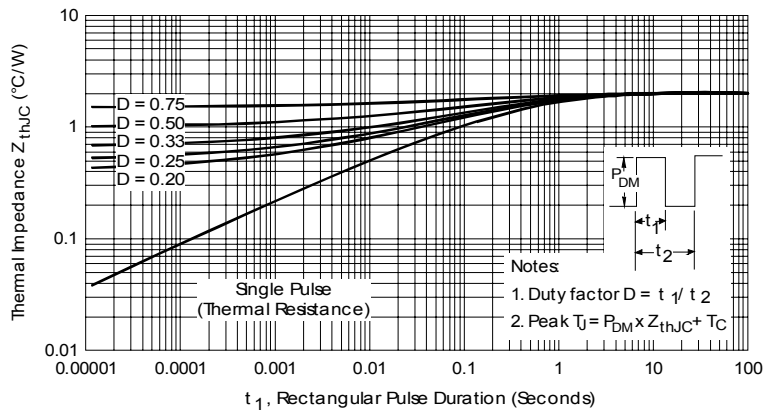

Fig. 4 - Max. Thermal Impedance  $Z_{thJC}$  Characteristics (Per Leg)

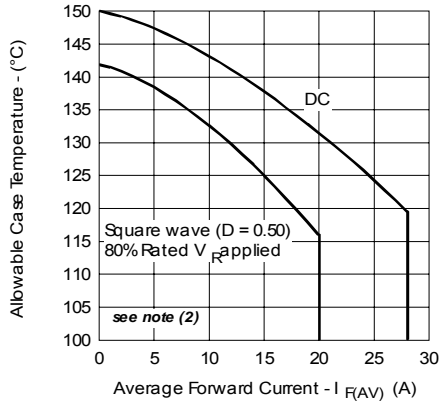

Fig. 5 - Max. Allowable Case Temperature Vs. Average Forward Current (Per Leg)

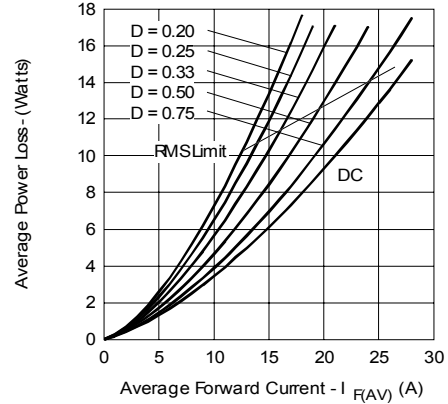

Fig. 6 - Forward Power Loss Characteristics (Per Leg)

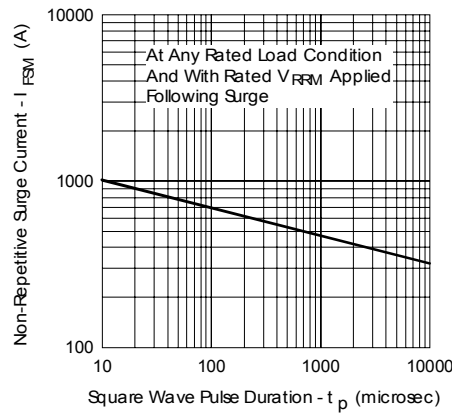

Fig. 7 - Max. Non-Repetitive Surge Current (Per Leg)

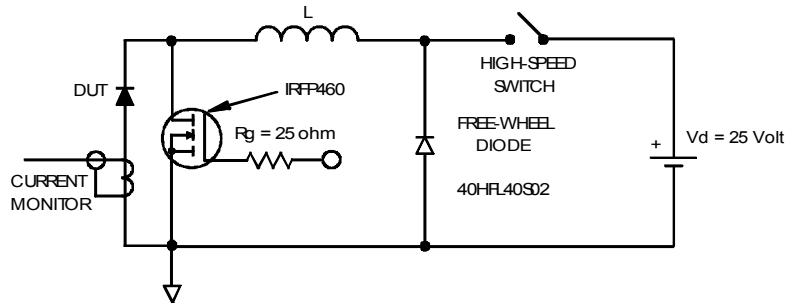
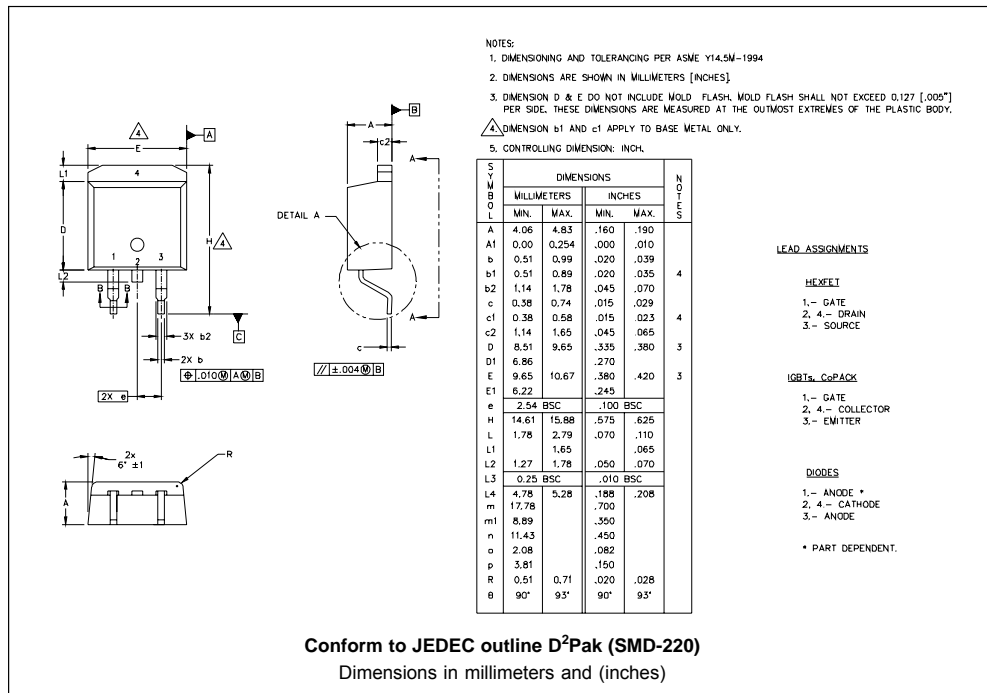
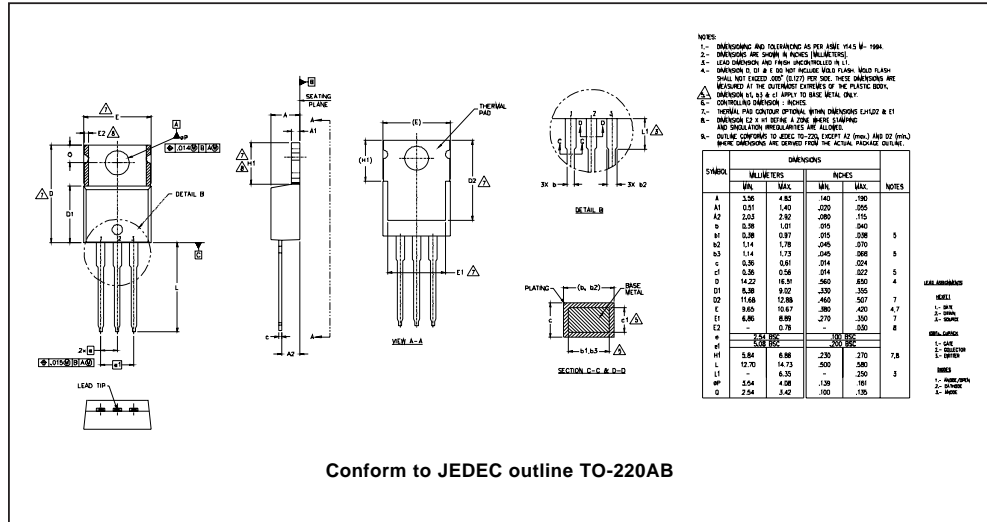

Fig. 8 - Unclamped Inductive Test Circuit

- (2) Formula used:  $T_c = T_j - (P_d + P_{d_{REV}}) \times R_{INJC}$ ;  
 $P_d = \text{Forward Power Loss} = I_{F(AV)} \times V_{FM} @ (I_{F(AV)} / D)$  (see Fig. 6);  
 $P_{d_{REV}} = \text{Inverse Power Loss} = V_{R1} \times I_R (1 - D)$ ;  $I_R @ V_{R1} = 10 \text{ V}$

Outline Table



Outline Table

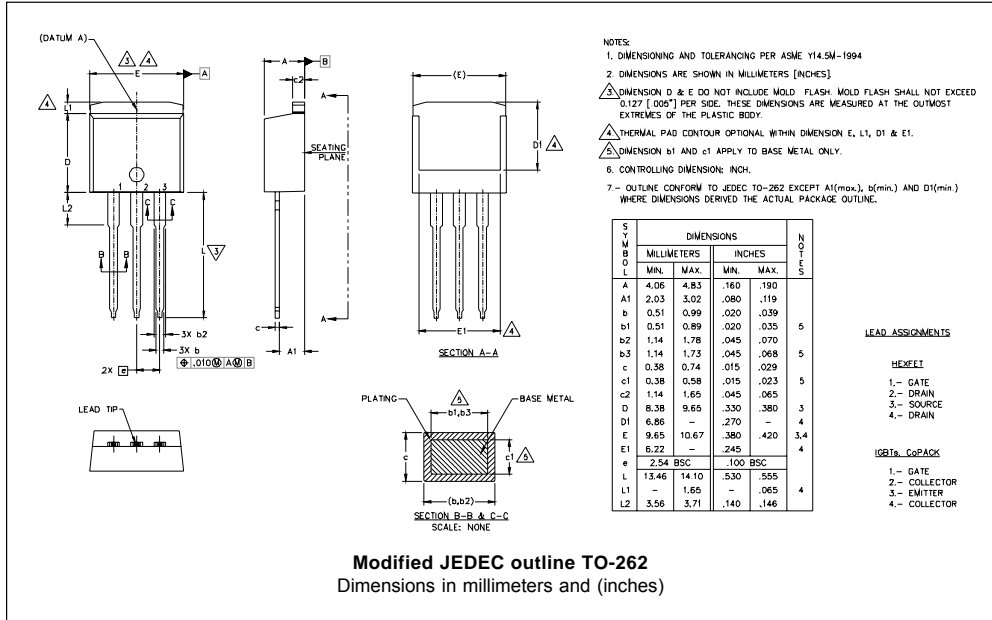

Tape & Reel Information

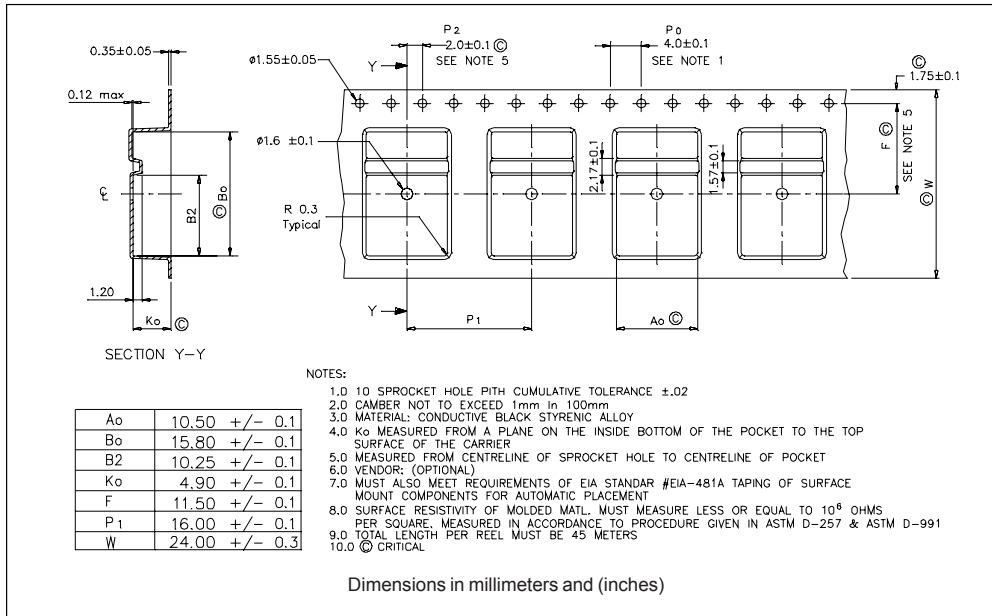

Part Marking Information

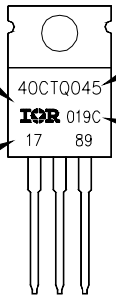
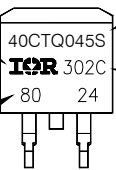
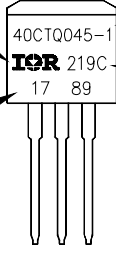
<p><b>TO-220</b></p> <p>EXAMPLE: THIS IS A 40CTQ045            LOT CODE 1789            ASSEMBLED ON WW 19, 2000            IN THE ASSEMBLY LINE "C"</p>	 <p>INTERNATIONAL RECTIFIER LOGO</p> <p>ASSEMBLY LOT CODE</p> <p>PART NUMBER</p> <p>DATE CODE        YEAR 0 = 2000        WEEK 19        LINE C</p>
<p><b>D<sup>2</sup>PAK</b></p> <p>EXAMPLE: THIS IS A 40CTQ045S            LOT CODE 8024            ASSEMBLED ON WW 02, 2003            IN ASSEMBLY LINE "C"</p>	 <p>INTERNATIONAL RECTIFIER LOGO</p> <p>ASSEMBLY LOT CODE</p> <p>PART NUMBER</p> <p>DATE CODE        YEAR 3 = 2003        WEEK 02        LINE C</p>
<p><b>TO-262</b></p> <p>EXAMPLE: THIS IS A 40CTQ045-1            LOT CODE 1789            ASSEMBLED ON WW 19, 2002            IN ASSEMBLY LINE "C"</p>	 <p>INTERNATIONAL RECTIFIER LOGO</p> <p>ASSEMBLY LOT CODE</p> <p>PART NUMBER</p> <p>DATE CODE        YEAR 2 = 2002        WEEK 19        LINE C</p>

Ordering Information Table

Device Code																	
	<table border="1" style="margin: auto;"> <tr> <td style="padding: 5px;">40</td> <td style="padding: 5px;">C</td> <td style="padding: 5px;">T</td> <td style="padding: 5px;">Q</td> <td style="padding: 5px;">045</td> <td style="padding: 5px;">S</td> <td style="padding: 5px;">TRL</td> <td style="padding: 5px;">-</td> </tr> <tr> <td style="text-align: center;">①</td> <td style="text-align: center;">②</td> <td style="text-align: center;">③</td> <td style="text-align: center;">④</td> <td style="text-align: center;">⑤</td> <td style="text-align: center;">⑥</td> <td style="text-align: center;">⑦</td> <td style="text-align: center;">⑧</td> </tr> </table>	40	C	T	Q	045	S	TRL	-	①	②	③	④	⑤	⑥	⑦	⑧
40	C	T	Q	045	S	TRL	-										
①	②	③	④	⑤	⑥	⑦	⑧										
<b>1</b>	- Current Rating (40A)																
<b>2</b>	- Circuit Configuration C = Common Cathode																
<b>3</b>	- T = TO-220																
<b>4</b>	- Schottky "Q" Series																
<b>5</b>	- Voltage Rating (45 = 45V)																
<b>6</b>	- • S = D <sup>2</sup> Pak • -1= TO-262																
<b>7</b>	- • none = Tube (50 pieces) • TRL = Tape & Reel (Left Oriented - for D <sup>2</sup> Pak only) • TRR = Tape & Reel (Right Oriented - for D <sup>2</sup> Pak only)																
<b>8</b>	- • none = Standard Production • PbF = Lead-Free																

Data and specifications subject to change without notice.  
 This product has been designed and qualified for Industrial Level.  
 Qualification Standards can be found on IR's Web site.