

# HFA15PB60

HEXFRED™

Ultrafast, Soft Recovery Diode

### Features

- Ultrafast Recovery
- Ultrasoft Recovery
- Very Low  $I_{RRM}$
- Very Low  $Q_{rr}$
- Specified at Operating Conditions

### Benefits

- Reduced RFI and EMI
- Reduced Power Loss in Diode and Switching Transistor
- Higher Frequency Operation
- Reduced Snubbing
- Reduced Parts Count

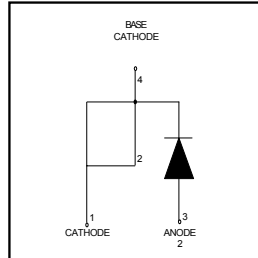

$V_R = 600V$
$V_F(\text{typ.})^* = 1.3V$
$I_{F(AV)} = 15A$
$Q_{rr}(\text{typ.}) = 80nC$
$I_{RRM}(\text{typ.}) = 4.0A$
$t_{rr}(\text{typ.}) = 19ns$
$di_{(rec)}/dt(\text{typ.})^* = 160A/\mu s$

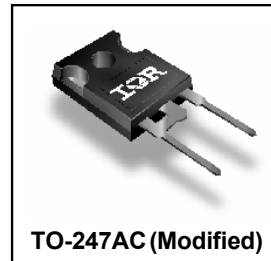

### Description

International Rectifier's HFA15PB60 is a state of the art ultra fast recovery diode. Employing the latest in epitaxial construction and advanced processing techniques it features a superb combination of characteristics which result in performance which is unsurpassed by any rectifier previously available. With basic ratings of 600 volts and 15 amps continuous current, the HFA15PB60 is especially well suited for use as the companion diode for IGBTs and MOSFETs. In addition to ultra fast recovery time, the HEXFRED product line features extremely low values of peak recovery current ( $I_{RRM}$ ) and does not exhibit any tendency to "snap-off" during the  $t_b$  portion of recovery. The HEXFRED features combine to offer designers a rectifier with lower noise and significantly lower switching losses in both the diode and the switching transistor. These HEXFRED advantages can help to significantly reduce snubbing, component count and heatsink sizes. The HEXFRED HFA15PB60 is ideally suited for applications in power supplies and power conversion systems (such as inverters), motor drives, and many other similar applications where high speed, high efficiency is needed.

### Absolute Maximum Ratings

	Parameter	Max	Units
$V_R$	Cathode-to-Anode Voltage	600	V
$I_F @ T_C = 100^\circ C$	Continuous Forward Current	15	A
$I_{FSM}$	Single Pulse Forward Current	150	
$I_{FRM}$	Maximum Repetitive Forward Current	60	
$P_D @ T_C = 25^\circ C$	Maximum Power Dissipation	74	W
$P_D @ T_C = 100^\circ C$	Maximum Power Dissipation	29	
$T_J$	Operating Junction and	-55 to +150	C
$T_{STG}$	Storage Temperature Range		

\* 125°C

Document Number: 93062

www.vishay.com

1

**Electrical Characteristics @ T<sub>J</sub> = 25°C (unless otherwise specified)**

	Parameter	Min	Typ	Max	Units	Test Conditions
V <sub>BR</sub>	Cathode Anode Breakdown Voltage	600			V	I <sub>R</sub> = 100μA
V <sub>FM</sub>	Max Forward Voltage		1.3	1.7	V	I <sub>F</sub> = 15A
			1.5	2.0		I <sub>F</sub> = 30A
			1.2	1.6		I <sub>F</sub> = 15A, T <sub>J</sub> = 125°C
I <sub>RM</sub>	Max Reverse Leakage Current		1.0	10	μA	V <sub>R</sub> = V <sub>R</sub> Rated
			400	1000		T <sub>J</sub> = 125°C, V <sub>R</sub> = 0.8 x V <sub>R</sub> Rated
C <sub>T</sub>	Junction Capacitance		25	50	pF	V <sub>R</sub> = 200V
L <sub>S</sub>	Series Inductance		12		nH	Measured lead to lead 5mm from package body

**Dynamic Recovery Characteristics @ T<sub>J</sub> = 25°C (unless otherwise specified)**

	Parameter	Min	Typ	Max	Units	Test Conditions
t <sub>rr</sub>	Reverse Recovery Time		19		ns	I <sub>F</sub> = 1.0A, di <sub>F</sub> /dt = 200A/μs, V <sub>R</sub> = 30V
t <sub>rr1</sub>	See Fig. 5, 10		42	60		T <sub>J</sub> = 25°C
t <sub>rr2</sub>			74	120		T <sub>J</sub> = 125°C
I <sub>RRM1</sub>	Peak Recovery Current		4.0	6.0	A	T <sub>J</sub> = 25°C
I <sub>RRM2</sub>	See Fig. 6		6.5	10		T <sub>J</sub> = 125°C
Q <sub>rr1</sub>	Reverse Recovery Charge		80	180	nC	T <sub>J</sub> = 25°C
Q <sub>rr2</sub>	See Fig. 7		220	600		T <sub>J</sub> = 125°C
di <sub>(rec)M</sub> /dt1	Peak Rate of Fall of Recovery Current		188		A/μs	T <sub>J</sub> = 25°C
di <sub>(rec)M</sub> /dt2	During t <sub>b</sub> See Fig. 8		160			T <sub>J</sub> = 125°C

**Thermal - Mechanical Characteristics**

	Parameter	Min	Typ	Max	Units
T <sub>lead</sub> <sup>①</sup>	Lead Temperature			300	°C
R <sub>thJC</sub>	Thermal Resistance, Junction to Case			1.7	K/W
R <sub>thJA</sub> <sup>②</sup>	Thermal Resistance, Junction to Ambient			40	
R <sub>thCS</sub> <sup>③</sup>	Thermal Resistance, Case to Heat Sink		0.25		
Wt	Weight		6.0		g
			0.21		(oz)
	Mounting Torque		6.0	12	Kg-cm
			5.0	10	lbf·in

① 0.063 in. from Case (1.6mm) for 10 sec

② Typical Socket Mount

③ Mounting Surface, Flat, Smooth and Greased

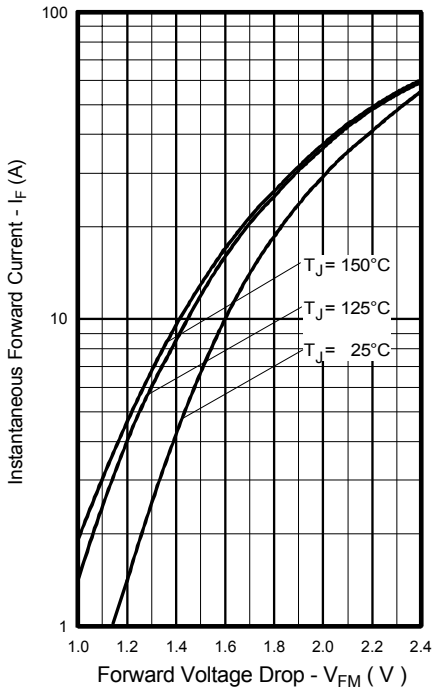

**Fig. 1** - Maximum Forward Voltage Drop vs. Instantaneous Forward Current

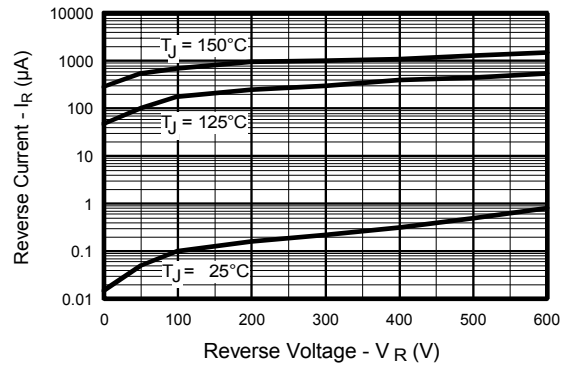

**Fig. 2** - Typical Reverse Current vs. Reverse Voltage

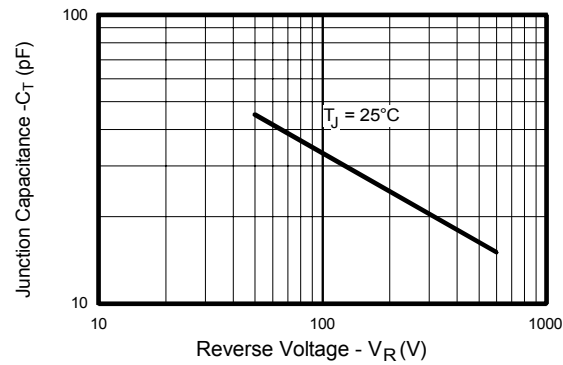

**Fig. 3** - Typical Junction Capacitance vs. Reverse Voltage

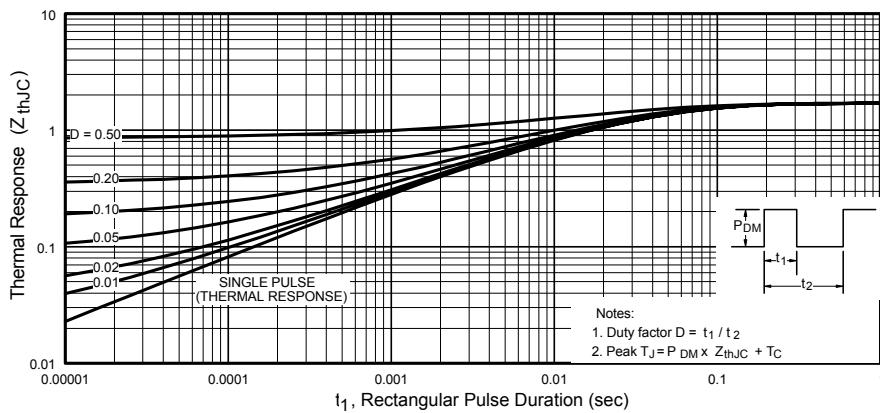

**Fig. 4** - Maximum Thermal Impedance  $Z_{thjC}$  Characteristics

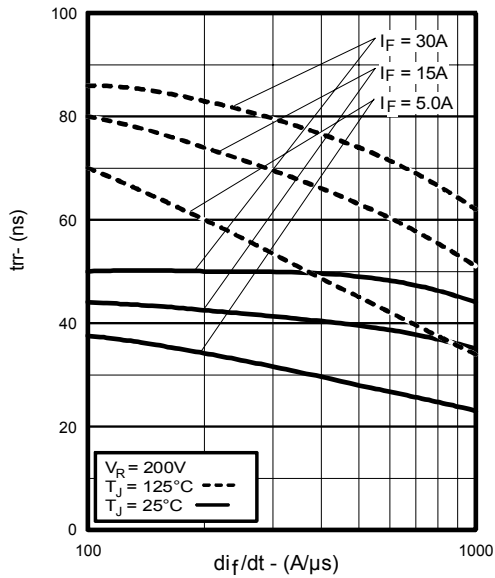

Fig. 5 - Typical Reverse Recovery Time vs.  $di_f/dt$

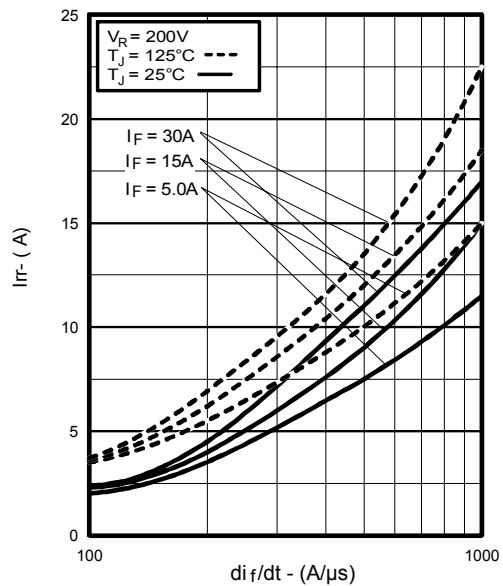

Fig. 6 - Typical Recovery Current vs.  $di_f/dt$

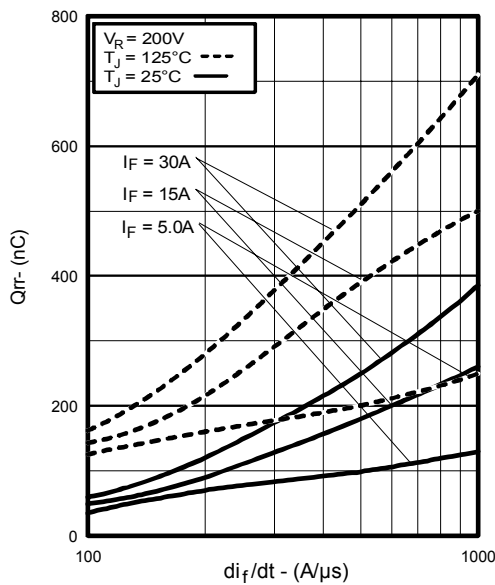

Fig. 7 - Typical Stored Charge vs.  $di_f/dt$

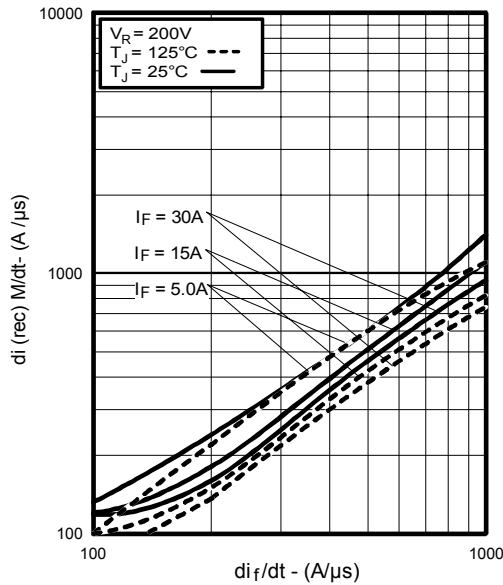
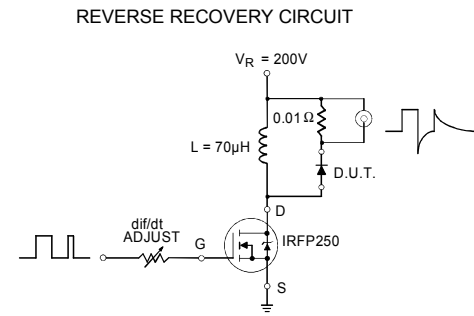
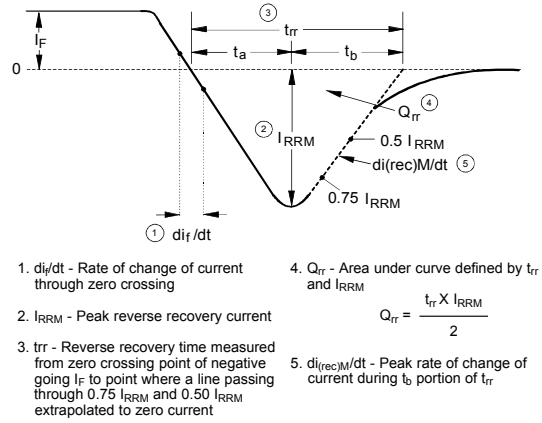

Fig. 8 - Typical  $di_{(rec)M}/dt$  vs.  $di_f/dt$



**Fig. 9 - Reverse Recovery Parameter Test Circuit**

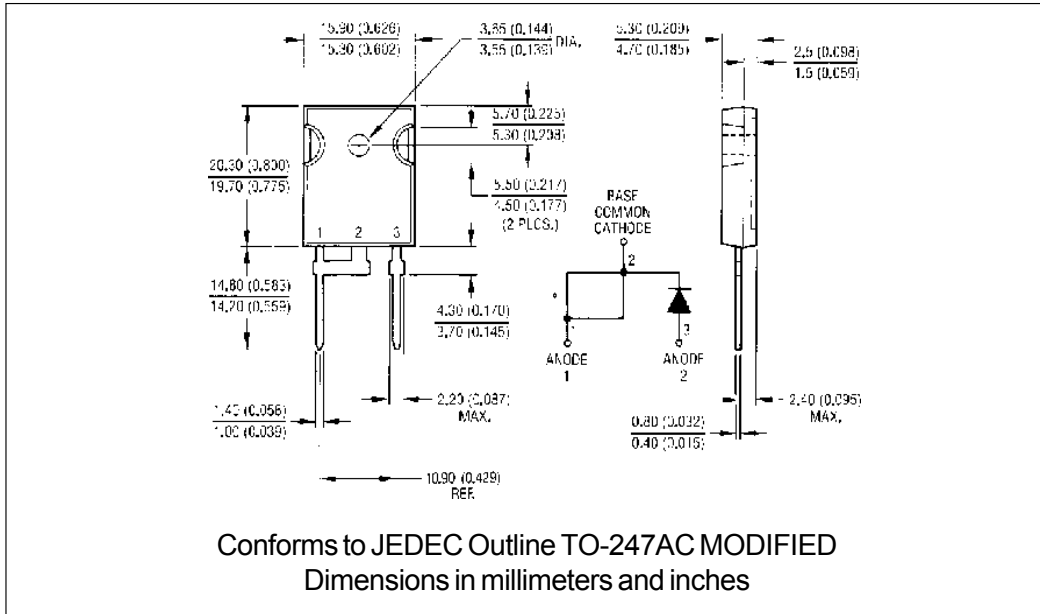

**Fig. 10 - Reverse Recovery Waveform and Definitions**

# HFA15PB60

Bulletin PD-2.340 rev. A 11/00

International  
**IR** Rectifier



International  
**IR** Rectifier

**WORLD HEADQUARTERS:** 233 Kansas St., El Segundo, California 90245 U.S.A. Tel: (310) 322 3331. Fax: (310) 322 3332.  
**EUROPEAN HEADQUARTERS:** Hurst Green, Oxted, Surrey RH8 9BB, U.K. Tel: ++ 44 1883 732020. Fax: ++ 44 1883 733408.  
**IR CANADA:** 15 Lincoln Court, Brampton, Markham, Ontario L6T3Z2. Tel: (905) 453 2200. Fax: (905) 475 8801.  
**IR GERMANY:** Saalburgstrasse 157, 61350 Bad Homburg. Tel: ++ 49 6172 96590. Fax: ++ 49 6172 965933.  
**IR ITALY:** Via Liguria 49, 10071 Borgaro, Torino. Tel: ++ 39 11 4510111. Fax: ++ 39 11 4510220.  
**IR FAR EAST:** K&H Bldg., 2F, 30-4 Nishi-Ikebukuro 3-Chome, Toshima-Ku, Tokyo, Japan 171. Tel: 81 3 3983 0086.  
**IR SOUTHEAST ASIA:** 1 Kim Seng Promenade, Great World City West Tower, 13-11, Singapore 237994. Tel: ++ 65 838 4630.  
**IR TAIWAN:** 16 Fl. Suite D.207, Sec. 2, Tun Haw South Road, Taipei, 10673, Taiwan. Tel: 886 2 2377 9936.

*Data and specifications subject to change without notice.*

Document Number: 93062

www.vishay.com

6



## Notice

The products described herein were acquired by Vishay Intertechnology, Inc., as part of its acquisition of International Rectifier's Power Control Systems (PCS) business, which closed in April 2007. Specifications of the products displayed herein are pending review by Vishay and are subject to the terms and conditions shown below.

Specifications of the products displayed herein are subject to change without notice. Vishay Intertechnology, Inc., or anyone on its behalf, assumes no responsibility or liability for any errors or inaccuracies.

Information contained herein is intended to provide a product description only. No license, express or implied, by estoppel or otherwise, to any intellectual property rights is granted by this document. Except as provided in Vishay's terms and conditions of sale for such products, Vishay assumes no liability whatsoever, and disclaims any express or implied warranty, relating to sale and/or use of Vishay products including liability or warranties relating to fitness for a particular purpose, merchantability, or infringement of any patent, copyright, or other intellectual property right.

The products shown herein are not designed for use in medical, life-saving, or life-sustaining applications. Customers using or selling these products for use in such applications do so at their own risk and agree to fully indemnify Vishay for any damages resulting from such improper use or sale.

International Rectifier®, IR®, the IR logo, HEXFET®, HEXSense®, HEXDIP®, DOL®, INTERO®, and POWIRTRAIN® are registered trademarks of International Rectifier Corporation in the U.S. and other countries. All other product names noted herein may be trademarks of their respective owners.