



# Complete SDARS Receiver

MAX2140

## General Description

The MAX2140 complete receiver is designed for satellite digital audio radio services (SDARS). The device includes a fully monolithic VCO and only needs a SAW at the IF and a crystal to generate the reference frequency.

To form a complete SDARS radio, the MAX2140 requires only a low-noise amplifier (LNA), which can be controlled by a baseband controller. The small number of external components needed makes the MAX2140-based platform the lowest cost and the smallest solution for SDARS.

The receiver includes a self-contained RF AGC loop and baseband-controlled IF AGC loop, effectively providing a total dynamic range of over 92dB.

Channel selectivity is ensured by the SAW filter and by on-chip monolithic lowpass filters.

The fractional-N PLL allows a very small frequency step, making possible the implementation of an AFC loop. Additionally, the reference is provided by an external XTAL and on-chip oscillator. A reference buffer output is also provided.

A 2-wire interface (I<sup>2</sup>C-bus compatible) programs the circuit for a wide variety of conditions, providing features such as:

- Programmable gains
- Lowpass filters tuning
- Individual functional block shutdown

The MAX2140 minimizes the requirement on the baseband controller. No compensation or calibration procedures are required. The device is available in a 7mm x 7mm 44-pin thin QFN package.

## Applications

- Satellite Digital Audio Radio Services (SDARS)
- 2.4GHz ISM Radios

## Features

- ◆ Integrated Receiver, Requires Only One SAW Filter
- ◆ Self-Contained RF AGC Loop
- ◆ Differential I/Q Interface
- ◆ Complete Integrated Frequency Generation
- ◆ Bias Supply for External LNAs
- ◆ Overcurrent Protection
- ◆ Low-Power Standby Mode
- ◆ Very Small 44-Pin Thin QFN Package

## Ordering Information

PART	TEMP RANGE	PIN-PACKAGE
MAX2140ETH	-40°C to +85°C	44 Thin QFN-EP*
MAX2140ETH+	-40°C to +85°C	44 Thin QFN-EP*

\*EP = Exposed paddle.

+Denotes lead-free package.

## Block Diagram/Pin Configuration

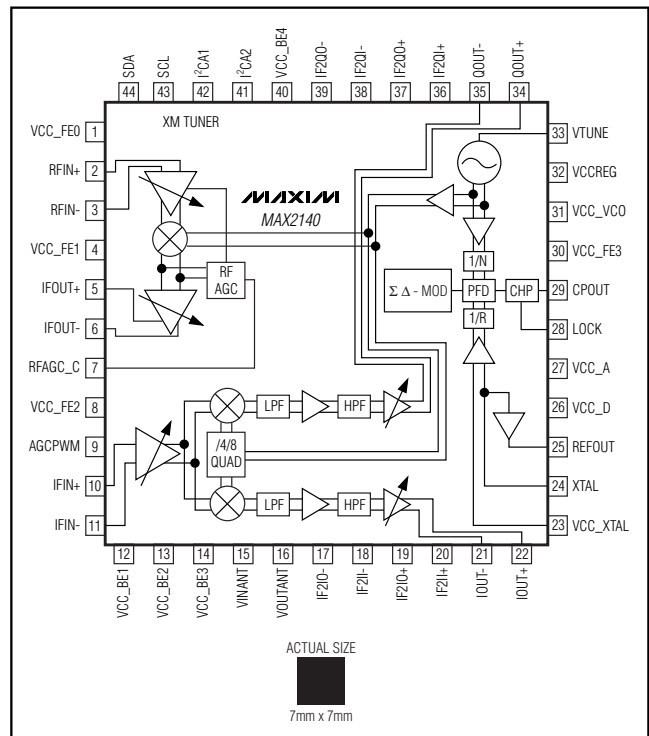

**For pricing, delivery, and ordering information, please contact Maxim/Dallas Direct! at 1-888-629-4642, or visit Maxim's website at [www.maxim-ic.com](http://www.maxim-ic.com).**

# Complete SDARS Receiver

## ABSOLUTE MAXIMUM RATINGS

V <sub>CC_XX</sub> to GND.....	-0.3V to +4.3V
VINANT to GND.....	-0.3V to +5.6V
AGCPWM to GND.....	-0.3V to +3.0V
Digital Input Current.....	±10mA
Maximum VSWR Without Damage.....	4:1
Maximum VSWR Without Oscillations.....	4:1
All Other Pins.....	-0.3V to V <sub>CC</sub> + 0.3V

Continuous Power Dissipation (T <sub>A</sub> = +70°C)	44-Pin TQFN (derate 26.31mW/°C above +70°C) ... 2105mW
Operating Temperature Range.....	-40°C to +85°C
Junction Temperature.....	+150°C
Theta J <sub>C</sub> .....	12°C/W
Storage Temperature Range.....	-65°C to +150°C
Lead Temperature (soldering, 10s).....	+300°C

Stresses beyond those listed under "Absolute Maximum Ratings" may cause permanent damage to the device. These are stress ratings only, and functional operation of the device at these or any other conditions beyond those indicated in the operational sections of the specifications is not implied. Exposure to absolute maximum rating conditions for extended periods may affect device reliability.



**CAUTION!** ESD SENSITIVE DEVICE

## DC ELECTRICAL CHARACTERISTICS

(V<sub>CC</sub> = 3.1V to 3.6V; VINANT ≥ V<sub>CC</sub>, VOUTANT in open circuit, T<sub>A</sub> = -40°C to +85°C. Typical values are at V<sub>CC</sub> = 3.3V, VINANT = 3.3V, and T<sub>A</sub> = +25°C, unless otherwise noted.) (Note 1)

PARAMETER	SYMBOL	CONDITIONS	MIN	TYP	MAX	UNITS
Supply Voltage Range (Note 2)	V <sub>CC</sub>		3.1	3.3	3.6	V
	VINANT		3.1	3.3	5.3	
Operating Supply Current	I <sub>CC</sub>	All blocks on		150	180	mA
	I <sub>SHDN</sub>	All blocks off		30		μA
Lock Indicator High (Locked)	V <sub>IH_LK</sub>		V <sub>CC</sub> - 0.5			V
Lock Indicator Low (Unlocked)	V <sub>IL_LK</sub>				0.5	V
Digital Input-Logic High	V <sub>IH</sub>		V <sub>CC</sub> - 0.5			V
Digital Input-Logic Low	V <sub>IL</sub>				0.5	V
Input Current for Digital Control Pins	I <sub>DIG</sub>		-1		+1	μA
Input Current for AGCPWM	I <sub>AGCPWM</sub>		-10		+290	μA
Voltage Drop VINANT to VOUTANT in Normal Operating Mode	V <sub>ANTDC-DROP</sub>	Maximum current sink at VOUTANT is 150mA			0.35	V
Current Sink at VOUTANT to Flag Bit ACP = 1	I <sub>ANTDC_H</sub>	VOUTANT shorted to ground (Note 4)	195		500	mA
Current Sink at VOUTANT to Flag Bit AND = 1	I <sub>ANTDC_L</sub>		12	20	30	mA

# Complete SDARS Receiver

MAX2140

## AC ELECTRICAL CHARACTERISTICS

(MAX2140 EV kit, current drawn at V<sub>OUTANT</sub>, I<sub>VOUTANT</sub> = 150mA max, V<sub>CC</sub> = 3.1V to 3.6V, V<sub>INANT</sub> = 3.1V to 5.3V, f<sub>RF</sub> = 2320MHz to 2345MHz, f<sub>LO</sub> = 2076MHz, T<sub>A</sub> = -40°C to +85°C. Typical values are at V<sub>CC</sub> = V<sub>INANT</sub> = 3.3V, f<sub>RF</sub> = 2338MHz, T<sub>A</sub> = +25°C, unless otherwise noted.) (Note 2)

Interstage (IF) 259MHz SAW filter specification: insertion loss = 19dB max, 9.3MHz to 12MHz from center attenuation = 24dB min, beyond 12MHz from center attenuation = 40dB min.

PARAMETER	SYMBOL	CONDITIONS	MIN	TYP	MAX	UNITS
<b>GENERAL RECEIVER</b>						
Minimum Input RF Power to Produce 20mV <sub>P-P</sub> (Differential) at I and Q Baseband Outputs	P <sub>MIN</sub>	IF AGC is set at maximum gain, bit HPF = 0 (Note 4)		-91	-84	dBm
Maximum Input RF Power to Produce 400mV <sub>P-P</sub> (Differential) at I and Q Baseband Outputs	P <sub>MAX</sub>	RF AGC threshold: RF_AGC_TRIP = -17dBm; IF AGC is set at minimum gain, bit HPF = 0		+3		dBm
LO to RF Input Leakage	P <sub>LK_H</sub>	LO-related spurious > 2GHz		-66		dBm
	P <sub>LK_L</sub>	LO-related spurious < 2GHz		-38		
Noise Figure (Notes 3, 5)	NF	RF AGC is at maximum gain, IF AGC is at reference gain		8.5	10.4	dB
		RF AGC is at maximum gain, IF AGC is at reference gain -10dB		9.3	11.7	
		RF AGC is at maximum gain -5dB, IF AGC is at reference gain		13.3	15.5	
		RF AGC is at maximum gain -10dB, IF AGC is at reference gain		17.8	21.5	
In-Band Input IP3 (Notes 5, 6)	I_IIP3	RF AGC is at maximum gain, IF AGC is at reference gain		-32		dBm
		RF AGC is at maximum gain, IF AGC is at reference gain -5dB		-27		
		RF AGC is at maximum gain -30dB, IF AGC is at reference gain -43dB		+9		
		RF AGC is at maximum gain -20dB, IF AGC is at reference gain -53dB		+6		
Out-of-Band Input IP3 (Notes 5, 7)	O_IIP3	RF AGC is at maximum gain, IF AGC is at reference gain		-9		dBm
		RF AGC is at maximum gain -7dB, IF AGC is at reference gain		-3		
		RF AGC is at maximum gain -25dB, IF AGC is at reference gain		+12		

# Complete SDARS Receiver

## AC ELECTRICAL CHARACTERISTICS (continued)

(MAX2140 EV kit, current drawn at VOUTANT, I<sub>VOUTANT</sub> = 150mA max, V<sub>CC</sub> = 3.1V to 3.6V, VINANT = 3.1V to 5.3V, f<sub>RF</sub> = 2320MHz to 2345MHz, f<sub>LO</sub> = 2076MHz, T<sub>A</sub> = -40°C to +85°C. Typical values are at V<sub>CC</sub> = VINANT = 3.3V, f<sub>RF</sub> = 2338MHz, T<sub>A</sub> = +25°C, unless otherwise noted.) (Note 2)

Interstage (IF) 259MHz SAW filter specification: insertion loss = 19dB max, 9.3MHz to 12MHz from center attenuation = 24dB min, beyond 12MHz from center attenuation = 40dB min.

PARAMETER	SYMBOL	CONDITIONS	MIN	TYP	MAX	UNITS
In-Band Input IP2 (Notes 5, 6)	I <sub>IIP2</sub>	RF AGC is at maximum gain, IF AGC is at reference gain		+1		dBm
		RF AGC is at maximum gain, IF AGC is at reference gain -5dB		+6		
		RF AGC is at maximum gain, IF AGC is at reference gain -25dB		+27		
Out-of-Band Input IP2 (Notes 5, 7)	O <sub>IIP2</sub>	RF AGC is at maximum gain, IF AGC is at reference gain		+38		dBm
		RF AGC is at maximum gain -7dB, IF AGC is at reference gain		+45		
		RF AGC is at maximum gain -25dB, IF AGC is at reference gain		+60		
Opposite Sideband Rejection	OSR	Baseband frequencies = 100kHz (Note 4)	32	39		dB
Image Rejection	IRej	At f <sub>LO</sub> - f <sub>IF</sub>		54		dB
Half IF Rejection	HRej	At f <sub>LO</sub> + 0.5 x f <sub>IF</sub>		53		dB
<b>RF AGC LOOP</b>						
LNA Gain Reduction	RFAGC_ Range	(Note 4)	30	42		dB
Minimum RF AGC Trip Point	RFAGC_min	Bits RF4/3/2/1/0 = 00000 (BIN)		-35		dBm
RF AGC Trip Point	RFAGC_int	Bits RF4/3/2/1/0 = 00010 (BIN) (Note 4)	-37	-33	-29	dBm
Maximum RF AGC Trip Point	RFAGC_max	Bits RF4/3/2/1/0 = 10100 (BIN)		-15		dBm
<b>FRONT-END (FE) PROGRAMMABLE GAIN</b>						
FE Programmable Gain Range	FE_Rge	(Note 4)	19	22	26	dB
FE Programmable Gain Step	FE_Step			2		dB
<b>IF FILTER INTERFACE</b>						
IF Output Differential Admittance	Y <sub>out, IF</sub>	Between pins IFOUT+, IFOUT-, f <sub>IF</sub> = 259MHz and 467MHz		1/900 + j0		S
Input Differential Impedance Presented by the IC to the IF Filter Output	Z <sub>in, IF</sub>	Between pins IFOUT+, IFOUT-, f <sub>IF</sub> = 259MHz and 467MHz		150 + j0		Ω
<b>IF AGC LOOP</b>						
IF AGC Control Voltage for Max Gain	IFAGC_VM	Applied at pin AGCPWM		0.2		V
IF AGC Control Voltage for Min Gain	IFAGC_Vm	Applied at pin AGCPWM		2.5		V

# Complete SDARS Receiver

MAX2140

## AC ELECTRICAL CHARACTERISTICS (continued)

(MAX2140 EV kit, current drawn at VOUTANT, I<sub>VOUTANT</sub> = 150mA max, V<sub>CC</sub> = 3.1V to 3.6V, VINANT = 3.1V to 5.3V, f<sub>RF</sub> = 2320MHz to 2345MHz, f<sub>LO</sub> = 2076MHz, T<sub>A</sub> = -40°C to +85°C. Typical values are at V<sub>CC</sub> = VINANT = 3.3V, f<sub>RF</sub> = 2338MHz, T<sub>A</sub> = +25°C, unless otherwise noted.) (Note 2)

Interstage (IF) 259MHz SAW filter specification: insertion loss = 19dB max, 9.3MHz to 12MHz from center attenuation = 24dB min, beyond 12MHz from center attenuation = 40dB min.

PARAMETER	SYMBOL	CONDITIONS	MIN	TYP	MAX	UNITS
IF AGC Gain-Control Range	IFAGC_Rge	(Note 4)	47		64	dB
<b>INTERNAL BASEBAND LOWPASS FILTERS</b>						
LPF In-Band Ripple	LPFA_rip	From 0 to 6.3MHz with respect to the amplitude at 100kHz		0.7		dB
LPF Out-of-Band Rejection (Note 4)	LPFrej	At 10.25MHz with respect to the amplitude at 2MHz	14	21		dB
	LPFrej	At 16MHz with respect to the amplitude at 2MHz	47	51		
<b>INTERNAL OUTPUT STAGE</b>						
Gain Increase	BB_DG	From bit HPF = 0 to HPF = 1		4		dB
Maximum I/QOUT± Pin Loading	IQ_load	Per each of the four pins		10//10		kΩ//pF
<b>FREQUENCY GENERATION: VCO AND PLL</b>						
VCO Frequency Range	VCO_Range	Over V <sub>CHP</sub> range (Note 4)	1861		2079	MHz
VCO Tuning Gain	VCO_Gain	(Note 4)			240	MHz/V
Synthesized VCO Phase Noise	VCO_PN	At 1kHz within PLL band		-79		dBc/Hz
		At 10kHz outside PLL band		-80		
		At 100kHz outside PLL band		-101		
Synthesized VCO Phase-Noise Jitter	VCO_jit	Integrated from 100Hz to 100kHz, LO frequency = 2079MHz		1.2		DegRMS
Charge-Pump Voltage Range	V <sub>CHP</sub>		0.40		2.75	V
Charge-Pump Current	I <sub>CHP</sub>	Bit CHP = 0		0.6		mA
		Bit CHP = 1		1.2		
Pin CHP Leakage Current	CHP_leak	Across V <sub>CHP</sub> range		5		nA
PLL Reference Division Ratio	PLLref		1		2	
Synthesized VCO Smallest Fractional Step	PLLstep	Programmable through I <sup>2</sup> C		23		Hz

# Complete SDARS Receiver

## AC ELECTRICAL CHARACTERISTICS (continued)

(MAX2140 EV kit, current drawn at VOUTANT, I<sub>VOUTANT</sub> = 150mA max, V<sub>CC</sub> = 3.1V to 3.6V, VINANT = 3.1V to 5.3V, f<sub>RF</sub> = 2320MHz to 2345MHz, f<sub>LO</sub> = 2076MHz, T<sub>A</sub> = -40°C to +85°C. Typical values are at V<sub>CC</sub> = VINANT = 3.3V, f<sub>RF</sub> = 2338MHz, T<sub>A</sub> = +25°C, unless otherwise noted.) (Note 2)

Interstage (IF) 259MHz SAW filter specification: insertion loss = 19dB max, 9.3MHz to 12MHz from center attenuation = 24dB min, beyond 12MHz from center attenuation = 40dB min.

PARAMETER	SYMBOL	CONDITIONS	MIN	TYP	MAX	UNITS
Synthesized VCO Spurs	VCOspur	0Hz < f <sub>offset</sub> < 10kHz	(Note 9)			dBc
		10kHz < f <sub>offset</sub> < 1MHz	(Note 9)			
		1MHz < f <sub>offset</sub> < 10MHz	-47			
XTAL Oscillator Frequency Range	XTALrge		24		49	MHz
XTAL Oscillator Frequency Error	XTALerror	Using an external XTAL (Note 8)	-16		+16	ppm
XTAL Oscillator Input Voltage	XTALswing	Using an external TCXO	0.8		V <sub>CC</sub>	V <sub>P-P</sub>
XTAL Oscillator Input Duty Cycle	XTALduty	Using an external TCXO	47	50	53	%
Reference Buffer Output Voltage	REFV	Using the REFOUT pin loading specified below (Note 4)	0.95	1.10		V <sub>P-P</sub>
Reference Buffer Output Duty Cycle	REFduty	Using an external XTAL, not overdriven; bit RFD = 0, using the REFOUT pin loading specified below	45	50	55	%
Maximum REFOUT Pin Loading	REFOUT_1d	REFOUT pin frequency = 24MHz	20			pF
		REFOUT pin frequency = 48MHz	8			

## TIMING CHARACTERISTICS

PARAMETER	SYMBOL	CONDITIONS	MIN	TYP	MAX	UNITS
<b>SERIAL INTERFACE (Note 2)</b>						
Serial Clock Frequency	f <sub>SCL</sub>			200		kHz

**Note 1:** At T<sub>A</sub> = -40°C, minimum and maximum values are guaranteed by design and characterization.

**Note 2:** Minimum and maximum values are guaranteed by design and characterization, unless otherwise noted.

**Note 3:** At T<sub>A</sub> = +25°C, minimum and maximum values are guaranteed by design and characterization.

**Note 4:** At T<sub>A</sub> = +25°C and T<sub>A</sub> = +85°C, parameters are production tested.

**Note 5:** IF AGC reference level is defined as being the required voltage applied on pin AGCPWM, and the corresponding receiver IF gain, to measure 20mV<sub>P-P</sub> at each I/Q differential output when the RF input power is -91dBm. If even for zero volts applied on pin AGCPWM the I/Q differential outputs are below 20mV<sub>P-P</sub> when the RF input power is -91dBm, then the reference level is defined as zero volts.

**Note 6:** In-band IP2 and IP3 are measured with two CW tones at RF input: f<sub>1</sub> = 2339.55MHz, f<sub>2</sub> = 2339.75MHz.

**Note 7:** Out-of-band IP2 and IP3 are measured with two CW tones at RF input: f<sub>1</sub> = 2326.25MHz, f<sub>2</sub> = 2330.25MHz.

**Note 8:** Error computed using a crystal with no error.

**Note 9:** No spur in the offset frequency range.

# Complete SDARS Receiver

## Typical Operating Characteristics

( $T_A = +25^\circ\text{C}$ , unless otherwise noted.)

MAX2140

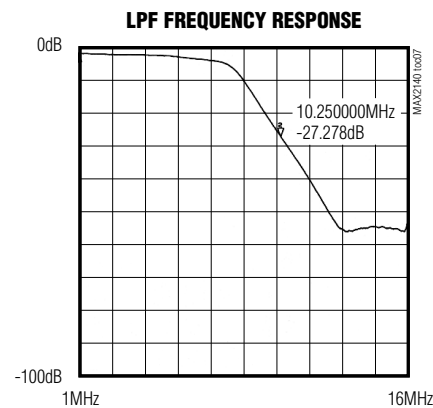
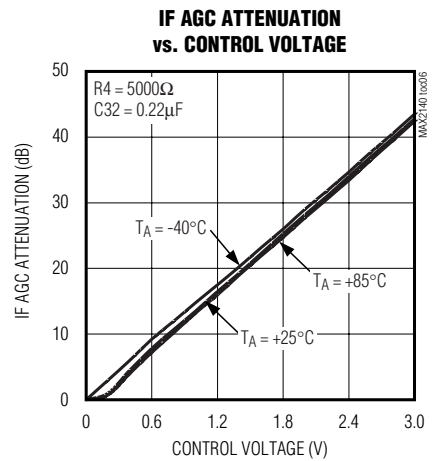
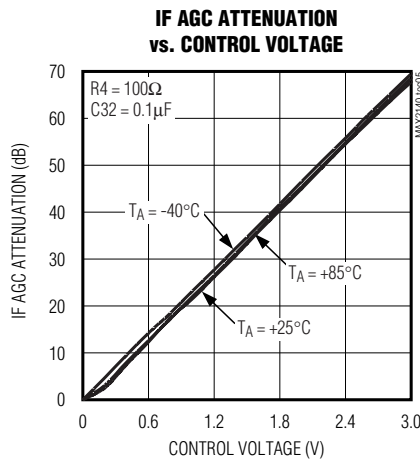
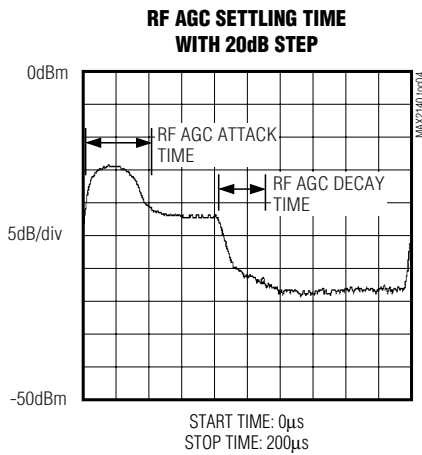
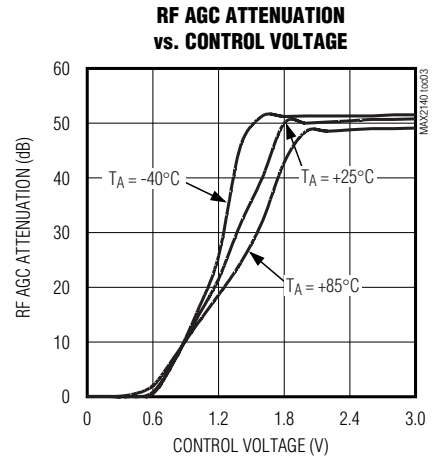
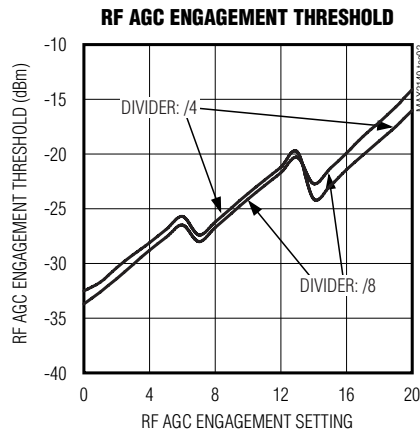
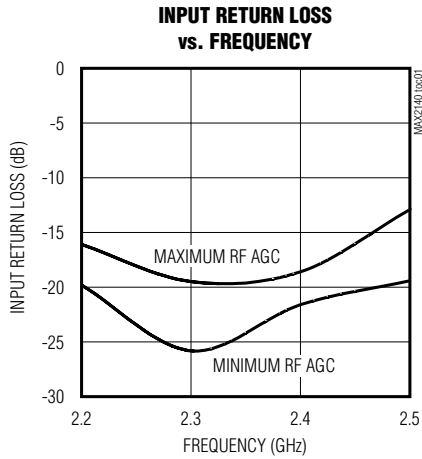

# Complete SDARS Receiver

## Typical Operating Characteristics (continued)

(T<sub>A</sub> = +25°C, unless otherwise noted.)

**LPF GROUP DELAY vs. FREQUENCY**

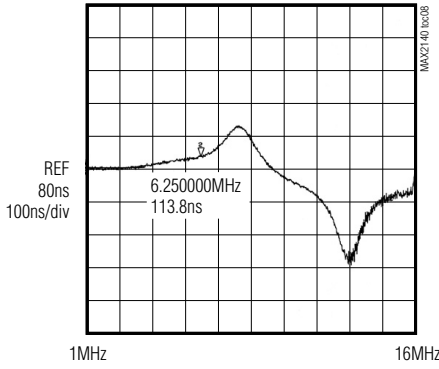

**VCO PHASE NOISE vs. OFFSET FREQUENCY**

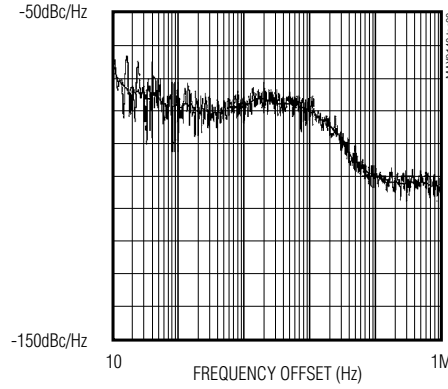

**REFOUT WAVEFORM (REF = 0, RFD = 0)**

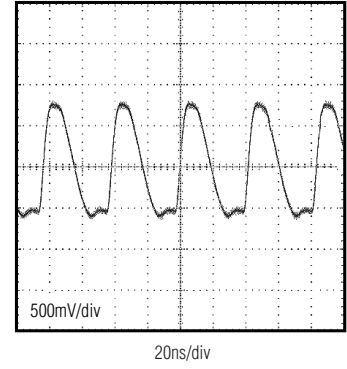

**REFOUT WAVEFORM (REF = 1, RFD = 0)**

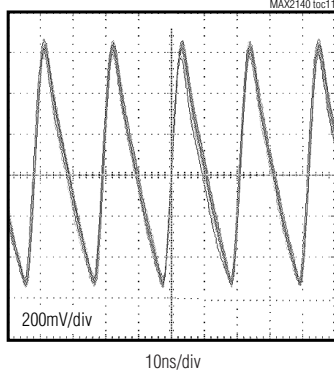

**REFOUT WAVEFORM (REF = 1, RFD = 1)**

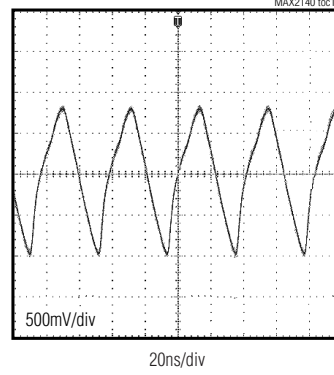



# Complete SDARS Receiver

## Pin Description

**MAX2140**

PIN	NAME	FUNCTION
1, 4, 8, 12–15, 23, 26, 27, 30, 31, 40	VCC_FE0, VCC_FE1, VCC_FE2, VCC_BE1, VCC_BE2, VCC_BE3, VINANT, VCC_XTAL, VCC_D, VCC_A, VCC_FE3, VCC_VCO, VCC_BE4	Power Supplies. Bypass to ground with capacitors as close to the pins as possible.
2, 3	RFIN+, RFIN-	Differential RF Inputs. Accept RF input signal from the SDARS cabled antenna with a 50Ω to 100Ω balun.
5, 6	IFOUT+, IFOUT-	Differential First IF Output. Connect an external SAW filter to the IF output.
7	RFAGC_C	RF AGC Power-Detector Output. Set the RF AGC attack and decay response times.
9	AGCPWM	IF AGC Control Voltage Input. Input from the filtered PWM AGC control signal from the SDARS channel-decoder IC.
10, 11	IFIN+, IFIN-	Differential First IF Input
16	VOUTANT	Overcurrent-Protected Unregulated DC Supply Output. Provides DC power supply to the antenna module.
17, 19, 37, 39	IF2IO-, IF2IO+, IF2QO+, IF2QO-	Differential Baseband DC Blocking Outputs. IF2IO- = Inverting in-phase baseband output. AC couple to pin 18. IF2IO+ = Noninverting in-phase baseband output. AC couple to pin 20. IF2QO+ = Noninverting quadrature baseband output. AC couple to pin 36. IF2QO- = Inverting quadrature baseband output. AC couple to pin 38.
18, 20, 36, 38	IF2II-, IF2II+, IF2QI+, IF2QI-	Differential Baseband DC Blocking Inputs. IF2II- = Inverting in-phase baseband input. AC couple to pin 16. IF2II+ = Noninverting in-phase baseband input. AC couple to pin 19. IF2QI+ = Noninverting quadrature baseband input. AC couple to pin 37. IF2QI- = Inverting quadrature baseband input. AC couple to pin 39.
21, 22, 34, 35	IOUT-, IOUT+, QOUT+, QOUT-	Differential I/Q Baseband Outputs. IOUT- = Inverting in-phase baseband output. IOUT+ = Noninverting in-phase baseband output. QOUT+ = Noninverting quadrature baseband output. QOUT- = Inverting quadrature baseband output.
24	XTAL	Crystal Reference Input
25	REFOUT	Buffered System Clock Output. Provides clock signal to the SDARS channel-decoder IC.
28	LOCK	Digital Logic Output to the System Controller. Indicates the lock status of the internal PLL.
29	CPOUT	VCO Charge-Pump Output
32	VCCREG	Regulated Supply Voltage for the VCO
33	VTUNE	High-Impedance VCO Tuning Input
41, 42	I <sup>2</sup> CA2, I <sup>2</sup> CA1	I <sup>2</sup> C Input Signals. Define the MAX2140 I <sup>2</sup> C device address.
43, 44	SCL, SDA	I <sup>2</sup> C-Compatible Programming Input. Connect to an I <sup>2</sup> C-compatible bus.
—	Exposed Pad	Exposed Paddle. Connect to ground.

# Complete SDARS Receiver

## Detailed Description

### Front End

The front end of the MAX2140, which downconverts the RF signal to IF, is defined from the differential RF inputs (pins RFIN+ and RFIN-) to the output (pins IFOUT+ and IFOUT-) to the SAW filter.

The front end includes a self-contained analog RF AGC loop. The engagement threshold of the loop can be programmed from -35dBm to -15dBm referred to the RF input in 1dB steps using the RF4–RF0 programming bits. The time constant of the loop is set externally by the capacitor connected to RFAGC\_C.

The image reject first mixer ensures a good image and half IF rejection.

The front-end gain can be reduced by programming bits PM3–PM0 over a 22dB range, with a step of 2dB. This allows the selections of SAW filters with different insertion loss.

The IF output is nominally 900Ω differentially and requires pullup inductors to V<sub>CC</sub>, which can be used as part of the matching network to the SAW filter impedance.

### Back End

The back end, which downconverts the IF signal to quadrature baseband, is defined from the SAW filter inputs (pins IFIN+ and IFIN-) to the baseband outputs (pins IOUT+, IOUT-, QOUT+, QOUT-).

The back end contains an IF AGC loop, which is closed by the baseband controller. The IF AGC control voltage is applied at the AGCPWM pin. The gain can be reduced over 53dB (typ) and exhibits a log-linear characteristic.

The back end also contains individual lowpass filters on each channel. The lowpass-filter bandwidth is the useful SDARS downconverted bandwidth (6.25MHz). The lowpass-filter performance is factory trimmed. The bit IOT switches between the factory-trimmed set and the control through the I<sup>2</sup>C-compatible bus using bits B4–B1. Even when using the factory-trimmed set, the user can still slightly modify the cutoff frequency (by ±250kHz) by varying bits LP1/LP0.

Highpass filters are also inserted in the back-end signal paths. Their purpose is to remove the DC offset. They are designed for a low corner frequency so as not to degrade the SDARS content. Their exact cutoff frequency is set by the external capacitors connected between

IF2 access pins, given by the following equation:

$$f_{\text{cutoff}} = 1/(2 \times \pi \times R \times C) \text{ [Hz]}$$

where R = 8000Ω, C = external capacitor to be connected.

Finally, the HPF bit allows an increase to the back-end gain by 4dB at the slight expense of a degraded in-band linearity.

### Frequency Generation

An on-chip VCO and a low-step fractional-N PLL ensure the necessary frequency generation. The 1st mixer's LO is at the VCO frequency itself, while the 2nd mixer's LO is the VCO frequency divided by 4 or by 8 (bit D48). Hence, the two possible IF frequencies for SDARS are 467MHz and 259MHz. Typical applications are based on 259MHz IF frequency.

The reference divider path in the PLL can either use an external crystal and the on-chip crystal oscillator or an external TCXO that can overdrive the on-chip crystal oscillator. A reference division ratio of 1 or 2 is set by the REF bit. The crystal oscillator (or TCXO) signal is available at pin REFOUT. The output is either at the same frequency as the reference signal, or divided by two, based on the setting of bit RFD.

The VCO main division ratio is set by bits N6–N0 (for the integer part) and bits F19–F00 (for the fractional part). The minimum step is below 30Hz, small enough for effective AFC to be implemented by the baseband.

The charge-pump (pin CPOUT) is to be connected to the VCO tuning input (pin VTUNE) through an appropriate loop filter.

### Overcurrent Protection

This DC function allows external circuitry consuming up to 150mA and connected to the pin VOUTANT to sink current from a V<sub>CC</sub> line (pin VINANT) through overcurrent-protection circuitry.

When no overcurrent is present, a low dropout voltage exists between pins VINANT and VOUTANT. In overcurrent conditions (including short-circuit from VOUTANT to GND), the current is limited to approximately 300mA and bit ACP in the READ byte status goes high.

This circuit also senses if the current drawn at the pin VOUTANT is typically larger than 20mA, in which case the bit AND from the READ byte status goes high (the purpose is to inform the baseband controller if there is any device drawing current from VOUTANT).

# Complete SDARS Receiver

## Applications Information

### Serial Interface and Control Registers

#### I<sup>2</sup>C Bit Description

#### MAX2140 Programming Bits:

The MAX2140 conforms to the Philips I<sup>2</sup>C standard, 400kbps (fast mode), and operates as a slave.

The MAX2140 addresses can be selected from three values, which are determined by the logic state of the two address-select pins I<sup>2</sup>CA1 and I<sup>2</sup>CA2. In all cases, the MSB is transmitted (and read) first.

#### MAX2140 I<sup>2</sup>C-Compatible Programming Bit Definition:

##### BYTE PLLint:

RFD = reference buffer division: RFD = 0 (/1) and RFD = 1 (/2)

N6 to N0 is the binary-written main dividing ratio, integer part.

##### BYTE PLLfrac2:

PLS = Reserved: use only PLS = 0

LI1/0 = Reserved: use only LI1 = LI0 = 0

INT = Integer N mode: INT = 1 (fractional) and INT = 0 (integer)

**Table 1. MAX2140 Write Address Bytes**

AS1	AS0	MSB			ADDRESS BYTE					LSB
Low	High	1	1	0	0	0	0	1	0	
High	Low	1	1	0	0	0	1	0	0	
High	High	1	1	0	0	0	1	1	0	

**Table 2. MAX2140 Read Address Bytes**

AS1	AS0	MSB			ADDRESS BYTE					LSB
Low	High	1	1	0	0	0	0	1	1	
High	Low	1	1	0	0	0	1	0	1	
High	High	1	1	0	0	0	1	1	1	

**Table 3. MAX2140 Write Programming Bits**

WRITE-TO MODE	RESET VALUE	ADDR (hex)	MSB	CONTROL BYTE							LSB
Address	—	C2	1	1	0	0	0	0	1	0	
		C4	1	1	0	0	0	1	0	0	
		C6	1	1	0	0	0	1	1	0	
PLLint	01010110	00	RFD	N6	N5	N4	N3	N2	N1	N0	
PLLfrac2	00011110	01	PLS	LI1	LI0	INT	F19	F18	F17	F16	
PLLfrac1	10010000	02	F15	F14	F13	F12	F11	F10	F09	F08	
PLLfrac0	01101001	03	F07	F06	F05	F04	F03	F02	F01	F00	
Control	01100000	04	REF	CHP	D48	SDR	ANT	SDF	SDB	SDP	
CustomGain	00000100	05	RF4	RF3	RF2	RF1	RF0	LP1	LP0	HPF	
PMA_Test	00000000	06	PM3	PM2	PM1	PM0	SDX	T2	T1	T0	
LPFTrim	00000000	09	0	0	IOT	B4	B3	B2A	B2	B1	
Unused2	00000000	08	0	0	0	0	0	0	0	0	
Unused1	00000000	07	0	0	0	0	0	0	0	0	
Unused0	00000000	10	0	0	0	0	0	0	0	0	

# Complete SDARS Receiver

F19 to F16 is the upper-part binary-written main dividing ratio, fractional part multiplied by  $2^{20} = 1,048,576$ .

## BYTES PLLfrac1 and PLLfrac0:

F15 to F0 is the lower-part binary-written main dividing ratio, fractional part multiplied by  $2^{20} = 1,048,576$ .

## BYTE Control:

REF = reference division ratio: REF = 0 (/1) and REF = 1 (/2)

CHP = charge-pump current: CHP = 0 (0.6mA) and CHP = 1 (1.2mA)

D48 = LO division ratio: D48 = 0 (/4) and D48 = 1 (/8)

SDR = shutdown RF AGC: SDR = 0 (on) and SDR = 1 (shutdown)

ANT = antenna overcurrent protection: ANT = 0 (on) and ANT = 1 (shutdown)

SDF = shutdown front end: SDF = 0 (on) and SDF = 1 (shutdown)

SDB = shutdown back end: SDB = 0 (on) and SDB = 1 (shutdown)

SDP = shutdown PLL: SDP = 0 (on) and SDP = 1 (shutdown)

## BYTE CustomGain:

RF4/RF3/RF2/RF1/RF0 = RF AGC engagement threshold (dBm): see the RF AGC Settling Time graph in the *Typical Operating Characteristics*.

LP1/LP0 = change by 250kHz the LPF corner frequency: LP1/LP0 = 10 (nominal), LP1/LP0 = 11 (decrease), LP1/LP0 = 00 (increase)

HPF = HPF gain increase by 4dB: HPF = 0 (off) and HPF = 1 (on)

## BYTE PMA\_Test:

PM3/PM2/PM1/PM0 = PMA gain cutback (dB): PM3/PM2/PM1/PM0DEC

SDX = shutdown reference buffer: SDX = 0 (on) and SDX = 1 (shutdown)

T2/T1/T0 = test bits: 000 (normal), 001 (main division), 010 (reference division), 011 (reserved),

100 (CHP low-Z), 101 (CHP source on), 110 (CHP sink on), 111 (CHP high-Z)

## BYTE LPFTrim:

B4/B3/B2/B2A/B1 = Reserved for LPF trim. All = 0 in normal operating mode

IOT = LPF corner frequency setup: IOT = 0 (default factory trim) and IOT = 1 (controllable through I<sup>2</sup>C). IOT = 0 in normal operating mode

## BYTE Status:

RF AGC = RF AGC status: RF AGC = 0 (is not engaged) and RF AGC = 1 (engaged)

ACP = antenna current protection: ACP = 0 (no overcurrent) and ACP = 1 (overcurrent)

AND = antenna detection: ANT = 0 (current < threshold) and ANT = 1 (current > threshold)

LD = lock detect: LD = 0 (out of lock) and LD = 1 (lock)

## BYTE Reserved:

Inactive at this time, all bits are 0

**Register configuration for the LO generation when the comparison frequency = 23.92MHz:**  
to generate 2078.893333MHz:

PLLint = 01010110, PLLfrac2 = 00011110, PLLfrac1 = 10010000, PLLfrac0 = 01101001 to generate 2067.777778MHz:

PLLint = 01010110, PLLfrac2 = 00010111, PLLfrac1 = 00100001, PLLfrac0 = 00000010 to generate 1871.004000 MHz:

PLLint = 01001110, PLLfrac2 = 00010011, PLLfrac1 = 10000001, PLLfrac0 = 11111000 to generate 1861.000000MHz:

PLLint = 01001101, PLLfrac2 = 00011100, PLLfrac1 = 11010000, PLLfrac0 = 11101000

**Table 4. MAX2140 Read Programming Bits**

READ-FROM MODE	RESET VALUE	ADDRESS (hex)	MSB	CONTROL BYTE						LSB
Address	—	C3	1	1	0	0	0	0	1	1
		C5	1	1	0	0	0	1	0	1
		C7	1	1	0	0	0	1	1	1
Reserved	00000000	00	0	0	0	0	0	0	0	
Status	00000000	01	0	0	0	0	RFAGC	ACP	AND	LD

# Complete SDARS Receiver

## I<sup>2</sup>C Functional Description

### I<sup>2</sup>C Register Map:

This is the standard I<sup>2</sup>C protocol. The first byte is either C6, C4, C2 (hex) dependent on the state of the I<sup>2</sup>CA\_ pins, for a write-to-device operation and either C7, C5, C3 (hex) for a read-from operation (again dependent on the state of pins I<sup>2</sup>CA\_).

### Write Operation:

The first byte is the device address plus the direction bit ( $R/\overline{W} = 0$ ).

The second byte contains the internal address command of the first address to be accessed.

The third byte is written to the internal register directed by the command address byte.

The following bytes (if any) are written into successive internal registers.

The transfer lasts until stop conditions are encountered.

The MAX2140 acknowledges every byte transfer.

### Read Operation:

When either address C3, C5, C7 is sent, the MAX2140 sends back first the status byte then the reserved byte.

See Table 5 and Table 6 for read/write register operations.

## Layout Issues

The MAX2140 EV kit can be used as a starting point for layout. For best performance, take into consideration power-supply issues, as well as the RF, LO, and IF layout.

## Power-Supply Layout

To minimize coupling between different sections of the IC, the ideal power-supply layout is a star configuration, which has a large decoupling capacitor at a central V<sub>CC</sub> node. The V<sub>CC</sub> traces branch out from this node, each going to a separate V<sub>CC</sub> node in the MAX2140 circuit. At the end of each trace is a bypass capacitor with impedance to ground less than 1Ω at the frequency of interest. This arrangement provides local decoupling at each V<sub>CC</sub> pin. Use at least one via per bypass capacitor for a low-inductance ground connection.

## Matching Network Layout

The layout of a matching network can be very sensitive to parasitic circuit elements. To minimize parasitic inductance, keep all traces short and place components as close to the IC as possible. To minimize parasitic capacitance, a cutout in the ground plane (and any other planes) below the matching network components can be used. On the high-impedance ports (e.g., IF inputs and outputs), keep traces short to minimize shunt capacitance.

## Chip Information

TRANSISTOR COUNT: 22,000

PROCESS: BiCMOS

## Package Information

For the latest package outline information, go to [www.maxim-ic.com/packages](http://www.maxim-ic.com/packages).

**Table 5. Example: Write Registers 1 to 3 with 0E, D8, 26**

Device Address Write (C2, C4, C6)	ACK	Register Address 00	ACK	DATA 0E	ACK	DATA D8	ACK	DATA 26	ACK	STOP
-----------------------------------	-----	---------------------	-----	---------	-----	---------	-----	---------	-----	------

**Table 6. Example: Read from Status Registers (Sending an NACK Terminate Slave Transmit Mode)**

Device Address Write (C2, C4, C6)	ACK	Register Address 00	ACK	DATA 0E	ACK	DATA D8	ACK	DATA 26	ACK	STOP
-----------------------------------	-----	---------------------	-----	---------	-----	---------	-----	---------	-----	------

Maxim cannot assume responsibility for use of any circuitry other than circuitry entirely embodied in a Maxim product. No circuit patent licenses are implied. Maxim reserves the right to change the circuitry and specifications without notice at any time.

13 **Maxim Integrated Products, 120 San Gabriel Drive, Sunnyvale, CA 94086 408-737-7600**

© 2005 Maxim Integrated Products

Printed USA

**MAXIM** is a registered trademark of Maxim Integrated Products, Inc.