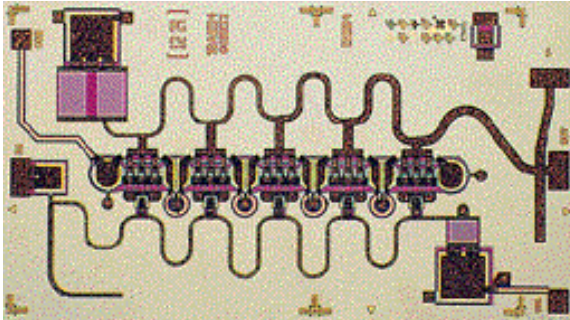

2 - 20 GHz Power Amplifier**TGA8334-SCC****Key Features and Performance**

- 2 to 20 GHz Frequency Range
- 0.4-W Output Power at 1 dB Gain Compression at Midband
- Positive Gain Slope Across Frequency
- On-Chip Input DC-Blocking Capacitor
- 1.8:1 Input SWR at Midband, 1.3:1 Output SWR at Midband
- 8 dB Gain with +/- 1 dB Flatness
- 3.1750 x 1.808 x 0.1524 mm (0.125 x 0.071 x 0.006 in.)

Description

The TriQuint TGA8334-SCC is a GaAs monolithic dual-gate distributed amplifier. Small-signal gain is typically 8 dB with positive gain slope across the band. Input and output return loss is typically greater than 9.7 dB. Five 600um gatewidth FETs provide more than 26 dB output power at 1 dB gain compression at midband. Ground is provided to the circuitry through vias to the backside metallization.

The TGA8334-SCC is directly cascadable with other broadband TriQuint GaAs amplifiers, such as the TGA8300-SCC, TGA8622-SCC, and TGA8220-SCC. This general power amplifier is suitable for a variety of wide-band applications such as distributed networks, logging stages and oscillator buffers.

Bond pad and backside metallization is gold plated for compatibility with eutectic alloy attachment methods as well as the thermocompression and thermosonic wire bonding processes. The TGA8334-SCC is supplied in chip form and is readily assembled using automated equipment.

**TYPICAL
OUTPUT POWER
P_{1dB}**

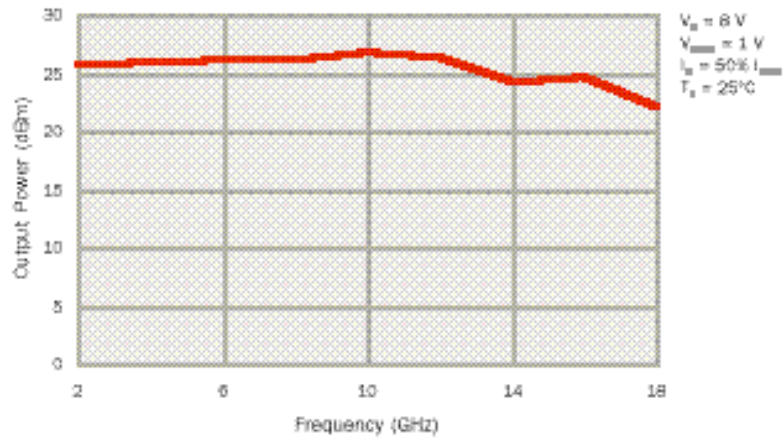

**TYPICAL
SMALL-SIGNAL
POWER GAIN**

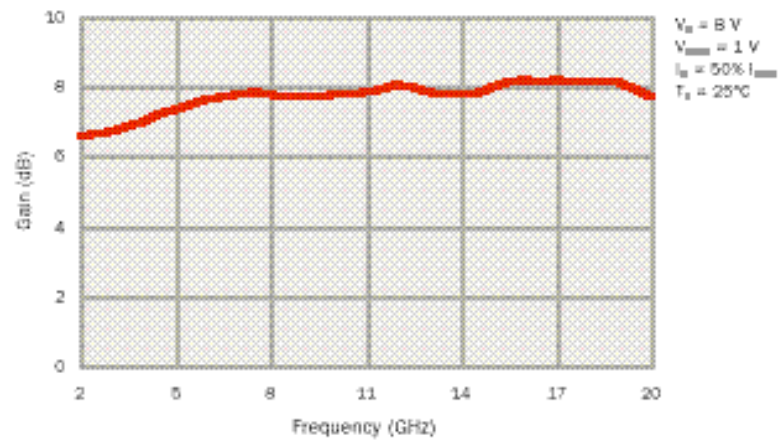

**TYPICAL
RETURN LOSS**

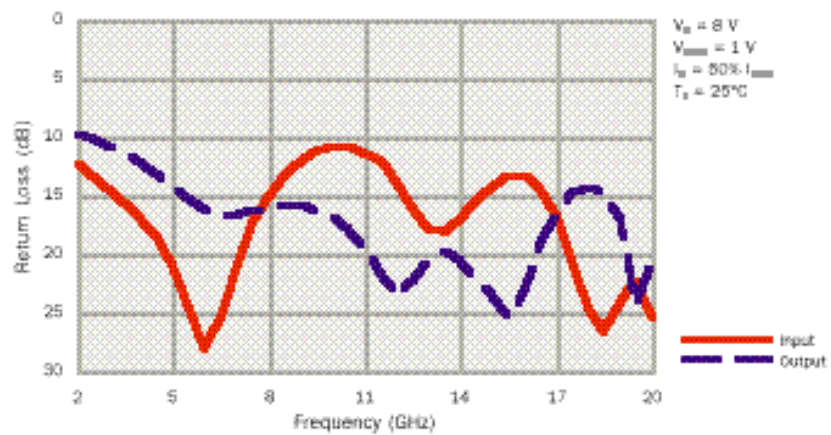

TGA8334-SCC

TABLE I
MAXIMUM RATINGS

SYMBOL	PARAMETER	VALUE
V^+	POSITIVE SUPPLY VOLTAGE	9V
I^+	POSITIVE SUPPLY CURRENT	I_{DSS}
V^-	NEGATIVE SUPPLY VOLTAGE	-5V to 0V
I^-	NEGATIVE SUPPLY CURRENT	-29.1mA
V_{CTRL}	GAIN CONTROL VOLTAGE RANGE	-5V to 4V
$V_{CTRL} - V^+$	GAIN CONTROL VOLTAGE RANGE WITH RESPECT TO POSITIVE SUPPLY VOLTAGE	0V to -10V
P_D	POWER DISSIPATION, AT (OR BELOW) 25°C BASE-PLATE TEMPERATURE *	7W
P_{IN}^{***}	INPUT CONTINUOUS WAVE POWER	27dBm
T_{CH}^{**}	OPERATING CHANNEL TEMPERATURE	150 °C
T_M	MOUNTING TEMPERATURE (30 SECONDS)	320 °C
T_{STG}	STORAGE TEMPERATURE	-65 to 150 °C

Ratings over channel temperature range, T_{CH} (unless otherwise noted)

Stresses beyond those listed under “Maximum Ratings” may cause permanent damage to the device.

These are stress ratings only, and functional operation of the device at these or any other conditions beyond those indicated under “RF Specifications” is not implied. Exposure to maximum rated conditions for extended periods may affect device reliability.

*For operation above 25°C base-plate temperature, derate linearly at the rate of 15.2mW/°C.

** Operating channel temperature, T_{CH} , directly affects the device MTTF. For maximum life, it is recommended that channel temperature be maintained at the lowest possible level.

*** See the application note included in this data sheet that references tests on samples.

TABLE II
DC PROBE TESTS (100%)
($T_A = 25\text{ }^\circ\text{C} \pm 5\text{ }^\circ\text{C}$)

NOTES	SYMBOL	TEST CONDITIONS <u>6/</u>	LIMITS		UNITS
			MIN	MAX	
<u>2/</u>	I_{DSS}	STD	630	1170	mA
<u>2/</u>	G_m	STD	300	600	mS
<u>1/</u> , <u>3/</u> , <u>7/</u>	$ V_{P1} $	STD	2.3	4.1	V
<u>1/</u> , <u>4/</u> , <u>7/</u>	$ V_{P2} $	STD	2.3	4.1	V
<u>1/</u> , <u>2/</u> , <u>5/</u>	$ V_{BVG D} $	STD	8	30	V
<u>1/</u> , <u>2/</u> , <u>5/</u>	$ V_{BVG S} $	STD	8	30	V

- 1/ V_P , $V_{BVG D}$, and $V_{BVG S}$ are negative.
- 2/ Checked for all 5 FETs in parallel.
- 3/ Pinch off voltage for Gate-1 for all FETs in parallel.
- 4/ Pinch off voltage for Gate-2 for all FETs in parallel.
- 5/ Breakdown measurements tested at 1 mA/mm with a 35 V compliance limit.
- 6/ The measurement conditions are subject to change at the manufacture's discretion (with appropriate notification to the buyer).
- 7/ $|V_{P1}|$ and $|V_{P2}|$, alternatively, may be referred to as V_{P1} and V_{P2} , respectively.
- 8/ STD refers to Standard Test Conditions, see Table IV

TABLE III
RF SPECIFICATIONS

($T_A = 25^\circ\text{C} \pm 5^\circ\text{C}$)
 $V^+ = 8\text{V}$, $I^+ = 50\% I_{DSS}$, $V_{G2} = 1.0\text{V}$

TEST	MEASUREMENT CONDITIONS	VALUE			UNITS
		MIN	TYP	MAX	
GAIN	F = 2 – 6 GHz	4.0	8.0		dB
	F = 6 – 20 GHz	5.0	8.0		dB
GAIN FLATNESS	F = 2 – 20 GHz		±1		dB
POWER OUTPUT AT 1 dB GAIN COMPRESSION	F = 2 – 14 GHz	24	26		dBm
	F = 14 – 18 GHz	21	25		dBm
INPUT RETURN LOSS MAGNITUDE	F = 2 – 20 GHz	10	14		dB
OUTPUT RETURN LOSS MAGNITUDE	F = 2 – 18 GHz	7.4	16.5		dB
	F = 18 – 20 GHz	6.0	16.5		dB
INPUT STANDING WAVE RATIO	F = 2 GHz		1.6:1		
	F = 9 GHz		1.7:1		
	F = 18 GHz		1.1:1		
OUTPUT STANDING WAVE RATIO	F = 2 GHz		2.0:1		
	F = 9 GHz		1.4:1		
	F = 18 GHz		1.5:1		
OUTPUT THIRD- ORDER INTERCEPT POINT	F = 2 GHz		38		dBm
	F = 9 GHz		41		dBm
	F = 18 GHz		38		dBm

TABLE IV
AUTOPROBE FET PARAMETER MEASUREMENT CONDITIONS

FET Parameters	Test Conditions
I_{DSS} : Maximum drain current (I_{DS}) with gate voltage (V_{GS}) at zero volts.	$V_{GS} = 0.0$ V, drain voltage (V_{DS}) is swept from 0.5 V up to a maximum of 3.5 V in search of the maximum value of I_{DS} ; voltage for I_{DSS} is recorded as VDSP.
G_m : Transconductance; $\frac{(I_{DSS} - IDS1)}{VG1}$	For all material types, V_{DS} is swept between 0.5 V and VDSP in search of the maximum value of I_{DS} . This maximum I_{DS} is recorded as IDS1. For Intermediate and Power material, IDS1 is measured at $V_{GS} = VG1 = -0.5$ V. For Low Noise, HFET and pHEMT material, $V_{GS} = VG1 = -0.25$ V. For LNBECOLC, use $V_{GS} = VG1 = -0.10$ V.
V_P : Pinch-Off Voltage; V_{GS} for $I_{DS} = 0.5$ mA/mm of gate width.	V_{DS} fixed at 2.0 V, V_{GS} is swept to bring I_{DS} to 0.5 mA/mm.
V_{BVDG} : Breakdown Voltage, Gate-to-Drain; gate-to-drain breakdown current (I_{BD}) = 1.0 mA/mm of gate width.	Drain fixed at ground, source not connected (floating), 1.0 mA/mm forced into gate, gate-to-drain voltage (V_{GD}) measured is V_{BVDG} and recorded as BVGD; this cannot be measured if there are other DC connections between gate-drain, gate-source or drain-source.
V_{BVGS} : Breakdown Voltage, Gate-to-Source; gate-to-source breakdown current (I_{BS}) = 1.0 mA/mm of gate width.	Source fixed at ground, drain not connected (floating), 1.0 mA/mm forced into gate, gate-to-source voltage (V_{GS}) measured is V_{BVGS} and recorded as BVGS; this cannot be measured if there are other DC connections between gate-drain, gate-source or drain-source.

TGA8334-SCC

TYPICAL S-PARAMETERS

Frequency (GHz)	S ₁₁		S ₂₁		S ₁₂		S ₂₂		GAIN (dB)
	MAG	ANG(°)	MAG	ANG(°)	MAG	ANG(°)	MAG	ANG(°)	
0.5	0.62	-67	2.156	154	0.001	42	0.36	-170	6.7
1.0	0.40	-103	2.092	143	0.001	65	0.35	171	6.4
1.5	0.30	-126	2.110	128	0.002	81	0.34	159	6.5
2.0	0.24	-146	2.132	113	0.003	80	0.33	150	6.6
2.5	0.21	-163	2.156	96	0.004	75	0.31	140	6.7
3.0	0.19	-180	2.181	80	0.005	66	0.29	133	6.8
3.5	0.16	166	2.213	63	0.006	56	0.27	126	6.9
4.0	0.14	151	2.241	47	0.007	46	0.24	120	7.0
4.5	0.12	138	2.294	30	0.008	32	0.22	116	7.2
5.0	0.09	128	2.338	12	0.009	18	0.19	115	7.4
5.5	0.06	125	2.374	-6	0.009	3	0.17	115	7.5
6.0	0.04	149	2.408	-24	0.009	-14	0.15	118	7.6
6.5	0.05	-178	2.431	-42	0.009	-27	0.15	122	7.7
7.0	0.09	-172	2.459	-61	0.009	-47	0.15	124	7.8
7.5	0.14	178	2.471	-79	0.008	-66	0.15	126	7.9
8.0	0.18	165	2.458	-98	0.008	-83	0.16	125	7.8
8.5	0.22	151	2.444	-117	0.008	-100	0.16	123	7.8
9.0	0.25	136	2.432	-135	0.009	-117	0.16	120	7.7
9.5	0.27	122	2.430	-153	0.010	-134	0.16	115	7.7
10.0	0.29	107	2.451	-172	0.011	-150	0.14	109	7.8
10.5	0.29	93	2.465	170	0.012	-165	0.13	104	7.8
11.0	0.27	81	2.470	151	0.013	176	0.11	97	7.9
11.5	0.25	69	2.492	132	0.014	155	0.08	98	7.9
12.0	0.20	59	2.532	111	0.014	133	0.07	115	8.1
12.5	0.16	57	2.521	90	0.012	107	0.08	134	8.0
13.0	0.13	64	2.471	70	0.007	89	0.09	133	7.9
13.5	0.12	74	2.446	51	0.004	89	0.10	123	7.8
14.0	0.14	80	2.447	31	0.003	133	0.09	114	7.8
14.5	0.17	83	2.457	10	0.006	134	0.08	108	7.8
15.0	0.19	71	2.507	-11	0.007	110	0.07	107	8.0
15.5	0.22	56	2.557	-34	0.007	80	0.05	124	8.2
16.0	0.21	38	2.572	-57	0.007	40	0.07	150	8.2
16.5	0.19	18	2.563	-80	0.005	1	0.11	153	8.2
17.0	0.14	-6	2.574	-104	0.006	-33	0.15	147	8.2
17.5	0.09	-26	2.562	-129	0.009	-75	0.18	137	8.2
18.0	0.06	-37	2.563	-154	0.012	-114	0.19	122	8.2
19.0	0.06	-42	2.561	151	0.015	179	0.14	93	8.2
19.5	0.08	-81	2.501	122	0.015	144	0.06	102	8.0
20.0	0.05	-103	2.430	94	0.015	108	0.10	-175	7.7

$V_D = 8\text{ V}, V_{CTRL} = 1\text{ V}, I_D = 50\% I_{DSS}, T_A = 25^\circ\text{C}$,

The reference planes for S-parameter data include bond wires as specified in the "Recommended Assembly Diagram." The S-parameters are also available on floppy disk and the world wide web.

TGA8334-SCC

THERMAL INFORMATION

PARAMETER	TEST CONDITION	NOM	UNIT
$R_{\theta JC}$ Thermal resistance (channel to backside)	$V_D = 8\text{ V}$, $I_D = 50\% I_{DSS}$, $V_{CTRL} = 1\text{ V}$	18.7	$^{\circ}\text{C}/\text{W}$

EQUIVALENT SCHEMATIC

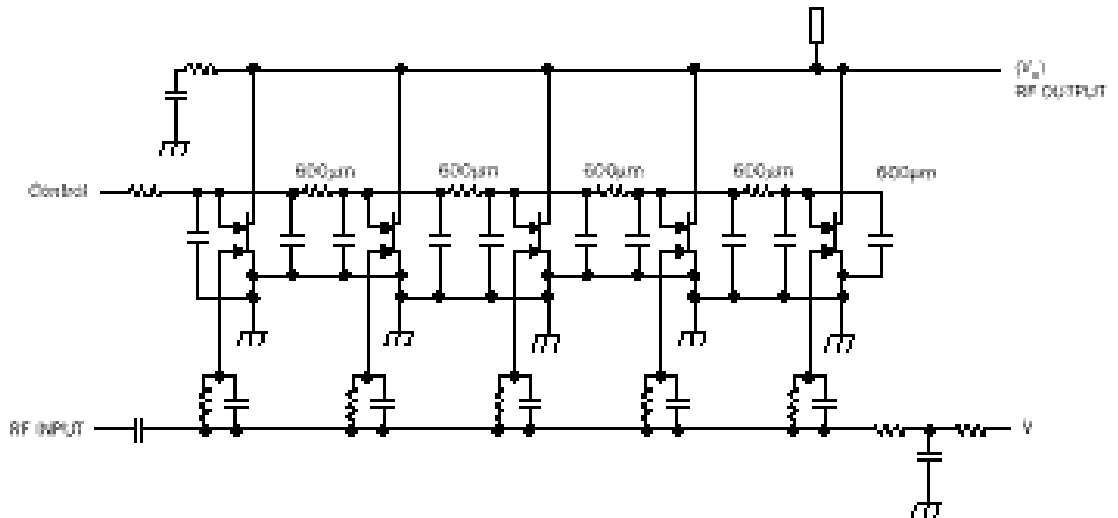

TGA8334-SCC

RECOMMENDED TEST CONFIGURATION

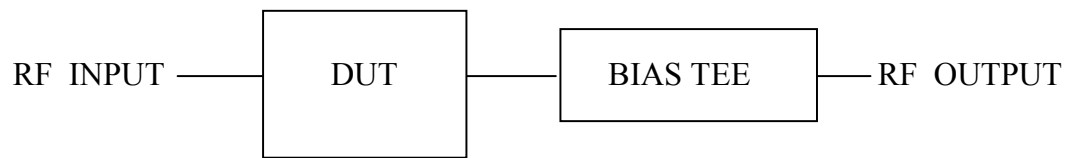

RECOMMENDED ASSEMBLY DIAGRAM

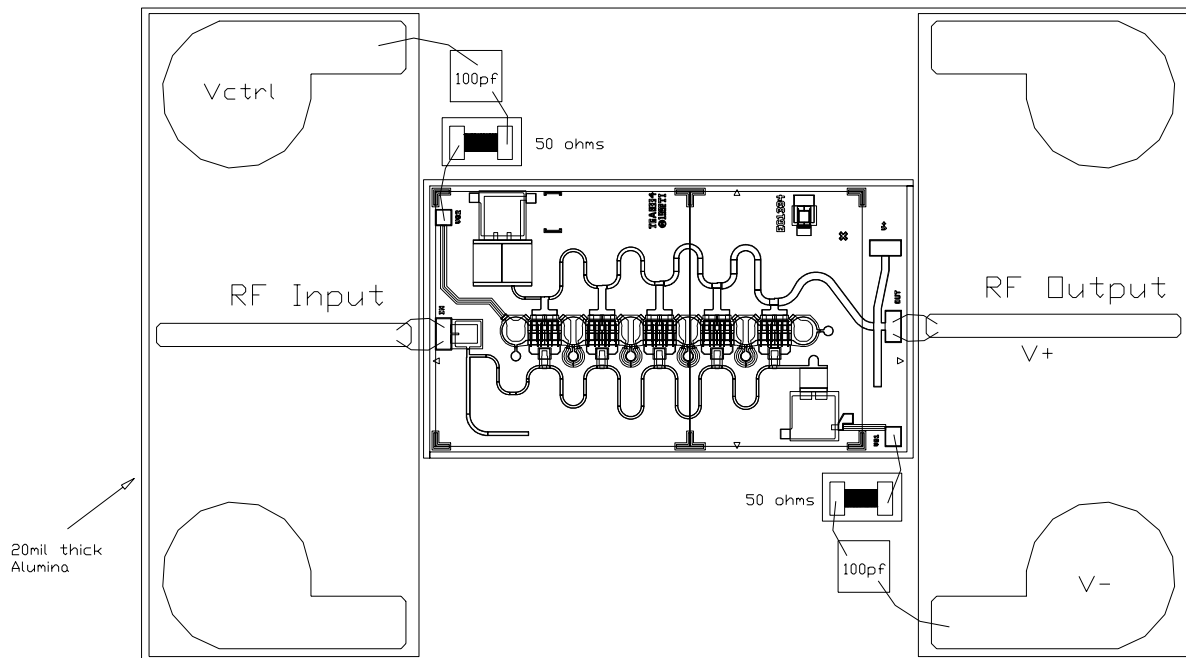

RF connections: Bond using two 1.0-mil diameter, 20 to 25-mil-length gold bondwires at both RF Input and RF Output.

DC blocks required at RF Output port.

Close placement of external components is essential to stability.

Refer to TriQuint Semiconductor Gallium Arsenide Products Designers' Information on website or order literature number GMNA002.

GaAs MMIC devices are susceptible to damage from Electrostatic Discharge. Proper precautions should be observed during handling, assembly and test.

**MECHANICAL
DRAWING**

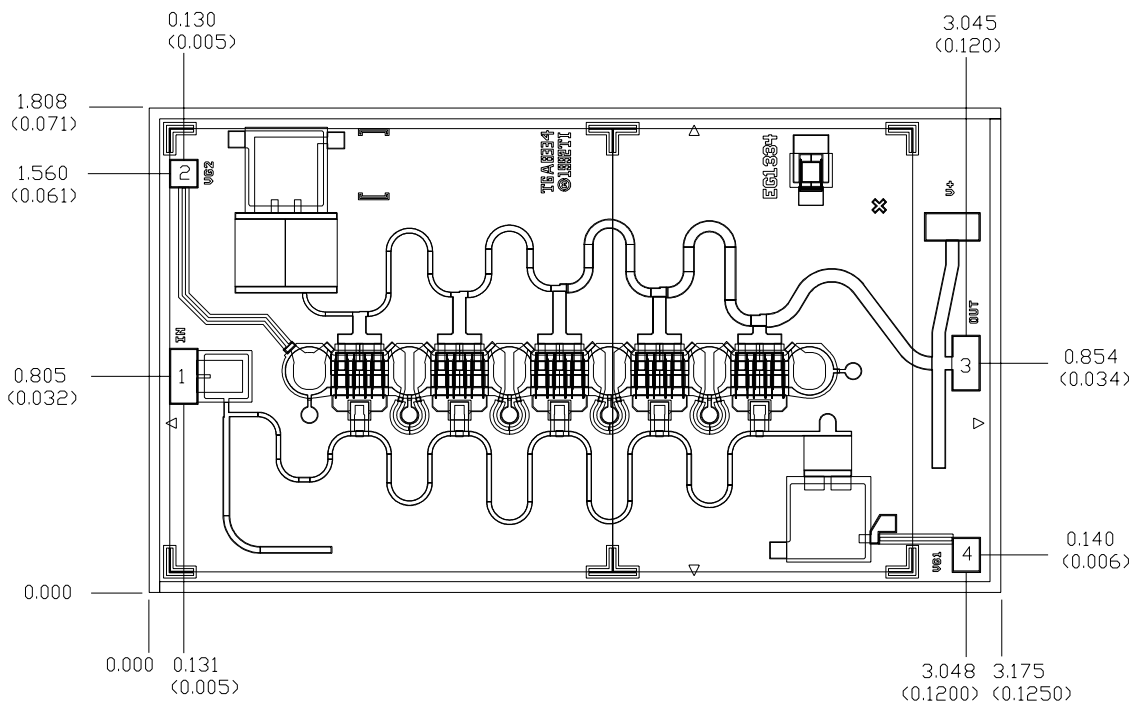

Units: millimeters (inches)
 Thickness: 0.1524 (0.006) (reference only)
 Chip edge to bond pad dimensions are shown to center of bond pad
 Chip size tolerance: +/- 0.051 (0.002)

RF GND IS BACKSIDE OF MMIC

Bond Pad #1 (RF Input)	0.097 x 0.198 (0.004 x 0.008)
Bond Pad #2 (Vctrl)	0.097 x 0.097 (0.004 x 0.004)
Bond Pad #3 (RF Output/V+)	0.097 x 0.198 (0.004 x 0.008)
Bond Pad #4 (V-)	0.097 x 0.121 (0.004 x 0.005)

GaAs MMIC devices are susceptible to damage from Electrostatic Discharge. Proper precautions should be observed during handling, assembly and test.

Recommended Maximum Input Power for TGA8334-SCC MMICs

Background: TriQuint Semiconductor Texas has conducted tests to determine the maximum input power that can be applied to MESFET MMICs. In many applications, devices may be subjected to higher input powers than the recommended normal operating conditions. It is understood that applications at greater than recommended input power may lead to degradation of device performance.

Method: Tests were performed on samples of the TGA8334 to determine a safe operating level of input power.

An acceptable operating condition for input power is defined as a change of <10% in I_d or a change of <1dB in gain

Tests were performed for 24 hours each. Both RF device characteristics were measured before and after the devices were subjected to high input power conditions. An input power that degraded any of the above parameters in excess of the stated allowable changes in performance was considered to be an unacceptable condition. Figure 1 below illustrates the test sequence.

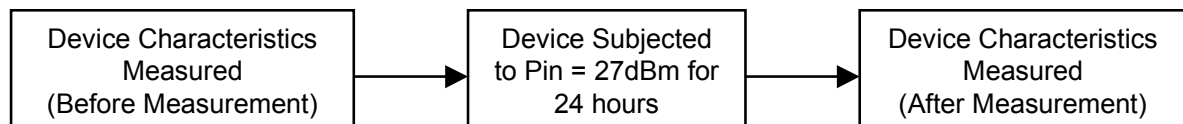

Figure 1 -- Device Test Flow Diagram

Results: Table 1 summarizes the DC and RF performance of the TGA8334 samples after being subjected to an input power of 27dBm for 24 hrs. All parameters remained within the acceptable degradation range. The maximum input power value that is listed on each TriQuint data sheet, reflects the acceptable input power level that may be applied without degradation in excess of that listed above.

It should be noted that device MTTF may be affected by long term exposure to high input power levels. Devices operated at or near maximum value for long periods of time may experience degraded performance or failure.

	Delta Spec Change		
	Sample 1	Sample 2	Sample 3
Gain (dB)	0.09	0.03	0.01
Id (%)	0	5.7	5.7

Table I – Typical Test Results of TGA8334 with Pin=27dBm

An acceptable operating condition for input power is defined as a change of <10% in Id or a change of <1dB in gain

Table 1 illustrates that the TGA8334 devices are capable of handling 27dBm input signals for extended periods with only small degradation to RF and DC performance parameters. The mean value for catastrophic failure is near 39dBm.

For additional information, please contact TriQuint Texas Applications Engineering Department at 972-994-3647.