



MAXIM W-CDMA LNA/Mixer ICs

MAX2387/MAX2388/MAX2389

General Description

The MAX2387/MAX2388/MAX2389 low-noise amplifier (LNA), downconverter mixers designed for W-CDMA applications, are ideal for ARIB (Japan) and ETSI-UMTS (Europe) based systems. The MAX2387/MAX2388/MAX2389 feature ultra-low current consumption and exceptionally low noise figures in ultra-small packages.

The MAX2387/MAX2388 include an LNA, a downconverter mixer, and a local-oscillator (LO) buffer. The MAX2389 has an LNA and mixer, but minimizes current consumption by omitting the LO buffer. For all devices, the LNA and downconverter mixers are optimized for the 2110MHz to 2170MHz band. All devices feature a high-gain mode and a low-gain mode of LNA operation. The MAX2387 has a 32dB gain step, and the MAX2388/MAX2389 have an 18dB gain step. All ICs include a shutdown mode, powering down the IC during the front-end receiver's idle periods.

The mixer 3rd-order nonlinearity performance is set using an external biasing resistor. For the MAX2387/MAX2388, mixer performance is optimized for a -10dBm typical drive at the LO buffer input port. The MAX2389 mixer performance is optimized for a -4dBm typical drive at the LO input port. The LO port for all versions is configurable for either single-ended or differential operation.

These devices operate from a +2.7V to +3.3V single supply and are available in ultra-small (3mm x 3mm) 12-pin leadless packages (QFN).

Applications

- Japanese 3rd-Generation W-CDMA Cellular Phones
- Dual-Mode W-CDMA/GSM Cellular Phones

Features

- ◆ Ultra-Low Current Consumption: 10.7mA (MAX2387), 9.9mA (MAX2388), and 7.9mA (MAX2389)
- ◆ +2.7V to +3.3V Single-Supply Operation
- ◆ Mixer NF: 7dB SSB
- ◆ Cascaded Noise Figure: 2.3dB
- ◆ LNA Low-Gain Mode: 32dB Gain Step (MAX2387) or 18dB Gain Step (MAX2388/MAX2389)
- ◆ Mixer IIP3: 6dBm
- ◆ < 1µA Shutdown Current
- ◆ Ultra-Small (3mm x 3mm) 12-Pin QFN Package

Ordering Information

| PART | TEMP. RANGE | PIN-PACKAGE |
|------------|----------------|-------------|
| MAX2387EGC | -40°C to +85°C | 12 QFN |
| MAX2388EGC | -40°C to +85°C | 12 QFN |
| MAX2389EGC | -40°C to +85°C | 12 QFN |

Pin Descriptions/Functional Diagrams

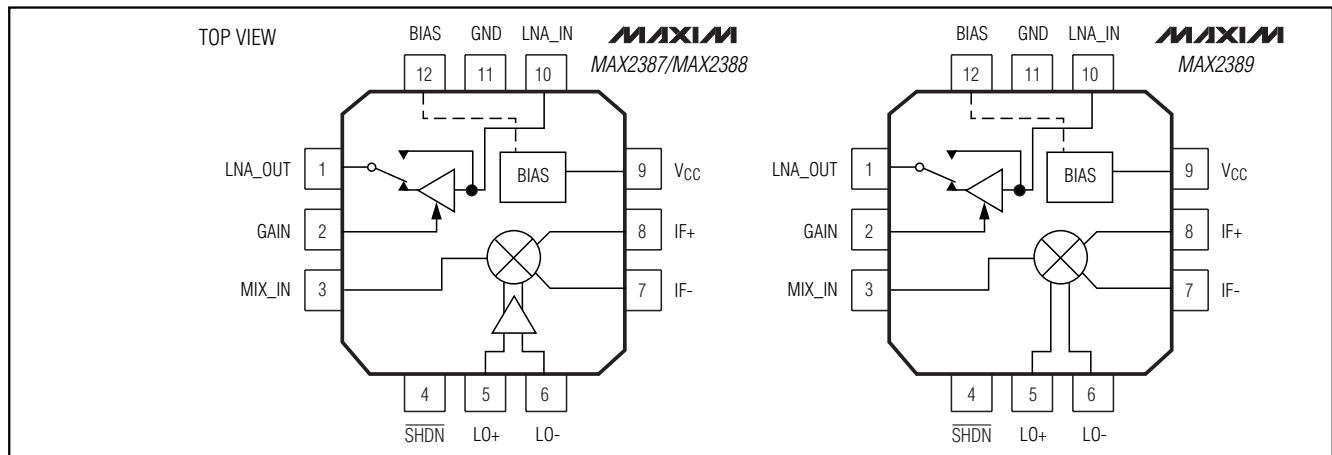

For pricing, delivery, and ordering information, please contact Maxim/Dallas Direct! at 1-888-629-4642, or visit Maxim's website at www.maxim-ic.com.

W-CDMA LNA/Mixer ICs

ABSOLUTE MAXIMUM RATINGS

V_{CC} to GND-0.3V to +4.3V
 SHDN, GAIN to GND-0.3V to (V_{CC} + 0.3V)
 AC Signals+1V peak
 Digital Input Current±10mA
 Continuous Power Dissipation (T_A = +70°C)
 12-Pin QFN (derate 11.9mW/°C above T_A = +70°C)...952mW

Operating Temperature Range-40°C to +85°C
 Junction Temperature+150°C
 Storage Temperature Range-65°C to +150°C
 Soldering Temperature (10s).....+300°C

Stresses beyond those listed under "Absolute Maximum Ratings" may cause permanent damage to the device. These are stress ratings only, and functional operation of the device at these or any other conditions beyond those indicated in the operational sections of the specifications is not implied. Exposure to absolute maximum rating conditions for extended periods may affect device reliability.

DC ELECTRICAL CHARACTERISTICS

(V_{CC} = +2.7V to +3.3V, SHDN = high, R_{BIAS} = 24kΩ, no input AC signals, T_A = -40°C to +85°C. Typical values are at V_{CC} = +2.7V, T_A = +25°C, unless otherwise noted.)

| PARAMETER | SYMBOL | CONDITIONS | MIN | TYP | MAX | UNITS |
|--------------------------|-----------------|-----------------------------------|---------|------|------|-------|
| Operating Supply Current | I _{CC} | High-gain mode | MAX2387 | 10.7 | 12.4 | mA |
| | | | MAX2388 | 9.9 | 11.7 | |
| | | | MAX2389 | 7.9 | 9.3 | |
| | | Low-gain mode | MAX2387 | 7.2 | 8.7 | |
| | | | MAX2388 | 6.7 | 8.1 | |
| | | | MAX2389 | 4.7 | 5.7 | |
| Shutdown Supply Current | I _{CC} | SHDN = low | | 0.2 | 1.0 | μA |
| Digital Input Logic High | V _{IH} | | 2.0 | | | V |
| Digital Input Logic Low | V _{IL} | | | | 0.6 | V |
| Input Logic High Current | I _{IH} | V _{IN} = V _{IH} | | | 1 | μA |
| Input Logic Low Current | I _{IL} | V _{IN} = V _{IL} | -20 | | | μA |

AC ELECTRICAL CHARACTERISTICS

(MAX238_ EV kit, V_{CC} = 2.7V, SHDN = high, f_{RF_IN} = f_{LNA_IN} = 2140MHz, f_{LO} = 2330MHz (f_{IF} = 190MHz). Mixer, LNA, and LO input ports are driven with 50Ω sources. R_{BIAS} = 24kΩ ±1%, P_{LO} = -10dBm (MAX2387/MAX2388), P_{LO} = -4dBm (MAX2389), P_{RF} = -30dBm. Typical values are at V_{CC} = +2.7V, T_A = +25°C, unless otherwise noted.)

| PARAMETER | SYMBOL | CONDITIONS | MIN | TYP | MAX | UNITS |
|---|------------------|--|------|-----|------|-------|
| LNA PERFORMANCE: LOW-GAIN MODE (GAIN = HIGH) | | | | | | |
| RF Frequency Range (Note 1) | f _{RF} | | 2110 | | 2170 | MHz |
| Gain | G _{LNA} | T _A = +25°C | 13.5 | 15 | 16.5 | dB |
| | | T _A = -40°C to +85°C (Note 2) | 12.9 | | 17.0 | |

W-CDMA LNA/Mixer ICs

MAX2387/MAX2388/MAX2389

AC ELECTRICAL CHARACTERISTICS (continued)

(MAX238_EV kit, $V_{CC} = 2.7V$, $\overline{SHDN} = \text{high}$, $f_{RF_IN} = f_{LNA_IN} = 2140\text{MHz}$, $f_{LO} = 2330\text{MHz}$ ($f_{IF} = 190\text{MHz}$). Mixer, LNA, and LO input ports are driven with 50Ω sources. $R_{BIAS} = 24k\Omega \pm 1\%$, $P_{LO} = -10\text{dBm}$ (MAX2387/MAX2388), $P_{LO} = -4\text{dBm}$ (MAX2389), $P_{RF} = -30\text{dBm}$. Typical values are at $V_{CC} = +2.7V$, $T_A = +25^\circ\text{C}$, unless otherwise noted.)

| PARAMETER | SYMBOL | CONDITIONS | MIN | TYP | MAX | UNITS | |
|--|--------------|--|---------------------|-------|-------|-------|-----|
| Noise Figure (Notes 1, 3) | N_{FLNA} | $T_A = +25^\circ\text{C}$ | | 1.7 | 2.2 | dB | |
| 3rd-Order Input Intercept Point (Note 4) | $IIP3_{LNA}$ | $T_A = -40^\circ\text{C}$ to $+85^\circ\text{C}$ (Note 2) | | 4.2 | | dBm | |
| Input -1dB Compression Point (Note 1) | IP-1dB | | -19 | -13 | | dBm | |
| LNA PERFORMANCE: LOW-GAIN MODE (GAIN = LOW) | | | | | | | |
| Gain | G_{LNA} | $T_A = +25^\circ\text{C}$ | MAX2387 | -18.5 | -16.5 | -14.5 | dB |
| | | | MAX2388/ MAX2389 | -4.7 | -2.8 | -0.9 | |
| | | $T_A = -40^\circ\text{C}$ to $+85^\circ\text{C}$ (Note 2) | MAX2387 | -10.5 | | -14 | |
| | | | MAX2388/ MAX2389 | 5.4 | | -0.7 | |
| Noise Figure (Notes 1, 3) | N_{FLNA} | | MAX2387 | | 19.2 | 21.3 | dB |
| | | | MAX2388/ MAX2389 | | 6.5 | 8.4 | |
| 3rd-Order Input Intercept Point (Note 5) | $IIP3_{LNA}$ | | MAX2387 | | 1 | | dBm |
| | | | MAX2388/ MAX2389 | | 3.4 | | |
| Input -1dB Compression Point | IP-1dB | | MAX2387 | | -9.9 | | dBm |
| | | | MAX2388/ MAX2389 | | -7.7 | | |
| MIXER PERFORMANCE (GAIN = HIGH) | | | | | | | |
| RF Frequency Range (Note 1) | f_{RF} | | 2110 | | 2170 | MHz | |
| LO Frequency Range (Note 1) | f_{LO} | | 2250 | | 2600 | MHz | |
| IF Frequency Range (Note 1) | f_{IF} | | 150 | | 400 | MHz | |
| Power Conversion Gain | G_{MXR} | $T_A = +25^\circ\text{C}$ | | 8.5 | 10 | 11.5 | dB |
| | | $T_A = -40^\circ\text{C}$ to $+85^\circ\text{C}$ (Note 2) | | 7.5 | | 12.5 | |
| Noise Figure (SSB) (Note 1) | N_{FMXR} | $T_A = +25^\circ\text{C}$ | MAX2387 | | 7.2 | 8.8 | dB |
| | | | MAX2388 | | 6.8 | 8.2 | |
| | | | MAX2389 | | 7.3 | 9.5 | |

W-CDMA LNA/Mixer ICs

MAX2387/MAX2388/MAX2389

AC ELECTRICAL CHARACTERISTICS (continued)

(MAX238_EV kit, $V_{CC} = 2.7V$, $\overline{SHDN} = \text{high}$, $f_{RF_IN} = f_{LNA_IN} = 2140\text{MHz}$, $f_{LO} = 2330\text{MHz}$ ($f_{IF} = 190\text{MHz}$). Mixer, LNA, and LO input ports are driven with 50Ω sources. $R_{BIAS} = 24k\Omega \pm 1\%$, $P_{LO} = -10\text{dBm}$ (MAX2387/MAX2388), $P_{LO} = -4\text{dBm}$ (MAX2389), $P_{RF} = -30\text{dBm}$. Typical values are at $V_{CC} = +2.7V$, $T_A = +25^\circ\text{C}$, unless otherwise noted.)

| PARAMETER | SYMBOL | CONDITIONS | MIN | TYP | MAX | UNITS |
|--|-----------------------|---|---------|-------|-------|-------|
| 3rd-Order Input Intercept Point (Notes 1, 3) | IIP3 _{MXR} | | MAX2387 | 6 | | dBm |
| | | | MAX2388 | 6 | | |
| | | | MAX2389 | 5 | | |
| Input -1dB Compression Point (Note 1) | IP-1dB _{MXR} | $T_A = -40^\circ\text{C to } +85^\circ\text{C}$ | MAX2387 | -13.9 | -10 | dBm |
| | | | MAX2388 | -16.3 | -10.5 | |
| | | | MAX2389 | -15.4 | -10.5 | |
| MIXER PERFORMANCE (GAIN = LOW) | | | | | | |
| Power Conversion Gain (Note 1) | GMXR | $T_A = +25^\circ\text{C}$ | 7.5 | 9.0 | 10.5 | dB |
| | | $T_A = -40^\circ\text{C to } +85^\circ\text{C}$ | 6.5 | | 12.0 | |
| Noise Figure (SSB) (Note 1) | NF _{MXR} | $T_A = +25^\circ\text{C}$ | MAX2387 | 6.9 | 8.4 | dB |
| | | | MAX2388 | 6.1 | 7.4 | |
| | | | MAX2389 | 6.6 | 8.8 | |
| 3rd-Order Input Intercept Point (Note 4) | IIP3 _{MXR} | $T_A = +25^\circ\text{C}$ | MAX2387 | 0.7 | | dBm |
| | | | MAX2388 | 0.2 | | |
| | | | MAX2389 | 1.3 | | |
| Input -1dB Compression Point (Note 1) | IP-1dB _{MXR} | $T_A = -40^\circ\text{C to } +85^\circ\text{C}$ | MAX2387 | -15.0 | -10.7 | dBm |
| | | | MAX2388 | -18.2 | -11.3 | |
| | | | MAX2389 | -17.8 | -11.9 | |

Note 1: Guaranteed by design and characterization.

Note 2: MIN guaranteed by production test, MAX guaranteed by design and characterization.

Note 3: Includes input matching circuit loss.

Note 4: $f_{IN1} = 2140\text{MHz}$, $f_{IN2} = 2141\text{MHz}$, $P_{IN} = -30\text{dBm}$ per tone.

Note 5: $f_{IN1} = 2140\text{MHz}$, $f_{IN2} = 2141\text{MHz}$, $P_{IN} = -25\text{dBm}$ per tone.

W-CDMA LNA/Mixer ICs

Typical Operating Characteristics

($T_A = +25^\circ\text{C}$, $V_{CC} = +2.7\text{V}$, unless otherwise noted.)

MAX2387/MAX2388/MAX2389

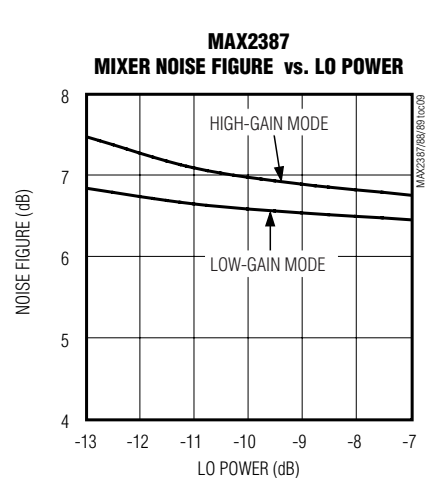
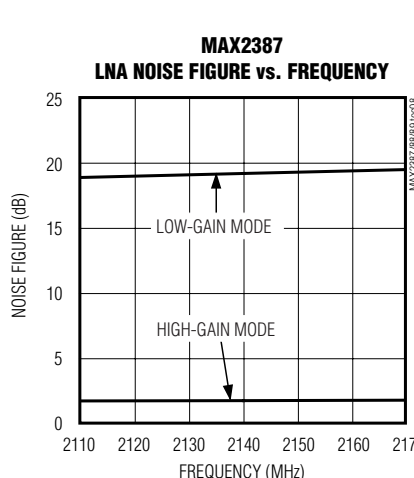
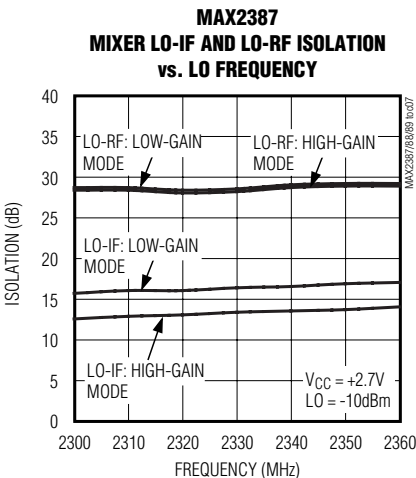
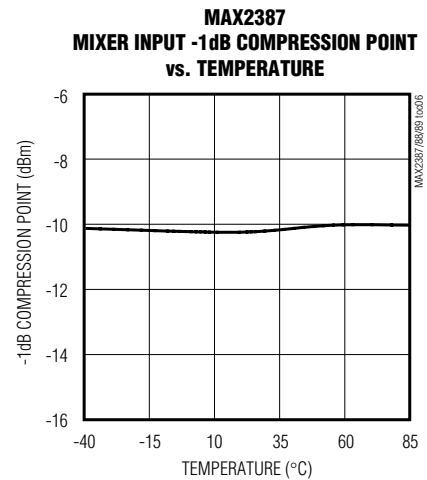
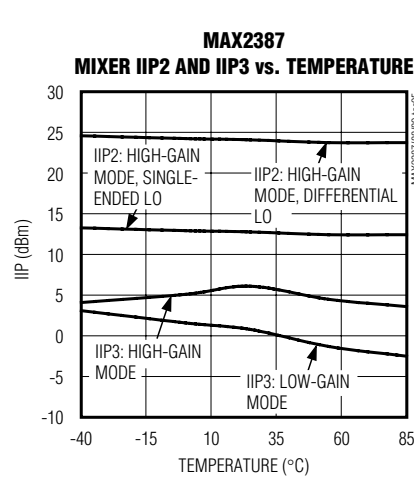
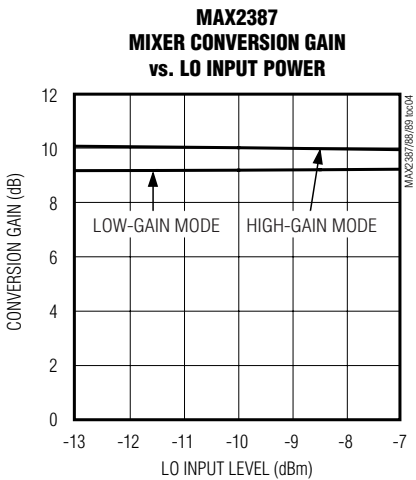
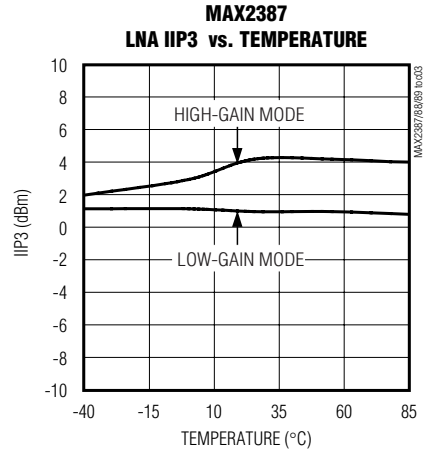
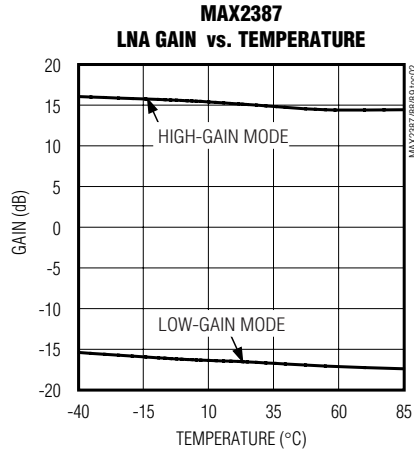
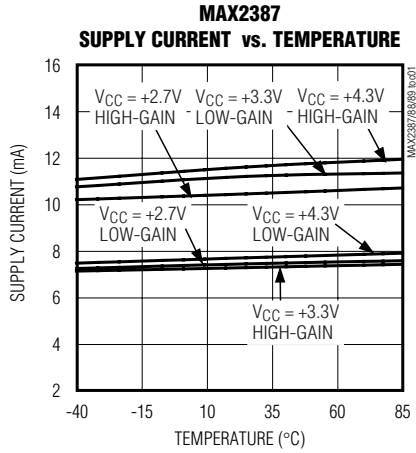

W-CDMA LNA/Mixer ICs

Typical Operating Characteristics (continued)

($T_A = +25^\circ\text{C}$, $V_{CC} = +2.7\text{V}$, unless otherwise noted.)

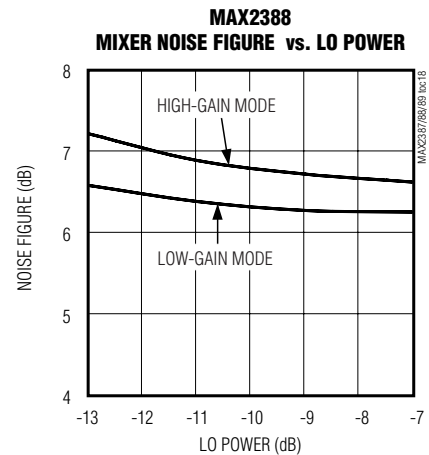
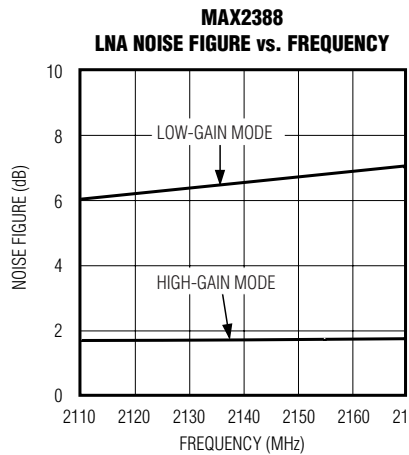
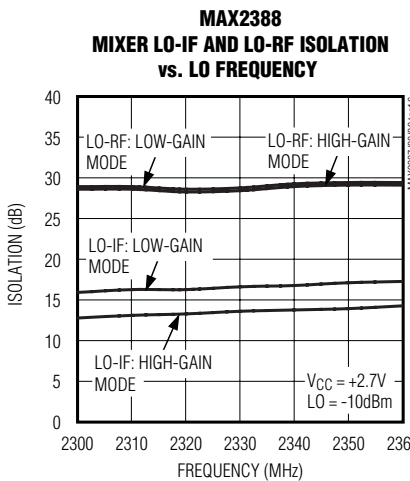
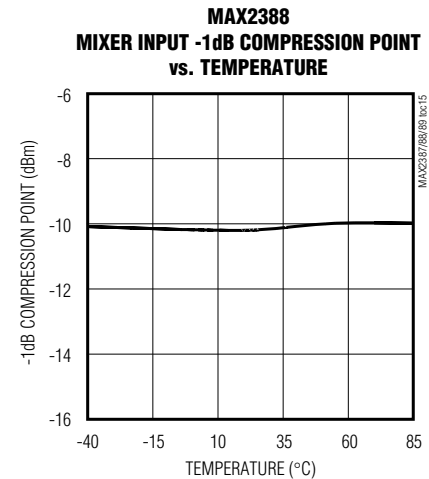
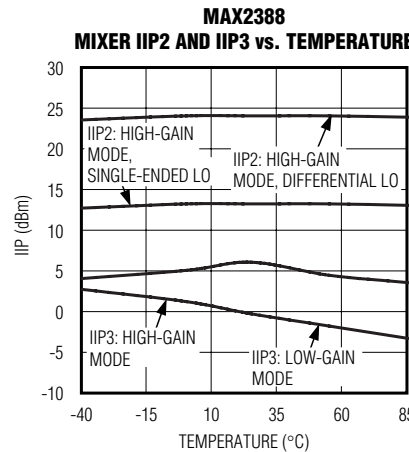
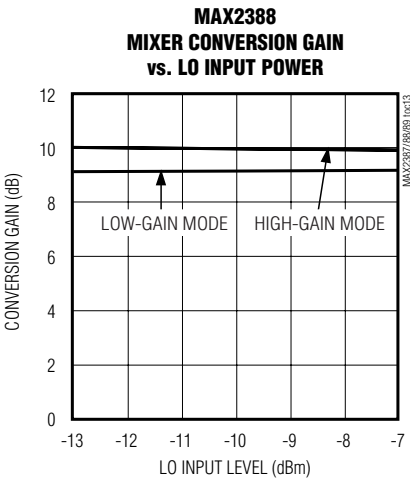
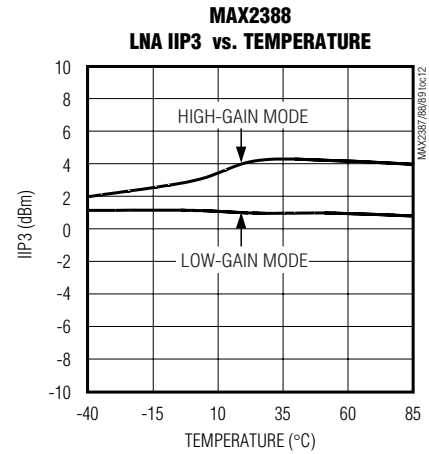
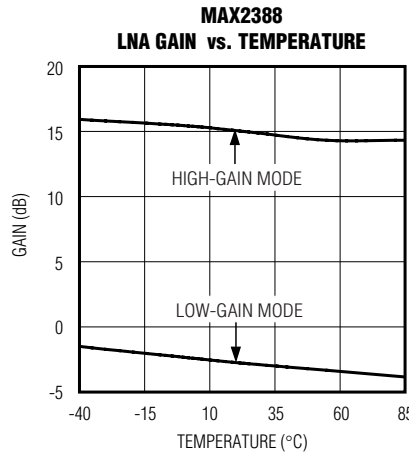
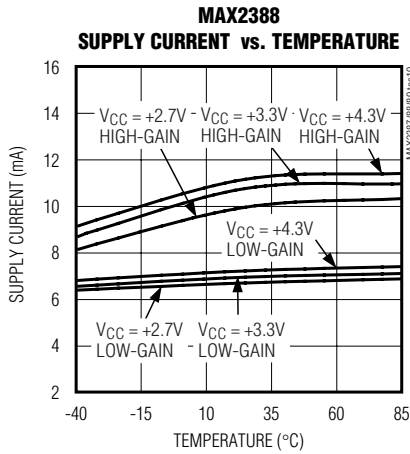

W-CDMA LNA/Mixer ICs

Typical Operating Characteristics (continued)

($T_A = +25^\circ\text{C}$, $V_{CC} = +2.7\text{V}$, unless otherwise noted.)

MAX2387/MAX2388/MAX2389

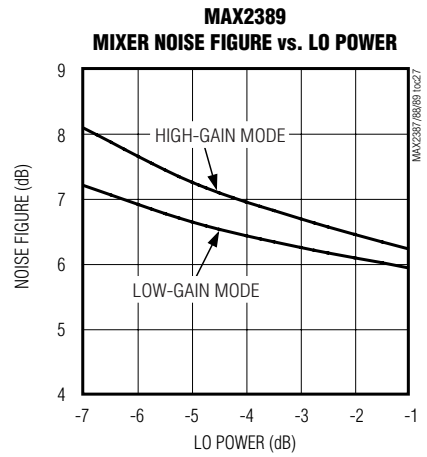
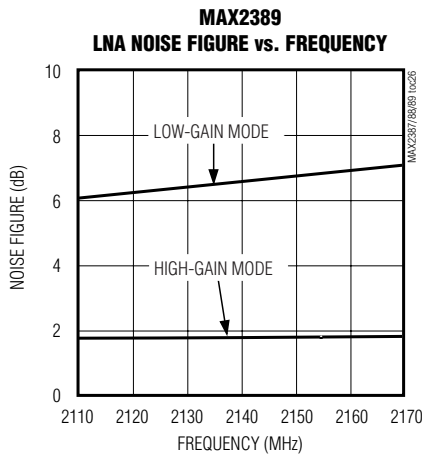
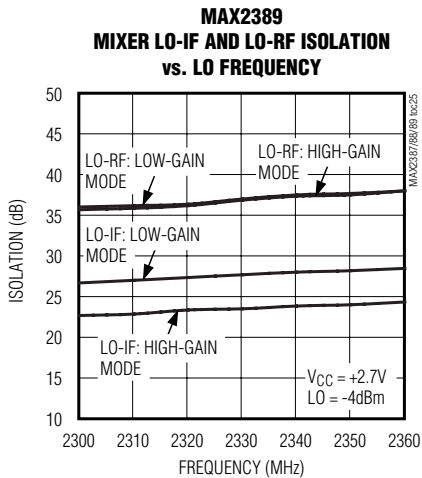
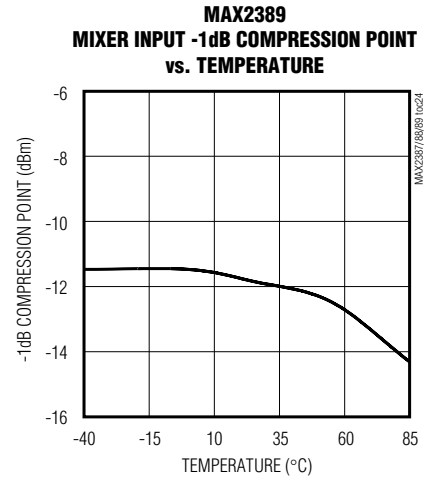
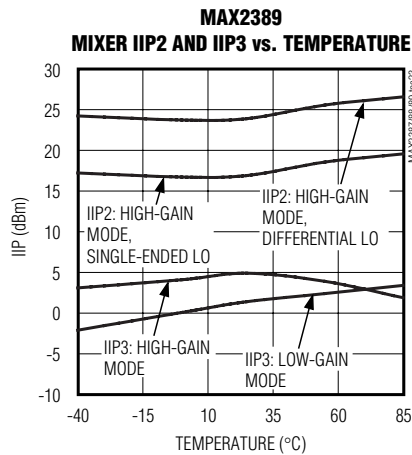
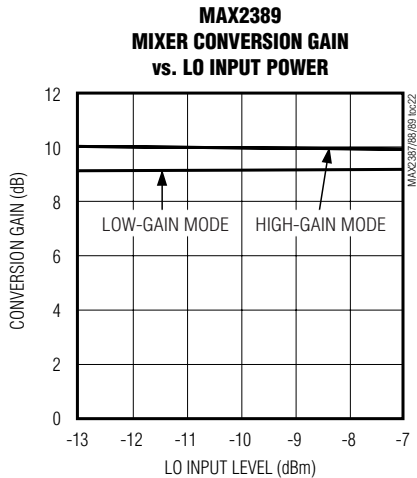
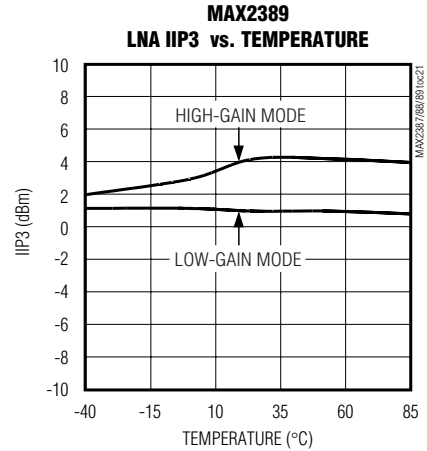
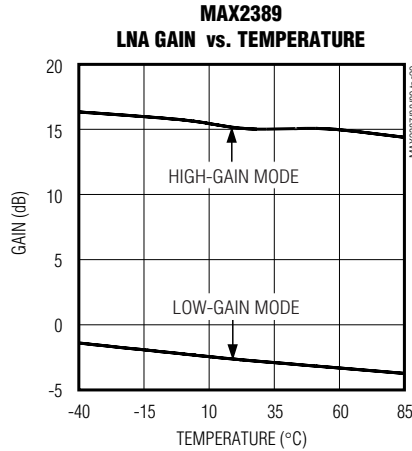
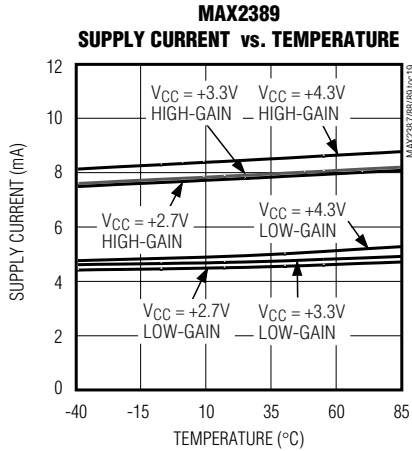

W-CDMA LNA/Mixer ICs

Pin Description

| PIN | NAME | FUNCTION |
|-----|--------------------------|--|
| 1 | LNA_OUT | RF Output Port for LNA. Requires external matching. |
| 2 | GAIN | LNA/Mixer Gain Control Input |
| 3 | MIX_IN | RF Input Port for Mixer. Internally matched to 50Ω. |
| 4 | $\overline{\text{SHDN}}$ | Shutdown Input. Drive low to enable shutdown mode. Drive high or connect to V _{CC} for normal operation. |
| 5 | LO+ | Noninverting LO Input for LO Buffer (MAX2387/MAX2388) or Mixer (MAX2389). Differential input impedance is 200Ω. AC-couple to GND when the LO is driven single-endedly. |
| 6 | LO- | Inverting LO Input for LO Buffer (MAX2387/MAX2388) or Mixer (MAX2389). Differential input impedance is 200Ω. |
| 7 | IF- | Inverting Mixer's IF Open-Collector Output |
| 8 | IF+ | Noninverting Mixer's IF Open-Collector Output |
| 9 | V _{CC} | Supply Voltage (+2.7V to +3.3V). Capacitively bypass to GND near the IC. |
| 10 | LNA_IN | RF Input Port for LNA. Requires external matching. |
| 11 | GND | Ground |
| 12 | BIAS | LNA/Mixer Bias Pin. For nominal bias, connect 24kΩ ±1% resistor to GND. |

Detailed Description

The MAX2387/MAX2388/MAX2389 include an LNA and downconverter mixer. These devices feature a shutdown mode to power down the IC during the front-end receiver's idle periods. Each IC operates from a +2.7V to +3.3V single supply and is housed in a 12-pin ultra-small QFN (3mm × 3mm) leadless package.

The MAX2387/MAX2388/MAX2389 are fabricated using an advanced high-frequency silicon germanium process. The LNA and mixer NF and IIP3 have been optimized to provide excellent RF performance in the 2110MHz to 2170MHz band, while drawing minimal current.

For the MAX2387/MAX2388, the mixer's performance is optimized for a -10dBm typical drive at the LO buffer input port. The MAX2389's mixer performance is optimized for a -4dBm typical drive at the LO input port. The LO port for all versions can be driven either single-ended or differentially.

LNA High/Low-Gain Mode

These devices offer two modes of operation for the LNA: high-gain mode and low-gain mode, selectable with a GAIN select pin. The MAX2387 has a gain of 15dB in high-gain mode and -16.6dB in low-gain mode. The MAX2388/MAX2389 have a gain of 15dB in high-gain mode and -2.8dB in low-gain mode. Matching LNA in high-gain mode will ensure matching in low-gain mode.

Downconverter Mixer

The receive mixer is a wideband, single-balanced design with exceptional noise figure and linearity. The LO input frequency range is 2330MHz to 2360MHz and the RF input frequency range is 2110MHz to 2170MHz. The mixer is internally matched to 50Ω, thus eliminating any external matching components.

LO Input Buffers

The MAX2387/MAX2388 feature open-collector LO buffers to increase isolation between the LO and the rest of the system. The MAX2389 offers a lower current consumption for applications that do not require an LO buffer.

RF Inputs

The MIX_IN input is typically connected to the LNA output through an off-chip filter providing image rejection and out-of-band interferers filtering. The LNA input and output require an external matching network to 50Ω. Note that the mixer input is internally matched to 50Ω. See Figure 1, *Typical Application Circuits* for 2.14GHz.

LO Inputs

The LO+ and LO- pins are internally terminated with 100Ω resistors. AC-couple the local-oscillator signal to these pins. If a single-ended LO source is used, connect LO+ to ground using an AC-coupling capacitor.

W-CDMA LNA/Mixer ICs

IF Output Port

The mixer output appears on the differential IF+ and IF- pins. These open-collector outputs require an external inductor to V_{CC} for DC biasing. This port typically requires a matching network for coupling to an external IF filter. Figures 1 and 2 show examples of differential and single-ended IF port connections.

Applications Information

Layout

A properly designed PC board is essential to any RF/microwave circuit. Keep RF signal lines as short as possible to minimize losses and radiation. Always use controlled impedance lines on all high-frequency inputs and outputs and use low-inductance connections to ground on all GND pins. At the mixer outputs, keep the differential lines together and of the same length to ensure signal balance.

For the best gain and noise performance, use high-quality components for the LNA input matching circuit, and solder the slug evenly to the board ground plane.

For the power supplies, a star topology works well to isolate between different sections of the device. Each V_{CC} node has its own path to a central V_{CC}. Place decoupling capacitors that provide low impedance at the RF frequency of interest close to all V_{CC} connections. The central V_{CC} should have a large decoupling capacitor as well. (Use MAX2387/MAX2388/MAX2389 EV kit as an example.)

Chip Information

TRANSISTOR COUNT: 208

Typical Application Circuits

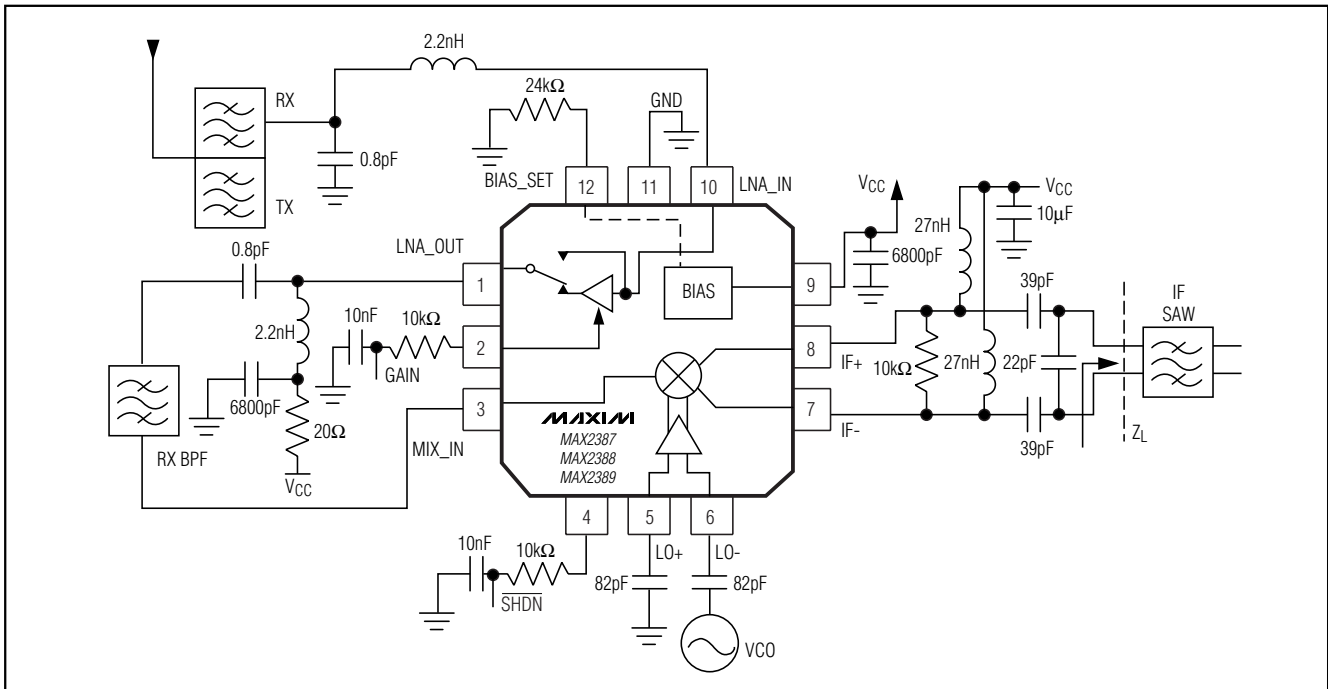

Figure 1. MAX2387/MAX2388/MAX2389 Differential IF Load; Single-Ended VCO

W-CDMA LNA/Mixer ICs

MAX2387/MAX2388/MAX2389

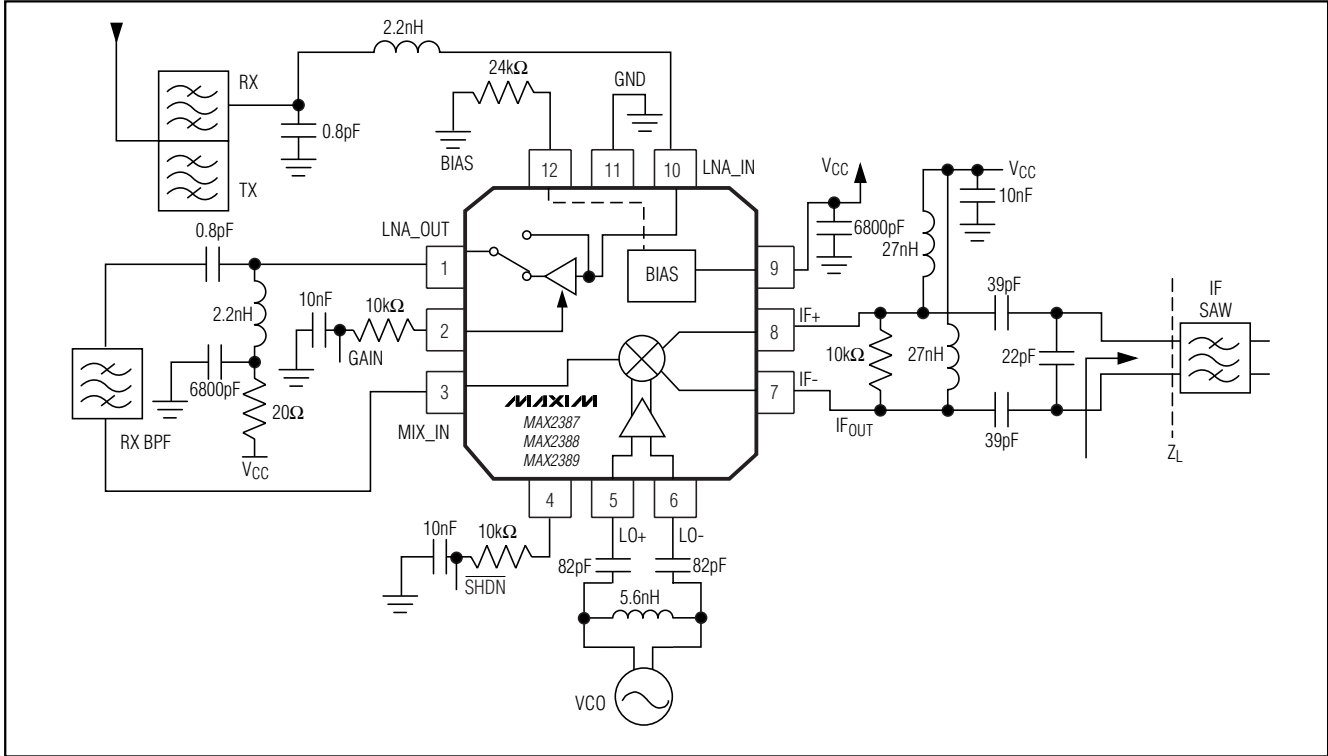

Figure 2. MAX2387/MAX2388/MAX2389 Differential IF Load; Differential VCO

W-CDMA LNA/Mixer ICs

MAX2387/MAX2388/MAX2389

Table 1. LNA Input/Output S-Parameters (VCC = +2.7V, High-Gain Mode)

| S-PARAMETERS | LNA (S11) | | LNA (S21) | | LNA (S12) | | LNA (S22) | |
|--------------|-----------------|-----------|-----------|-----------|-----------|-----------|-----------|-----------|
| | FREQUENCY (MHZ) | MAGNITUDE | PHASE | MAGNITUDE | PHASE | MAGNITUDE | PHASE | MAGNITUDE |
| 600 | 0.83287 | -41.655 | 5.2176 | 146.82 | 0.020023 | 79.051 | 0.92461 | -15.535 |
| 700 | 0.81889 | -43.792 | 5.0791 | 145.33 | 0.021153 | 78.88 | 0.9171 | -16.23 |
| 800 | 0.80364 | -46.486 | 4.9464 | 143.26 | 0.022406 | 78.412 | 0.91098 | -17.187 |
| 900 | 0.78522 | -49.489 | 4.7767 | 141.09 | 0.023962 | 79.181 | 0.90108 | -18.177 |
| 1000 | 0.76638 | -53.118 | 4.6109 | 138.2 | 0.025913 | 78.989 | 0.8914 | -19.536 |
| 1100 | 0.74542 | -56.424 | 4.4363 | 135.68 | 0.027189 | 79.621 | 0.87913 | -20.759 |
| 1200 | 0.72614 | -59.477 | 4.2861 | 133.2 | 0.028484 | 79.666 | 0.86957 | -22.045 |
| 1300 | 0.70338 | -62.232 | 4.1209 | 130.93 | 0.030015 | 80.686 | 0.85623 | -23.156 |
| 1400 | 0.68291 | -64.933 | 4.0146 | 128.4 | 0.030979 | 81.41 | 0.84504 | -24.46 |
| 1500 | 0.66114 | -67.298 | 3.8951 | 126.82 | 0.032236 | 82.856 | 0.83313 | -25.525 |
| 1600 | 0.63958 | -69.782 | 3.7818 | 124.53 | 0.033056 | 83.763 | 0.82095 | -26.882 |
| 1700 | 0.61641 | -72.041 | 3.6761 | 122.88 | 0.03398 | 85.56 | 0.80875 | -28.147 |
| 1800 | 0.59303 | -74.571 | 3.5823 | 120.51 | 0.035009 | 86.377 | 0.79497 | -29.825 |
| 1900 | 0.56989 | -76.974 | 3.5198 | 118.87 | 0.036332 | 88.572 | 0.78338 | -31.503 |
| 2000 | 0.54509 | -79.651 | 3.4376 | 116.77 | 0.036887 | 89.686 | 0.76891 | -33.44 |
| 2100 | 0.52084 | -82.452 | 3.3691 | 115.17 | 0.038318 | 91.409 | 0.75735 | -35.559 |
| 2200 | 0.49554 | -85.891 | 3.2858 | 112.47 | 0.039355 | 93.409 | 0.74365 | -38.175 |
| 2300 | 0.47232 | -89.473 | 3.2544 | 110.28 | 0.040817 | 94.973 | 0.73415 | -41.034 |
| 2400 | 0.44892 | -93.529 | 3.195 | 108.05 | 0.042049 | 97.086 | 0.72262 | -44.165 |
| 2500 | 0.42766 | -98.164 | 3.1347 | 105.62 | 0.043438 | 98.58 | 0.71335 | -47.828 |
| 2600 | 0.40833 | -103.42 | 3.06 | 102.94 | 0.044844 | 100.14 | 0.70474 | -51.733 |
| 2700 | 0.39421 | -109.16 | 2.9818 | 100.13 | 0.046899 | 101.7 | 0.70067 | -56.04 |
| 2800 | 0.38321 | -115.32 | 2.9149 | 96.964 | 0.048389 | 103.31 | 0.69795 | -60.397 |
| 2900 | 0.37608 | -121.52 | 2.821 | 94.462 | 0.049426 | 104.62 | 0.69514 | -64.899 |
| 3000 | 0.37573 | -128.03 | 2.7086 | 91.479 | 0.05079 | 106.39 | 0.69504 | -69.425 |
| 3100 | 0.38123 | -134.23 | 2.5802 | 88.528 | 0.051657 | 108.22 | 0.69915 | -73.798 |
| 3200 | 0.39208 | -139.73 | 2.4696 | 85.584 | 0.053915 | 110.43 | 0.70504 | -77.625 |
| 3300 | 0.40626 | -144.57 | 2.3296 | 83.264 | 0.055483 | 113.29 | 0.71095 | -81.166 |
| 3400 | 0.42512 | -148.8 | 2.2157 | 80.95 | 0.05783 | 115.29 | 0.71819 | -84.4 |
| 3500 | 0.44708 | -152.13 | 2.0519 | 79.588 | 0.060614 | 118.09 | 0.72516 | -87.06 |
| 3600 | 0.47302 | -154.7 | 1.9382 | 77.337 | 0.065129 | 119.23 | 0.73416 | -89.168 |
| 3700 | 0.49849 | -156.57 | 1.8048 | 76.594 | 0.069104 | 120.99 | 0.73997 | -90.676 |

Package Information

For the latest package outline information, go to www.maxim-ic.com/packages.

Maxim cannot assume responsibility for use of any circuitry other than circuitry entirely embodied in a Maxim product. No circuit patent licenses are implied. Maxim reserves the right to change the circuitry and specifications without notice at any time.

Maxim Integrated Products, 120 San Gabriel Drive, Sunnyvale, CA 94086 408-737-7600 _____ 11