

# GPS/GNSS Ultra-Low-Noise-Figure LNAs

## General Description

The MAX2667/MAX2669 high-gain, low-noise amplifiers (LNAs) are designed for GPS L1, Galileo, and GLONASS applications. Designed in Maxim's advanced SiGe process, the devices achieve a high gain and our lowest noise figure, while maximizing the input-referred 1dB compression point and the 3rd-order intercept point.

The devices operate from a +1.6V to +3.3V single supply. The MAX2667 is optimized for low current. The MAX2669 is optimized for high linearity. The shutdown feature in the device reduces the supply current to be less than 10 $\mu$ A. The devices are available in a very small, lead-free, RoHS-compliant, 0.86mm x 1.26mm x 0.65mm wafer-level package (WLP).

## Applications

Automotive Navigation  
Location-Enabled Mobile Devices  
Telematics (Asset Tracking and Management)  
Personal Navigation Devices (PNDs)  
Cellular Phones with GPS  
Notebook PCs/Ultra-Mobile PCs  
Recreational, Marine Navigation  
Avionics  
Watches

## Features

- ◆ 19dB High-Power Gain (MAX2667)
- ◆ Ultra-Low Noise Figure: 0.65dB
- ◆ Integrated 50 $\Omega$  Output Matching Circuit
- ◆ Low 4.1mA Supply Current (MAX2667)
- ◆ Wide 1.6V to 3.3V Supply Voltage Range
- ◆ Low Bill of Materials: Two Inductors, Three Capacitors, and One Resistor
- ◆ Small Footprint: 0.86mm x 1.26mm
- ◆ Thin Profile: 0.65mm
- ◆ 0.4mm-Pitch Wafer-Level Package (WLP)

## Ordering Information

PART	TEMP RANGE	PIN-PACKAGE
MAX2667EWT+T	-40°C to +85°C	6 WLP
MAX2669EWT+T	-40°C to +85°C	6 WLP

+ Denotes a lead(Pb)-free/RoHS-compliant package.  
T = Tape and reel.

## Typical Application Circuit

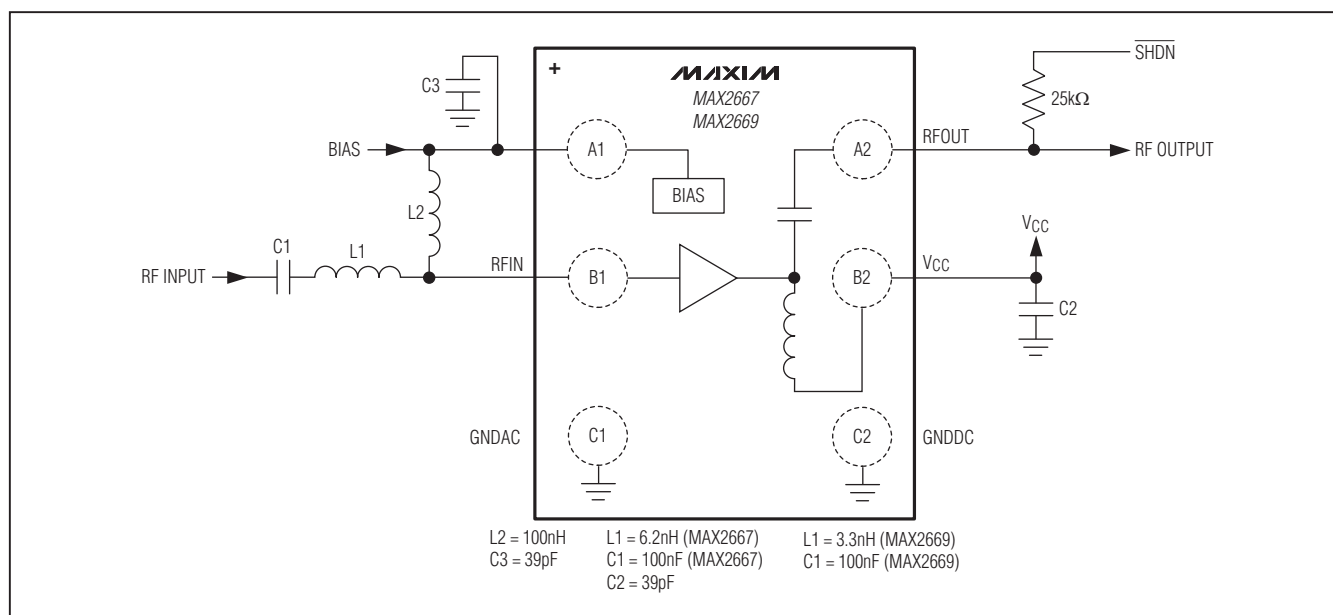

# GPS/GNSS Ultra-Low-Noise-Figure LNAs

## ABSOLUTE MAXIMUM RATINGS

V <sub>CC</sub> to GND <sub>-</sub> .....	-0.3V to +3.6V	Maximum Current into RF Input .....	10mA
RFOUT and BIAS to GND <sub>-</sub> .....	-0.3V to (Operating V <sub>CC</sub> + 0.3V)	Operating Temperature Range .....	-40°C to +85°C
Maximum RF Input Power .....	+5dBm	Junction Temperature .....	+150°C
Continuous Power Dissipation (T <sub>A</sub> = +70°C)		Storage Temperature Range .....	-65°C to +160°C
WLP (derates 10.5mW/°C above +70°C) .....	840mW	Soldering Temperature (reflow) (Note 1) .....	+260°C

**Note 1:** Refer to Application Note 1891: *Wafer-level packaging (WLP) and its applications*.



**CAUTION!** ESD SENSITIVE DEVICE

Stresses beyond those listed under "Absolute Maximum Ratings" may cause permanent damage to the device. These are stress ratings only, and functional operation of the device at these or any other conditions beyond those indicated in the operational sections of the specifications is not implied. Exposure to absolute maximum rating conditions for extended periods may affect device reliability.

## DC ELECTRICAL CHARACTERISTICS

(MAX2667/MAX2669 EV kit. V<sub>CC</sub> = 1.6V to 3.3V, no RF signals are applied, T<sub>A</sub> = -40°C to +85°C. Typical values are at V<sub>CC</sub> = 2.85V and T<sub>A</sub> = +25°C, unless otherwise noted.) (Note 2)

PARAMETER	CONDITIONS	MIN	TYP	MAX	UNITS
Supply Voltage		1.6	2.85	3.3	V
Supply Current	SHDN = high	MAX2667	4.1		mA
		MAX2669	7.7		
	Shutdown mode, SHDN = low			10	μA
Digital Input Logic-High	T <sub>A</sub> = +25°C	1.2			V
Digital Input Logic-Low	T <sub>A</sub> = +25°C			0.45	V

## AC ELECTRICAL CHARACTERISTICS

(MAX2667/MAX2669 EV kit. V<sub>CC</sub> = 1.6V to 3.3V, f<sub>RFIN</sub> = 1575.42MHz, T<sub>A</sub> = -40°C to +85°C. Typical values are at V<sub>CC</sub> = 2.85V and T<sub>A</sub> = +25°C, unless otherwise noted.) (Note 2)

PARAMETER	CONDITIONS	MIN	TYP	MAX	UNITS
RF Frequency	L1 band		1575.42		MHz
Power Gain	V <sub>CC</sub> = 2.85V	MAX2667	15.0	19.5	dB
		MAX2669	14.6	17.7	
	V <sub>CC</sub> = 1.6V	MAX2667	14.8	19.4	
		MAX2669	14.3	17.6	
Noise Figure	V <sub>CC</sub> = 1.8V		0.65		dB
	V <sub>CC</sub> = 3.3V		0.65		
In-Band 3rd-Order Input Intercept Point	(Note 3)	MAX2667	-3.5		dBm
		MAX2669	+4.5		
Out-of-Band 3rd-Order Input Intercept Point	(Note 4)	MAX2667	+2.5		dBm
		MAX2669	+8		
Input 1dB Compression Point	(Note 5)	MAX2667	-12.5		dBm
		MAX2669	-10		
Input Return Loss			10		dB
Output Return Loss			15		dB
Reverse Isolation			30		dB

# GPS/GNSS Ultra-Low-Noise-Figure LNAs

MAX2667/MAX2669

## AC ELECTRICAL CHARACTERISTICS (continued)

(MAX2667/MAX2669 EV kit.  $V_{CC} = 1.6V$  to  $3.3V$ ,  $f_{RFIN} = 1575.42MHz$ ,  $T_A = -40^{\circ}C$  to  $+85^{\circ}C$ . Typical values are at  $V_{CC} = 2.85V$  and  $T_A = +25^{\circ}C$ , unless otherwise noted.) (Note 2)

**Note 2:** Min and max limits guaranteed by test at  $T_A = +25^{\circ}C$  and guaranteed by design and characterization at  $T_A = -40^{\circ}C$  and  $T_A = +85^{\circ}C$ .

**Note 3:** Measured with the two tones located at 1MHz and 2MHz offset from the center of the GPS band with  $-30dBm$ /tone for MAX2667 and  $-27dBm$ /tone for MAX2669.

**Note 4:** Measured with input tones at 1713MHz ( $-25dBm$ ) and 1851MHz ( $-49dBm$ ).

**Note 5:** Measured with a tone located at 5MHz offset from the center of the GPS band.

## Typical Operating Characteristics

(MAX2667/MAX2669 EV kit. Typical values are at  $V_{CC} = 2.85V$ ,  $f_{RFIN} = 1575.42MHz$ ,  $T_A = +25^{\circ}C$ , unless otherwise noted.)

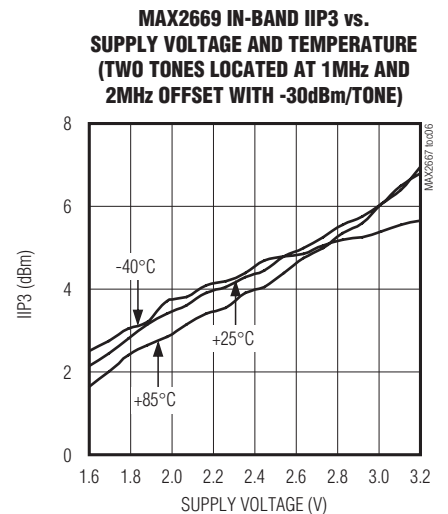
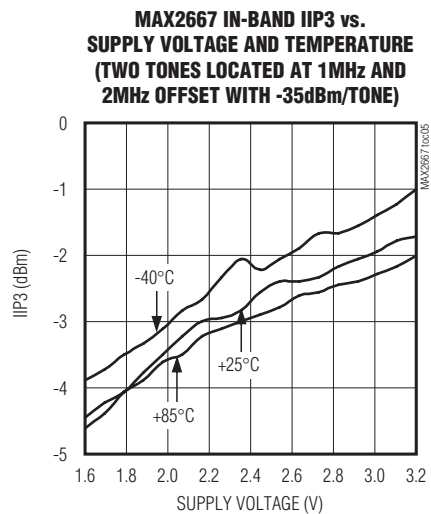
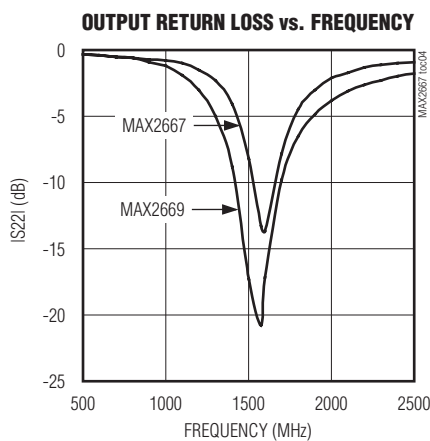
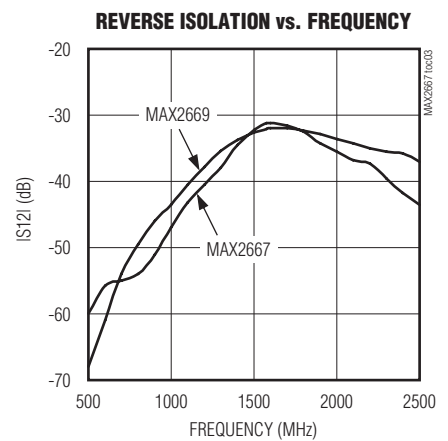
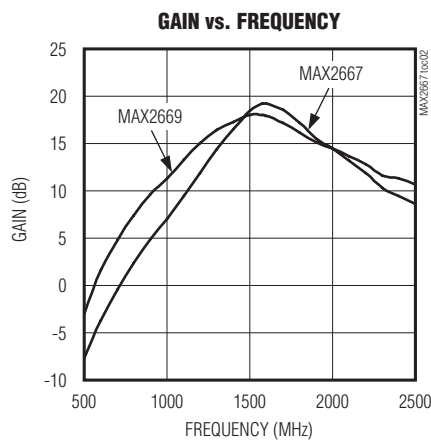
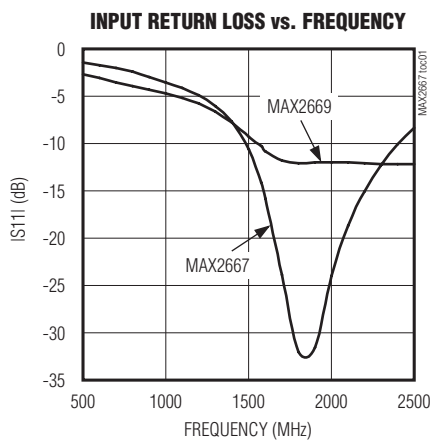

# GPS/GNSS Ultra-Low-Noise-Figure LNAs

## Typical Operating Characteristics (continued)

(MAX2667/MAX2669 EV kit. Typical values are at  $V_{CC} = 2.85V$ ,  $f_{RFIN} = 1575.42MHz$ ,  $T_A = +25^{\circ}C$ , unless otherwise noted.)

**MAX2667 OUT-OF-BAND IIP3 vs. SUPPLY VOLTAGE AND TEMPERATURE**  
(TONE 1 AT 1713MHz, -25dBm;  
TONE 2 AT 1851MHz, -49dBm)

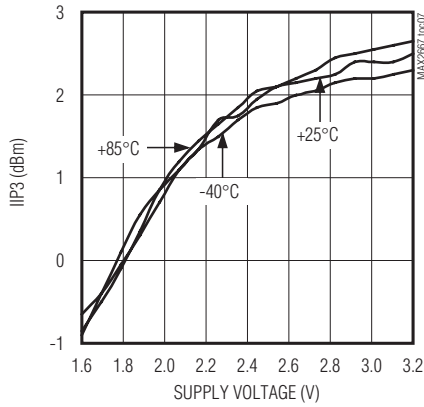

**MAX2669 OUT-OF-BAND IIP3 vs. SUPPLY VOLTAGE AND TEMPERATURE**  
(TONE 1 AT 1713MHz, -25dBm;  
TONE 2 AT 1851MHz, -49dBm)

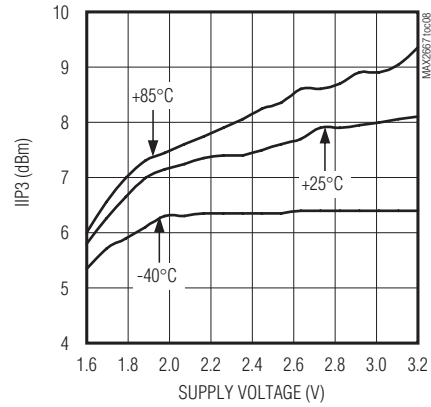

**MAX2667 INPUT P1dB COMPRESSION vs. SUPPLY VOLTAGE AND TEMPERATURE**

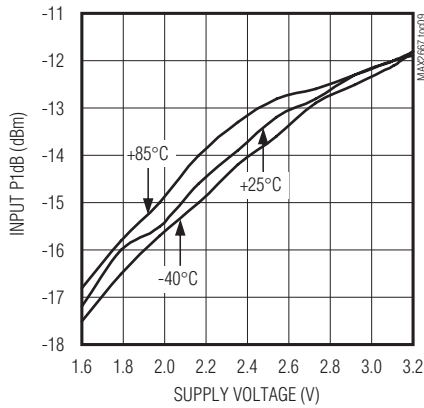

**MAX2669 INPUT P1dB COMPRESSION vs. SUPPLY VOLTAGE AND TEMPERATURE**

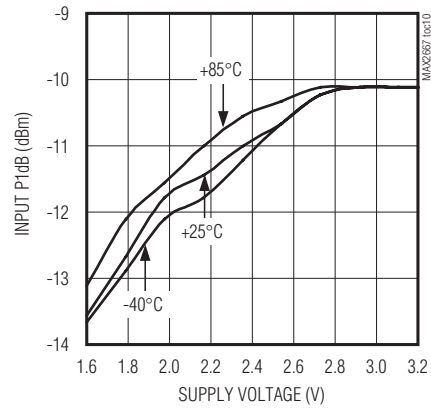

# GPS/GNSS Ultra-Low-Noise-Figure LNAs

MAX2667/MAX2669

## Bump Configuration

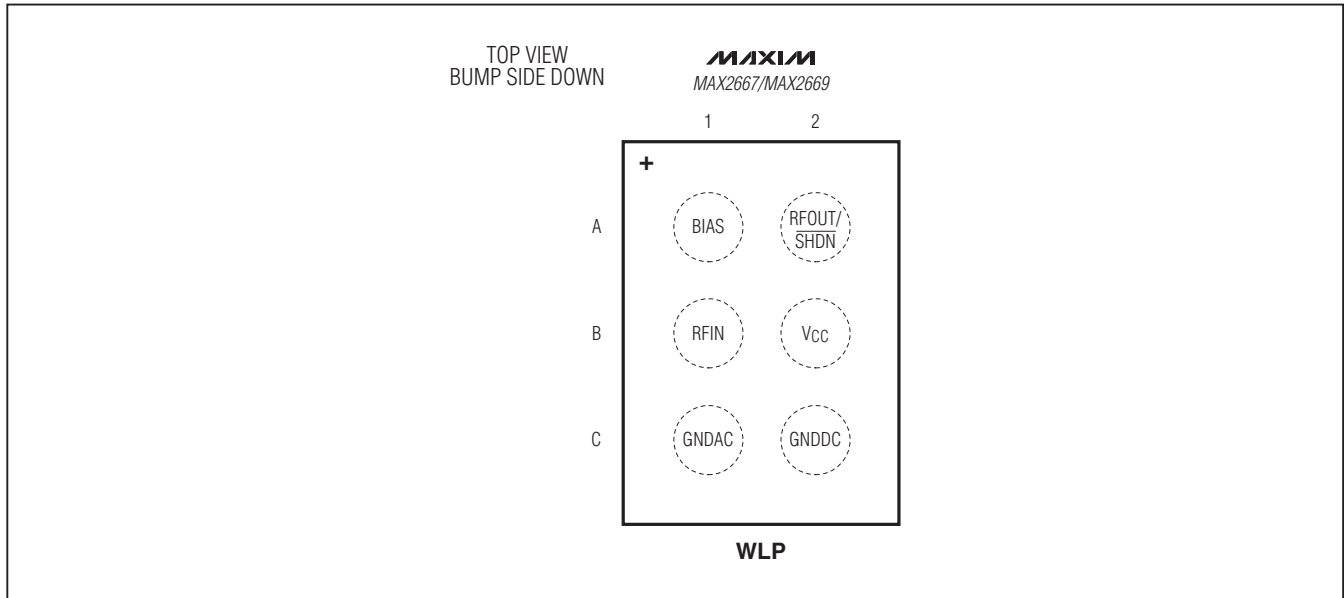

## Bump Description

BUMP	NAME	FUNCTION
A1	BIAS	Provides Bias for LNA Input. Connect to B1 (RFIN) through a high-value inductor (100nH), and bypass to ground close to the pin.
A2	RFOUT/ $\overline{\text{SHDN}}$	RF Output and $\overline{\text{SHDN}}$ Logic Input. RFOUT is internally matched to 50 $\Omega$ and has an internal DC-blocking capacitor. The $\overline{\text{SHDN}}$ logic input is coupled through a 25k $\Omega$ resistor.
B1	RFIN	RF Input. Connect to A1 through bias choke, and connect matching network and DC-blocking capacitor.
B2	VCC	Supply Voltage. Bypass to ground with a capacitor close to the IC.
C1	GNDAC	Ground of the RF Path. Connect to the 2nd-layer PCB ground plane with a via next to the pin pad.
C2	GNDDC	Ground of Bias Circuit. Connect to the 2nd-layer PCB ground plane with a <b>separate</b> via from pin C1. Sharing a ground via with pin C1 might cause stability problems.

### Detailed Description

The MAX2667/MAX2669 are LNAs designed for GPS L1, Galileo, and GLONASS applications. The devices feature a power-shutdown control mode to eliminate the need for an external supply switch. The devices achieve a high gain and an ultra-low noise figure.

### Input and Output Matching

The devices require an off-chip input matching. Only an inductor in series with a DC-blocking capacitor is

needed to form the input matching circuit. The *Typical Application Circuit* shows the recommended input-matching network. These values are optimized for the best simultaneous gain, noise figure, and return loss performance. Tables 1 and 2 list typical device S parameters and  $K_f$  values. The devices integrate an on-chip output matching to 50 $\Omega$  at the output, eliminating the need for external matching components. The value of the input coupling capacitor affects IIP3. A smaller coupling capacitor results in lower IIP3.

# GPS/GNSS Ultra-Low-Noise-Figure LNAs

## Shutdown

The devices include a shutdown feature to turn off the entire chip. Apply a logic-high to the SHDN pin to place the part in the active mode, and a logic-low to place the part in the shutdown mode.

## Applications Information

A properly designed PCB is essential to any RF micro-wave circuit. Use controlled-impedance lines on all high-frequency inputs and outputs. Bypass VCC with

decoupling capacitors located close to the device. For long VCC lines, it may be necessary to add decoupling capacitors. Locate these additional capacitors further away from the device package. Proper grounding of the GND\_ pins is essential. If the PCB uses a topside RF ground, connect it directly to the GND\_ pins. For a board where the ground is not on the component layer, connect the GND\_ pins to the board with multiple vias close to the package.

**Table 1. MAX2667 Typical Device S-Parameter Values and K-Factor**

FREQ. (MHz)	S11 MAG (dB)	S11 PHASE (Degrees)	S21 MAG (dB)	S21 PHASE (Degrees)	S12 MAG (dB)	S12 PHASE (Degrees)	S22 MAG (dB)	S22 PHASE (Degrees)	K <sub>f</sub>
1000	-2.0	-47.7	6.0	-100.0	-47.5	-148.0	-1.0	-55.0	5.1
1100	-2.1	-48.6	7.4	-100.6	-45.7	-150.0	-1.0	-58.1	3.8
1200	-2.2	-51.6	9.6	-107.3	-42.9	-153.5	-1.4	-65.4	3.1
1300	-2.4	-55.0	12.0	-117.2	-39.6	-160.2	-2.1	-74.1	2.5
1400	-2.7	-58.6	14.0	-129.5	-37.0	-168.5	-3.6	-85.5	2.3
1500	-6.5	-61.9	16.2	-146.5	-34.1	178.5	-7.4	-100.0	2.8
1575	-4.3	-62.3	17.1	-164.2	-32.9	162.8	-15.3	-100.8	2.1
1600	-4.6	-61.6	17.3	-170.6	-32.8	156.6	-20.6	-78.9	2.0
1700	-5.4	-55.3	17.1	165.5	-32.5	136.5	-9.5	10.0	1.8
1800	-5.2	-49.8	15.7	145.8	-33.8	121.6	-4.5	-2.4	1.6
1900	-4.8	-47.3	13.9	135.2	-35.2	113.8	-2.7	-13.2	1.6
2000	-4.5	-46.7	12.7	127.3	-36.7	109.6	-1.8	-21.2	1.5

**Table 2. MAX2669 Typical Device S-Parameter Values and K-Factor**

FREQ. (MHz)	S11 MAG (dB)	S11 PHASE (Degrees)	S21 MAG (dB)	S21 PHASE (Degrees)	S12 MAG (dB)	S12 PHASE (Degrees)	S22 MAG (dB)	S22 PHASE (Degrees)	K <sub>f</sub>
1000	-3.0	-57.0	10.8	-120.0	-43.0	-154.0	-1.3	-65.0	3.2
1100	-3.3	-58.2	11.6	-124.5	-42.1	-155.0	-1.6	-70.2	3.3
1200	-3.5	-60.0	13.4	-134.6	-39.3	-160.5	-2.4	-79.6	2.8
1300	-3.8	-62.3	14.9	-148.0	-37.2	-168.3	-4.0	-90.0	2.7
1400	-4.3	-63.3	15.9	-162.3	-35.4	-178.2	-7.3	-101.0	2.7
1500	-4.9	-62.0	16.6	-178.9	-33.9	171.0	-14.5	-100.6	2.6
1575	-5.3	-59.7	16.6	168.0	-33.5	161.7	-19.6	-26.0	2.5
1600	-5.4	-58.5	16.5	163.9	-33.6	157.5	-16.7	-6.0	2.5
1700	-5.5	-53.7	15.8	149.3	-33.6	148.3	-9.0	3.6	2.3
1800	-5.3	-50.3	14.7	136.8	-34.2	142.5	-5.7	-2.8	2.2
1900	-5.1	-48.0	13.4	130.0	-35.1	139.6	-4.0	-9.6	2.3
2000	-4.9	-46.3	12.7	123.9	-35.8	138.6	-3.0	-15.0	2.1

# GPS/GNSS Ultra-Low-Noise-Figure LNAs

MAX2667/MAX2669

**Table 3. MAX2667 Typical Noise Parameters (VCC = 2.85V, TA = +25°C)**

FREQUENCY (MHz)	FMIN (dB)	Γ <sub>OPT</sub>	Γ <sub>OPT</sub>   ANGLE	R <sub>N</sub> (Ω)
1550	0.54	0.48	39.9	8.43
1560	0.55	0.48	40.2	8.42
1570	0.55	0.48	40.5	8.41
1575	0.55	0.48	40.7	8.41
1580	0.55	0.48	40.9	8.40
1590	0.55	0.48	41.2	8.39
1600	0.55	0.48	41.5	8.38

**Table 4. MAX2669 Typical Noise Parameters (VCC = 2.85V, TA = +25°C)**

FREQUENCY (MHz)	FMIN (dB)	Γ <sub>OPT</sub>	Γ <sub>OPT</sub>   ANGLE	R <sub>N</sub> (Ω)
1550	0.57	0.29	76.1	4.53
1560	0.57	0.29	76.6	4.53
1570	0.57	0.29	77.0	4.53
1575	0.57	0.29	77.3	4.52
1580	0.57	0.29	77.5	4.52
1590	0.57	0.29	78.0	4.52
1600	0.57	0.29	78.5	4.52

## Chip Information

PROCESS: SiGe BiCMOS

## Package Information

For the latest package outline information and land patterns, go to [www.maxim-ic.com/packages](http://www.maxim-ic.com/packages). Note that a "+", "#", or "-" in the package code indicates RoHS status only. Package drawings may show a different suffix character, but the drawing pertains to the package regardless of RoHS status.

PACKAGE TYPE	PACKAGE CODE	OUTLINE NO.	LAND PATTERN NO.
6 WLP	W61B1+1	<a href="#">21-0217</a>	—

# **GPS/GNSS Ultra-Low-Noise-Figure LNAs**

## **Revision History**

<b>REVISION NUMBER</b>	<b>REVISION DATE</b>	<b>DESCRIPTION</b>	<b>PAGES CHANGED</b>
0	9/10	Initial release	—

*Maxim cannot assume responsibility for use of any circuitry other than circuitry entirely embodied in a Maxim product. No circuit patent licenses are implied. Maxim reserves the right to change the circuitry and specifications without notice at any time.*

**8 \_\_\_\_\_ Maxim Integrated Products, 120 San Gabriel Drive, Sunnyvale, CA 94086 408-737-7600**

© 2010 Maxim Integrated Products

Maxim is a registered trademark of Maxim Integrated Products, Inc.